

VELKOMMEN TIL 19. KATALOG

ROYKON har hermed fornøjelsen af at fremsende 19. udgave af vores katalog, der omhandler mere end 40.000 forskellige komponenter.

På vores top moderne lager med semi-automatiske robotter har vi igennem mange år opbygget et substantielt lager og vi har en leveringssikkerhed på 98 % på dag-til-dag leveringer.

Vi ekspederer mere end 18.000 enheder om dagen.

Vi har over 170 leverandører, der alle er specielt udvalgt efter flere kriterier, hvor fx leveringssikkerhed, kvalitet og design har højeste prioritet.

Du kan roligt købe dine produkter fra ROYKON – vi vil gøre alt for, at du bliver en tilfreds kunde.

Tusind tak for tilliden til ROYKON AS og vi ser frem til at høre fra dig.

Med venlig hilsen
Team ROYKON AS

53 CLAMP FITTINGS



61 FØDEVAREFITTINGS



87 KOBLINGER



147 KOMPRESSION FITTINGS



171 MANOMETRE & FLOWMETRE



193 PLAST FITTINGS



241 PNEUMATIK & LUFTBEHANDLING



367 PREFITTINGS



379 PUMPER, TANKE- & BEHOLDERE TILBEHØR



389 RUSTFRI FITTINGS



461 RØR, RØRHOLDERE, BOLTE & SKRUER

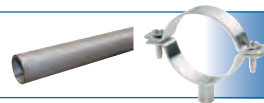

495 SLANGEFITTINGS & SLANGER

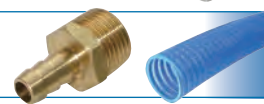

553 SORT, GALV, MESSING & ALU FITTINGS



583 SPULEUDSTYR



595 SPÆNDEBÅND



607 SVEJSEFITTINGS



623 TILBEHØR

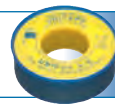

643 VAND & SPILDEVAND



709 VANDFILTRE



725 VENTILER



791 VIBRATIONSDÆMPERE & MASKINFØDDER

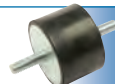

LAD OS HØRE FRA DIG

ROYKON AS har bred erfaring i levering af specialkomponenter i rustfri og messing. Vi kan tilbyde serier fra 100 til mange 100.000 enheder.

De fabrikker, vi får produceret på, besøges i gennemsnit en gang om året. Vi har igennem årene haft et langt udskillelsesløb, hvor de fabrikker, vi bruger i dag, er fabrikker med meget høje standarder og kvalitetskrav.

Vi tilbyder at give en hurtig pris på dine specialkomponenter og på pro-

duktionssiden betyder det, at vi i udviklingsfasen har lynhurtig tilbagemelding og at kvaliteten af produkterne er, som vores kunder har specificeret.

Vores leverandører er miljøbeviste, benytter ikke børnearbejde og har ordnede forhold for alle medarbejdere.

Således føler vi os nu rustet til at levere kvalitetsfittings til virksomheder, for hvem kvalitet er en selvfølge og hvor miljø og social bevidsthed har betydning.

**RING FOR ET
UFORPLIGTENDE
BESØG PÅ TELEFON:**

75 945 955



CLAMP FITTINGS

CLAMP FITTINGS GALVANISERET



CLAMP TILBEHØR

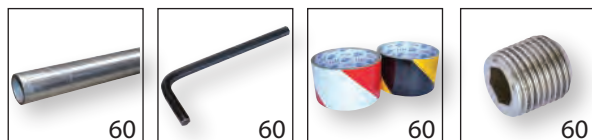

FØDEVAREFITTINGS

PUSH-IN FITTINGS RUSTFRI AISI 316



PUSH-ON FITTINGS RUSTFRI AISI 316



PUSH-IN FITTINGS MESSING FØDEVAREGODKENDT



SLANGER TIL FØDEVARER

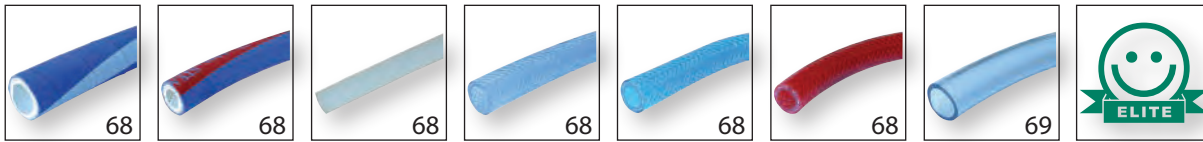

SVEJSEUNIONER RUSTFRI TIL MEJERI



SVEJSEFITTINGS RUSTFRI TIL MEJERI



SVEJSEFITTINGS ISO RUSTFRI



SVEJSEFITTINGS DIN RUSTFRI

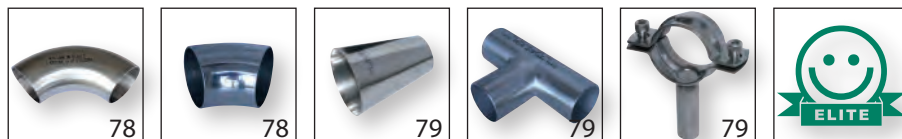

PUSH-IN FITTINGS POM



VENTILER FØDEVAREGODKENDT

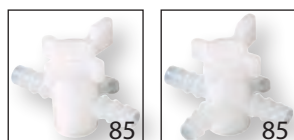

KOBLINGER

CAMLOCK KOBLINGER RUSTFRI AISI 316

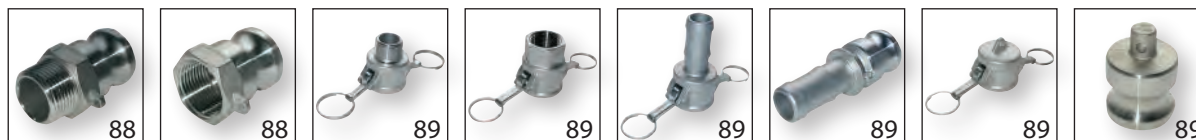

CAMLOCK KOBLINGER RUSTFRI AISI 316 MED LÅS



CAMLOCK KOBLINGER ALUMINIUM

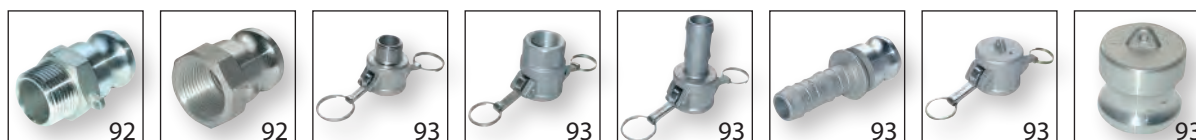

CAMLOCK KOBLINGER MESSING



CAMLOCK KOBLINGER PP



CAMLOCK KOBLINGER NYLON

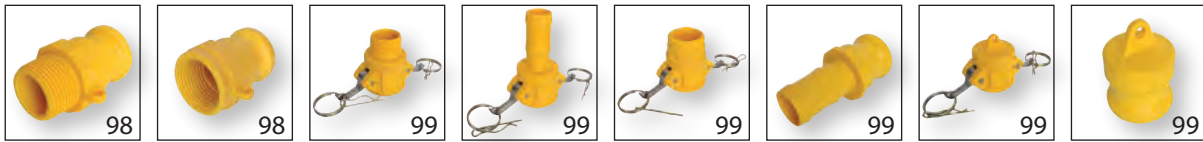

CAMLOCK TILBEHØR



KLOKOBLINGER TIL VAND "TYPE GEKA"



KLOKOBLINGER TIL LUFT



NITO KOBLINGER TIL VAND





GEKA LYNKOBLINGER TIL VAND



SLANGESTUDSKOBLINGER MESSING



TW KOBLINGER



STORZ KOBLINGER

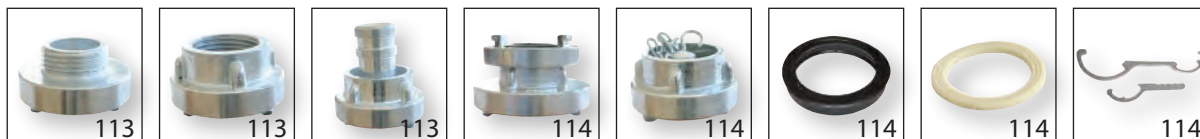

SLANGEKOBLINGER

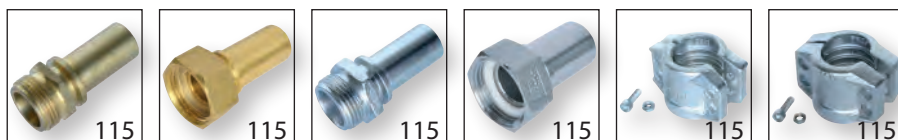

KOBLINGER TYPE "BAUER"

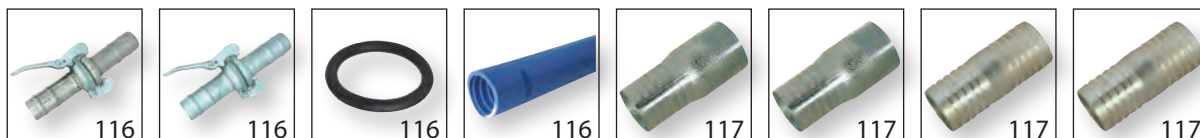

LYNKOBLING SERIE 200 MINI

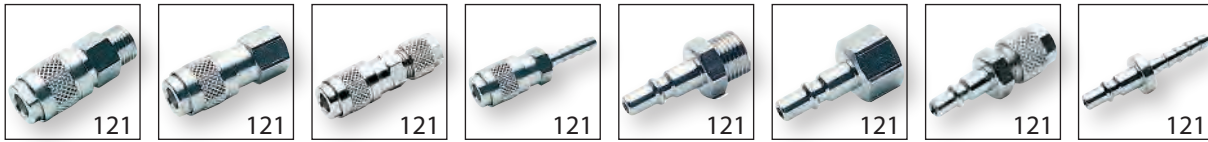

LYNKOBLING SERIE 210 MIGNON



LYNKOBLING SERIE 210 MIGNON DOBBELT



LYNKOBLING SERIE 220 NORMA

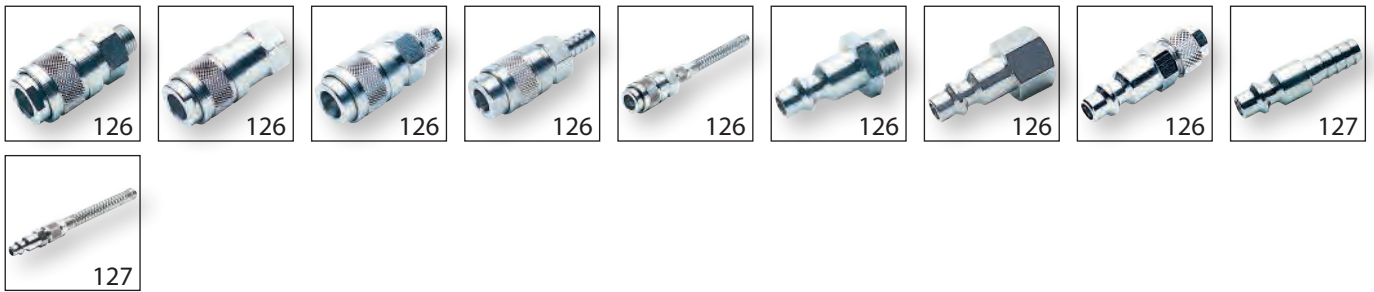

LYNKOBLING SERIE 230 NORMA



LYNKOBLING SERIE 240 NORMA

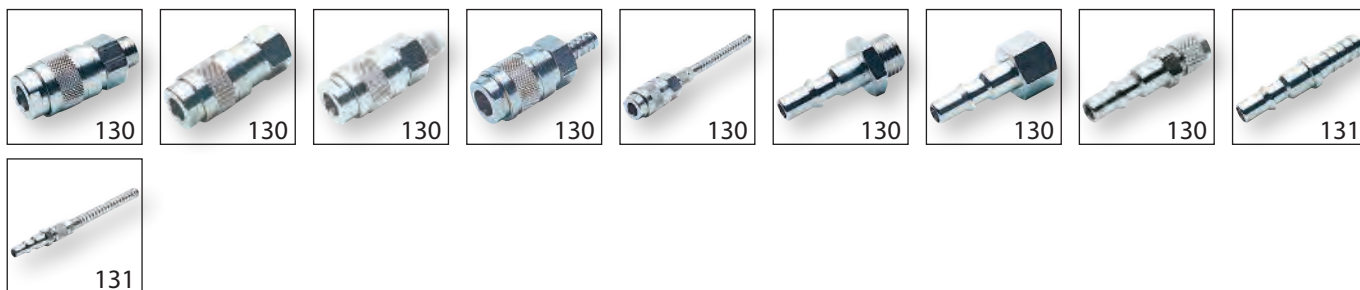

LYNKOBLING SERIE 260 TEDESCO DE MEST BRUGTE KOBLINGER I NORDEN



LYNKOBLING SERIE 520 JWJ



LYNKOBLING SERIE 270 SVENSK



LYNKOBLING SERIE 410-510



LYNKOBLING SERIE 660 EUROPÆISK



LYNKOBLING SERIE 670 SVENSK



LYNKOBLING SERIE 800 MINI

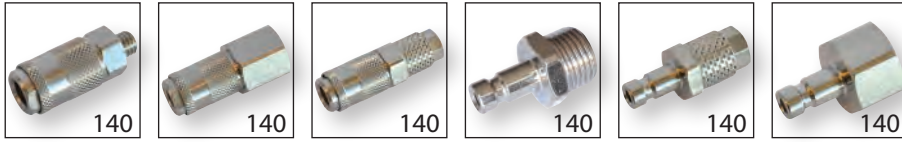

LYNKOBLING ISO B



LYNKOBLING PLASTIK

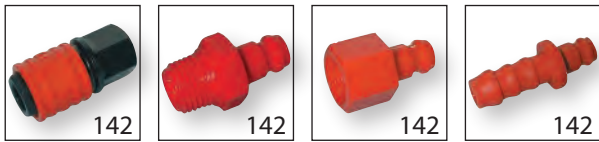

JWL KOBLINGER OG TRYKLUFTHVÆRSTREK



KOMPRESSIONS FITTINGS MESSING VA GODKENDT



KOMPRESSIONS FITTINGS PLAST VA GODKENDT



KOMPRESSION FITTINGS PLAST



KOMPRESSION FITTINGS MESSING VA-GODKENDT U/STØTTEBØSNING



KOMPRESSION FITINGS MESSING VA-GODKENDT TIL VAND



KOMPRESSION FITINGS MESSING VA-GODKENDT TIL VARME



INDUSTRIEL KOMPRESSIONS FITTINGS

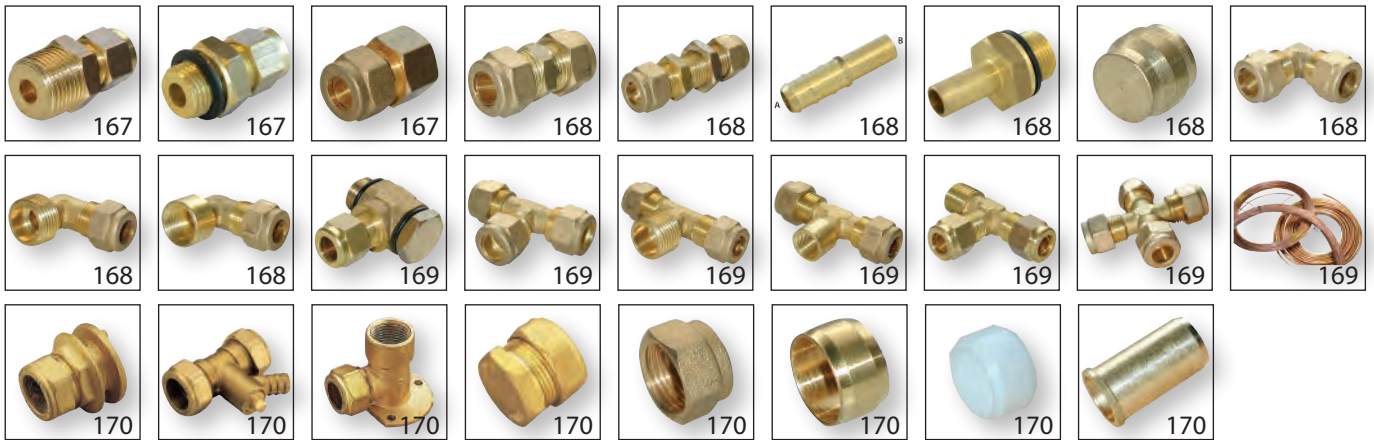

MANOMETRE RUSTFRI MED GLYCERIN



MANOMETRE PLAST



VAKUUMMETRE



TERMOMETRE

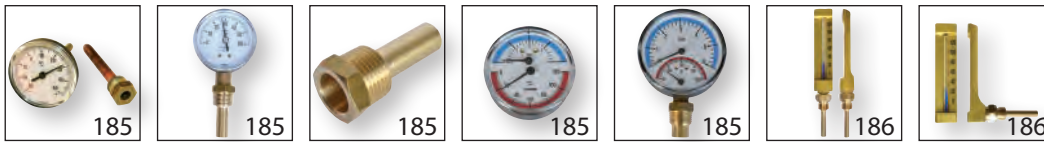

MANOMETER TILBEHØR



FLOWMETRE



GEVINDFITTINGS PP SORT



GEVINDFITTINGS NYLON 6.6 BLÅ



PUSH-ON FITTINGS PP BLÅ



PUSH-ON FITTINGS POM BLÅ



PUSH-ON FITTINGS PP



PUSH-IN FITTINGS POM



PVC RØR & TILBEHØR



PVC LIMFITTINGS



PVC FLANGER



PVC GEVINDFITTINGS



PVC LIM & GEVINDFITTINGS



ELEKTROSVEJS FITTINGS PE



STUK-EL FITTINGS

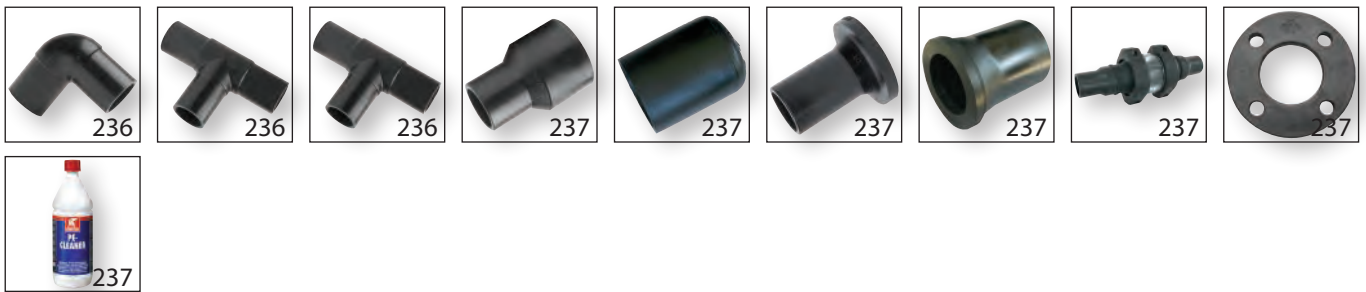

STUK FITTINGS

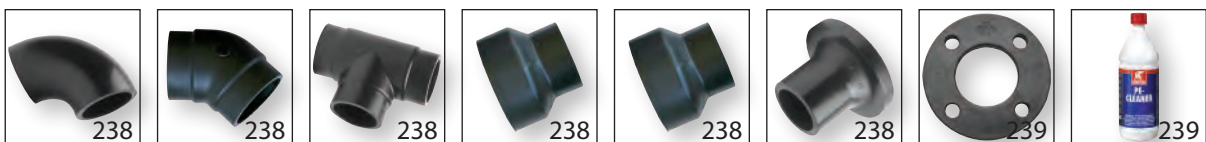

PUSH-IN FITTINGS PLAST/MESSING

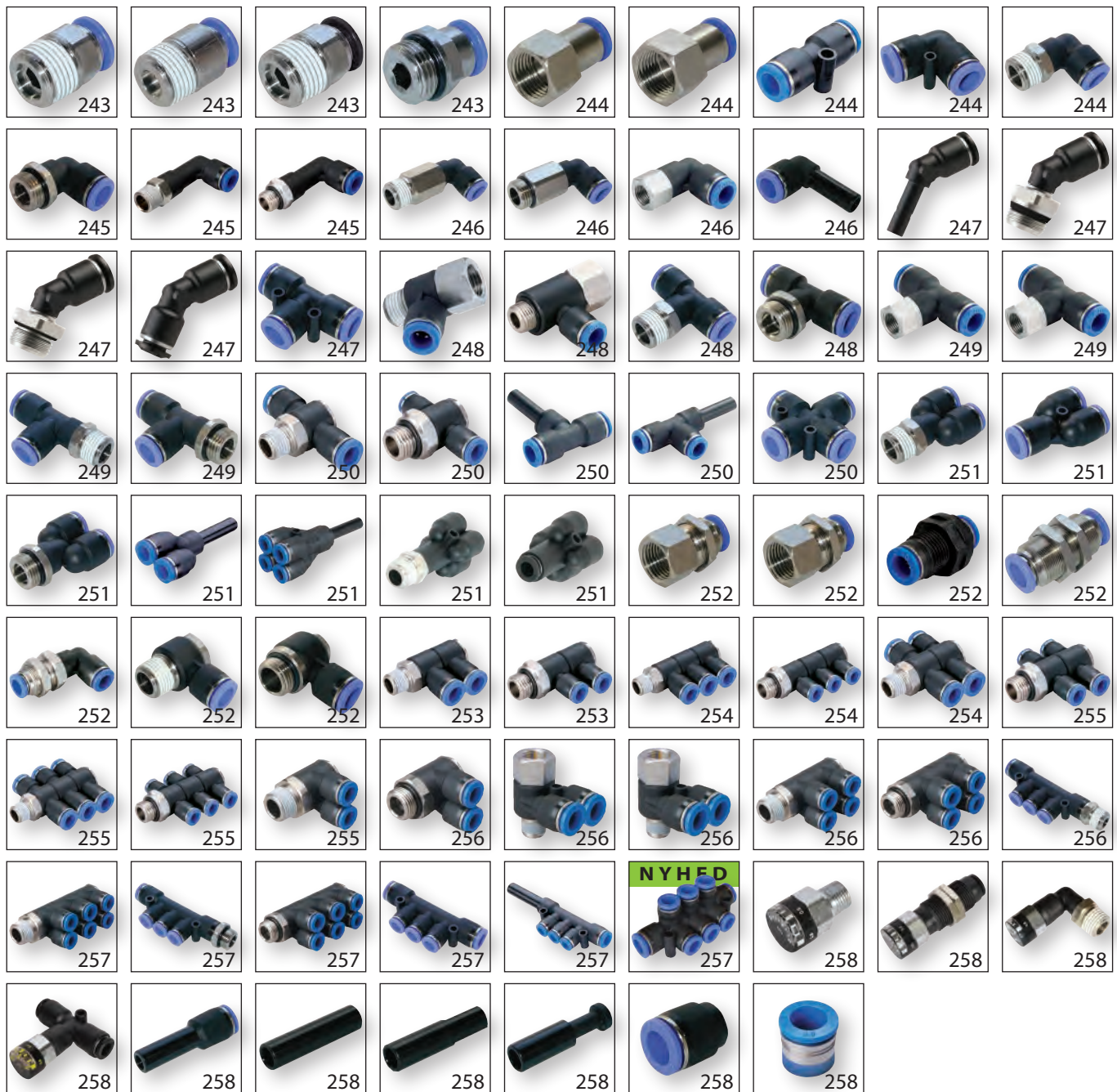

PUSH-IN FITTINGS PLAST/MESSING MINI



DRØVLEVENTILER TIL PUSH-IN



VENTILER TIL PUSH-IN



KONTRAVENTILER



STOPVENTILER



PUSH-IN FITTINGS MESSING



PUSH-ON FITTINGS MESSING



GEVINDFITTINGS MESSING TIL PNEUMATIK



LYDDÆMPERE



CYLINDRE



CYLINDRE RUSTFRI

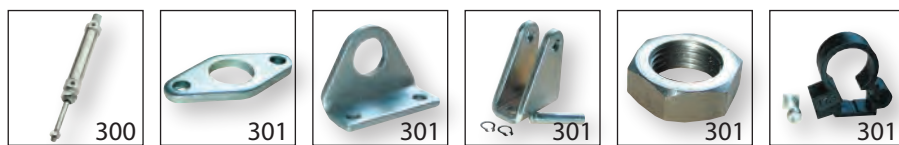

CYLINDRE ALUMINIUM

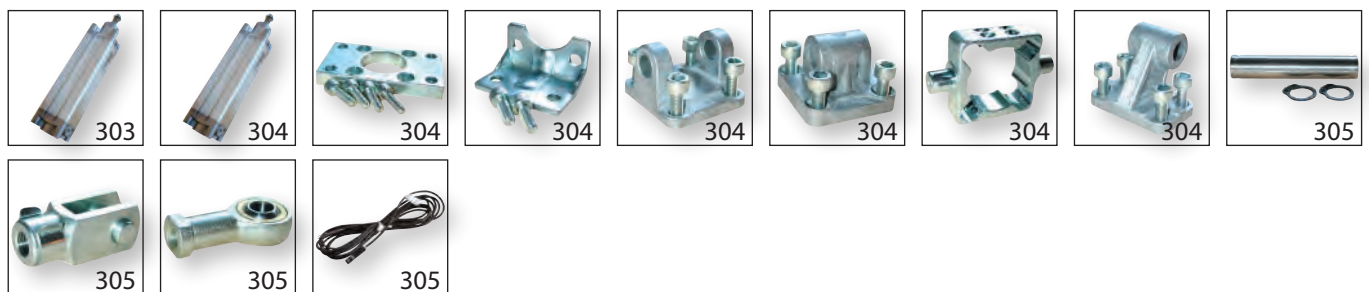

DRØVLEVENTILER



FILTER, REGULATOR & SMØREAPPARATER



FILTER, REGULATOR & SMØREAPPARATER RUSTFRI



TRYKLUFFILTRE



KOMPRESION FITTINGS MESSING



SVIVEL FITTINGS

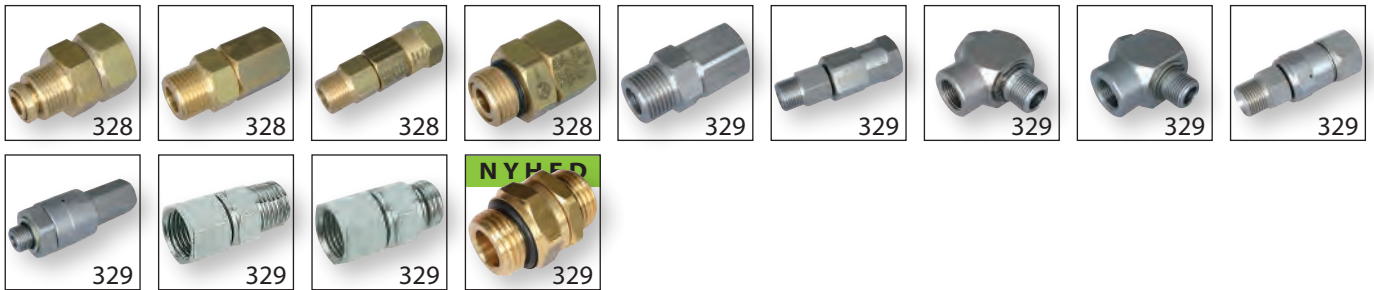

PUSH-IN FITTINGS RUSTFRI AISI 316



PUSH-IN FITTINGS MESSING HØJTRYK



STØDDÆMPERE



LYNKOBLING SERIE 200 MINI



LYNKOBLING SERIE 210 MIGNON



LYNKOBLING SERIE 210 MIGNON DOBBELT



LYNKOBLING SERIE 220 NORMA

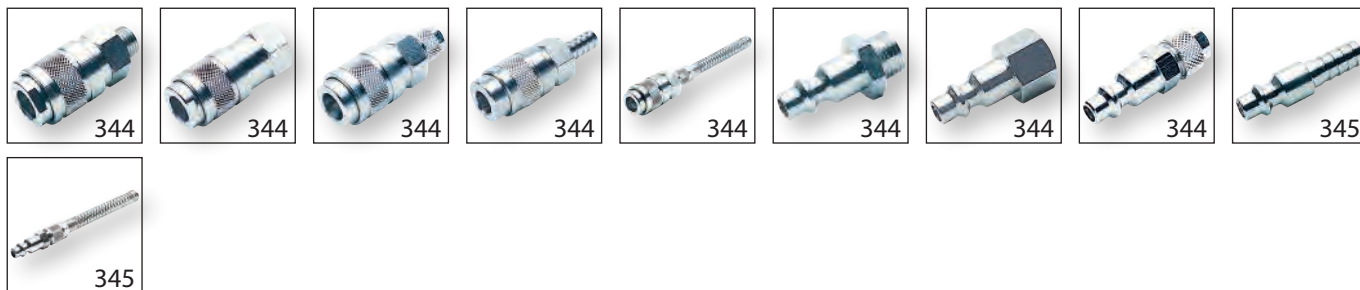

LYNKOBLING SERIE 230 NORMA



LYNKOBLING SERIE 240 NORMA



LYNKOBLING SERIE 260 TEDESCO DE MEST BRUGTE KOBLINGER I NORDEN



LYNKOBLING SERIE 520 JWJ



LYNKOBLING SERIE 270 SVENSK



LYNKOBLING SERIE 410-510



LYNKOBLING SERIE 660 EUROPÆISK



LYNKOBLING SERIE 670 SVENSK



LYNKOBLING SERIE 800 MINI



LYNKOBLING ISO B



LYNKOBLING PLASTIK

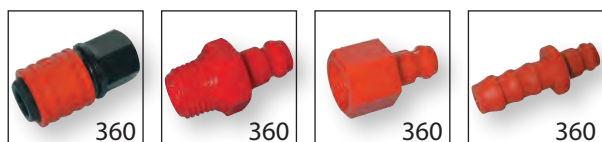

JWL KOBLINGER OG TRYKLUFTPISTOLER



PNEUMATISKE VIBRATORER

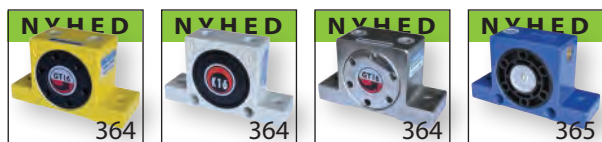

PRESFITTINGS RUSTFRI AISI 316



PRESFITTINGS STÅL FZ



PRESFITTINGS VÆRKTØJ



PUMPER & LIGN.



TANKE- OG BEHOLDERE TILBEHØR



GEVINDFITTINGS RUSTFRI AISI 316



GEVINDFITTINGS RUSTFRI AISI 316 LIGHT



MUFFER & NIPPELRØR RUSTFRI AISI 316



NPT FITTINGS RUSTFRI AISI 316



FLANGER RUSTFRI/ALU

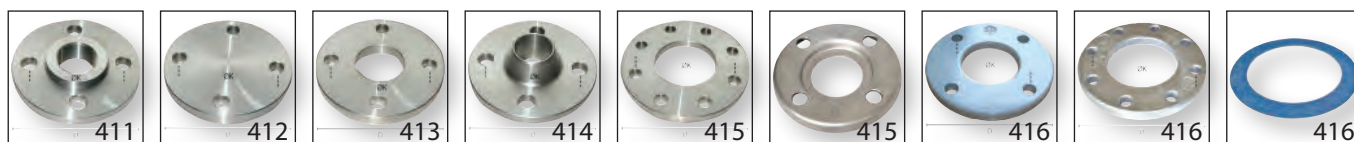

FLANGER PVC



REPARATIONSMUFFER RUSTFRI AISI 316



SKÆRERINGSFITTINGS RUSTFRI AISI 316



GEVINDFITTINGS RUSTFRI AISI 316 HØJTRYK



KLEMRINGSFITTINGS RUSTFRI AISI 316 TIL METRISKE RØR



KLEMRINGSFITTINGS RUSTFRI AISI 316 TIL TOMME RØR



PUSH-IN FITTINGS RUSTFRI AISI 316



PUSH-ON FITTINGS RUSTFRI AISI 316



RØR

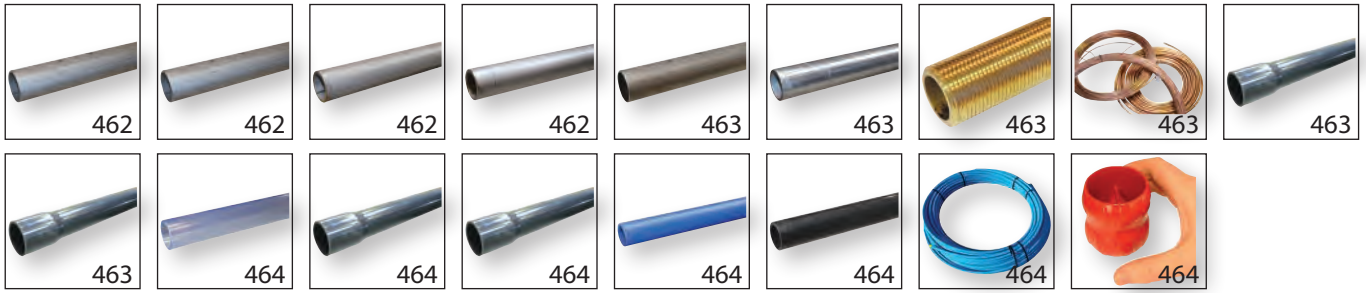

RØRHOLDERE

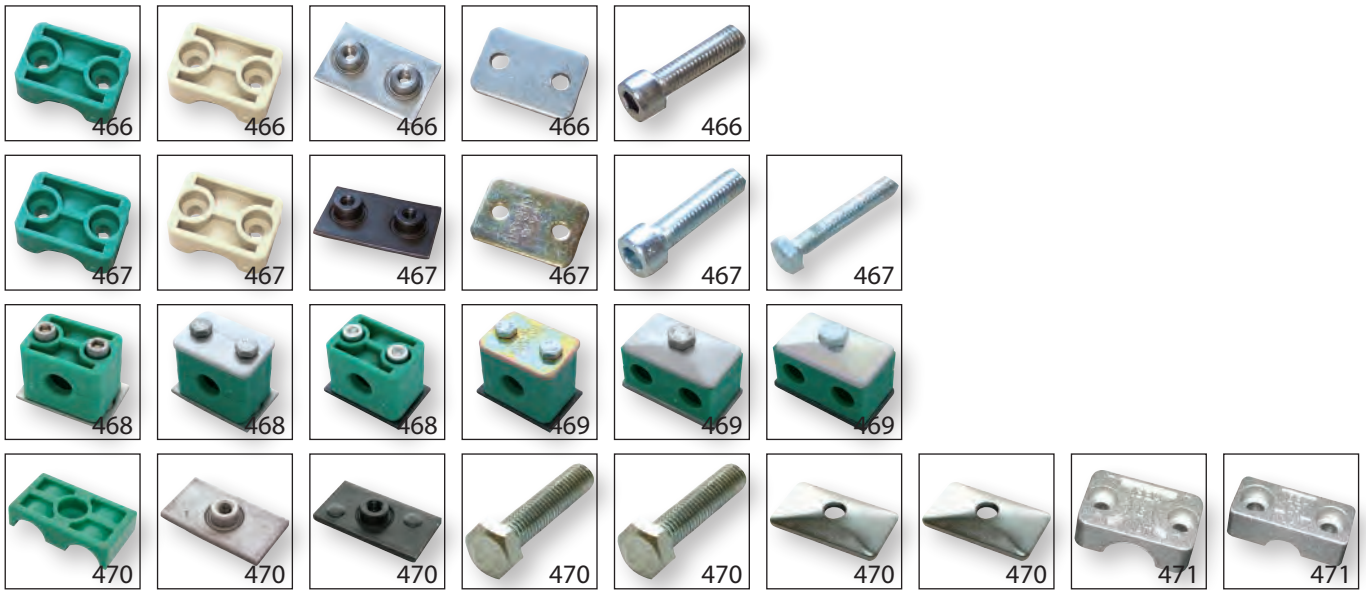

RØRHOLDERE



BOLTE & SKRUER



STRIPS

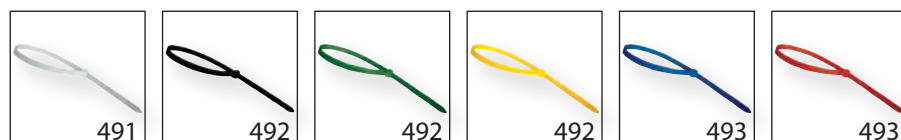

SLANGFITTINGS RUSTFRI



SLANGFITTINGS MESSING



SLANGFITTINGS GALVANISERET

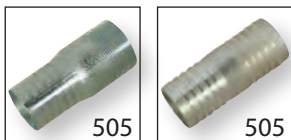

SLANGFITTINGS NYLON

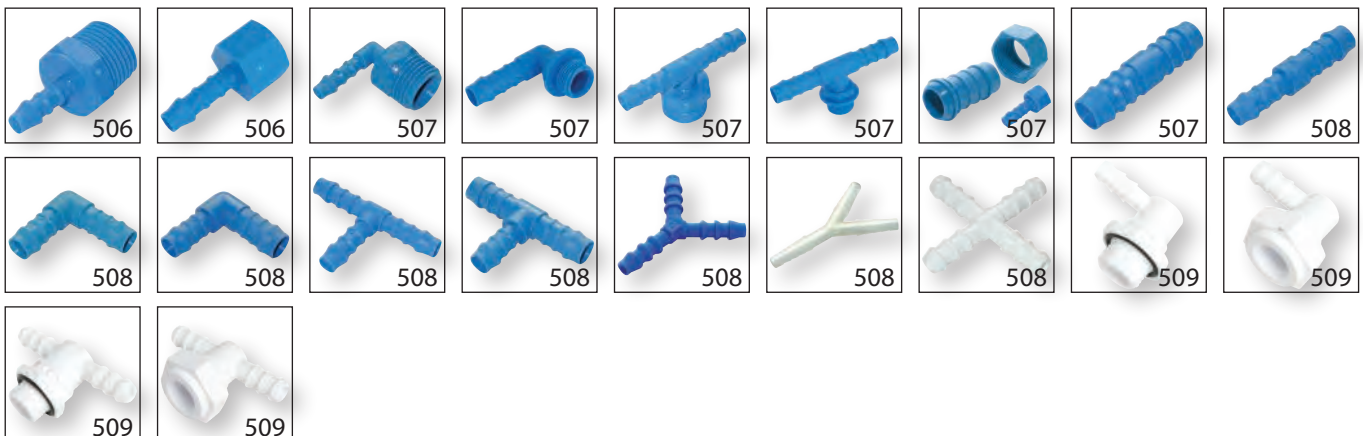

SLANGEFITTINGS PVDF



SLANGEFITTINGS NYLON NATURAL

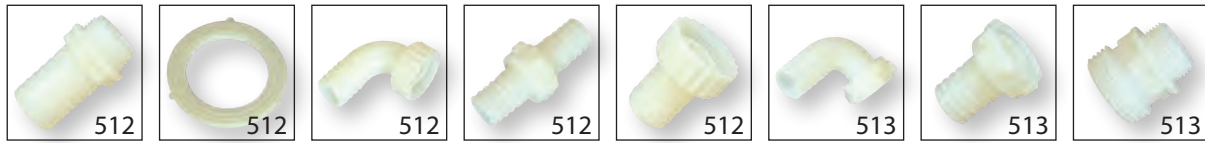

SLANGEFITTINGS PP



SLANGEFITTINGS PP GLASFIBER FORSTÆRKET



PAKNINGER

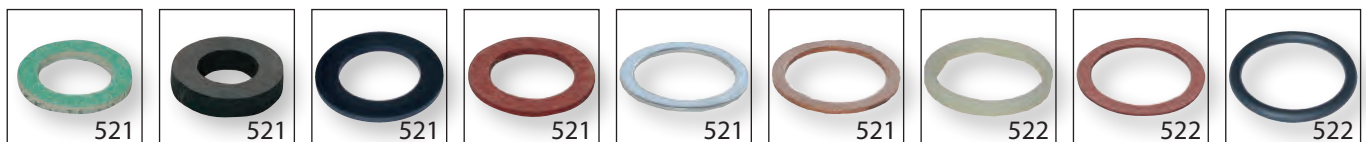

SLANGER TIL LUFT/VAND



SLANGER TIL TRYKLUF

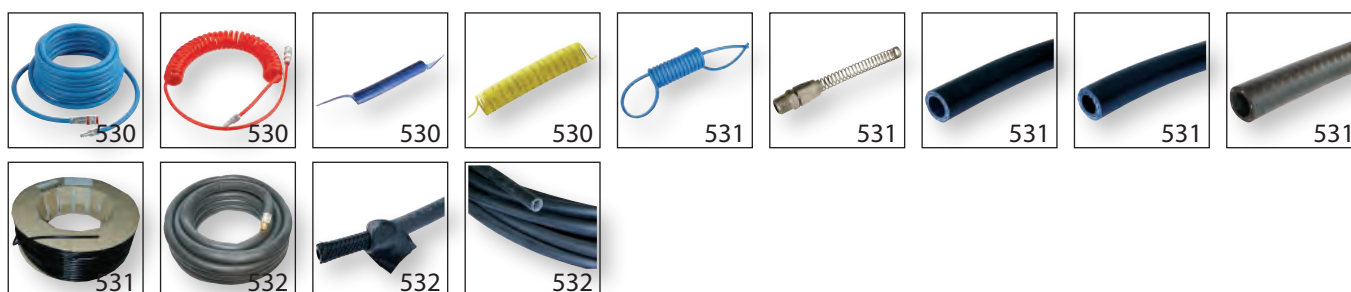

SLANGER TIL VÆSKE/VAND

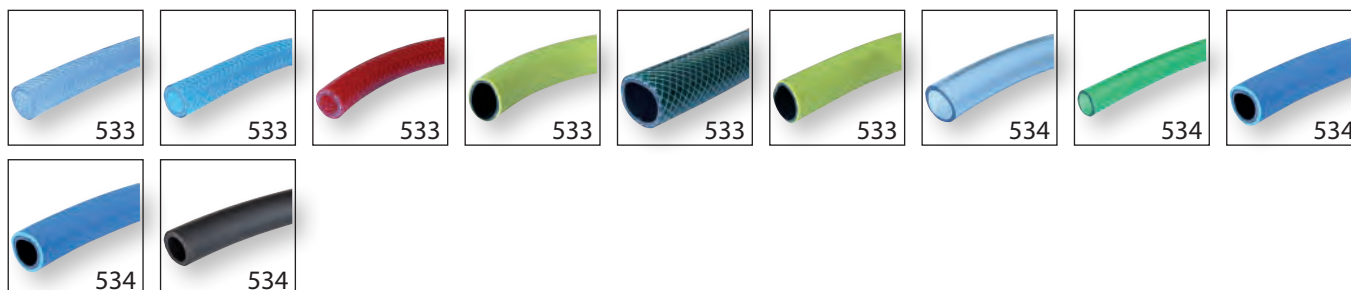

SLANGER TIL VAKUUM OG TRYK

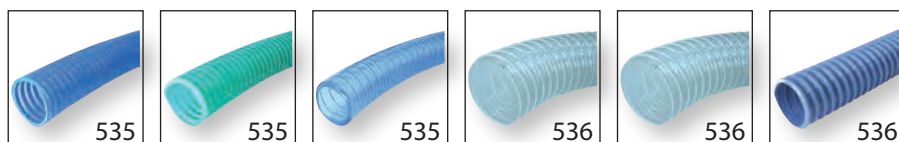

SLANGER TIL AFLØB OG FORURENDE VÆSKER

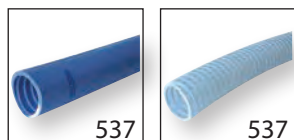

SLANGER TIL SVØMMEBASSIN OG SANITET

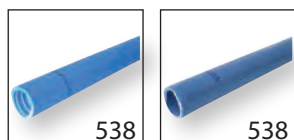

SLANGER TIL BRAND/ENTREPRENØR



SLANGER TIL FØDEVARER/KEMI

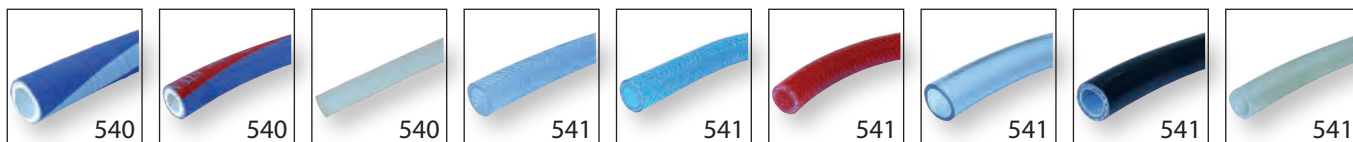

SLANGER TIL DAMP



SLANGER TIL OLIE

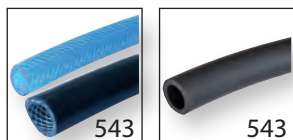

SLANGER TILBEHØR



SLANGER TIL KØLEVÆSCKE



GEVINDFITTINGS SORT



GEVINDFITTINGS GALVANISERET



GEVINDFITTINGS MESSING



GEVINDFITTINGS MESSING AFZINKNINGSBESTANDIG VA

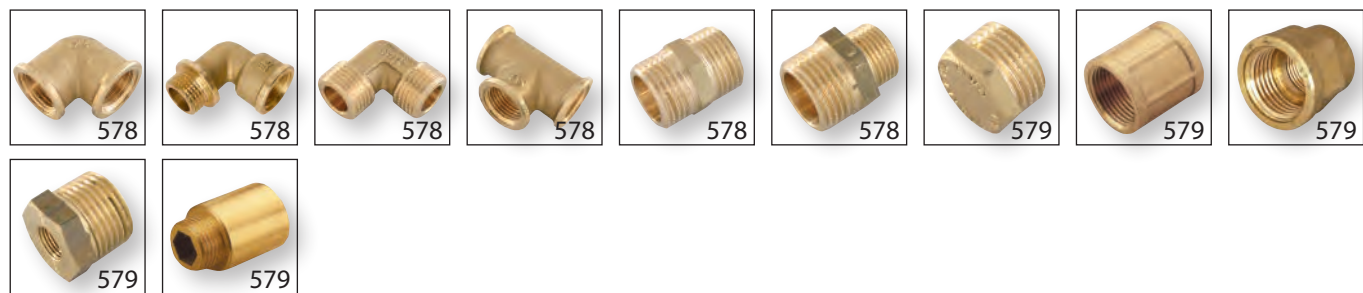

GEVINDFITTINGS BRONZE



GEVINDFITTINGS SORT ALU



INDUSTRIPISTOLER



SVIVELER



NITO KOBLINGER



SPULEUDSTYR TILBEHØR

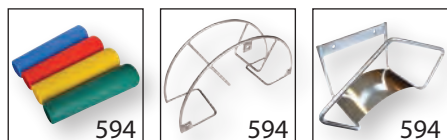

SPÆNDEBÅND

SPÆNDERINGE



SPÆNDEBÅND



TILBEHØR TIL SPÆNDEBÅND



SVEJSEFITTINGS

SVEJSEFITTINGS RUSTFRI AISI 316



SVEJSEFITTINGS ISO RUSTFRI

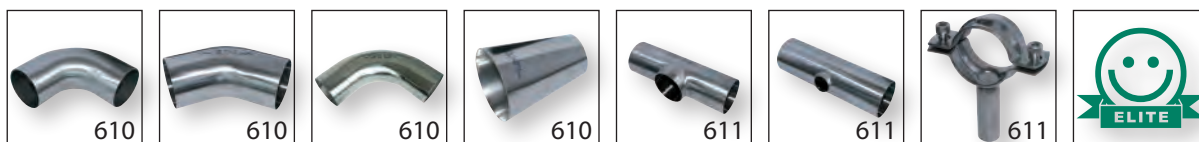

SVEJSEFITTINGS DIN RUSTFRI



SVEJSEUNIONER RUSTFRI TIL MEJERI



SVEJSEFITTINGS RUSTFRI TIL MEJERI

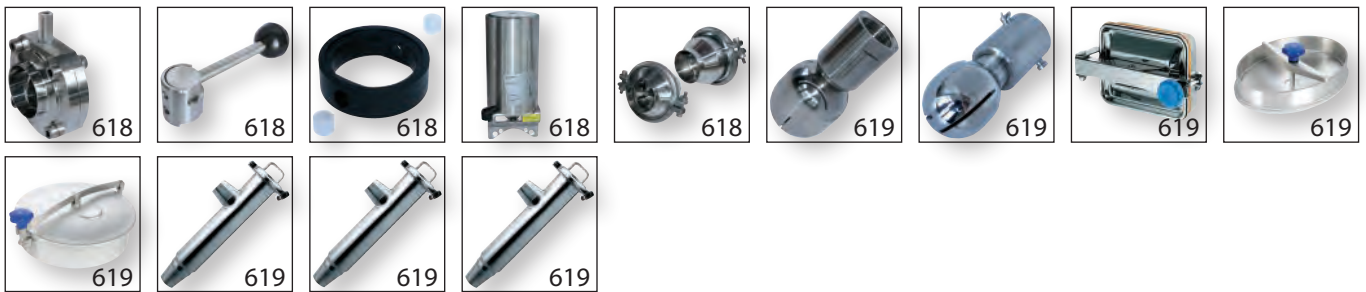

SVEJSEFITTINGS ALU SØVANDSBESTANDIG

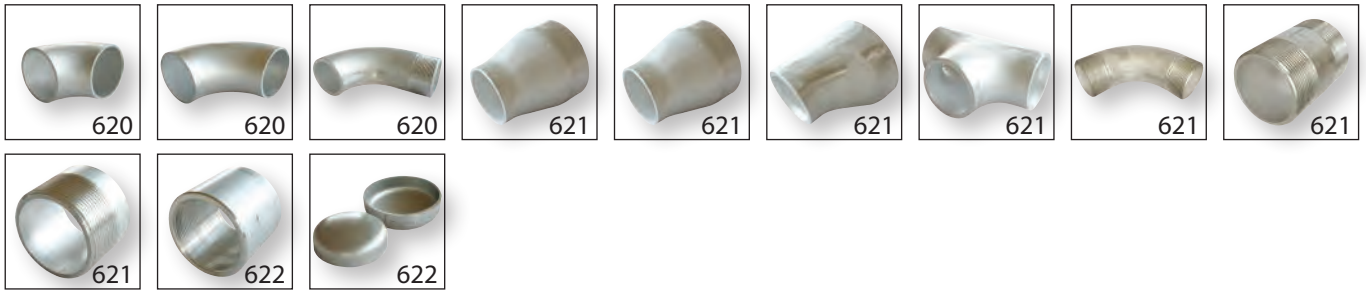

TILBEHØR

FITTINGS TILBEHØR



STRIPS

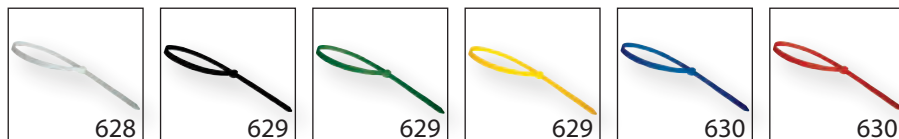

SIKKERHEDSUDSTYR



ARBEJDSHANDSKER



SLUSER OG MÅTTER



VAND: SKYDEVENTILER

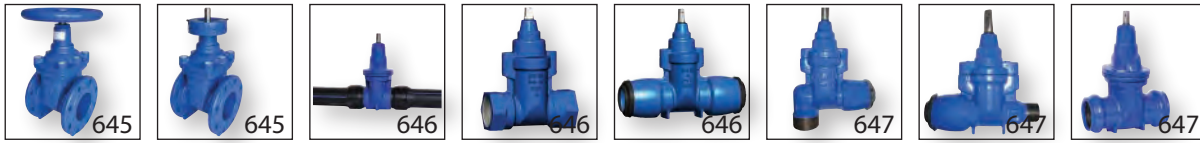

VAND: SKYDEVENTILER TILBEHØR

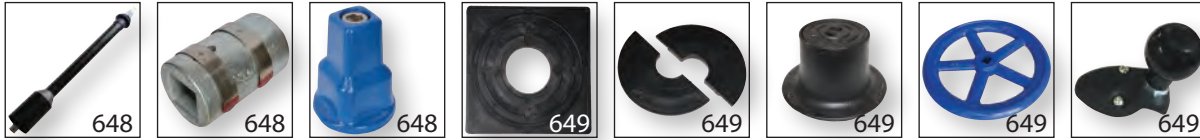

VAND: BUTTERFLYVENTILER



SPILDEVAND: SKYDEVENTILER



SPILDEVAND: SKYDEVENTILER TILBEHØR



SPILDEVAND: SPADEVENTILER



SPLDEVAND: KONTRAVENTILER



KUGLEHNER RUSTFRI



AKTUATORER OG TILBEHØR



KOBLINGER TIL VAND OG SPLDEVAND



KOBLINGER RUSTFRI TIL VA



ANBORINGER



KOMPENSATORER

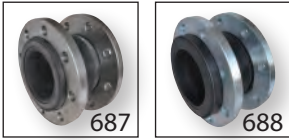

687

688

STØBEJERNSFITTINGS

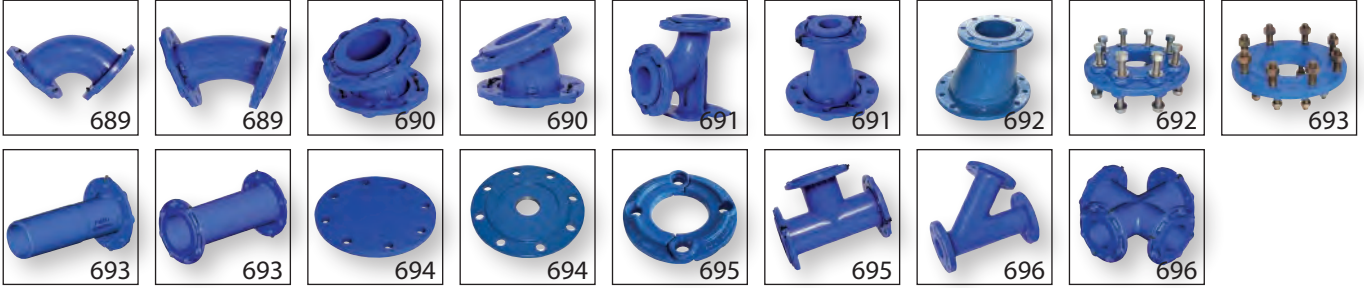

689

689

690

690

691

691

692

692

693

693

693

694

694

695

695

696

696

UDLØBSKLAPPER



697

697

698

698

698

PAKNINGER TIL VAND & SPILDEVAND



699

699

700

700

RØRGENNEMFØRINGER



701

703

705

705

706

706

RENSEGRISE

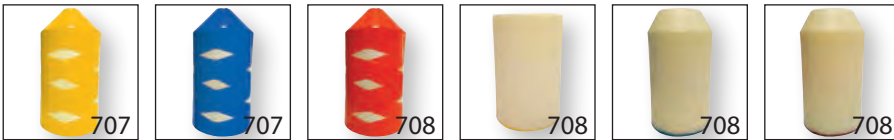

707

707

708

708

708

708

VANDFILTRE

STANDARD FILTRE



710

710

711

711

711

712

712

712

712

HOT FILTRE

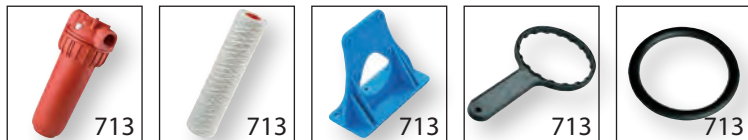

MINI FILTRE



FILTRE MED DRÆN



BIG FILTRE



BIG SANI FILTRE

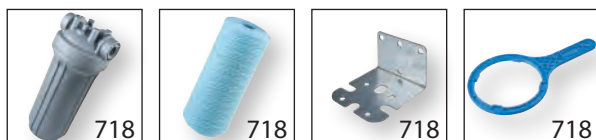

DIVERSE FILTRE



KUGLEHANER RUSTFRI AISI 316



VENTILER RUSTFRI AISI 316



KUGLEHANER MESSING



VENTILER MESSING





VENTILER MESSING MINI



VENTILER PLAST



VENTILER PVC



VENTILER PP



KONTRAVENTILER RUSTFRI



KONTRAVENTILER MESSING



KONTRAVENTILER PLAST



SIKKERHEDSVENTILER



MAGNETVENTILER

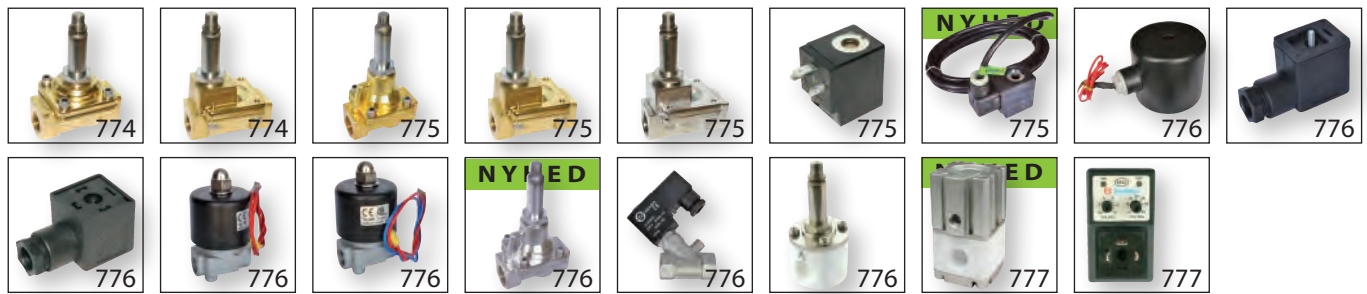

LUFTSTYRINGSVENTILER



KUGLEHANER PNEUMATISKE RUSTFRI AISI 316

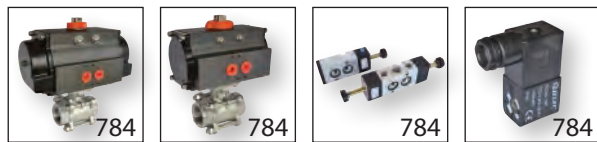

KUGLEHANER EL-STYREDE RUSTFRI AISI 316



PNEUMATVENTILER SKRÅ RUSTFRI AISI 316



PNEUMATVENTILER LIGE RUSTFRI AISI 316



VIBRATIONSDÆMPERE CYLINDRISKE

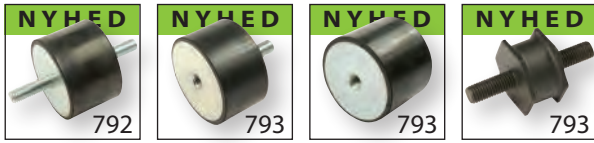

BUFFERE OG STOPKLODSE



DIVERSE DÆMPERE



ANTI-VIBRATIONS BØSNINGER



SIKREDE & MARINE SVINGNINGSDÆMPERE



DÆMPERE MED FLANGE



SANDWICH DÆMPERE

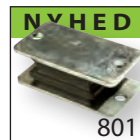

MASKINSKO

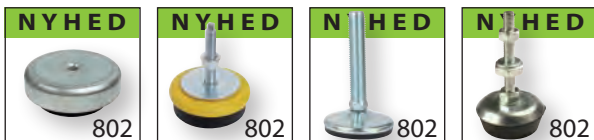

HVAC & LOFT- OPHÆNGTE DÆMPERE



CLAMP FITTINGS



54

CLAMP FITTINGS
GALVANISERET



60

CLAMP TILBEHØR

CLAMP FITTINGS GALVANISERET



Denne type clamps er kompatibel med Kee Klamp. Serien lagerføres fra 1/2" til 2". I programmet findes også Unbrako nøgler og diverse advarselstape.

Galvaniserede rør og fittings bruges typisk til brugsvandsinstallationer, da galvaniserede vandrør er særligt godt beskyttet mod korrosion. Er du på udkig efter et stort udvalg af galvaniserede fittings, så kan du finde det her på siden. Vi forhandler kun de bedste producenter på markedet.

De fleste steder har man adgang til rør og kan løse de fleste konstruktionsopgaver, hvis blot man får rørene samlet, så de fremstår som en samlet forsvarlig enhed. Det er præcis dét, som vores clamp fittings gør. Hér er det manglende led, der får utallige løsninger op at stå i ordets bogstaveligste forstand. Vel at mærke så solidt, at konstruktionen holder til de belastninger, der var forudsætningerne fra starten. Galvaniserede fittings findes i alle tænkelige variationer. Samlinger, hjørner, led og kryds. Det er næsten umuligt at

finde en vinkel, hvor systemet ikke kan få samling på rørene. Når de nødvendige fittings er på plads, er det eneste værktøj, det kræver for at stramme den justerbare skrue i vores clamps, en simpel unbrakonøgle. Det sikrer på den ene side, at samlingen holder og på den anden side, at man hurtigt og nemt kan foretage ændringer.

Muffe GALVANISERET



Varenr.	Str.	DKK
GK149-5	26,9	47,50
GK149-6	33,7	60,65
GK149-6-5	33,7x26,9	85,45
GK149-7	42,4	73,15
GK149-8	48,3	78,10
GK149-9	60,3	119,00

Vinkel 90° GALVANISERET



Varenr.	Str.	DKK
GK125-4	21,3	30,05
GK125-5	26,9	46,45
GK125-6	33,7	49,40
GK125-7	42,4	79,45
GK125-8	48,3	94,75
GK125-9	60,3	173,75

Leveringstid 3-6 dage for skaffevarer

Vinkel 40-70° GALVANISERET



Varenr.	Str.	DKK
GK123-8	48,3	197,00

Rørsamler GALVANISERET

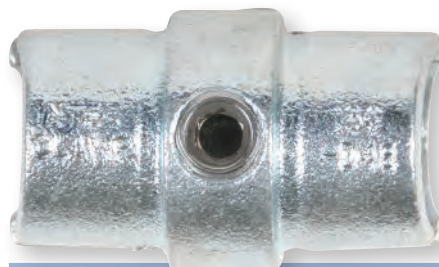

Varenr.	Str.	DKK
GK150-5	26,9	26,55
GK150-6	33,7	51,65
GK150-7	42,4	66,90
GK150-8	48,3	82,50

Vinkel 90° 0-11° GALVANISERET



Varenr.	Str.	DKK
GK154-6	33,7	95,30
GK154-7	42,4	97,45
GK154-8	48,3	98,25

Vinkel 15-60° GALVANISERET



Varenr.	Str.	DKK
GK124-6	33,7	75,90
GK124-7	42,4	113,75
GK124-8	48,3	115,50

Vinkel 90° 3-vejs
GALVANISERET



Varenr.	Str.	DKK
GK128-4	21,3	41,20
GK128-5	26,9	61,45
GK128-6	33,7	68,50
GK128-7	42,4	108,25
GK128-8	48,3	131,50
GK128-9	60,3	260,25

T-stk kort
GALVANISERET



Varenr.	Str.	DKK
GK101-4	21,3	24,60
GK101-5	26,9	36,35
GK101-6	33,7	41,20
GK101-7	42,4	63,05
GK101-7-6	42,4x33,7x42,4	66,10
GK101-7-8	42,4x48,3x42,4	78,35
GK101-8	48,3	72,90
GK101-8-7	48,3x42,4x48,3	72,90
GK101-9	60,3	132,25

T-stk vinklet 30-45°
GALVANISERET



Varenr.	Str.	DKK
GK127-6	33,7	87,95
GK127-7	42,4	136,50
GK127-8	48,3	178,50

Vinkel justerbar
GALVANISERET

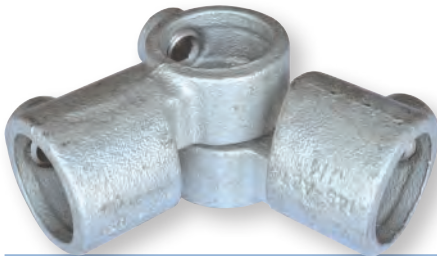

Varenr.	Str.	DKK
GK148-5	26,9	145,25
GK148-6	33,7	185,25
GK148-7	42,4	242,25
GK148-8	48,3	306,00

T-stk 0-11°
GALVANISERET



Varenr.	Str.	DKK
GK155-6	33,7	89,25
GK155-7	42,4	157,75
GK155-8	48,3	194,50

T-stk justerbar 30-60°
GALVANISERET



Varenr.	Str.	DKK
GK129-6	33,7	63,35
GK129-7	42,4	113,50
GK129-8	48,3	131,25

T-stk
GALVANISERET



Varenr.	Str.	DKK
GK104-5	26,9	62,30
GK104-6	33,7	67,45
GK104-7	42,4	107,75
GK104-8	48,3	127,50
GK104-9	60,3	242,00

T-stk kort 0-11°
GALVANISERET



Varenr.	Str.	DKK
GK153-6	33,7	95,30
GK153-7	42,4	97,45
GK153-8	48,3	98,25

T-stk m. sideudløb
GALVANISERET



Varenr.	Str.	DKK
GK176-4	21,3	47,25
GK176-5	26,9	59,80
GK176-6	33,7	86,80
GK176-7	42,4	126,50
GK176-8	48,3	135,00
GK176-9	60,3	254,25

T-stk svivel indsats
GALVANISERET



Varenr.	Str.	DKK
GK147-6	33,7	46,70
GK147-7	42,4	86,80
GK147-8	48,3	104,25

Hjørne
GALVANISERET



Varenr.	Str.	DKK
GK116-4	21,3	32,80
GK116-5	26,9	47,50
GK116-6	33,7	70,45
GK116-7	42,4	91,20
GK116-8	48,3	109,75
GK116-9	60,3	158,50

Kryds justerbar 30-45°
GALVANISERET



Varenr.	Str.	DKK
GK130-6	33,7	93,10
GK130-7	42,4	156,00
GK130-8	48,3	200,75

T-stk add-on
GALVANISERET



Varenr.	Str.	DKK
GK136-6	33,7	76,70
GK136-7	42,4	97,70
GK136-8	48,3	131,50

Kryds
GALVANISERET



Varenr.	Str.	DKK
GK119-4	21,3	35,25
GK119-5	26,9	48,35
GK119-6	33,7	70,45
GK119-7	42,4	106,25
GK119-8	48,3	110,75
GK119-9	60,3	200,75

Kryds m. gennemløb
GALVANISERET



Varenr.	Str.	DKK
GK158-4	21,3	60,05
GK158-5	26,9	89,85
GK158-6	33,7	119,00
GK158-7	42,4	185,00
GK158-8	48,3	220,00

T-stk klemme
GALVANISERET



Varenr.	Str.	DKK
GK135-5	26,9	47,80
GK135-6	33,7	56,25
GK135-7	42,4	74,00
GK135-8	48,3	75,30
GK135-9	60,3	124,25

Kryds 0-11°
GALVANISERET



Varenr.	Str.	DKK
GK156-6	33,7	74,00
GK156-7	42,4	128,50
GK156-8	48,3	148,50

Kryds overgang
GALVANISERET



Varenr.	Str.	DKK
GK137-6	33,7	80,80
GK137-7	42,4	103,00
GK137-8	48,3	131,50

Vægflange
GALVANISERET



Varenr.	Str.	DKK
GK131-4	21,3	34,90
GK131-5	26,9	50,80
GK131-6	33,7	60,05
GK131-7	42,4	75,90
GK131-8	48,3	114,50
GK131-9	60,3	172,75

Gelænderflange 0-11°
GALVANISERET



Varenr.	Str.	DKK
GK152-6	33,7	142,25
GK152-7	42,4	150,75
GK152-8	48,3	195,50

Hængsel hun
GALVANISERET



Varenr.	Str.	DKK
GK138-5	26,9	30,90
GK138-6	33,7	34,15
GK138-7	42,4	39,25
GK138-8	48,3	40,80

Vægflange
GALVANISERET

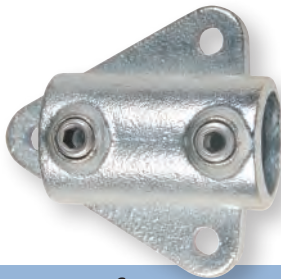

Varenr.	Str.	DKK
GK146-6	33,7	115,50
GK146-7	42,4	180,25
GK146-8	48,3	211,00

Gelænderbeslag
GALVANISERET



Varenr.	Str.	DKK
GK143-5	26,9	54,60
GK143-6	33,7	56,25
GK143-7	42,4	69,35
GK143-8	48,3	77,55

Hængsel han
GALVANISERET



Varenr.	Str.	DKK
GK140-5	26,9	42,40
GK140-6	33,7	45,85
GK140-7	42,4	50,80
GK140-8	48,3	52,95

Gelænderflange
GALVANISERET



Varenr.	Str.	DKK
GK132-5	26,9	86,80
GK132-6	33,7	116,50
GK132-7	42,4	150,75
GK132-8	48,3	164,75
GK132-9	60,3	268,25

Sokkelflange
GALVANISERET



Varenr.	Str.	DKK
GK134-6	33,7	372,25
GK134-7	42,4	496,75
GK134-8	48,3	513,75

Sidestøtte lodret
GALVANISERET



Varenr.	Str.	DKK
GK144-6	33,7	145,25
GK144-7	42,4	211,00
GK144-8	48,3	228,75

Sidestøtte vandret
GALVANISERET

Varenr.	Str.	DKK
GK145-6	33,7	150,50
GK145-7	42,4	197,00
GK145-8	48,3	227,00

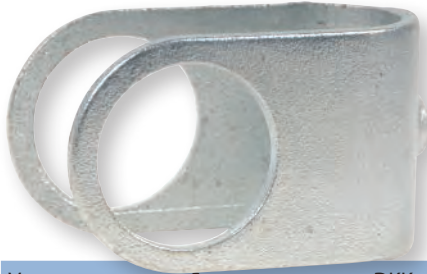
Bindeled klemme
GALVANISERET

Varenr.	Str.	DKK
GK160-6	33,7	43,65
GK160-7	42,4	65,30
GK160-8	48,3	86,30
GK160-9	60,3	101,00

Dobbelt svivellet 90°
GALVANISERET

Varenr.	Str.	DKK
GK168-5	26,9	116,50
GK168-6	33,7	146,75
GK168-7	42,4	183,00
GK168-8	48,3	215,25

Bindeled
GALVANISERET

Varenr.	Str.	DKK
GK161-5	26,9	43,95
GK161-6	33,7	47,50
GK161-7	42,4	70,45
GK161-7-6	42,4×33,7	70,45
GK161-8	48,3	73,15
GK161-8-6	48,3×33,7	72,40
GK161-8-7	48,3×42,4	84,40
GK161-9	60,3	147,75
GK161-9-8	60,3×48,3	116,25

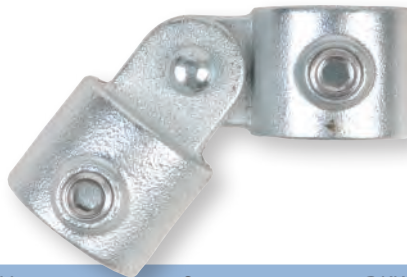
Enkelt svivellet
GALVANISERET

Varenr.	Str.	DKK
GK173-5	26,9	67,45
GK173-6	33,7	83,80
GK173-7	42,4	95,30
GK173-8	48,3	114,50
GK173-9	60,3	228,75

Drejbar flange
GALVANISERET

Varenr.	Str.	DKK
GK169-5	26,9	102,25
GK169-6	33,7	106,25
GK169-7	42,4	109,25
GK169-8	48,3	112,00
GK169-9	60,3	210,00

Bindeled m. muffe
GALVANISERET

Varenr.	Str.	DKK
GK165-5	26,9	50,25
GK165-6	33,7	71,00
GK165-7	42,4	113,00
GK165-8	48,3	136,50

Dobbelt svivellet
GALVANISERET

Varenr.	Str.	DKK
GK167-5	26,9	117,25
GK167-6	33,7	151,75
GK167-7	42,4	187,50
GK167-8	48,3	191,25

Beslag til gitter
GALVANISERET

Varenr.	Str.	DKK
GK170-5	26,9	19,05
GK170-6	33,7	18,30
GK170-7	42,4	22,15
GK170-8	48,3	23,75
GK170-9	60,3	26,20

Beslag dobb. til gitter

GALVANISERET

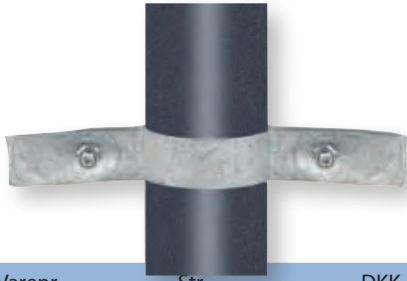

Varenr.	Str.	DKK
GK171-5	26,9	24,60
GK171-6	33,7	26,20
GK171-7	42,4	25,70
GK171-8	48,3	27,30
GK171-9	60,3	27,90

Låsekrave

GALVANISERET



Varenr.	Str.	DKK
GK179-5	26,9	15,10
GK179-6	33,7	20,20
GK179-7	42,4	24,20
GK179-9	48,3	25,70

Prop

PLAST



Varenr.	Str.	DKK
GK133-6	33,7	8,80
GK133-7	42,4	9,15
GK133-8	48,3	11,10
GK133-9	60,3	18,05

Enkeltsidet beslag

GALVANISERET



Varenr.	Str.	DKK
GK199-5	26,9	40,00
GK199-6	33,7	38,40
GK199-7	42,4	51,90
GK199-8	48,3	55,70

Krog

GALVANISERET



Varenr.	Str.	DKK
GK182-5	26,9	24,20
GK182-6	33,7	43,65
GK182-7	42,4	45,60
GK182-8	48,3	46,70

Dobbeltsidet beslag

GALVANISERET

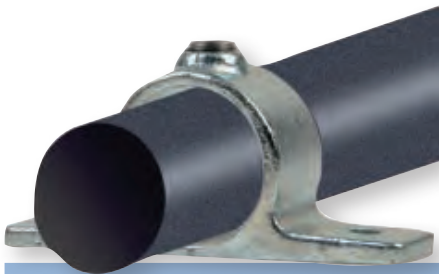

Varenr.	Str.	DKK
GK198-5	26,9	53,80
GK198-6	33,7	52,40
GK198-7	42,4	82,50
GK198-8	48,3	85,45

Metal prop

GALVANISERET



Varenr.	Str.	DKK
GK184-5	26,9	32,05
GK184-6	33,7	32,05
GK184-7	42,4	36,45
GK184-8	48,3	46,70
GK184-9	60,3	64,95

CLAMP TILBEHØR



Galvaniseret rør glat 2m

GALVANISERET

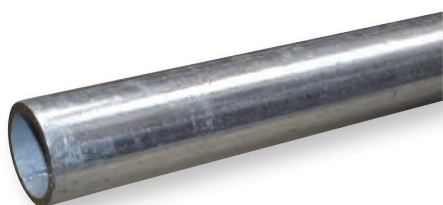

Varenr.	Str.	DKK
GK36-4	1/2"	84,10
GK36-5	3/4"	99,35
GK36-6	1"	141,50
GK36-7	1 1/4"	172,25
GK36-8	1 1/2"	195,00
GK36-9	2"	271,50

Unbrakonøgle



Varenr.	dim	Rør Ø	DKK
GK200-4	M5	21,3	10,40
GK200-5	1/4"	26,9-42,4	10,40
GK200-8	5/16"	48,3-60,3	15,85

Pinolskrue

AISI 201



Pinolskrue AISI 201 har ikke noget hoved, men en sekskant direkte i skrueløbet. Den monteres i gevindet på det ydre objekt, og strammes mod det indre objekts overflade, og forhindrer dermed de to objekters indbyrdes bevægelse.

En pinolskrue, også kendt som sætskrue, er en type skrue, der generelt anvendes til at fastgøre et objekt inden i et andet objekt, og har ofte gevind i hele sin længde. Pinolskrue bruges for at forhindre bevægelse mellem to roterende dele, så som et hjul på en aksel. Her skrues skruen i gevindet på hjulets nav, så spidsen strammer mod akslen. Samlingen er herved en friktionssamling mellem skrue og aksel.

Varenr.	dim	Rør Ø	DKK
GK203-4	1/8"×10	21,3	4,32
GK203-5	1/4"×12,5	26,9-42,4	5,95
GK203-8	3/8"×12,7	48,3-60,3	9,70

Reflekstape



Reflekstape med god bindingskraft, høj ydeevne og identifikation virkning. Tapen bruges primært i arbejdsområder, hvor der er behov for reflekterende afmærkning, så som i sikkerhedszoner og på gulve ved parkeringsarealer, kældre mv.

Varenr.	dim	Str.	DKK
GK204-1	red-white	5cm x 46m	125,75
GK204-2	black-yellow	5cm x 46m	125,75

FØDEVAREFITTINGS



62

PUSH-IN FITTINGS
RUSTFRI AISI 316



66

PUSH-ON FITTINGS
RUSTFRI AISI 316



67

PUSH-IN FITTINGS
MESSING FØDEVAREGODK.



68

SLANGER
TIL FØDEVARER



70

SVEJSEUNIONER
RUSTFRI TIL MEJERI



74

SVEJSEFITTINGS
RUSTFRI TIL MEJERI



76

SVEJSEFITTINGS
ISO RUSTFRI



78

SVEJSEFITTINGS
DIN RUSTFRI



80

PUSH-IN FITTINGS
POM



85

VENTILER
FØDEVAREGODKENDT

PUSH-IN FITTINGS RUSTFRI AISI 316



B serie: -0,99 til +15 bar
CP serie: -0,99 til +140 bar



B serie: -15°C til +225°C
CP serie: -110°C til +300°C



Rustfri syrefast push-in fittings i flot, ergonomisk design. Kan bruges til mange slags rør: PA, PE, PU samt PTFE. Alle cylindriske gevind kommer med VITON O-ringe, der sikrer nem og hurtig montering og gør dem særdeles velegnet til farmaceutisk-, kemi-, fødevarer- og medicinalindustri.

Fødevaregodkendt.

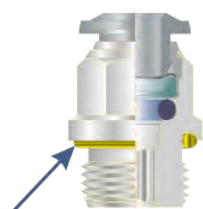

VITON® o-ring.



O-ringen mellem slange/rør og fittings sikrer total tætning også under udsatte installationer.

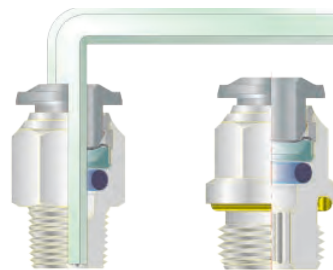

Alle lige fittings med gevind kan samles med en unbrakonøgle.

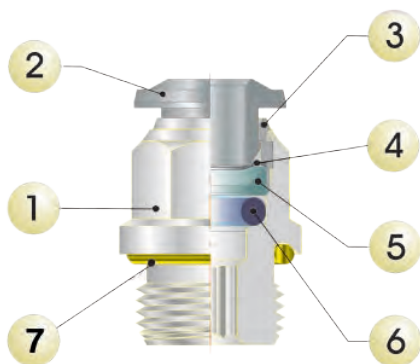

1. AISI 316L krop
2. AISI 316L krave
3. AISI 316L kraveholder
4. AISI 316L gribe ring
5. Teflon sikkerhedsring
6. VITON® o-ring
7. VITON® tætnings o-ring

Push-in har en ring med bagudrettede tænder, der griber ind i slangen og hindrer, at man kan trække slangen ud. Udløsserringen presser tænderne væk fra slangen, der så kan tages ud af fittingen.

Selve tætningen er en O-ring, placeret lige under de tænder, der fastholder slangen i fittingen. O-ringstype se teknisk beskrivelse.

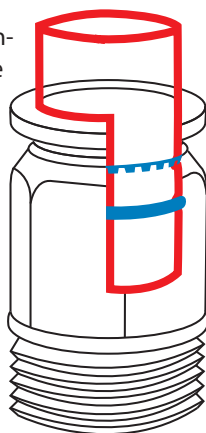

Nippel push-in AISI 316 - BSPT



Varenr.	ø × BSPT	DKK
B80-1	4 × 1/8"	173,25
B80-1-1	4 × 1/4"	193,00
B80-2	6 × 1/8"	206,50
B80-3	6 × 1/4"	216,75
B80-4	8 × 1/8"	227,75
B80-5	8 × 1/4"	233,25
B80-6	10 × 1/4"	302,25
B80-7	10 × 3/8"	239,25
B80-8	12 × 3/8"	477,50
B80-9	12 × 1/2"	531,00

Nippel push-in AISI 316 / VITON - BSPP



Varenr.	ø × BSPP	DKK
B81-1	4 × M5	239,00
B81-2	4 × 1/8"	235,50
B81-2-1	4 × 1/4"	237,75
B81-3	6 × 1/8"	235,50
B81-4	6 × 1/4"	263,75
B81-5	8 × 1/8"	261,50
B81-6	8 × 1/4"	296,75
B81-7	10 × 1/4"	324,00
B81-8	10 × 3/8"	392,00
B81-9	12 × 3/8"	493,25
B81-10	12 × 1/2"	546,75



Vores fødevarerprodukter opfylder kravene til direkte kontakt med fødevarer.

Fittings der hører til eliten!

Vinkel 90° push-in

AISI 316



Varenr.	ø	DKK
B82-1	4	335,50
B82-2	6	357,25
B82-3	8	413,25
B82-4	10	568,25
B82-5	12	790,00

Vinkel 90° push-in/nip svivel

AISI 316 - BSPT



Varenr.	ø × BSPT	DKK
B84-0	4 × 1/8"	440,75
B84-2	4 × 1/4"	481,75
B84-3	6 × 1/8"	444,00
B84-4	6 × 1/4"	510,50
B84-5	8 × 1/8"	520,75
B84-6	8 × 1/4"	529,75
B84-7	10 × 1/4"	699,25
B84-8	10 × 3/8"	715,00
B84-8-1	10 × 1/2"	740,25
B84-9	12 × 3/8"	914,25
B84-10	12 × 1/2"	940,50

Vinkel 90° push-in/nip svivel

AISI 316 / VITON - BSPP



Varenr.	ø × BSPP	DKK
B86-1	4 × M5	433,25
B86-2	4 × 1/8"	447,75
B86-2-1	4 × 1/4"	482,75
B86-3	6 × 1/8"	482,75
B86-4	6 × 1/4"	513,50
B86-5	8 × 1/8"	528,50
B86-6	8 × 1/4"	531,00
B86-8	10 × 1/4"	703,00
B86-9	10 × 3/8"	774,25
B86-10	10 × 1/2"	967,75
B86-11	12 × 3/8"	932,75
B86-12	12 × 1/2"	1186,75

T-stk push-in

AISI 316



Varenr.	ø	DKK
B94-1	4	471,25
B94-2	6	494,75
B94-3	8	572,00
B94-4	10	769,75
B94-5	12	956,25

T-stk push-in/nippel svivel

AISI 316 - BSPT



Varenr.	ø × BSPT × ø	DKK
B89K-1	4 × 1/8" × 4	463,00
B89K-2	4 × 1/4" × 4	586,25
B89K-3	6 × 1/8" × 6	588,75
B89K-4	6 × 1/4" × 6	626,00
B89K-5	8 × 1/8" × 8	651,75
B89K-6	8 × 1/4" × 8	660,75
B89K-7	10 × 1/4" × 10	902,25
B89K-8	10 × 3/8" × 10	916,25
B89K-9	10 × 1/2" × 10	942,50
B89K-10	12 × 3/8" × 12	1180,50
B89K-11	12 × 1/2" × 12	1205,25

T-stk push-in/nippel svivel

AISI 316 / VITON - BSPP



Varenr.	ø × BSPP × ø	DKK
B89C-1	4 × M5 × 4	528,50
B89C-2	4 × 1/8" × 4	513,50
B89C-3	4 × 1/4" × 4	588,75
B89C-4	6 × 1/8" × 6	621,75
B89C-5	6 × 1/4" × 6	626,00
B89C-6	8 × 1/8" × 8	658,50
B89C-7	8 × 1/4" × 8	662,25
B89C-8	10 × 1/4" × 10	906,75
B89C-9	10 × 3/8" × 10	977,50
B89C-10	10 × 1/2" × 10	1171,25
B89C-11	12 × 3/8" × 12	1197,00
B89C-12	12 × 1/2" × 12	1453,50

Union push-in

AISI 316



Varenr.	ø	DKK
B97-1	4	258,75
B97-2	6	262,75
B97-3	8	300,75
B97-4	10	407,25
B97-5	12	603,00

Skotgennemføring push-in

AISI 316



Varenr.	ø	Ext. dim	DKK
B98-1	4	M12*1	428,00
B98-2	6	M14*1	462,00
B98-3	8	M16*1	552,00
B98-4	10	M20*1	703,00
B98-5	12	M22*1	865,75

Brystnippel

AISI 316 - BSPT



Max 140 bar

Varenr.	BSPT	DKK
CP200-1	1/8"	109,50
CP200-2	1/4"	133,00
CP200-3	3/8"	145,50
CP200-4	1/2"	174,00
CP200-5	3/4"	199,50

Nippelmuffe

AISI 316 - BSPT×BSPP



Max 140 bar

Varenr.	BSPT × BSPP	DKK
CP203-2-1	1/4" × 1/8"	127,00
CP203-3-1	3/8" × 1/8"	138,75
CP203-3-2	3/8" × 1/4"	142,00
CP203-4-2	1/2" × 1/4"	169,25
CP203-4-3	1/2" × 3/8"	178,75
CP203-5-4	3/4" × 1/2"	215,25

Rørprop Unbrako

AISI 316 / VITON - BSPP



-15° til +225°C, 15bar

Varenr.	BSPP	DKK
CP206-1	1/8"	157,25
CP206-2	1/4"	175,50
CP206-3	3/8"	194,75
CP206-4	1/2"	195,75

Brystnippel reduktion

AISI 316 - BSPT



Max 140 bar

Varenr.	BSPT	DKK
CP201-1-2	1/4" × 1/8"	150,25
CP201-1-3	3/8" × 1/8"	163,75
CP201-2-3	3/8" × 1/4"	163,75
CP201-2-4	1/2" × 1/4"	187,50
CP201-3-4	1/2" × 3/8"	188,50
CP201-4-5	3/4" × 1/2"	253,25

Muffe

AISI 316 - BSPP



Max 140 bar

Varenr.	BSPP	DKK
CP204-1	1/8"	61,70
CP204-2	1/4"	87,35
CP204-3	3/8"	124,00
CP204-4	1/2"	200,50
CP204-5	3/4"	300,00

Rørprop sekskant

AISI 316 - BSPT

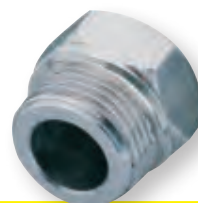

Max 140 bar

Varenr.	BSPT	DKK
CP207-1	1/8"	118,00
CP207-2	1/4"	129,25
CP207-3	3/8"	142,00
CP207-4	1/2"	176,50
CP207-5	3/4"	220,00

Spidsmuffe

AISI 316 - BSPP×BSPT



Max 140 bar

Varenr.	BSPP × BSPT	DKK
CP202-1-2	1/4" × 1/8"	140,00
CP202-2-3	3/8" × 1/4"	171,50
CP202-2-4	1/2" × 1/4"	211,00
CP202-3-4	1/2" × 3/8"	215,25
CP202-4-5	3/4" × 1/2"	275,00

Formmuffe

AISI 316 - BSPP



Max 140 bar

Varenr.	BSPP	DKK
CP205-1-2	1/4" × 1/8"	82,75
CP205-2-3	3/8" × 1/4"	122,25
CP205-3-4	1/2" × 3/8"	152,50
CP205-4-5	3/4" × 1/2"	255,25

Rørprop Unbrako

AISI 316 - BSPT



Max 140 bar

Varenr.	BSPT	DKK
CP208-1	1/8"	100,25
CP208-2	1/4"	108,50
CP208-3	3/8"	121,50
CP208-4	1/2"	153,50

Slangenippel

AISI 316 - BSPT



Max 140 bar

Varenr.	Ø × BSPT	DKK
CP209-1	6 × 1/8"	72,90
CP209-2	7 × 1/8"	72,90
CP209-3	7 × 1/4"	88,75
CP209-4	8 × 1/4"	88,75
CP209-5	9 × 1/4"	88,75
CP209-6	9 × 3/8"	115,00
CP209-7	10 × 1/4"	88,75
CP209-8	10 × 3/8"	115,00
CP209-9	10 × 1/2"	172,75
CP209-10	12 × 1/4"	88,75
CP209-11	12 × 3/8"	115,00
CP209-12	12 × 1/2"	172,75
CP209-13	14 × 3/8"	113,50
CP209-14	14 × 1/2"	172,75
CP209-15	16 × 1/2"	172,75
CP209-16	18 × 1/2"	172,75
CP209-17	18 × 3/4"	246,50
CP209-18	20 × 1/2"	172,75
CP209-19	20 × 3/4"	246,50

Slangenippel

AISI 316 / VITON - BSPP



Varenr.	Ø × BSPP	DKK
B105-10	10 × 1/4"	125,75
B105-11	10 × 3/8"	171,00
B105-12	12 × 3/8"	182,00
B105-13	12 × 1/2"	270,00

Vinkel 90° muffe

AISI 316 - BSPP



Max 140 bar

Varenr.	BSPP	DKK
CP213-1	1/8"	243,00
CP213-2	1/4"	332,00
CP213-3	3/8"	415,75
CP213-4	1/2"	510,00

Vinkel 90° muffe/nippel

AISI 316 - BSPP × BSPT



Max 140 bar

Varenr.	BSPP × BSPT	DKK
CP214-1	1/8"	243,00
CP214-2	1/4"	332,00
CP214-3	3/8"	415,75
CP214-4	1/2"	510,00

T-stk muffe

AISI 316 - BSPP



Max 140 bar

Varenr.	BSPP	DKK
CP210-1	1/8"	301,25
CP210-2	1/4"	422,75
CP210-3	3/8"	546,50
CP210-4	1/2"	674,00

T-stk muffe/nippel/muffe

AISI 316 - BSPP × BSPT



Max 140 bar

Varenr.	BSPP × BSPT × BSPP	DKK
CP211-1	1/8"	301,25
CP211-2	1/4"	422,75
CP211-3	3/8"	546,50
CP211-4	1/2"	674,00

T-stk muffe/muffe/nippel

AISI 316 - BSPT × BSPP



Max 140 bar

Varenr.	BSPT × BSPP × BSPP	DKK
CP212-1	1/8"	301,25
CP212-2	1/4"	422,75
CP212-3	3/8"	546,50
CP212-4	1/2"	674,00

PUSH-ON FITTINGS RUSTFRI AISI 316



-0,99bar til max 15bar



-15°C til +200°C



Push-on fittings er særdeles velegnet til luft og væsker til max 20 bar.

Fødevaregodkendt.



Vores fødevareprodukter opfylder kravene til direkte kontakt med fødevarer.

Fittings der hører til eliten!

Nippel push-on

AISI 316 / VITON - BSPP



Varenr.	Ø/ø × BSPP	L	DKK
BE51-1	6/4 × 1/8"	23	164,00
BE51-2	6/4 × 1/4"	25,5	186,50
BE51-3	8/6 × 1/8"	23	167,00
BE51-4	8/6 × 1/4"	25,5	190,25
BE51-6	10/8 × 1/4"	27,5	203,00
BE51-7	10/8 × 3/8"	29	216,00

Union push-on

AISI 316



Varenr.	Ø/ø	L	DKK
BE54-3	6/4	29,5	274,25
BE54-4	8/6	30	282,75
BE54-5	10/8	34,5	319,50

Skotgennemføring push-on

AISI 316



Varenr.	Ø/ø	Ext. dim	L	DKK
BE55-3	6/4	M10*1	44	393,75
BE55-4	8/6	M12*1	44	431,50

Vinkel 90° push-on/nippel

AISI 316 - BSPT



Varenr.	Ø/ø × BSPT	L1 × L2	DKK
BE56-1	6/4 × 1/8"	21 × 15,5	322,75
BE56-2	6/4 × 1/4"	21 × 19,5	327,00
BE56-3	8/6 × 1/8"	22,5 × 17	333,50
BE56-4	8/6 × 1/4"	22,5 × 21	338,00
BE56-7	10/8 × 1/4"	25,5 × 21,5	381,00
BE56-8	10/8 × 3/8"	25,5 × 22	385,00

Vinkel 90° push-on

AISI 316

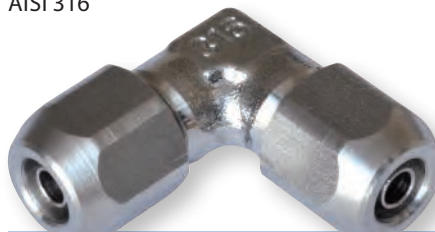

Varenr.	Ø/ø	L	DKK
BE58-1	6/4	21	403,00
BE58-2	8/6	22,5	415,75
BE58-3	10/8	25,5	476,25

T-stk push-on/nippel gren

AISI 316 - BSPT



Varenr.	Ø/ø × BSPT	L1 × L2	DKK
BE60-1	6/4 × 1/8"	42 × 15,5	527,75
BE60-2	6/4 × 1/4"	42 × 19,5	534,75
BE60-3	8/6 × 1/8"	45 × 17	552,00
BE60-4	8/6 × 1/4"	45 × 21	556,25
BE60-6	10/8 × 1/4"	51 × 21,5	598,00
BE60-7	10/8 × 3/8"	51 × 22	602,50

T-stk push-on

AISI 316



Varenr.	Ø/ø	L1 × L2	DKK
BE59-1	6/4	42 × 21	604,50
BE59-2	8/6	45 × 22,5	633,00
BE59-3	10/8	51 × 25,5	691,00

Omløber push-on

AISI 316



Varenr.	Ø/ø	Ext. dim	L	DKK
BE71-1	6/4	M10*1	11	76,70
BE71-2	8/6	M12*1	11,5	81,40
BE71-3	10/8	M14*1	13,5	93,40

PUSH-IN FITTINGS MESSING FØDEVAREGODKENDT



-0,99 bar til +20 bar



-15°C til +200°C



Iht. NSF/ANSI-61: NSF-51

Denne serie i push-in fittings af forniklet messing er fødevareregodkendt.



Vores fødevarerprodukter opfylder kravene til direkte kontakt med fødevarer.

Fittings der hører til eliten!

Union push-in MESSING



Varenr.	ø	DKK
EF97-1	4	73,45
EF97-2	6	80,00
EF97-3	8	91,20
EF97-4	10	114,50
EF97-5	12	137,75

T-stk push-in MESSING



Varenr.	ø	DKK
EF94-1	4	110,75
EF94-2	6	124,50
EF94-3	8	142,50
EF94-4	10	185,25
EF94-5	12	230,50

Nippel push-in MESSING / VITON - BSPP



Varenr.	ø × BSPP	DKK
EF81-1	4 × M5	46,20
EF81-2	4 × 1/8"	45,85
EF81-3	6 × 1/8"	48,40
EF81-4	6 × 1/4"	52,20
EF81-5	8 × 1/8"	53,50
EF81-6	8 × 1/4"	57,60
EF81-7	10 × 1/4"	71,55
EF81-8	10 × 3/8"	76,70
EF81-9	12 × 3/8"	91,50

Vinkel 90° push-in/nippel MESSING / VITON - BSPP



Varenr.	ø × BSPP	DKK
EF84-1	4 × M5	69,90
EF84-2	4 × 1/8"	74,00
EF84-3	6 × 1/8"	77,55
EF84-4	6 × 1/4"	83,00
EF84-5	8 × 1/8"	87,10
EF84-6	8 × 1/4"	91,75
EF84-7	10 × 1/4"	115,25
EF84-8	10 × 3/8"	128,25
EF84-9	12 × 3/8"	149,75

T-stk push-in/nippel gren MESSING / VITON - BSPP



Varenr.	ø × BSPP × ø	DKK
EF89-1	4 × 1/8" × 4	102,50
EF89-2	6 × 1/8" × 6	107,50
EF89-3	6 × 1/4" × 6	114,25
EF89-4	8 × 1/8" × 8	128,00
EF89-5	8 × 1/4" × 8	133,25

SLANGER TIL FØDEVARER



Herunder findes de af vores slanger, der er fødevaregodkendte.

For det første Alfafood og Alfasteam, 2 specialslanger til fødevarer industrien, fremstillet specielt med henblik på dette marked. Men også vores teflonslange og Filclair PVC slanger.

FØDEVARE FITTINGS

Alfafood slange 40m

NBR / PVC / SBR



Indvendig NBR i fødevarer kvalitet, forstærkende tekstilmellelag, udvendig blå NBR/PVC/SBR.

-30° til +85°C. Max 10 bar.

Varenr.	ø/Ø	BAR	L	DKK / m
JA40-13	13/21	10	40m	208,00
JA40-19	19/28	10	40m	261,00

JA40-25 25/36 10 40m 335,50
Denne slange kan leveres i afkortede længder op til max 5 meter. Afkortningsgebyr D.kr. 75,00.

Alfasteam slange 40m

EPDM



Indvendig EPDM i fødevarer kvalitet, forstærkende tekstilmellelag, udvendig blå EPDM/CSM.

-30° til +165°C. Max 6 bar

Varenr.	ø/Ø	BAR	L	DKK / m
JA41-12	12,7/23	6	40m	175,50
JA41-19	19/30	6	40m	229,25
JA41-25	25/38	6	40m	303,75
JA41-32	32/46	6	40m	398,00
JA41-38	38/54	6	40m	501,25

Afskæres mellem 1 - 5m, ellers 40m.

Filclair N slange neutral

PVC (POLYVINYLCHLORID)



-15° til +60°C

Varenr.	ø/Ø	bar 20°C	L	DKK
J70200804	4/8	10	50m	488,50
J70201206	6/12	15	50m	663,00
J70201408	8/14	15	50m	719,00
J70201610	10/16	15	50m	808,25
J70201913	13/19	10	50m	1005,25
J70202216	16/22	10	50m	1278,25
J70202619	19/26	10	50m	1709,00
J70203325	25/33	10	50m	2160,00
J70204232	32/42	12	50m	4080,00
J70204838	38/48	10	50m	4596,00
J70206050	50/60	8	50m	5074,00

Sælges kun i fuld længde.

Filclair AL slange blå

PVC (POLYVINYLCHLORID)

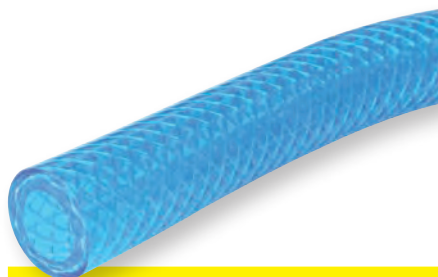

-15° til +60°C

Varenr.	ø/Ø	bar 20°C	L	DKK
J70241206	6/12	15	50m	663,00
J70241408	8/14	15	50m	719,00
J70241610	10/16	15	50m	808,25
J70241913	13/19	10	50m	1068,25

Sælges kun i fuld længde.

Filclair AL slange rød

PVC (POLYVINYLCHLORID)



-15° til +60°C

Varenr.	ø/Ø	bar 20°C	L	DKK
J70231206	6/12	15	50m	663,00
J70231408	8/14	15	50m	719,00
J70231610	10/16	15	50m	808,25
J70231913	13/19	10	50m	1068,25

Sælges kun i fuld længde.

Teflonslange 50m

PTFE (TEFLON)

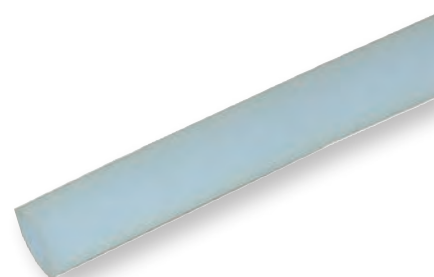

Lav friktion, egnet til næsten alle kemikalier og opløsningsmidler. Elektrisk isolerende og vejrbestandig, ideel til rustfri push-in og kompres.fittings.

-150° til +210°C

Varenr.	Ø/ø	BAR	L	DKK / m
J50000402	4/2	95	50m	87,35
J50000604	6/4	80	50m	95,90
J50000806	8/6	56	50m	122,25
J50001008	10/8	42	50m	152,75
J50001210	12/10	34	50m	216,75

Afskæres mellem 1 - 5m, ellers 50m.

Cristal slange

PVC (POLYVINYLCHLORID)



Klar PVC slange, uforstærket, brugbar til utallige trykløse formål.

-15° til +60°C

Varenr.	ø/Ø	bar 20°C	L	DKK
JA3-0204-100	2/4	0	100m	407,50
JA3-0305-100	3/5	0	100m	465,75
JA3-0406-100	4/6	0	100m	477,50
JA3-0608-50	6/8	0	50m	273,75
JA3-0608-100	6/8	0	100m	547,25
JA3-0609-100	6/9	0	100m	606,00
JA3-0810	8/10	0	50m	409,75
JA3-0812	8/12	0	50m	737,75
JA3-1013	10/13	0	50m	545,00
JA3-1216	12/16	0	50m	833,50
JA3-1620	16/20	0	50m	1087,75
JA3-1924	19/24	0	50m	1343,25
JA3-2531	25/31	0	50m	2402,00
JA3-3240	32/40	0	25m	2174,50
JA3-3848	38/48	0	25m	3025,25
JA3-5060	50/60	0	25m	4720,50
JA3-6070	60/70	0	25m	5565,25

Sælges kun i fuld længde.

SVEJSEUNIONER RUSTFRI TIL MEJERI



Kan leveres med
3.1 certifikat

DS, SMS og DIN unioner samt ISO clamps.

Ved denne form for fittings, er dele, der kommer i forbindelse med mediet, lavet af AISI 316. Dele, der ikke "rører" mediet, er lavet af AISI 304.

Fødevaregodkendt.

DS svejseunion AISI 316



Omløber = AISI 304

Varenr.	dim	DKK
BP1-6	25	250,50
BP1-8	38	307,25
BP1-9	51	378,75
BP1-10	63,5	499,00
BP1-11	76,1	601,50
BP1-12	101,6	1397,75

DS omløber AISI 304



Varenr.	dim	ØD	DKK
BP1-6B	25	57	74,30
BP1-8B	38	71	78,65
BP1-9B	51	86	101,75
BP1-10B	63,5	103	130,00
BP1-11B	76,1	115	151,75
BP1-12B	101,6	150	529,25

DS svejsekrave AISI 316



Varenr.	dim	DKK
BP1-6D	25	74,30
BP1-8D	38	104,00
BP1-9D	51	123,00
BP1-10D	63,5	141,50
BP1-11D	76,1	185,25
BP1-12D	101,6	298,50

DS svejsenippel AISI 316



Varenr.	dim	DKK
BP1-6A	25	102,75
BP1-8A	38	123,00
BP1-9A	51	147,50
BP1-10A	63,5	220,75
BP1-11A	76,1	258,25
BP1-12A	101,6	544,00

DS pakning NBR



Varenr.	dim	DKK
BP1-6C	25	7,25
BP1-8C	38	8,05
BP1-9C	51	8,05
BP1-10C	63,5	8,05
BP1-11C	76,1	8,05
BP1-12C	101,6	21,45

DS blændskive AISI 316



Varenr.	dim	ØD	DKK
BP1-6E	25	40	68,50
BP1-8E	38	54	74,30
BP1-9E	51	68	93,40
BP1-10E	63,5	84	117,50
BP1-11E	76,1	96	128,25
BP1-12E	101,6	124	192,50



Vores fødevareprodukter opfylder kravene til direkte kontakt med fødevarer.

Fittings der hører til eliten!

SMS svejseunion AISI 316



Omløber = AISI 304

Varenr.	dim	DKK
BP30-6	25	372,50
BP30-7	32	417,50
BP30-8	38	454,00
BP30-9	51	513,25
BP30-10	63,5	725,00
BP30-11	76,1	890,25
BP30-12	101,6	1968,50

SMS pakning NBR



Varenr.	dim	DKK
BP30-6C	25	4,78
BP30-7C	32	7,70
BP30-8C	38	6,80
BP30-9C	51	7,65
BP30-10C	63,5	6,15
BP30-11C	76,1	7,70
BP30-12C	101,6	32,70

SMS svejsenippel AISI 316



Varenr.	dim	DKK
BP30-6A	25	149,25
BP30-7A	32	167,50
BP30-8A	38	182,50
BP30-9A	51	201,50
BP30-10A	63,5	281,75
BP30-11A	76,1	332,50
BP30-12A	101,6	576,75

SMS svejsekrave AISI 316



Varenr.	dim	DKK
BP30-6D	25	96,40
BP30-7D	32	111,00
BP30-8D	38	122,00
BP30-9D	51	140,25
BP30-10D	63,5	191,00
BP30-11D	76,1	242,00
BP30-12D	101,6	336,50

SMS omløber AISI 304



Varenr.	dim	ØD	DKK
BP30-6B	25	51	124,00
BP30-7B	32	60	131,75
BP30-8B	38	74	152,50
BP30-9B	51	84	176,50
BP30-10B	63,5	100	240,00
BP30-11B	76,1	114	310,50
BP30-12B	101,6	154	807,75

SMS blændskive AISI 316



Varenr.	dim	ØD	DKK
BP30-6E	25	39,5	93,10
BP30-7E	32		110,25
BP30-8E	38	55	124,00
BP30-9E	51	65	141,50
BP30-10E	63,5	80	183,50
BP30-11E	76,1	93	246,50
BP30-12E	101,6	127	368,75

DIN svejseunion

AISI 316



Omløber = AISI 304

Varenr.	DN	L	DKK
BP32-3	10	25mm	378,50
BP32-4	15	25mm	408,75
BP32-5	20	25mm	545,25
BP32-6	25	31mm	467,50
BP32-7	32	31mm	475,75
BP32-8	40	31mm	492,25
BP32-9	50	33mm	572,75
BP32-10	65	35mm	815,00
BP32-11	80	35mm	1592,50
BP32-12	100	41mm	2027,25

DIN omløber

AISI 304



Varenr.	DN	ØD	DKK
BP32-3B	10	38	89,85
BP32-4B	15	44	155,75
BP32-5B	20	54	155,75
BP32-6B	25	63	155,75
BP32-7B	32	70	155,75
BP32-8B	40	78	159,75
BP32-9B	50	92	186,25
BP32-10B	65	112	292,25
BP32-11B	80	127	457,00
BP32-12B	100	148	630,25

DIN svejsekrave

AISI 316



Varenr.	DN	DKK
BP32-3D	10	83,55
BP32-4D	15	89,85
BP32-5D	20	162,25
BP32-6D	25	162,25
BP32-7D	32	162,25
BP32-8D	40	162,25
BP32-9D	50	160,50
BP32-10D	65	207,50
BP32-11D	80	351,25
BP32-12D	100	618,75

DIN svejsenippel

AISI 316



Varenr.	DN	DKK
BP32-3A	10	193,50
BP32-4A	15	164,25
BP32-5A	20	164,25
BP32-6A	25	164,25
BP32-7A	32	176,50
BP32-8A	40	186,25
BP32-9A	50	218,25
BP32-10A	65	297,25
BP32-11A	80	497,00
BP32-12A	100	756,25

DIN pakning

NBR



Varenr.	DN	DKK
BP32-3C	10	6,80
BP32-4C	15	6,80
BP32-5C	20	6,80
BP32-6C	25	6,80
BP32-7C	32	6,80
BP32-8C	40	8,90
BP32-9C	50	8,90
BP32-10C	65	17,90
BP32-11C	80	17,90
BP32-12C	100	17,90

Hagenøgle

GALVANISERET



For ISO/DIN unioner

Varenr.	dim	DKK
BP0-2	ISO 25-76 / DIN 20-65	555,25

ISO svejseclamp

AISI 316



Clamp = AISI 304

Varenr.	Ø	DKK
BP2-4	12,7	518,75
BP2-5	19	518,75
BP2-6	25	598,00
BP2-8	38	602,50
BP2-9	51	717,00
BP2-10	63,5	800,50
BP2-11	76,1	969,00
BP2-12	101,6	1443,25

ISO clamp

AISI 304



Varenr.	Ø	ØD	DKK
BP2-4B	12,7		309,50
BP2-5B	19		309,50
BP2-6B	25	63,8	317,50
BP2-9B	51	77,4	387,50
BP2-10B	63,5	90,4	397,25
BP2-11B	76,1	103,6	467,50
BP2-12B	101,6	132,6	520,00

ISO svejseferrule

AISI 316



Varenr.	Ø	DKK
BP2-4A	12,7	129,50
BP2-5A	19	129,50
BP2-6A	25	133,00
BP2-8A	38	135,25
BP2-9A	51	153,50
BP2-10A	63,5	190,25
BP2-11A	76,1	239,50
BP2-12A	101,6	440,00

ISO clamp pakning

NBR



Varenr.	Ø	ØD	DKK
BP2-4C	12,7		15,60
BP2-5C	19		15,60
BP2-6C	25	52,7	15,60
BP2-8C	38	52,7	15,60
BP2-9C	51	66,2	23,45
BP2-10C	63,5	79,7	23,45
BP2-11C	76,1	93,2	23,45
BP2-12C	101,6	121,2	44,45

ISO clamp blændskive

AISI 316

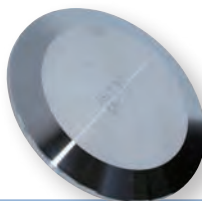

Varenr.	Ø	ØD	DKK
BP2-4E	12,7		118,00
BP2-5E	19		118,00
BP2-6E	25	50,4	124,00
BP2-8E	38	50,4	135,75
BP2-9E	51	63,9	141,50
BP2-10E	63,5	77,4	183,50
BP2-11E	76,1	90,9	294,00
BP2-12E	101,6	118,9	282,75

SVEJSEFITTINGS RUSTFRI TIL MEJERI



Kan leveres med
3.1 certifikat

DS, SMS og DIN unioner samt ISO clamps.

Ved denne form for fittings, er dele, der kommer i forbindelse med mediet, lavet af AISI 316. Dele, der ikke "rører" mediet, er lavet af AISI 304.

Fødevaregodkendt.



Vores fødevareprodukter opfylder kravene til direkte kontakt med fødevarer.

Fittings der hører til eliten!

Butterflyventil

AISI 316



Uden håndtag

Varenr.	dim	DKK
BP33-6	25	2110,50
BP33-8	38	2136,25
BP33-9	51	2305,25
BP33-10	63,5	2770,75
BP33-11	76,1	3613,25
BP33-12	101,6	4517,75

Håndtag

AISI 316



Varenr.	dim	DKK
BP33-8-H	25-63,5	501,75
BP33-11-H	76,1	832,50
BP33-12-H	101,6	832,50

Pakningsæt

EPDM



Varenr.	dim	DKK
BP33-6A	25	349,75
BP33-8A	38	362,75
BP33-9A	51	392,00
BP33-10A	63,5	374,25
BP33-11A	76,1	574,25
BP33-12A	101,6	1002,00



Aktuator til BP33

AISI 304



Varenr.	dim	DKK
BP33-6B	25	7173,00
BP33-8B	38	7196,75
BP33-9B	51	7367,75
BP33-10B	63,5	7844,50
BP33-11B	76,1	8528,50
BP33-12B	101,6	9424,50

Inkl. bolte

Kontraventil

AISI 316



Varenr.	dim	DKK
BP70-6	25	4663,00
BP70-8	38	5110,00
BP70-9	51	5966,00
BP70-10	63,5	7844,50
BP70-11	76,1	9883,00
BP70-12	101,6	19086,00

Tankrenser roterende

AISI 316 - BSPP



Ø3/4" L=102mm

Varenr.	m ³ /h	Output	DKK
BP73-5	5,5	360°	6489,00

Rense- tankdæksel

AISI 316



Dim = LxBxH

Varenr.	dim	DKK
BP41-1	440 x 320 x 60	5046,00

Grov filter

AISI 316



Tankrenser roterende

AISI 316



Clip-on Ø17,4 L=62mm

Varenr.	m ³ /h	Output	DKK
BP74-1	2,9	360°	8538,75
BP74-2	1,8	360° low flow	8538,75
BP74-3	2,8	270°	8538,75
BP74-4	1,8	270° low flow	8538,75

Rense- tankdæksel

AISI 316



Dim = ØxH

Varenr.	dim	DKK
BP42-1	454 x 100	6083,25
BP42-2	520 x 100	7950,75

Grov filter

AISI 316



Rense- tankdæksel

AISI 316



Dim = LxBxH

Varenr.	dim	DKK
BP40-1	234 x 184 x 40	3307,50

Grov filter

AISI 316



Inkl. filterindsats m. 1mm huller

Varenr.	dim	- -	H	DKK
BP80-6	25	1,2	419mm	11057,25
BP80-7	38	1,2	375mm	11057,25
BP80-8	51	1,1	333mm	11325,00
BP80-9	63,5	1,6	467mm	16511,00
BP80-10	76,1	2	428mm	23669,50

Inkl. filterindsats m. 3mm huller

Varenr.	dim	- -	H	DKK
BP82-6	25	1,2	419mm	11057,25
BP82-7	38	1,2	375mm	11057,25
BP82-8	51	1,1	333mm	11325,00
BP82-9	63,5	1,6	467mm	16511,00
BP82-10	76,1	2	428mm	23669,50



SVEJSEFITTINGS ISO RUSTFRI



Kan leveres med
3.1 certifikat

ISO rustfri AISI 316 bøjninger, reduktioner
og T-stykker.

Fødevaregodkendt.



Vores fødevareprodukter
opfylder kravene til direkte
kontakt med fødevarer.

Fittings der hører til eliten!

ISO svejsebøjning 90° 1D

AISI 316

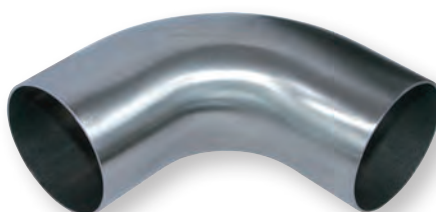

Varenr.	dim	- -	DKK
BP3-6	25	1,2	144,50
BP3-8	38	1,2	174,00
BP3-9	51	1,2	214,00
BP3-10	63,5	1,6	279,50
BP3-11	76,1	2	488,25

α = spørg på pris

ISO svejsebøjning 90° 1,5D

AISI 316



Varenr.	dim	- -	DKK
BP5-6	25	1,2	149,75
BP5-8	38	1,2	184,75
BP5-9	51	1,2	215,75
BP5-10	63,5	1,6	289,75
BP5-11	76,1	1,6	517,75
BP5-12	101,6	2	926,00

ISO svejsebøjning 45° 1D

AISI 316

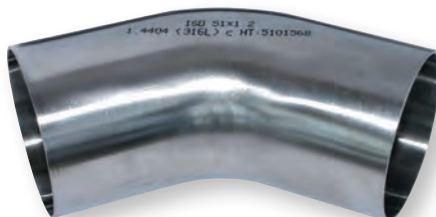

Varenr.	dim	- -	DKK
BP4-6	25	1,2	172,75
BP4-8	38	1,2	233,75
BP4-9	51	1,2	238,25
BP4-10	63,5	1,6	322,00
BP4-11	76,1	2	425,25
BP4-12	101,6	2	790,75

ISO svejsereduktion

AISI 316

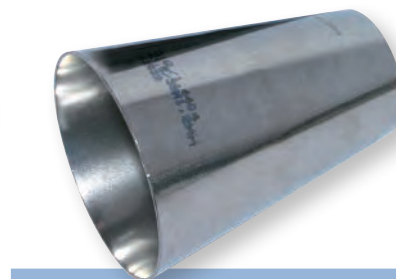

Varenr.	dim	- -	DKK
BP8-1	38 × 25	1,2	196,75
BP8-2	51 × 25	1,2	329,50
BP8-3	51 × 38	1,2	209,00
BP8-4	63 × 25	1,6 × 1,2	741,25
BP8-5	63 × 38	1,6 × 1,2	275,00
BP8-6	63 × 51	1,6 × 1,2	209,00
BP8-7	76 × 25	1,6 × 1,2	1149,50
BP8-8	76 × 38	1,6 × 1,2	350,25
BP8-9	76 × 51	1,6 × 1,2	311,50
BP8-10	76 × 63	1,6 × 1,6	247,50
BP8-11	102 × 38	2 × 1,2	1062,00
BP8-12	102 × 51	2 × 1,2	437,50
BP8-13	102 × 63	2 × 1,6	365,00
BP8-14	102 × 76	2 × 1,6	341,25

ISO svejse T-stk

AISI 316



Varenr.	Ø	- -	DKK
BP9-6	25	1,2	233,75
BP9-8	38	1,2	262,75
BP9-9	51	1,2	299,00
BP9-10	63,5	1,6	376,00
BP9-11	76,1	2	447,75
BP9-12	101,6	2	838,25

ISO svejse T-stk red.

AISI 316



Varenr.	Ø	- -	DKK
BP9-20	38 × 25 × 38	1,2	228,75
BP9-21	51 × 25 × 38	1,2	265,75
BP9-22	51 × 38 × 51	1,2	271,75
BP9-23	63,5 × 25 × 63,5	1,6	339,25
BP9-24	63,5 × 38 × 63,5	1,6	339,25
BP9-25	63,5 × 51 × 63,5	1,6	412,50
BP9-26	76,1 × 25 × 76,1	2	611,50
BP9-27	76,1 × 38 × 76,1	2	418,50
BP9-28	76,1 × 51 × 76,1	2	511,25
BP9-29	76,1 × 63,5 × 76,1	2	418,50
BP9-30	101,6 × 25 × 101,6	2	969,50
BP9-31	101,6 × 38 × 101,6	2	768,75
BP9-32	101,6 × 51 × 101,6	2	843,25
BP9-33	101,6 × 63,5 × 101,6	2	758,00
BP9-34	101,6 × 76,1 × 101,6	2	1115,50
BP9-35	104 × 25 × 104	2	518,25
BP9-36	104 × 38 × 104	2	518,25
BP9-37	104 × 51 × 104	2	518,25
BP9-38	104 × 63,5 × 104	2	518,25
BP9-39	104 × 76,1 × 104	2	518,25

Rørholder, stram

AISI 304



Til påsvejsning

Varenr.	Ø	Skaft Ø	DKK
BP12-4	13,5	8	128,00
BP12-6	25,4	21,3	109,25
BP12-8	38,1	21,3	112,00
BP12-9	51,0	21,3	119,75
BP12-10	63,5	21,3	133,50
BP12-11	76,2	21,3	139,25
BP12-12	101,6	21,3	152,00

Rørholder, løs

AISI 304



Til påsvejsning

Varenr.	Ø	Skaft Ø	DKK
BP12-6L	27,0	21,3	109,25
BP12-8L	40,0	21,3	112,00
BP12-9L	53,0	21,3	119,75
BP12-10L	65,5	21,3	133,50
BP12-11L	78,0	21,3	139,25
BP12-12L	104,0	21,3	152,00

SVEJSEFITTINGS DIN RUSTFRI



Kan leveres med
3.1 certifikat

DIN rustfri AISI 316 bøjninger, reduktioner
og T-stykker.

Fødevaregodkendt.



Vores fødevareprodukter
opfylder kravene til direkte
kontakt med fødevarer.

Fittings der hører til eliten!

DIN svejsebøjning 90° 1D AISI 316



Varenr.	DN	- -	DKK
BP61-3	10	1,5	214,25
BP61-4	15	1,5	214,25
BP61-5	20	1,5	214,25
BP61-6	25	1,5	201,50
BP61-7	32	1,5	227,00
BP61-8	40	1,5	228,00
BP61-9	50	1,5	301,75
BP61-10	65	2	433,75
BP61-11	80	2	751,50
BP61-12	100	2	982,00
BP61-13	125	2	2367,00
BP61-14	150	2	2988,25

DIN svejsebøjning 45° 1D AISI 316

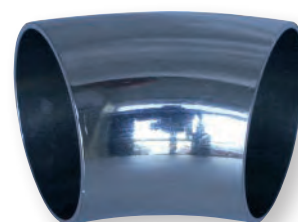

Varenr.	DN	- -	DKK
BP62-6	25	1,5	352,25
BP62-7	32	1,5	387,00
BP62-8	40	1,5	444,00
BP62-9	50	1,5	533,50
BP62-10	65	2	655,00
BP62-11	80	2	1115,50
BP62-12	100	2	1624,50
BP62-13	125	2	3059,25
BP62-14	150	2	4496,00

DIN svejsereduktion

AISI 316

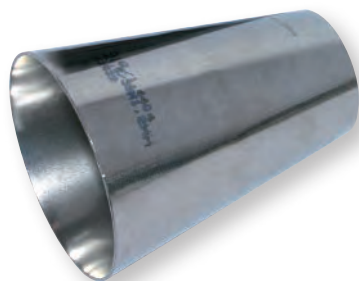

Varenr.	DN	L	DKK
BP63-1	15 × 10	16	77,85
BP63-2	20 × 10	25	114,00
BP63-3	20 × 15	17	71,00
BP63-4	25 × 10	29,5	283,00
BP63-5	25 × 15	17	104,25
BP63-6	25 × 20	19,5	98,85
BP63-7	32 × 15	22	109,50
BP63-8	32 × 20	22	95,80
BP63-9	32 × 25	20	107,25
BP63-10	40 × 15	45	351,25
BP63-11	40 × 20	33,5	112,25
BP63-12	40 × 25	28	89,25
BP63-13	40 × 32	28	84,10
BP63-14	50 × 25	44	124,25
BP63-15	50 × 32	32	124,75
BP63-16	50 × 40	37	96,95
BP63-17	65 × 25	58,5	449,00
BP63-18	65 × 32	52	378,25
BP63-19	65 × 40	38	159,75
BP63-20	65 × 50	31	130,75
BP63-21	80 × 25	89,5	517,75
BP63-22	80 × 32	83	570,25
BP63-23	80 × 40	61	483,75
BP63-24	80 × 50	31,5	202,25
BP63-25	80 × 65	31,5	167,75
BP63-26	100 × 25	112	802,00
BP63-27	100 × 32	105,5	749,25
BP63-28	100 × 40	91,5	713,75
BP63-29	100 × 50	87	583,25
BP63-30	100 × 65	54	281,00
BP63-31	100 × 80	38	221,00
BP63-32	125 × 25	147,5	1367,00
BP63-33	125 × 32	141	1378,25
BP63-34	125 × 40	127	1339,00
BP63-35	125 × 50	122,5	1007,75
BP63-36	125 × 65	89,5	928,25
BP63-37	125 × 80	61	523,50
BP63-38	125 × 100	36	392,00
BP63-39	150 × 65	129	1213,50
BP63-40	150 × 80	93	1074,50
BP63-41	150 × 100	66,5	669,25
BP63-42	150 × 125	40	417,75

DIN svejse T-stk

AISI 316

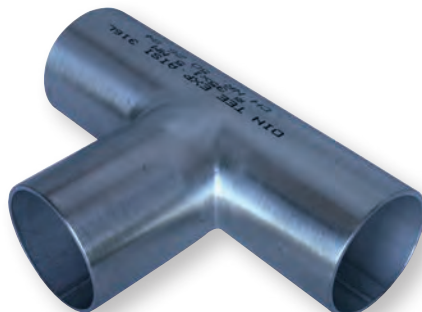

Varenr.	DN	- -	DKK
BP64-3	10	1,5	449,50
BP64-4	15	1,5	449,50
BP64-5	20	1,5	449,50
BP64-6	25	1,5	374,50
BP64-7	32	1,5	469,75
BP64-8	40	1,5	476,50
BP64-9	50	1,5	623,50
BP64-10	65	2	866,25
BP64-11	80	2	1049,75
BP64-12	100	2	1483,25
BP64-13	125	2	4804,00
BP64-14	150	2	8074,25

Rørholder tommemål

AISI 304



Til påsvejsning

Varenr.	ø	DKK
BP14-4	21,3	300,00
BP14-5	26,9	191,00
BP14-6	33,7	194,25
BP14-7	42,4	208,75
BP14-8	48,3	119,75
BP14-9	60,3	133,50
BP14-11	88,9	146,25
BP14-12	114	166,75

PUSH-IN FITTINGS POM



Se skema



-20°C til +60°C



Disse fittings er af ugiftig, harmløst materiale, der kan bruges i forbindelse med vand- og drikkevare systemer. Fødevaregodkendt.

Kan bruges til harmløse gasarter, væsker samt vacuum.

Fittings er fremstillet iht. ISO 9001 og systemets fordel er hurtig installation eller udskiftning. Stor fleksibilitet og mange anvendelsesmuligheder.

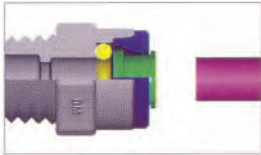

Afskær slange/rør retvinklet før indføring i fittings. Slangens/rørets ende skal være glat og ren uden dybe ridser.

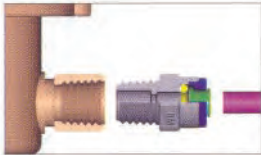

Fjern urenheder fra gevind og brug teflontape eller tilsvarende tætningsmateriale til tætning af gevind.

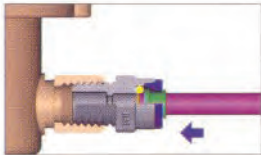

Selv om der føles modstand, skal det sikres at slangen/røret trykkes helt i bund. Brug kun fastnøglen til ispænding af fittings.

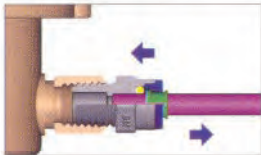

Kontroller korrekt montering ved at rykke i slange/rør.

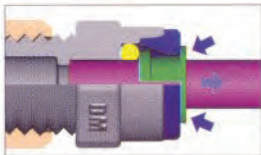

Afmontering: Pres kraven ind mod fittingsdelen og træk derefter i slangen/røret.



Den unikke ovale udførelse af kraven letter arbejdet.

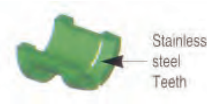

Stainless steel Teeth

Acetal



Acetal



EPDM



Acetal

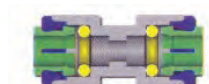

Samlet

Arbejstryk:

Dim	-20°C	0°C	20°C	60°C
4 mm	16 bar	16 bar	16 bar	10,5 bar
6 mm	16 bar	16 bar	16 bar	10,5 bar
8 mm	16 bar	16 bar	16 bar	10,5 bar
10 mm	11 bar	11 bar	11 bar	7 bar
12 mm	11 bar	11 bar	11 bar	7 bar
15 mm		12 bar	12 bar	7 bar
16 mm		12 bar	12 bar	7 bar
18 mm		15 bar	15 bar	9 bar
22 mm		15 bar	15 bar	9 bar

Fittings produceret efter følgende systemer/godkendelser:





Vores fødevarerprodukter opfylder kravene til direkte kontakt med fødevarer.

Fittings der hører til eliten!

Nippel push-in

POM (ACETAL) - BSPT



Varenr.	dim × BSPT	DKK
AD80-1	ø4 × 1/8"	13,95
AD80-2	ø4 × 1/4"	15,45
AD80-3	ø5 × 1/8"	14,85
AD80-4	ø5 × 1/4"	15,85
AD80-5	ø6 × 1/8"	16,75
AD80-6	ø6 × 1/4"	16,75
AD80-7	ø6 × 3/8"	17,10
AD80-8	ø6 × 1/2"	20,55
AD80-9	ø8 × 1/8"	17,65
AD80-10	ø8 × 1/4"	17,65
AD80-11	ø8 × 3/8"	17,65 α
AD80-12	ø10 × 1/8"	18,35
AD80-13	ø10 × 1/4"	18,35
AD80-14	ø10 × 3/8"	18,35
AD80-15	ø10 × 1/2"	21,50
AD80-16	ø12 × 3/8"	21,75
AD80-17	ø12 × 1/2"	23,65
AD80-18	ø15 × 3/8"	56,00
AD80-19	ø15 × 1/2"	60,35
AD80-20	ø16 × 3/8"	60,35
AD80-21	ø16 × 1/2"	62,55
AD80-22	ø18 × 1/2"	64,45
AD80-23	ø22 × 3/4"	66,10

α = så længe lager haves

Nippel push-in

POM (ACETAL) - BSPP



Varenr.	dim × BSPP	DKK
AD81-1	ø4 × 1/8"	14,85
AD81-2	ø4 × 1/4"	16,45
AD81-3	ø5 × 1/8"	15,85
AD81-4	ø5 × 1/4"	15,85
AD81-5	ø6 × 1/8"	17,65
AD81-6	ø6 × 1/4"	17,65
AD81-7	ø8 × 1/8"	18,65
AD81-8	ø8 × 1/4"	18,65
AD81-9	ø8 × 3/8"	18,65
AD81-9-1	ø8 × 1/2"	28,15
AD81-10	ø10 × 1/4"	19,30
AD81-11	ø10 × 3/8"	19,30
AD81-12	ø10 × 1/2"	19,65
AD81-13	ø12 × 3/8"	22,75
AD81-14	ø12 × 1/2"	25,55
AD81-15	ø15 × 1/2"	60,35
AD81-16	ø15 × 3/4"	62,30
AD81-17	ø16 × 1/2"	67,75
AD81-18	ø16 × 3/4"	67,75
AD81-20	ø22 × 3/4"	67,75

Muffe push-in

POM (ACETAL) - BSPP



Varenr.	dim × BSPP	DKK
AD82-1	ø6 × 1/8"	18,65
AD82-2	ø6 × 1/4"	18,65
AD82-5	ø6 × 1/2"	37,10
AD82-11	ø8 × 1/8"	20,75 α
AD82-12	ø8 × 1/4"	21,25
AD82-13	ø8 × 3/8"	21,15 α
AD82-10	ø8 × 1/2"	23,05
AD82-4	ø10 × 1/4"	23,40
AD82-4-1	ø10 × 3/8"	23,80 α
AD82-6-1	ø12 × 3/8"	23,50
AD82-6-2	ø12 × 1/2"	23,75
AD82-7	ø15 × 1/2"	63,05
AD82-8	ø16 × 1/2"	64,95
AD82-9	ø22 × 3/4"	73,45

α = så længe lager haves

Vinkel 90° push-in/nippel

POM (ACETAL) - BSPT



Varenr.	dim × BSPT	DKK
AD83-01	ø4 × 1/8"	15,45 α
AD83-1	ø6 × 1/8"	16,75
AD83-2	ø6 × 1/4"	16,75 α
AD83-3	ø6 × 3/8"	17,40
AD83-12	ø8 × 1/4"	18,10 α
AD83-4	ø10 × 1/4"	16,75
AD83-5	ø10 × 3/8"	17,40
AD83-7	ø12 × 1/2"	57,90
AD83-8	ø15 × 3/8"	57,90
AD83-9	ø15 × 1/2"	60,65
AD83-10	ø16 × 3/8"	60,05
AD83-11	ø16 × 1/2"	62,55

α = så længe lager haves

Vinkel 90° push-in/nip svivel

POM (ACETAL) - BSPT



Varenr.	dim × BSPT	DKK
AD84-1	ø4 × 1/8"	26,55
AD84-2	ø4 × 1/4"	26,90
AD84-3	ø5 × 1/8"	27,20
AD84-4	ø6 × 1/8"	28,70
AD84-5	ø6 × 1/4"	28,95
AD84-6	ø8 × 1/8"	31,50
AD84-7	ø8 × 1/4"	32,30
AD84-8	ø8 × 3/8"	32,55
AD84-9	ø10 × 1/4"	36,45
AD84-10	ø10 × 3/8"	37,25
AD84-11	ø12 × 3/8"	41,10
AD84-12	ø12 × 1/2"	41,70

Vinkel 90° push-in/rørende

POM (ACETAL) - BSPT



Varenr.	dim	DKK
AD85-1	ø4 × Ø4	15,20
AD85-2	ø5 × Ø5	15,85
AD85-3	ø6 × Ø6	16,75
AD85-4	ø6 × Ø10	20,90
AD85-5	ø8 × Ø8	18,65
AD85-6	ø8 × Ø10	20,90
AD85-7	ø10 × Ø10	22,50
AD85-8	ø12 × Ø12	26,55
AD85-9	ø15 × Ø15	63,05

Vinkel 90° push-in

POM (ACETAL)



Varenr.	dim	DKK
AD88-1	ø4	17,65
AD88-2	ø5	18,35
AD88-4	ø6	18,65
AD88-5	ø8 × ø4	19,30
AD88-6	ø8 × ø5	19,95
AD88-7	ø8 × ø6	20,90
AD88-8	ø8	21,20
AD88-9	ø10 × ø5	23,05
AD88-10	ø10 × ø6	23,40
AD88-11	ø10 × ø8	23,65
AD88-12	ø10	24,40
AD88-13	ø12 × ø10	27,20
AD88-14	ø12	27,45
AD88-15	ø15	102,50
AD88-16	ø16	104,75
AD88-17	ø18	124,25
AD88-18	ø22 × ø15	124,25
AD88-19	ø22 × ø16	133,00
AD88-20	ø22	142,75

Union push-in

POM (ACETAL)



Varenr.	dim	DKK
AD97-1	ø4	16,45
AD97-2	ø5	16,75
AD97-3	ø6	17,40
AD97-4	ø8 × ø5	21,75
AD97-5	ø8 × ø6	20,55
AD97-6	ø8	22,75
AD97-7	ø10 × ø5	22,15
AD97-8	ø10 × ø6	22,75
AD97-9	ø10 × ø8	23,05
AD97-10	ø10	23,40
AD97-11	ø12 × ø8	25,55
AD97-12	ø12 × ø10	26,30
AD97-13	ø12	26,55
AD97-14	ø15 × ø12	76,20
AD97-15	ø15	93,90
AD97-16	ø16 × ø12	84,10
AD97-17	ø16 × ø15	102,50
AD97-17-1	ø16 × ø16	102,50
AD97-18	ø18	109,50
AD97-19	ø22 × ø15	118,25
AD97-20	ø22	142,75

Vinkel 45° push-in red.

POM (ACETAL)



Varenr.	dim	DKK
AD86-1	ø10 × ø6	22,50
AD86-2	ø12 × ø8	23,65

T-stk push-in

POM (ACETAL)



Varenr.	dim	DKK
AD90-1	ø4	18,10
AD90-2	ø5	19,65
AD90-3	ø6	21,75
AD90-4	ø8	24,40
AD90-5	ø10 × ø6 × ø10	27,20
AD90-6	ø10	27,45
AD90-7	ø12 × ø10 × ø12	28,70
AD90-8	ø12	32,55
AD90-9	ø15	105,50
AD90-10	ø16	128,75
AD90-11	ø18	149,00
AD90-12	ø22	149,00

Nippel push-in/rørende

POM (ACETAL)



Varenr.	dim	DKK
AD96-1	ø4 × Ø5	13,95
AD96-2	ø5 × Ø6	14,15
AD96-3	ø4 × Ø6	14,15
AD96-4	ø4 × Ø8	14,60
AD96-5	ø5 × Ø8	14,15
AD96-6	ø6 × Ø8	14,60
AD96-7	ø6 × Ø10	19,30
AD96-8	ø8 × Ø10	19,95
AD96-9	ø8 × Ø12	20,55
AD96-10	ø10 × Ø12	26,90
AD96-11	ø10 × Ø15	51,65
AD96-12	ø12 × Ø15	56,00

Skotgennemføring push-in

POM (ACETAL)



Varenr.	dim	Ext. dim	DKK
AD98-1	ø4	M15*1	19,65 □
AD98-2	ø5	M16*1	20,90
AD98-3	ø6	M17*1,5	26,00
AD98-3-1	ø6 × ø4	M17*1,5	26,50 □
AD98-4	ø8	M20*1,75	26,90
AD98-4-1	ø8 × ø6	M20*1,75	27,60 □
AD98-6	ø10	M24*1,75	28,70
AD98-5	ø10 × ø6	M20*1,5	28,15
AD98-7	ø12	M27*2	37,50

□ = så længe lager haves

Nippel m. rørende

POM (ACETAL) - BSPP



Varenr.	dim × BSPP	DKK
AD105C-1	Ø4 × 1/8"	9,55
AD105C-2	Ø4 × 1/4"	9,80
AD105C-3	Ø5 × 1/8"	10,00
AD105C-4	Ø5 × 1/4"	10,10
AD105C-5	Ø6 × 1/8"	10,45
AD105C-6	Ø6 × 1/4"	10,80
AD105C-7	Ø8 × 1/8"	11,10
AD105C-8	Ø8 × 1/4"	11,70
AD105C-9	Ø8 × 3/8"	12,15
AD105C-10	Ø10 × 1/4"	12,95
AD105C-11	Ø10 × 3/8"	13,95
AD105C-12	Ø10 × 1/2"	13,95
AD105C-13	Ø12 × 3/8"	14,60
AD105C-14	Ø12 × 1/2"	15,20
AD105C-15	Ø15 × 3/8"	28,15
AD105C-16	Ø15 × 1/2"	30,65
AD105C-17	Ø18 × 1/2"	59,25

Nippel m. rørende

POM (ACETAL) - BSPT



Varenr.	dim × BSPT	DKK
AD105K-1	Ø4 × 1/8"	9,55
AD105K-2	Ø4 × 1/4"	9,80
AD105K-3	Ø5 × 1/8"	10,00
AD105K-4	Ø5 × 1/4"	10,10
AD105K-5	Ø6 × 1/8"	10,45
AD105K-6	Ø6 × 1/4"	10,80
AD105K-7	Ø6 × 3/8"	11,55
AD105K-8	Ø8 × 1/8"	11,10
AD105K-9	Ø8 × 1/4"	11,70
AD105K-10	Ø8 × 3/8"	12,15
AD105K-11	Ø10 × 1/4"	12,95
AD105K-12	Ø10 × 3/8"	13,95
AD105K-13	Ø10 × 1/2"	13,95
AD105K-14	Ø12 × 3/8"	14,60
AD105K-15	Ø12 × 1/2"	15,20

Kryds push-in

POM (ACETAL)



Varenr.	dim	DKK
AD95-1	ø4	32,55
AD95-2	ø6	36,20
AD95-3	ø8	39,15
AD95-4	ø10	41,45
AD95-5	ø12	49,65

U-bøjning push-in

POM (ACETAL)



Varenr.	dim	DKK
AD112-1	ø6	20,90
AD112-2	ø8	25,30
AD112-3	ø10	26,55
AD112-4	ø12	28,15
AD112-5	ø15	49,95
AD112-6	ø16	59,50

Y-stk push-in

POM (ACETAL)



Varenr.	dim	DKK
AD111-1	ø4 × 2-ø4	22,75
AD111-2	ø6 × 2-ø6	25,30
AD111-3	ø8 × 2-ø8	26,55
AD111-4	ø10 × 2-ø8	29,25
AD111-5	ø10 × 2-ø10	27,65
AD111-6	ø12 × 2-ø12	32,55
AD111-7	ø10 × 2-ø12	31,20

Slangenippel m. rørende

POM (ACETAL)



Varenr.	A × B	DKK
AD110-1	Ø6 × Ø4	10,10
AD110-2	Ø8 × Ø6	11,45
AD110-3	Ø10 × Ø8	12,95
AD110-4	Ø12 × Ø10	13,05

Fordeler push-in

POM (ACETAL)



Varenr.	dim	DKK
AD109-1	ø10 × 3-ø6	59,50
AD109-2	ø12 × 3-ø10	68,25

Slutmuffe push-in

POM (ACETAL)



Varenr.	dim	DKK
AD108-2	ø5	6,35
AD108-3	ø6	6,35
AD108-4	ø8	6,65
AD108-5	ø10	7,20
AD108-6	ø12	7,90
AD108-7	ø15	19,80
AD108-8	ø22	33,10

Prop push-in POM (ACETAL)



Varenr.	dim	DKK
AD99-1	Ø4	6,35
AD99-2	Ø5	6,35
AD99-3	Ø6	6,35
AD99-4	Ø8	6,65
AD99-5	Ø10	7,20
AD99-6	Ø12	7,90
AD99-7	Ø15	15,85
AD99-9	Ø18	19,00
AD99-10	Ø22	23,05

Filter push-in POM (ACETAL)



Inkl. 100mesh filter

Varenr.	dim	DKK
AD116-3	ø6	117,75
AD116-4	ø8	124,75
AD116-5	ø10	134,50
AD116-6	ø12	142,75

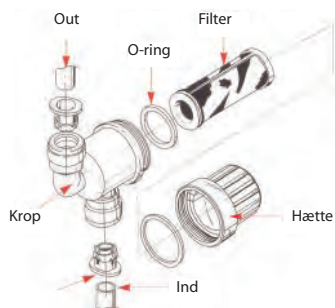

Kontraventil push-in POM (ACETAL)



Dobbeltvirkende

Varenr.	dim	DKK
AD122-1	ø15	182,25

Slangestuds push-in POM (ACETAL)



Varenr.	dim × dim	DKK
AD123-1	ø15 × 1/2"	28,40
AD123-2	ø22 × 1/2"	32,30
AD123-3	ø22 × 3/4"	33,40

Kontraventil push-in POM (ACETAL)



Varenr.	dim	DKK
AD113-3	ø6	147,25
AD113-4	ø8	157,75
AD113-5	ø10	176,50
AD113-6	ø12	196,75

Ventil push-in POM (ACETAL)



Varenr.	dim	DKK
AD120-6	ø6	87,65
AD120-8	ø8	87,65
AD120-0	ø10	89,60
AD120-12	ø12	96,95
AD120-1	ø15	132,50
AD120-2	ø15 × ø10	248,75
AD120-3	ø16	200,00
AD120-4	ø16 × ø10	200,00
AD120-5	ø22	248,75

Push-in sikkerhedsring



Varenr.	dim	DKK
AD125-00	ø4	1,44
AD125-01	ø6	3,14
AD125-1-1	ø8	3,36
AD125-1-1-0	ø10	3,69
AD125-1-2	ø12	3,69
AD125-1	ø15	2,37
AD125-2	ø16	2,37
AD125-4	ø22	2,37

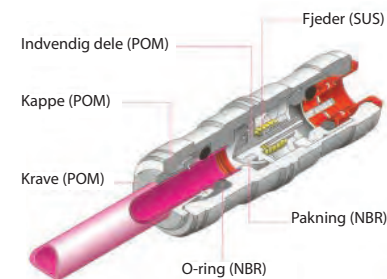

Ventil 90° push-in/muffe POM (ACETAL) - BSPP



Varenr.	dim × BSPP	DKK
AD115-3	ø6 × 1/4"	133,00
AD115-5	ø10 × 3/8"	170,25
AD115-7	ø12 × 1/2"	262,00

Ventil push-in POM (ACETAL)



Varenr.	dim	DKK
AD121-1	ø15	65,55

Tankforbindelse push-in POM (ACETAL)



Varenr.	dim	Ext. dim	DKK
AD126-1	ø15	M30*3,5	52,70
AD126-2	ø22	M39*3,5	60,05

VENTILER FØDEVAREGODKENDT



Max 1 bar



+0 til +40°C



Ventil

PVDF (POLYVINYLIDENFLUORID)



Varenr.	Ø	Lysning	DKK
A30-20	5-7	4	314,00
A30-21	7-9	6	373,25
A30-22	9-11	8	437,75
A30-23	11-13	8	425,00

3-vejs ventil

PVDF (POLYVINYLIDENFLUORID)



Både L og T boret

Varenr.	Ø	Lysning	DKK
A30-40	5-7	4	493,00
A30-41	7-9	6	555,75
A30-42	9-11	8	611,50
A30-43	11-13	8	611,50

VARERNE TIL TIDEN OG OGSÅ DE RIGTIGE VARER TIL TIDEN

Vi forsøger konstant at udvikle vores leveringer og med mere end 1.600.000 fittings på lager, kræver det god orden og styr på tingene.

Vi har igennem de sidste år gjort store investinger i at køre vores lager så effektivt som muligt.

Vi har på nuværende tidspunkt alle fittings, ventiler og ... liggende inde i vores automatiske lagersystem, der rummer mere end 80.000 kasser med fittings.

Lad os hjælpe dig med få tingene til tiden, så du slipper for at bruge tid på restordre og lignende.

Hvis vi ved, hvad og hvor meget, du skal bruge, sikrer vi, at dine fittings konstant er på lager, således du ikke løber tør i din produktion eller til dit projekt.



Kompatibilitetsoversigt

[KLIK HER](#)

KOBLINGER



88

CAMLOCK KOBLINGER
RUSTFRI AISI 316



90

CAMLOCK KOBLINGER
RUSTFRI AISI 316 M/LÅS



92

CAMLOCK KOBLINGER
ALUMINIUM



94

CAMLOCK KOBLINGER
MESSING



96

CAMLOCK KOBLINGER
PP



98

CAMLOCK KOBLINGER
NYLON



100

CAMLOCK TILBEHØR



102

KLOKOBLINGER
TIL VAND "TYPE GEKA"



105

KLOKOBLINGER
TIL LUFT



106

NITO KOBLINGER
TIL VAND



108

GEKA LYNKOBLINGER
TIL VAND



109

SLANGESTUDS-
KOBLINGER MESSING



110

TW KOBLINGER



113

STORZ KOBLINGER



115

SLANGEKOBLINGER



116

KOBLINGER
TYPE "BAUER"



121

LYNKOBLING
SERIE 200 MINI



122

LYNKOBLING
SERIE 210 MIGNON



124

LYNKOBLING
SERIE 210 MIGNON DOBB.



126

LYNKOBLING
SERIE 220 NORMA



128

LYNKOBLING
SERIE 230 NORMA



130

LYNKOBLING
SERIE 240 NORMA



132

LYNKOBLING
SERIE 260 TEDESCO



134

LYNKOBLING
SERIE 520 JWL



135

LYNKOBLING
SERIE 270 SVENSK



137

LYNKOBLING
SERIE 410-510



138

LYNKOBLING
SERIE 660 EUROPÆISK



139

LYNKOBLING
SERIE 670 SVENSK



140

LYNKOBLING
SERIE 800 MINI



141

LYNKOBLING
ISO B



142

LYNKOBLING
PLASTIK



143

JWL KOBLINGER OG
TRYKLUFTPISTOLER

CAMLOCK KOBLINGER RUSTFRI AISI 316



Bredt program af Camlock koblinger i henhold til US mil-c-27487. Camlock koblinger er en sikker kobling til brug sammen med slanger og rør til mange forskellige medier som f.eks tørstoffer, kølevand, brændstof, kemikalier, kosmetik, lim, piller og meget andet. Koblingen tilsluttes nemt ved at åbne vingerne og indsætte han-delen for derefter at lukke

vingerne ved normal håndkraft.

Max tryk (ved 21°C):

- 1/2" = 10 bar
- 3/4"-2" = 17bar
- 2½" = 10bar
- 3" = 8bar
- 4" = 7bar
- 6" = 5bar



Camlock F han m. udv. gevind
AISI 316 - BSPP



Varenr.	BSPP	Krop	DKK
B65-4	1/2"	050 ~ 1/2"	183,00
B65-5	3/4"	075 ~ 3/4"	190,50
B65-6	1"	100 ~ 1"	249,25
B65-7	1 1/4"	125 ~ 1 1/4"	353,75
B65-8	1 1/2"	150 ~ 1 1/2"	417,50
B65-9	2"	200 ~ 2"	547,25
B65-10	2 1/2"	250 ~ 2 1/2"	891,00
B65-11	3"	300 ~ 3"	1105,25
B65-12	4"	400 ~ 4"	1671,75
B65-13	5"	500 ~ 5"	1827,25
B65-14	6"	600 ~ 6"	1979,75

Camlock A han m. indv. gevind
AISI 316 - BSPP



Varenr.	BSPP	Krop	DKK
B60-4	1/2"	050 ~ 1/2"	147,25
B60-5	3/4"	075 ~ 3/4"	147,25
B60-6	1"	100 ~ 1"	201,75
B60-7	1 1/4"	125 ~ 1 1/4"	251,50
B60-8	1 1/2"	150 ~ 1 1/2"	310,25
B60-9	2"	200 ~ 2"	400,75
B60-10	2 1/2"	250 ~ 2 1/2"	658,00
B60-11	3"	300 ~ 3"	769,00
B60-12	4"	400 ~ 4"	1172,25
B60-13	5"	500 ~ 5"	1293,75
B60-14	6"	600 ~ 6"	1439,00

Camlock B hun m/udv. gevind

AISI 316 - BSPP



Håndtag = AISI 304, pakning = NBR

Varenr.	BSPP	Krop	DKK
B61-4	1/2"	050 ~ 1/2"	262,25
B61-5	3/4"	075 ~ 3/4"	262,25
B61-6	1"	100 ~ 1"	323,75
B61-7	1 1/4"	125 ~ 1 1/4"	492,00
B61-8	1 1/2"	150 ~ 1 1/2"	506,25
B61-9	2"	200 ~ 2"	604,25
B61-10	2 1/2"	250 ~ 2 1/2"	943,00
B61-11	3"	300 ~ 3"	1149,50
B61-12	4"	400 ~ 4"	1580,25
B61-13	5"	500 ~ 5"	1686,25
B61-14	6"	600 ~ 6"	1843,75

Camlock C hun m. studs

AISI 316



Håndtag = AISI 304, pakning = NBR

Varenr.	Ø × dim	DKK
B62-4	12 × 050 ~ 1/2"	232,25
B62-5	19 × 075 ~ 3/4"	232,25
B62-6	25 × 100 ~ 1"	307,75
B62-7	32 × 125 ~ 1 1/4"	456,75
B62-8	38 × 150 ~ 1 1/2"	482,50
B62-9	52 × 200 ~ 2"	631,50
B62-10	62 × 250 ~ 2 1/2"	992,25
B62-11	77 × 300 ~ 3"	1205,25
B62-12	102 × 400 ~ 4"	1580,25
B62-13	127 × 500 ~ 5"	1744,00
B62-14	153 × 600 ~ 6"	1918,00

Camlock DC dæksel

AISI 316



Håndtag = AISI 304, pakning = NBR

Varenr.	Str.	DKK
B66-4	050 ~ 1/2"	212,00
B66-5	075 ~ 3/4"	212,00
B66-6	100 ~ 1"	268,25
B66-7	125 ~ 1 1/4"	400,75
B66-8	150 ~ 1 1/2"	423,50
B66-9	200 ~ 2"	488,50
B66-10	250 ~ 2 1/2"	747,25
B66-11	300 ~ 3"	888,75
B66-12	400 ~ 4"	1451,50
B66-13	500 ~ 5"	1473,00
B66-14	600 ~ 6"	1507,00

Camlock D hun m/indv. gevind

AISI 316 - BSPP



Håndtag = AISI 304, pakning = NBR

Varenr.	BSPP	Krop	DKK
B63-4	1/2"	050 ~ 1/2"	285,75
B63-5	3/4"	075 ~ 3/4"	285,75
B63-6	1"	100 ~ 1"	353,75
B63-7	1 1/4"	125 ~ 1 1/4"	503,75
B63-8	1 1/2"	150 ~ 1 1/2"	566,50
B63-9	2"	200 ~ 2"	623,50
B63-10	2 1/2"	250 ~ 2 1/2"	1011,50
B63-11	3"	300 ~ 3"	1190,75
B63-12	4"	400 ~ 4"	1687,25
B63-13	5"	500 ~ 5"	1906,75
B63-14	6"	600 ~ 6"	2118,75

Camlock E han m. studs

AISI 316



Håndtag = AISI 304, pakning = NBR

Varenr.	Ø × dim	DKK
B64-4	12 × 050 ~ 1/2"	136,75
B64-5	19 × 075 ~ 3/4"	136,75
B64-6	25 × 100 ~ 1"	219,25
B64-7	32 × 125 ~ 1 1/4"	290,00
B64-8	38 × 150 ~ 1 1/2"	383,75
B64-9	52 × 200 ~ 2"	594,50
B64-10	62 × 250 ~ 2 1/2"	814,75
B64-11	77 × 300 ~ 3"	1112,50
B64-12	102 × 400 ~ 4"	1553,25
B64-13	127 × 500 ~ 5"	1686,25
B64-14	153 × 600 ~ 6"	1866,50

Camlock DP prop

AISI 316



Håndtag = AISI 304, pakning = NBR

Varenr.	Str.	DKK
B67-4	050 ~ 1/2"	105,00
B67-5	075 ~ 3/4"	105,00
B67-6	100 ~ 1"	151,75
B67-7	125 ~ 1 1/4"	207,00
B67-8	150 ~ 1 1/2"	257,50
B67-9	200 ~ 2"	348,75
B67-10	250 ~ 2 1/2"	552,50
B67-11	300 ~ 3"	678,75
B67-12	400 ~ 4"	1064,00
B67-13	500 ~ 5"	1209,25
B67-14	600 ~ 6"	1353,50

CAMLOCK KOBLINGER RUSTFRI AISI 316 MED LÅS



Se tekst



Bredt program af Camlock koblinger i henhold til US mil-c-27487. Camlock koblinger er en sikker kobling til brug sammen med slanger og rør til mange forskellige medier som f.eks tørstoffer, kølevand, brændstof, kemikalier, kosmetik, lim, piller og meget andet. Koblingen tilsluttes nemt ved at åbne vingerne og indsætte han-delen for derefter at lukke

vingerne ved normal håndkraft.

Max tryk (ved 21°C):

- 1/2" = 10 bar
- 3/4"-2" = 17bar
- 2½" = 10bar
- 3" = 8bar
- 4" = 7bar
- 6" = 5bar

Camlock F han m. udv. gevind

AISI 316 - BSPP



Varenr.	BSPP	Krop	DKK
B65-4	1/2"	050 ~ 1/2"	183,00
B65-5	3/4"	075 ~ 3/4"	190,50
B65-6	1"	100 ~ 1"	249,25
B65-7	1 1/4"	125 ~ 1 1/4"	353,75
B65-8	1 1/2"	150 ~ 1 1/2"	417,50
B65-9	2"	200 ~ 2"	547,25
B65-10	2 1/2"	250 ~ 2 1/2"	891,00
B65-11	3"	300 ~ 3"	1105,25
B65-12	4"	400 ~ 4"	1671,75
B65-13	5"	500 ~ 5"	1827,25
B65-14	6"	600 ~ 6"	1979,75

Camlock A han m. indiv. gevind

AISI 316 - BSPP



Varenr.	BSPP	Krop	DKK
B60-4	1/2"	050 ~ 1/2"	147,25
B60-5	3/4"	075 ~ 3/4"	147,25
B60-6	1"	100 ~ 1"	201,75
B60-7	1 1/4"	125 ~ 1 1/4"	251,50
B60-8	1 1/2"	150 ~ 1 1/2"	310,25
B60-9	2"	200 ~ 2"	400,75
B60-10	2 1/2"	250 ~ 2 1/2"	658,00
B60-11	3"	300 ~ 3"	769,00
B60-12	4"	400 ~ 4"	1172,25
B60-13	5"	500 ~ 5"	1293,75
B60-14	6"	600 ~ 6"	1439,00



Camlock B hun m/udv. gevind

AISI 316 - BSPP



Låsbar håndtag = AISI 304, pakning = NBR

Varenr.	BSPP	Krop	DKK
B61-6-LOCK	1"	100 ~ 1"	354,00
B61-7-LOCK	1 1/4"	125 ~ 1 1/4"	537,25
B61-8-LOCK	1 1/2"	150 ~ 1 1/2"	627,00
B61-9-LOCK	2"	200 ~ 2"	752,25
B61-10-LOCK	2 1/2"	250 ~ 2 1/2"	1033,25
B61-11-LOCK	3"	300 ~ 3"	1426,75
B61-12-LOCK	4"	400 ~ 4"	1889,25

Camlock C hun med studs

AISI 316



Låsbar håndtag = AISI 304, pakning = NBR

Varenr.	Ø × dim	Krop	DKK
B62-6-LOCK	1"	100 ~ 1"	387,75
B62-7-LOCK	1 1/4"	125 ~ 1 1/4"	562,50
B62-8-LOCK	1 1/2"	150 ~ 1 1/2"	655,25
B62-9-LOCK	2"	200 ~ 2"	825,00
B62-10-LOCK	2 1/2"	250 ~ 2 1/2"	1153,75
B62-11-LOCK	3"	300 ~ 3"	1763,50
B62-12-LOCK	4"	400 ~ 4"	2226,00

Camlock DC dæksel

AISI 316



Låsbar håndtag = AISI 304, pakning = NBR

Varenr.	Str.	Krop	DKK
B66-6-LOCK	1"	100 ~ 1"	320,00
B66-7-LOCK	1 1/4"	125 ~ 1 1/4"	501,25
B66-8-LOCK	1 1/2"	150 ~ 1 1/2"	555,75
B66-9-LOCK	2"	200 ~ 2"	708,75
B66-10-LOCK	2 1/2"	250 ~ 2 1/2"	896,00
B66-11-LOCK	3"	300 ~ 3"	1171,25
B66-12-LOCK	4"	400 ~ 4"	1572,00

Camlock D hun m/indv. gevind

AISI 316 - BSPP



Låsbar håndtag = AISI 304, pakning = NBR

Varenr.	BSPP	Krop	DKK
B63-6-LOCK	1"	100 ~ 1"	362,75
B63-7-LOCK	1 1/4"	125 ~ 1 1/4"	546,00
B63-8-LOCK	1 1/2"	150 ~ 1 1/2"	644,50
B63-9-LOCK	2"	200 ~ 2"	783,00
B63-10-LOCK	2 1/2"	250 ~ 2 1/2"	1026,50
B63-11-LOCK	3"	300 ~ 3"	1400,00
B63-12-LOCK	4"	400 ~ 4"	1967,50

Camlock E han med studs

AISI 316



Varenr.	Ø × dim	DKK
B64-4	12 × 050 ~ 1/2"	136,75
B64-5	19 × 075 ~ 3/4"	136,75
B64-6	25 × 100 ~ 1"	219,25
B64-7	32 × 125 ~ 1 1/4"	290,00
B64-8	38 × 150 ~ 1 1/2"	383,75
B64-9	52 × 200 ~ 2"	594,50
B64-10	62 × 250 ~ 2 1/2"	814,75
B64-11	77 × 300 ~ 3"	1112,50
B64-12	102 × 400 ~ 4"	1553,25
B64-13	127 × 500 ~ 5"	1686,25
B64-14	153 × 600 ~ 6"	1866,50

Camlock DP prop

AISI 316



Varenr.	Str.	DKK
B67-4	050 ~ 1/2"	105,00
B67-5	075 ~ 3/4"	105,00
B67-6	100 ~ 1"	151,75
B67-7	125 ~ 1 1/4"	207,00
B67-8	150 ~ 1 1/2"	257,50
B67-9	200 ~ 2"	348,75
B67-10	250 ~ 2 1/2"	552,50
B67-11	300 ~ 3"	678,75
B67-12	400 ~ 4"	1064,00
B67-13	500 ~ 5"	1209,25
B67-14	600 ~ 6"	1353,50

CAMLOCK KOBLINGER ALUMINIUM



Se tekst



Bredt program af Camlock koblinger i henhold til US mil-c-27487. Camlock koblinger er en sikker kobling til brug sammen med slanger og rør til mange forskellige medier som f.eks tørstoffer, kølevand, brændstof, kemikalier, kosmetik, lim, piller og meget andet. Koblingen tilsluttes nemt ved at åbne vingerne og indsætte han-delen for derefter at lukke

vingerne ved normal håndkraft.

Max tryk (ved 21°C):

- 1/2" = 10 bar
- 3/4"-2" = 17bar
- 2½" = 10bar
- 3" = 8bar
- 4" = 7bar
- 6" = 5bar

Camlock F han m. udv. gevind

ALUMINIUM - BSPT



Varenr.	BSPP	Krop	DKK
B65-4A	1/2"	050 ~ 1/2"	76,70
B65-5A	3/4"	075 ~ 3/4"	71,25
B65-6A	1"	100 ~ 1"	77,55
B65-7A	1 1/4"	125 ~ 1 1/4"	95,55
B65-8A	1 1/2"	150 ~ 1 1/2"	89,00
B65-9A	2"	200 ~ 2"	114,50
B65-10A	2 1/2"	250 ~ 2 1/2"	237,25
B65-11A	3"	300 ~ 3"	247,75
B65-12A	4"	400 ~ 4"	361,00
B65-13A	5"	500 ~ 5"	399,50
B65-14A	6"	600 ~ 6"	439,75

Camlock A han m. indv. gevind

ALUMINIUM - BSPP



Varenr.	BSPP	Krop	DKK
B60-4A	1/2"	050 ~ 1/2"	66,10
B60-5A	3/4"	075 ~ 3/4"	62,00
B60-6A	1"	100 ~ 1"	66,60
B60-7A	1 1/4"	125 ~ 1 1/4"	85,45
B60-8A	1 1/2"	150 ~ 1 1/2"	80,25
B60-9A	2"	200 ~ 2"	89,00
B60-10A	2 1/2"	250 ~ 2 1/2"	162,50
B60-11A	3"	300 ~ 3"	180,75
B60-12A	4"	400 ~ 4"	276,00
B60-13A	5"	500 ~ 5"	158,75
B60-14A	6"	600 ~ 6"	216,50

Camlock B hun m/udv. gevind

ALUMINIUM - BSPP



Håndtag = AISI 304, pakning = NBR

Varenr.	BSPP	Krop	DKK
B61-4A	1/2"	050 ~ 1/2"	147,25
B61-5A	3/4"	075 ~ 3/4"	119,75
B61-6A	1"	100 ~ 1"	149,25
B61-7A	1 1/4"	125 ~ 1 1/4"	203,00
B61-8A	1 1/2"	150 ~ 1 1/2"	184,00
B61-9A	2"	200 ~ 2"	219,25
B61-10A	2 1/2"	250 ~ 2 1/2"	327,25
B61-11A	3"	300 ~ 3"	359,75
B61-12A	4"	400 ~ 4"	464,50
B61-13A	5"	500 ~ 5"	573,75
B61-14A	6"	600 ~ 6"	674,00

Camlock C hun med studs

ALUMINIUM



Håndtag = AISI 304, pakning = NBR

Varenr.	Ø × dim	DKK
B62-4A	12 × 050 ~ 1/2"	131,50
B62-5A	19 × 075 ~ 3/4"	110,50
B62-6A	25 × 100 ~ 1"	136,75
B62-7A	32 × 125 ~ 1 1/4"	198,50
B62-8A	38 × 150 ~ 1 1/2"	185,25
B62-9A	52 × 200 ~ 2"	219,25
B62-10A	62 × 250 ~ 2 1/2"	341,75
B62-11A	77 × 300 ~ 3"	358,75
B62-12A	102 × 400 ~ 4"	495,25
B62-13A	127 × 500 ~ 5"	506,00
B62-14A	153 × 600 ~ 6"	539,50

Camlock DC dæksel

ALUMINIUM



Håndtag = AISI 304, pakning = NBR

Varenr.	Str.	DKK
B66-4A	050 ~ 1/2"	127,00
B66-5A	075 ~ 3/4"	113,00
B66-6A	100 ~ 1"	125,75
B66-7A	125 ~ 1 1/4"	171,00
B66-8A	150 ~ 1 1/2"	166,25
B66-9A	200 ~ 2"	183,00
B66-10A	250 ~ 2 1/2"	263,50
B66-11A	300 ~ 3"	287,75
B66-12A	400 ~ 4"	404,50
B66-13A	500 ~ 5"	422,00
B66-14A	600 ~ 6"	449,00

Camlock D hun m/indv. gevind

ALUMINIUM - BSPP



Håndtag = AISI 304, pakning = NBR

Varenr.	BSPP	Krop	DKK
B63-4A	1/2"	050 ~ 1/2"	149,25
B63-5A	3/4"	075 ~ 3/4"	125,75
B63-6A	1"	100 ~ 1"	151,75
B63-7A	1 1/4"	125 ~ 1 1/4"	213,00
B63-8A	1 1/2"	150 ~ 1 1/2"	185,25
B63-9A	2"	200 ~ 2"	223,75
B63-10A	2 1/2"	250 ~ 2 1/2"	344,50
B63-11A	3"	300 ~ 3"	378,00
B63-12A	4"	400 ~ 4"	520,50
B63-13A	5"	500 ~ 5"	618,75
B63-14A	6"	600 ~ 6"	731,50

Camlock E han med studs

ALUMINIUM



Håndtag = AISI 304, pakning = NBR

Varenr.	Ø × dim	DKK
B64-4A	12 × 050 ~ 1/2"	70,15
B64-5A	19 × 075 ~ 3/4"	60,05
B64-6A	25 × 100 ~ 1"	71,25
B64-7A	32 × 125 ~ 1 1/4"	89,85
B64-8A	38 × 150 ~ 1 1/2"	92,00
B64-9A	52 × 200 ~ 2"	128,75
B64-10A	62 × 250 ~ 2 1/2"	224,75
B64-11A	77 × 300 ~ 3"	241,75
B64-12A	102 × 400 ~ 4"	379,00
B64-13A	127 × 500 ~ 5"	410,50
B64-14A	153 × 600 ~ 6"	439,75

Camlock DP prop

ALUMINIUM



Varenr.	Str.	DKK
B67-4A	050 ~ 1/2"	48,75
B67-5A	075 ~ 3/4"	48,75
B67-6A	100 ~ 1"	52,40
B67-7A	125 ~ 1 1/4"	61,15
B67-8A	150 ~ 1 1/2"	64,20
B67-9A	200 ~ 2"	84,90
B67-10A	250 ~ 2 1/2"	133,25
B67-11A	300 ~ 3"	150,75
B67-12A	400 ~ 4"	231,00
B67-13A	500 ~ 5"	237,00
B67-14A	600 ~ 6"	242,75

CAMLOCK KOBLINGER MESSING



Se tekst



Bredt program af Camlock koblinger i henhold til US mil-c-27487. Camlock koblinger er en sikker kobling til brug sammen med slanger og rør til mange forskellige medier som f.eks tørstoffer, kølevand, brændstof, kemikalier, kosmetik, lim, piller og meget andet. Koblingen tilsluttes nemt ved at åbne vingerne og indsætte han-delen for derefter at lukke

vingerne ved normal håndkraft.

Max tryk (ved 21°C):

1/2" = 10 bar
 3/4"-2" = 17bar
 2½" = 10bar
 3" = 8bar
 4" = 7bar
 6" = 5bar

KOBLINGER

Camlock F han m. udv. gevind

MESSING - BSPP



Varenr.	BSPP	Krop	DKK
B65-4M	1/2"	050 ~ 1/2"	147,25
B65-5M	3/4"	075 ~ 3/4"	147,25
B65-6M	1"	100 ~ 1"	187,50
B65-7M	1 1/4"	125 ~ 1 1/4"	254,00
B65-8M	1 1/2"	150 ~ 1 1/2"	244,00
B65-9M	2"	200 ~ 2"	272,50
B65-10M	2 1/2"	250 ~ 2 1/2"	581,00
B65-11M	3"	300 ~ 3"	684,75
B65-12M	4"	400 ~ 4"	1105,25

Camlock A han m. indiv. gevind

MESSING - BSPP



Varenr.	BSPP	Krop	DKK
B60-4M	1/2"	050 ~ 1/2"	131,50
B60-5M	3/4"	075 ~ 3/4"	131,50
B60-6M	1"	100 ~ 1"	153,25
B60-7M	1 1/4"	125 ~ 1 1/4"	199,50
B60-8M	1 1/2"	150 ~ 1 1/2"	236,25
B60-9M	2"	200 ~ 2"	301,00
B60-10M	2 1/2"	250 ~ 2 1/2"	462,00
B60-11M	3"	300 ~ 3"	523,25
B60-12M	4"	400 ~ 4"	960,25



Camlock B hun m/udv. gevind

MESSING - BSPP



Håndtag = AISI 304, pakning = NBR

Varenr.	BSPP	Krop	DKK
B61-4M	1/2"	050 ~ 1/2"	280,75
B61-5M	3/4"	075 ~ 3/4"	280,75
B61-6M	1"	100 ~ 1"	340,25
B61-7M	1 1/4"	125 ~ 1 1/4"	408,25
B61-8M	1 1/2"	150 ~ 1 1/2"	440,25
B61-9M	2"	200 ~ 2"	445,00
B61-10M	2 1/2"	250 ~ 2 1/2"	528,00
B61-11M	3"	300 ~ 3"	888,75
B61-12M	4"	400 ~ 4"	1179,50

Camlock C hun med studs

MESSING



Håndtag = AISI 304, pakning = NBR

Varenr.	Ø × dim	DKK
B62-4M	12 × 050 ~ 1/2"	285,75
B62-5M	19 × 075 ~ 3/4"	285,75
B62-6M	25 × 100 ~ 1"	320,25
B62-7M	32 × 125 ~ 1 1/4"	404,50
B62-8M	38 × 150 ~ 1 1/2"	440,25
B62-9M	52 × 200 ~ 2"	528,00
B62-10M	62 × 250 ~ 2 1/2"	703,75
B62-11M	77 × 300 ~ 3"	911,75
B62-12M	102 × 400 ~ 4"	1322,75

Camlock DC dæksel

MESSING



Håndtag = AISI 304, pakning = NBR

Varenr.	Str.	DKK
B66-4M	050 ~ 1/2"	391,75
B66-5M	075 ~ 3/4"	391,75
B66-6M	100 ~ 1"	307,75
B66-7M	125 ~ 1 1/4"	374,00
B66-8M	150 ~ 1 1/2"	401,75
B66-9M	200 ~ 2"	436,50
B66-10M	250 ~ 2 1/2"	560,75
B66-11M	300 ~ 3"	758,00
B66-12M	400 ~ 4"	1047,75

Camlock D hun m/indv. gevind

MESSING - BSPP



Håndtag = AISI 304, pakning = NBR

Varenr.	BSPP	Krop	DKK
B63-4M	1/2"	050 ~ 1/2"	297,00
B63-5M	3/4"	075 ~ 3/4"	297,00
B63-6M	1"	100 ~ 1"	332,00
B63-7M	1 1/4"	125 ~ 1 1/4"	408,25
B63-8M	1 1/2"	150 ~ 1 1/2"	441,50
B63-9M	2"	200 ~ 2"	528,00
B63-10M	2 1/2"	250 ~ 2 1/2"	714,50
B63-11M	3"	300 ~ 3"	942,00
B63-12M	4"	400 ~ 4"	1335,00

Camlock E han med studs

MESSING



Varenr.	Ø × dim	DKK
B64-4M	12 × 050 ~ 1/2"	147,25
B64-5M	19 × 075 ~ 3/4"	147,25
B64-6M	25 × 100 ~ 1"	171,00
B64-7M	32 × 125 ~ 1 1/4"	217,00
B64-8M	38 × 150 ~ 1 1/2"	244,00
B64-9M	52 × 200 ~ 2"	378,00
B64-10M	62 × 250 ~ 2 1/2"	449,00
B64-11M	77 × 300 ~ 3"	742,50
B64-12M	102 × 400 ~ 4"	1108,50

Camlock DP prop

MESSING



Varenr.	Str.	DKK
B67-4M	050 ~ 1/2"	133,25
B67-5M	075 ~ 3/4"	133,25
B67-6M	100 ~ 1"	166,25
B67-7M	125 ~ 1 1/4"	168,50
B67-8M	150 ~ 1 1/2"	173,25
B67-9M	200 ~ 2"	185,25
B67-10M	250 ~ 2 1/2"	233,75
B67-11M	300 ~ 3"	310,25
B67-12M	400 ~ 4"	365,00

CAMLOCK KOBLINGER PP



Se tekst



Bredt program af Camlock koblinger i henhold til US mil-c-27487. Camlock koblinger er en sikker kobling til brug sammen med slanger og rør til mange forskellige medier som f.eks tørstoffer, kølevand, brændstof, kemikalier, kosmetik, lim, piller og meget andet. Koblingen tilsluttes nemt ved at åbne vingerne og indsætte han-delen for derefter at lukke

vingerne ved normal håndkraft.

Max tryk (ved 21°C):

1/2"-1" = 8bar

1 1/4"-2" = 7bar

3" = 5bar

4" = 3,4bar

KOBLINGER

Camlock F han m. udv. gevind PP (POLYPROPYLEN)



Varenr.	BSPP	Krop	DKK
B65-4PP	1/2"	050 ~ 1/2"	50,35
B65-5PP	3/4"	075 ~ 3/4"	50,35
B65-6PP	1"	100 ~ 1"	50,35
B65-7PP	1 1/4"	125 ~ 1 1/4"	50,35
B65-8PP	1 1/2"	150 ~ 1 1/2"	58,45
B65-9PP	2"	200 ~ 2"	72,65
B65-10PP	2 1/2"	250 ~ 2 1/2"	145,25
B65-11PP	3"	300 ~ 3"	145,25
B65-12PP	4"	400 ~ 4"	285,75

Camlock A han m. indv. gevind PP (POLYPROPYLEN) - BSPP



Varenr.	BSPP	Krop	DKK
B60-4PP	1/2"	050 ~ 1/2"	50,35
B60-5PP	3/4"	075 ~ 3/4"	50,35
B60-6PP	1"	100 ~ 1"	50,35
B60-7PP	1 1/4"	125 ~ 1 1/4"	50,35
B60-8PP	1 1/2"	150 ~ 1 1/2"	58,45
B60-9PP	2"	200 ~ 2"	72,65
B60-10PP	2 1/2"	250 ~ 2 1/2"	145,25
B60-11PP	3"	300 ~ 3"	145,25
B60-12PP	4"	400 ~ 4"	232,25



Camlock B hun m/udv. gevind

PP (POLYPROPYLEN) - BSPP



Håndtag = AISI 304, pakning = NBR

Varenr.	BSPP	Krop	DKK
B61-4PP	1/2"	050 ~ 1/2"	116,25
B61-5PP	3/4"	075 ~ 3/4"	116,25
B61-6PP	1"	100 ~ 1"	145,25
B61-7PP	1 1/4"	125 ~ 1 1/4"	159,75
B61-8PP	1 1/2"	150 ~ 1 1/2"	173,25
B61-9PP	2"	200 ~ 2"	217,00
B61-10PP	2 1/2"	250 ~ 2 1/2"	239,25
B61-11PP	3"	300 ~ 3"	239,25
B61-12PP	4"	400 ~ 4"	578,75

Camlock C hun med studs

PP (POLYPROPYLEN)



Håndtag = AISI 304, pakning = NBR

Varenr.	Ø × dim	DKK
B62-5PP	13 × 075 ~ 3/4"	116,25
B62-5PP-1	19 × 075 ~ 3/4"	116,25
B62-6PP	25 × 100 ~ 1"	145,25
B62-6PP-1	32 × 100 ~ 1"	145,25
B62-7PP-1	30 × 125 ~ 1 1/4"	159,75
B62-7PP	32 × 125 ~ 1 1/4"	159,75
B62-8PP-1	32 × 150 ~ 1 1/2"	173,25
B62-8PP	38 × 150 ~ 1 1/2"	173,25
B62-8PP-2	40 × 150 ~ 1 1/2"	173,25
B62-9PP	50 × 200 ~ 2"	217,00
B62-9PP-1	53 × 200 ~ 2"	217,00
B62-10PP	63 × 250 ~ 2 1/2"	239,25
B62-11PP-1	63 × 300 ~ 3"	239,25
B62-11PP-3	75 × 300 ~ 3"	239,25
B62-11PP-4	78 × 300 ~ 3"	239,25
B62-12PP	105 × 400 ~ 4"	578,75

Camlock DC dæksel

PP (POLYPROPYLEN)



Håndtag = AISI 304, pakning = NBR

Varenr.	Str.	DKK
B66-4PP	050 ~ 1/2"	106,50
B66-5PP	075 ~ 3/4"	116,25
B66-6PP	100 ~ 1"	145,25
B66-7PP	125 ~ 1 1/4"	159,75
B66-8PP	150 ~ 1 1/2"	173,25
B66-9PP	200 ~ 2"	217,00
B66-10PP	250 ~ 2 1/2"	305,00
B66-11PP	300 ~ 3"	239,25
B66-12PP	400 ~ 4"	495,25

Camlock D hun m/indv. gevind

PP (POLYPROPYLEN) - BSPP



Håndtag = AISI 304, pakning = NBR

Varenr.	BSPP	Krop	DKK
B63-4PP	1/2"	050 ~ 1/2"	116,25
B63-5PP	3/4"	075 ~ 3/4"	116,25
B63-6PP	1"	100 ~ 1"	145,25
B63-7PP	1 1/4"	125 ~ 1 1/4"	159,75
B63-8PP	1 1/2"	150 ~ 1 1/2"	173,25
B63-9PP	2"	200 ~ 2"	217,00
B63-10PP	2 1/2"	250 ~ 2 1/2"	239,25
B63-11PP	3"	300 ~ 3"	239,25
B63-12PP	4"	400 ~ 4"	377,00

Camlock E han med studs

PP (POLYPROPYLEN)



Varenr.	Ø × dim	DKK
B64-5PP	13 × 075 ~ 3/4"	50,35
B64-5PP-1	19 × 075 ~ 3/4"	50,35
B64-6PP	25 × 100 ~ 1"	50,35
B64-6PP-1	32 × 100 ~ 1"	50,35
B64-7PP-1	30 × 125 ~ 1 1/4"	50,35
B64-7PP	32 × 125 ~ 1 1/4"	50,35
B64-8PP-1	32 × 150 ~ 1 1/2"	58,45
B64-8PP	38 × 150 ~ 1 1/2"	58,45
B64-8PP-2	40 × 150 ~ 1 1/2"	58,45
B64-9PP	50 × 200 ~ 2"	72,65
B64-10PP	63 × 250 ~ 2 1/2"	145,25
B64-11PP-1	63 × 300 ~ 3"	145,25
B64-11PP	75 × 300 ~ 3"	145,25
B64-12PP	105 × 400 ~ 4"	232,25

Camlock DP prop

PP (POLYPROPYLEN)



Varenr.	Str.	DKK
B67-5PP	075 ~ 3/4"	116,25
B67-6PP	100 ~ 1"	145,25
B67-7PP	125 ~ 1 1/4"	159,75
B67-8PP	150 ~ 1 1/2"	173,25
B67-9PP	200 ~ 2"	217,00
B67-10PP	250 ~ 2 1/2"	305,00
B67-11PP	300 ~ 3"	239,25
B67-12PP	400 ~ 4"	365,50

CAMLOCK KOBLINGER NYLON



Se tekst



Bredt program af Camlock koblinger i henhold til US mil-c-27487. Camlock koblinger er en sikker kobling til brug sammen med slanger og rør til mange forskellige medier som f.eks tørstoffer, kølevand, brændstof, kemikalier, kosmetik, lim, piller og meget andet. Koblingen tilsluttes nemt ved at åbne vingerne og indsætte han-delen for derefter at lukke

vingerne ved normal håndkraft.

Max tryk (21°C):

1/2"-1" = 8bar

1 1/4"-2" = 7bar

3" = 5bar

4" = 3,4bar

Camlock F han m. udv. gevind NYLON



Varenr.	BSPP	Krop	DKK
B65-4N	1/2"	050 ~ 1/2"	11,05
B65-5N	3/4"	075 ~ 3/4"	11,95
B65-6N	1"	100 ~ 1"	17,00
B65-7N	1 1/4"	125 ~ 1 1/4"	24,85
B65-8N	1 1/2"	150 ~ 1 1/2"	28,95
B65-9N	2"	200 ~ 2"	41,80
B65-10N	2 1/2"	250 ~ 2 1/2"	65,30
B65-11N	3"	300 ~ 3"	82,50
B65-12N	4"	400 ~ 4"	169,25

Camlock A han m. indv. gevind NYLON - BSPP



Varenr.	BSPP	Krop	DKK
B60-4N	1/2"	050 ~ 1/2"	11,50
B60-5N	3/4"	075 ~ 3/4"	11,50
B60-6N	1"	100 ~ 1"	13,80
B60-7N	1 1/4"	125 ~ 1 1/4"	26,60
B60-8N	1 1/2"	150 ~ 1 1/2"	27,05
B60-9N	2"	200 ~ 2"	36,70
B60-11N	3"	300 ~ 3"	63,30
B60-12N	4"	400 ~ 3"	144,50

Camlock B hun m/udv. gevind

NYLON - BSPP



Håndtag = AISI 304, pakning = NBR

Varenr.	BSPP	Krop	DKK
B61-4N	1/2"	050 ~ 1/2"	44,50
B61-5N	3/4"	075 ~ 3/4"	43,60
B61-6N	1"	100 ~ 1"	50,55
B61-7N	1 1/4"	125 ~ 1 1/4"	85,45
B61-8N	1 1/2"	150 ~ 1 1/2"	88,20
B61-9N	2"	200 ~ 2"	105,50
B61-10N	2 1/2"	250 ~ 2 1/2"	127,50
B61-11N	3"	300 ~ 3"	137,75
B61-12N	4"	400 ~ 4"	302,00

Camlock C hun med studs

NYLON



Håndtag = AISI 304, pakning = NBR

Varenr.	Ø × dim	DKK
B62-4N	15 × 050 ~ 1/2"	44,50
B62-5N	21 × 075 ~ 3/4"	44,10
B62-6N	27 × 100 ~ 1"	56,00
B62-7N	34 × 125 ~ 1 1/4"	87,10
B62-8N	40 × 150 ~ 1 1/2"	89,85
B62-9N	53 × 200 ~ 2"	110,50
B62-11N	79 × 300 ~ 3"	165,25
B62-12N	104 × 400 ~ 4"	323,75

Camlock DC dæksel

NYLON



Håndtag = AISI 304, Pakning = NBR

Varenr.	Str.	DKK
B66-4N	050 ~ 1/2"	43,95
B66-5N	075 ~ 3/4"	45,45
B66-6N	100 ~ 1"	56,50
B66-7N	125 ~ 1 1/4"	99,95
B66-8N	150 ~ 1 1/2"	103,50
B66-9N	200 ~ 2"	112,75
B66-10N	250 ~ 2 1/2"	164,00
B66-11N	300 ~ 3"	187,00
B66-12N	400 ~ 4"	303,75

Camlock D hun m/indv. gevind

NYLON - BSPP



Håndtag = AISI 304, pakning = NBR

Varenr.	BSPP	Krop	DKK
B63-4N	1/2"	050 ~ 1/2"	45,45
B63-5N	3/4"	075 ~ 3/4"	45,35
B63-6N	1"	100 ~ 1"	55,20
B63-7N	1 1/4"	125 ~ 1 1/4"	86,25
B63-8N	1 1/2"	150 ~ 1 1/2"	88,20
B63-9N	2"	200 ~ 2"	108,00
B63-10N	2 1/2"	250 ~ 2 1/2"	130,00
B63-11N	3"	300 ~ 3"	160,50
B63-12N	4"	400 ~ 4"	322,25

Camlock E han med studs

NYLON



Varenr. Ø × dim DKK

B64-4N	15 × 050 ~ 1/2"	10,10
B64-5N	21 × 075 ~ 3/4"	11,50
B64-6N	27 × 100 ~ 1"	16,15
B64-7N	34 × 125 ~ 1 1/4"	26,20
B64-8N	40 × 150 ~ 1 1/2"	28,90
B64-9N	53 × 200 ~ 2"	44,50
B64-10N	60 × 250 ~ 2 1/2"	71,00
B64-11N	79 × 300 ~ 3"	85,70
B64-12N	104 × 400 ~ 4"	162,00

Camlock DP prop

NYLON



Varenr. Str. DKK

B67-4N	050 ~ 1/2"	7,85
B67-5N	075 ~ 3/4"	7,85
B67-6N	100 ~ 1"	13,80
B67-7N	125 ~ 1 1/4"	21,05
B67-8N	150 ~ 1 1/2"	24,35
B67-9N	200 ~ 2"	29,80
B67-10N	250 ~ 2 1/2"	46,45
B67-11N	300 ~ 3"	57,85
B67-12N	400 ~ 4"	99,95

CAMLOCK TILBEHØR



Camlock pakning NBR



Varenr.	Str.	DKK
B60P-4-1	1/2"	7,00
B60P-5-1	3/4"	7,00
B60P-6-1	1"	7,00
B60P-7-1	1 1/4"	11,80
B60P-8-1	1 1/2"	11,80
B60P-9-1	2"	11,80
B60P-10-1	2 1/2"	14,70
B60P-11-1	3"	17,55
B60P-12-1	4"	22,45

Camlock pakning VITON



Varenr.	Str.	DKK
B60P-4-3	1/2"	52,65
B60P-5-3	3/4"	52,65
B60P-6-3	1"	57,35
B60P-7-3	1 1/4"	83,55
B60P-8-3	1 1/2"	109,75
B60P-9-3	2"	127,25
B60P-10-3	2 1/2"	171,00
B60P-11-3	3"	263,50
B60P-12-3	4"	394,50

Camlock pakning EPDM / PTFE (TEFLON)



Varenr.	Str.	DKK
B60P-4-5	1/2"	125,75
B60P-5-5	3/4"	125,75
B60P-6-5	1"	133,25
B60P-7-5	1 1/4"	169,50
B60P-8-5	1 1/2"	185,25
B60P-9-5	2"	209,50
B60P-10-5	2 1/2"	250,25
B60P-11-5	3"	314,00
B60P-12-5	4"	378,00

Camlock pakning EPDM



Varenr.	Str.	DKK
B60P-4-2	1/2"	9,80
B60P-5-2	3/4"	9,80
B60P-6-2	1"	9,80
B60P-7-2	1 1/4"	11,80
B60P-8-2	1 1/2"	13,85
B60P-9-2	2"	17,55
B60P-10-2	2 1/2"	21,45
B60P-11-2	3"	27,45
B60P-12-2	4"	34,00

Camlock pakning NBR / PTFE (TEFLON)



Varenr.	Str.	DKK
B60P-4-4	1/2"	120,75
B60P-5-4	3/4"	120,75
B60P-6-4	1"	128,75
B60P-7-4	1 1/4"	161,00
B60P-8-4	1 1/2"	173,25
B60P-9-4	2"	201,75
B60P-10-4	2 1/2"	241,75
B60P-11-4	3"	302,25
B60P-12-4	4"	362,25

Camlock pakning VITON / PTFE (TEFLON)



Varenr.	Str.	DKK
B60P-4-6	1/2"	166,25
B60P-5-6	3/4"	166,25
B60P-6-6	1"	178,00
B60P-7-6	1 1/4"	229,50
B60P-8-6	1 1/2"	274,25
B60P-9-6	2"	318,25
B60P-10-6	2 1/2"	390,75
B60P-11-6	3"	535,75
B60P-12-6	4"	715,50

Håndtag

AISI 304



Varenr.	dim	DKK
B60P-1-7	1/2-3/4"	11,75
B60P-2-7	1"	15,60
B60P-3-7	1 1/4-2 1/2"	20,80
B60P-4-7	3-4"	33,05

Pin

AISI 304

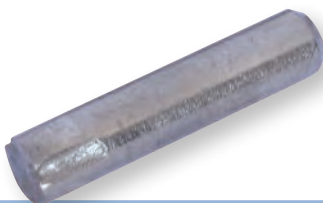

Varenr.	dim	DKK
B60P-1-8	1/2-3/4"	2,30
B60P-2-8	1"	3,06
B60P-3-8	1 1/4-2 1/2"	4,48
B60P-4-8	3-4"	9,05

Ring

AISI 304



Varenr.	Str	DKK
B60P-1-9	-	5,25

Split

AISI 304



Varenr.	Str	DKK
B60P-1-10	-	1,52

KLOKOBLINGER TIL VAND "TYPE GEKA"



316 max 40 bar, messing
max 10 bar, PA max 15 bar



-30°C til +60°C



Produceret i AISI 316, MS 58 eller PA og med standard pakning i NBR, men andre pakningstyper kan leveres, som det kan ses.

Bruges til vand, i industrien, byggeanlæg, håndværkere, landbrug samt husholdning. Brug den rustfri version i aggressive miljøer.

KOBLINGER

Klokobling m. indiv. gevind

AISI 316 - BSPP



Varenr.	BSPP	DKK
BG1-4	1/2"	172,00
BG1-5	3/4"	172,00
BG1-6	1"	172,00
BG1-7	1 1/4"	172,00
BG1-8	1 1/2"	172,00

Klokobling m. slangestuds

AISI 316



Varenr.	Ø	DKK
BG3-4	12 ~ 1/2"	194,00
BG3-5	19 ~ 3/4"	194,00
BG3-6	25 ~ 1"	194,00
BG3-7	32 ~ 1 1/4"	194,00
BG3-8	38 ~ 1 1/2"	194,00

Klokobling std. pakning

NBR



Varenr.	Type	DKK
BG5	NBR	3,11

Klokobling m. udv. gevind

AISI 316 - BSPT



Varenr.	BSPP	DKK
BG2-4	1/2"	172,00
BG2-5	3/4"	172,00
BG2-6	1"	172,00
BG2-7	1 1/4"	172,00
BG2-8	1 1/2"	172,00

Klokobling dæksel

AISI 316



Varenr.	Str.	DKK
BG4	-	110,75

Klokobling pakning

VITON



Varenr.	Type	DKK
BG6	VITON	131,75

Klokobling m. indv. gevind

MESSING - BSPP

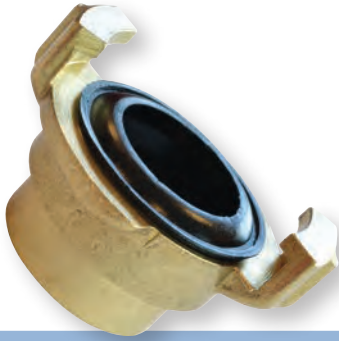

Varenr.	BSPP	DKK
EG1-2	1/4"	36,15
EG1-3	3/8"	31,45
EG1-4	1/2"	30,05
EG1-5	3/4"	29,25
EG1-6	1"	29,25
EG1-7	1 1/4"	47,50
EG1-8	1 1/2"	52,70

Klokobling dæksel

MESSING



Varenr.	Str.	DKK
EG4	-	46,75

Klokobling m. slangestuds

MESSING



Svivel		
Varenr.	Ø	DKK
EG8-3	10 ~ 3/8"	33,85
EG8-4	13 ~ 1/2"	162,75
EG8-5	19 ~ 3/4"	152,75
EG8-6	25 ~ 1"	211,75
EG8-7	32 ~ 1 1/4"	258,00
EG8-8	38 ~ 1 1/2"	78,10

Klokobling m. udv. gevind

MESSING - BSPT



Varenr.	BSPP	DKK
EG2-2	1/4"	31,65
EG2-3	3/8"	30,60
EG2-4	1/2"	27,60
EG2-5	3/4"	28,20
EG2-6	1"	30,30
EG2-7	1 1/4"	37,90
EG2-8	1 1/2"	52,70

Klokobling Y-stk til 1" slange

MESSING



Varenr.	Str.	DKK
EG6-1	-	187,50

Klokobling m. justerbar dyse

MESSING



Varenr.	Str.	DKK
EG7-4	1/2"	168,25
EG7-5	3/4"	200,00
EG7-6	1"	286,25

Klokobling m. slangestuds 90°

MESSING



Svivel		
Varenr.	Ø	DKK
EG9-4	13 ~ 1/2"	201,00
EG9-5	19 ~ 3/4"	162,75
EG9-6	25 ~ 1"	323,75

Klokobling m. slangestuds

MESSING



Varenr.	Ø	DKK
EG3-3	10 ~ 3/8"	30,60
EG3-4	13 ~ 1/2"	28,95
EG3-5	19 ~ 3/4"	30,30
EG3-6	25 ~ 1"	39,15
EG3-7	32 ~ 1 1/4"	50,00
EG3-8	38 ~ 1 1/2"	71,25

Klokobling std. pakning

NBR



Varenr.	Type	DKK
BG5	NBR	3,11

Klokobling pakning

EPDM



Varenr.	Type	DKK
EG5	EPDM	15,15

Geka klokobling med indv. gevind

PA (POLYAMID) - BSPP



Varenr.	BSPP	DKK
AG1-4	1/2"	98,30
AG1-5	3/4"	98,30
AG1-6	1"	99,70
AG1-7	1 1/4"	126,50
AG1-8	1 1/2"	131,75

Geka klokobling med slange-studs

PA (POLYAMID)



Varenr.	Ø	DKK
AG3-3	10 ~ 3/8"	81,40
AG3-4	13 ~ 1/2"	86,05
AG3-5	19 ~ 3/4"	86,05
AG3-6	25 ~ 1"	90,65
AG3-7	32 ~ 1 1/4"	112,50

Geka klokobling med udv. gevind

PA (POLYAMID) - BSPP



Varenr.	BSPP	DKK
AG2-4	1/2"	86,05
AG2-5	3/4"	86,05
AG2-6	1"	89,25
AG2-7	1 1/4"	98,30
AG2-8	1 1/2"	125,00

Geka klokobling dæksel

PA (POLYAMID)



Varenr.	Str.	DKK
AG4	-	86,20

Klokobling std. pakning

NBR



Varenr.	Type	DKK
BG5	NBR	3,11

Klokobling pakning

EPDM



Varenr.	Type	DKK
EG5	EPDM	15,15

KLOKOBLINGER TIL LUFT



Arbejdstryk 10 bar.
Sprængningstryk 17 bar



Europæiske klokoblinger er fremstillet af duktilt støbejern og derefter el-galvaniseret for beskyttelse. De har et universelt låsehoved og fås med indvendigt gevind, udvendigt gevind eller med slangestuds. De leveres med en sort gummi pakning. Anvendes i hele Europa.

Anvendelse: For fleksible trykluftledninger i byggesektoren og industriel brug.

NB! Denne type kobling må ALDRIG frakobles med tryk på systemet.

Klokobling m. indv. gevind

DULTILJERN - BSPP

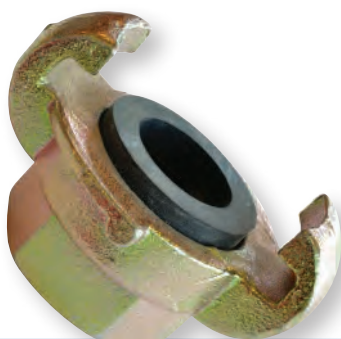

Varenr.	BSPP	DKK
K1-2	1/4"	33,25
K1-3	3/8"	33,25
K1-4	1/2"	33,75
K1-5	3/4"	37,30
K1-6	1"	40,40
K1-7	1 1/4"	52,40

Klokobling m. slangestuds

DULTILJERN



Varenr.	Ø	DKK
K3-2	1/4"	35,85
K3-3	3/8"	35,85
K3-4	1/2"	36,35
K3-5	3/4"	40,40
K3-6	1"	47,90
K3-7	1 1/4"	55,00

Klokobling slutmuffe

DULTILJERN



Varenr.	Str.	DKK
K7	-	32,75

Klokobling m. udv. gevind

DULTILJERN - BSPP



Varenr.	BSPP	DKK
K2-2	1/4"	36,35
K2-3	3/8"	36,35
K2-4	1/2"	39,30
K2-5	3/4"	40,40
K2-6	1"	47,40
K2-7	1 1/4"	57,10

Klokobling m. slangestuds

DUKTILJERN



Med krave, bruges sammen med K6		
Varenr.	Ø	DKK
K4-4	1/2"	40,40
K4-5	3/4"	42,35
K4-6	1"	49,95
K4-7	1 1/4"	60,90

Klokobling pakning



Varenr.	Type	DKK
K5-1	NBR	3,10
K5-2	VITON	30,30
K5-3	TEFLON	55,45

Klokobling clamp

DULTILJERN



Varenr.	Dim	DKK
K6-1	1/2"	67,20
K6-2	3/4"	71,80
K6-3	1"	92,25
K6-4	1 1/4"	105,25

NiTO KOBLINGER TIL VAND



25 bar



-30°C til +80°C



NiTO er produceret med meget høj kvalitet og er et program med fantastisk stabilitet.

KOBLINGER

NiTO kobling m. udv. gevind

MESSING - BSPP



Varenr.	BSPP × NiTO	DKK
744809004	1/2" × 1/2"	137,00

NiTO kobling m. slangestuds

MESSING



Varenr.	Ø × NiTO	DKK
744808004	1/2" × 1/2"	110,75

NiTO nippel m. indv. gevind

MESSING - BSPP



Varenr.	MM × NiTO	DKK
744816022	M22*1 × 1/2"	43,40

NiTO kobling m. udv. gevind

MESSING - BSPP



Varenr.	BSPP × NiTO	DKK
744809036	3/4" × 1/2"	137,00

NiTO kobling m. slangestuds

MESSING



Varenr.	Ø × NiTO	DKK
744808006	3/4" × 1/2"	126,50

NiTO nippel m. indv. gevind

MESSING - BSPP



Varenr.	BSPP × NiTO	DKK
744816006	3/4" × 1/2"	62,30

NiTO kobling m. indv. gevind

MESSING - BSPP



Varenr.	BSPP × NiTO	DKK
744810004	1/2" × 1/2"	113,25

NiTO nippel m. udv. gevind

MESSING - BSPP



Varenr.	BSPP × NiTO	DKK
744818004	1/2" × 1/2"	43,10

NiTO nippel m. slangestuds

MESSING



Varenr.	Ø × NiTO	DKK
744812003	3/8" × 1/2"	49,85

NiTO kobling m. multigevind

MESSING - BSPP



Varenr.	BSPP × NiTO	DKK
744811006	Multi × 1/2"	165,00

Multi = 1/2"+3/4"+M22*1

NiTO nippel m. indv. gevind

MESSING - BSPP



Varenr.	BSPP × NiTO	DKK
744816004	1/2" × 1/2"	49,85

NiTO nippel m. slangestuds

MESSING



Varenr.	Ø × NiTO	DKK
744812004	1/2" × 1/2"	45,55

NiTO nippel m. slangestuds
MESSING



Varenr.	Ø × NiTO	DKK
744812024	3/4" × 1/2"	54,85

NiTO kobling m. indiv. gevind
MESSING - BSPP



Varenr.	BSPP × NiTO	DKK
744810006	3/4" × 1/2"	127,50
744810036	3/4" × 3/4"	125,50

NiTO kobling m. slangestuds
MESSING



Varenr.	Ø × NiTO	DKK
744808036	3/4" × 3/4"	164,75

NiTO nippel m. udv. gevind
MESSING - BSPP



Varenr.	BSPP × NiTO	DKK
744818036	3/4" × 3/4"	73,15

NiTO nippel m. udv. gevind
MESSING / NBR - BSPP



Varenr.	BSPP × NiTO	DKK
744818056	3/4" × 3/4"	80,55

NiTO nippel m. indiv. gevind
MESSING - BSPP



Varenr.	BSPP × NiTO	DKK
744816034	1/2" × 3/4"	68,50

NiTO nippel m. indiv. gevind
MESSING - BSPP



Varenr.	BSPP × NiTO	DKK
744816036	3/4" × 3/4"	84,10

NiTO nippel m. slangestuds
MESSING



Varenr.	Ø × NiTO	DKK
744812034	1/2" × 3/4"	62,80

NiTO nippel m. slangestuds
MESSING



Varenr.	Ø × NiTO	DKK
744812036	3/4" × 3/4"	56,25

NiTO 1/2" startsæt
1/2" BSPP



NiTO 1" pistol med 1/2" NiTO nippel tilslutning og 1/2" NiTO kobling afgang + 1/2" NiTO kobling med slangestuds + 1/2" NiTO nippel med dyse + spændebånd

Varenr.	Ø	DKK
744850050	-	649,25

Industripistol
MESSING - 1/2" BSPP



Industripistol lavet af messing indstøbt i EPDM. Uden bøjle. Ikke-isoleret aftrækker. Max 24 bar, max 95°C.

Varenr.	BSPP	Farve	DKK
744841324	1/2"	BLÅ	773,00
744841324-2	1/2"	SORT	773,00
744841324-3	1/2"	RØD	773,00
744841324-4	1/2"	GRØN	773,00
744841324-5	1/2"	GUL	773,00
744841324-6	1/2"	HVID	773,00

NiTO adapter
MESSING - BSPP×MM



Varenr.	BSPP × mm	DKK
744950004	1/2" × M22*1	42,55

NiTO adapter
MESSING - BSPP×MM

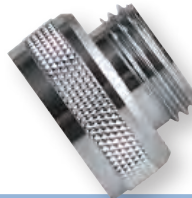

Varenr.	BSPP × mm	DKK
744950006	3/4" × M22*1	50,60

NiTO adapter
MESSING - MM×BSPP

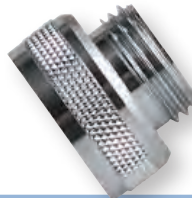

Varenr.	mm × BSPP	DKK
744950022	M22*1 × 1/2"	42,00

GEKA LYNKOBLINGER TIL VAND



1-35 bar



-20°C til +60°C



GEKA er tysk kvalitet og føles også sådan, med stor tyngde.

Her er et udvalg, der især er beregnet på at blive sat sammen med haveslanger.

KOBLINGER

Geka kobling

MESSING



Varenr.	Slange dim	DKK
MG1-4	1/2" (12,5/16,5)	116,25
MG1-5	3/4" (19/24,5)	135,00

Geka kobling m. indv. gevind

MESSING - BSPP



Varenr.	BSPP	DKK
MG4-4	1/2" (12,5/16,5)	47,25
MG4-5	3/4" (19/24,5)	52,45

Geka kobling Y-stk

MESSING



Varenr.	-	DKK
MG7	-	128,00

Geka kobling m. vandstop

MESSING



Varenr.	Slange dim	DKK
MG2-4	1/2" (12,5/16,5)	132,50
MG2-5	3/4" (19/24,5)	158,75

Geka kobling m. udv. gevind

MESSING - BSPP



Varenr.	BSPP	DKK
MG5-4	1/2" (12,5/16,5)	47,25
MG5-5	3/4" (19/24,5)	52,45

Narcis ATH slange

PVC (POLYVINYLCHLORID)



Suveræn vandslange, blød og føjelig og strikket, så den modvirker at blive vredet. Sort indvendig. UV bestandig gul PVC yderst.

Varenr.	ø/Ø	bar 20°C	L	DKK
JA2-1216	12,5/16,5	10	25m	229,00
JA2-1519	15/19,5	10	25m	500,75
JA2-1924	19/24,5	10	25m	602,00
JA2-2531	25/31,5	10	25m	844,75

Sælges kun i fuld længde.

Geka union

MESSING



Varenr.	Slange dim	DKK
MG3-4	1/2" (12,5/16,5)	92,25
MG3-5	3/4" (19/24,5)	156,50

Geka kobling

MESSING



Varenr.	-	DKK
MG6	-	56,75

SLANGESTUDSKOBLINGER MESSING



For max tryk: se slangespecifikationer



For temperatur: se slangespecifikationer



Denne serie af slangestudskoblinger i messing er beregnet til større slanger fra 15mm indvendig mål til 60mm indvendig mål.

Kobling nippel/studs

MESSING - BSPT



Varenr.	Ø × BSPT	DKK
ET1-1	15 × 1/2"	75,65
ET1-2	20 × 3/4"	125,75
ET1-3	25 × 1"	156,25
ET1-4	30 × 1"	178,00
ET1-5	30 × 1 1/4"	188,50
ET1-6	35 × 1 1/4"	242,75
ET1-7	40 × 1 1/2"	269,50
ET1-8	50 × 2"	431,75
ET1-9	60 × 2"	864,50
ET1-10	60 × 2 1/2"	908,50

Afløb m. slutmuffe

MESSING - BSPP



Varenr.	BSPP	Ext. dim	DKK
ET5-1	1/2"	22	89,00
ET5-2	3/4"	27	125,75
ET5-3	1"	34	136,00
ET5-4	1 1/4"	43	248,25

Kobling 90° nip/studs

MESSING - BSPT



Varenr.	Ø × BSPP	DKK
ET4-1	15 × 1/2"	102,00
ET4-2	20 × 3/4"	141,75
ET4-3	25 × 1"	186,50
ET4-4	30 × 1"	218,25
ET4-5	30 × 1 1/4"	229,50
ET4-6	35 × 1 1/4"	292,75
ET4-7	40 × 1 1/2"	343,00
ET4-8	50 × 2"	542,50
ET4-9	60 × 2"	1064,00
ET4-10	60 × 2 1/2"	1108,50

Kobling studs/studs

MESSING



Varenr.	Ø	DKK
ET2-1	13	59,00
ET2-2	15	72,10
ET2-3	18	73,70
ET2-4	20	117,75
ET2-5	25	158,50
ET2-6	30	178,00
ET2-7	35	207,00
ET2-8	40	272,75
ET2-9	45	354,75
ET2-10	50	413,50

Kobling skotgennemføring

MESSING - BSPP



Varenr.	BSPP	Ext. dim	DKK
ET3-1	3/8"	18	67,75
ET3-2	1/2"	22	73,15
ET3-3	3/4"	27	97,20
ET3-4	1"	34	133,25
ET3-5	1 1/4"	43	217,00
ET3-6	1 1/2"	49	260,00
ET3-7	2"	61	405,75

TW KOBLINGER



Max 15 bar



DIN 28450



Koblinger for tankvogne og lignende applikationer. Leveres både i rustfri syrefast stål AISI 316 og messing. Pakninger kan fås til ethvert behov.

KOBLINGER

SANDSTØBNING AF RUSTFRI EMNER

En ældgammel, simpel støbemetode, med en høj grad af sikkerhed for et godt resultat hver gang.



1. Først støbes voksforme, af samme form som det færdige emne, i en støbeform.



2. Voksformene sorteres for fejl og finpudses.



3. Voksformene hænges på "juletræer" og dyppes først i væske og derefter i sand. 7 gange i alt med tørring i mellem.



4. Sand/voks formen brændes, hvorved voksen smelter væk og sandformen hærder og bliver klar til støbning.



5. Sandformen fyldes med flydende rustfri syrefast stål.



6. Sandet bankes af de rustfri emner efter afkøling.



7. Emnerne finpudses og gennemses for fejl og mangler.

TW kobling MK indiv. gevind

AISI 316 / NBR - BSPP



Varenr.	Str.	DKK
BTW1-9	2"	628,00
BTW1-11	3"	1108,50
BTW1-12	4"	1899,50

TW kobling VB prop

AISI 316



Varenr.	Str.	DKK
BTW4-9	2"	183,25
BTW4-11	3"	304,75
BTW4-12	4"	1698,50

TW kobling MB dæksel

MESSING / NBR



Varenr.	Str.	DKK
ETW3-9	2"	199,50
ETW3-11	3"	505,50

TW kobling VK indiv. gevind

AISI 316 / NBR - BSPP



Varenr.	Str.	DKK
BTW2-9	2"	244,25
BTW2-11	3"	492,50
BTW2-12	4"	714,25

TW kobling MK indiv. gevind

MESSING / NBR - BSPP

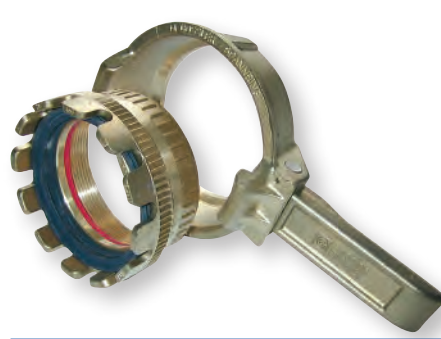

Varenr.	Str.	DKK
ETW1-9	2"	455,75
ETW1-11	3"	1097,00
ETW1-12	4"	2038,50

TW kobling VB prop

MESSING



Varenr.	Str.	DKK
ETW4-9	2"	135,00
ETW4-11	3"	446,00

TW kobling MB dæksel

AISI 316 / NBR



Varenr.	Str.	DKK
BTW3-9	2"	227,50
BTW3-11	3"	453,75
BTW3-12	4"	799,50

TW kobling VK indiv. gevind

MESSING / NBR - BSPP



Varenr.	Str.	DKK
ETW2-9	2"	194,75
ETW2-11	3"	440,50
ETW2-12	4"	644,50

TW kobling MB dæksel

ALUMINIUM



Varenr.	Str.	DKK
ATW3-9	2"	95,05
ATW3-11	3"	177,50
ATW3-12	4"	371,50

TW kobling VB prop

ALUMINIUM



Varenr.	Str.	DKK
ATW4-9	2"	70,15
ATW4-11	3"	136,25
ATW4-12	4"	293,00

TW kobling VB prop

PP (POLYPROPYLEN)



Varenr.	Str.	DKK
PTW4-9	2"	29,60

TW pakning

HYPALON



Til hunpart udv.

Varenr.	Str.	DKK
ETW5-9	2"	15,00
ETW5-11	3"	29,05
ETW5-12	4"	29,05

TW pakning

NBR



Til hunpart udv.

Varenr.	Str.	DKK
ETW6-9	2"	12,85
ETW6-11	3"	23,65
ETW6-12	4"	26,50

TW pakning

NBR



Til hanpart/hunpart indiv.

Varenr.	Str.	DKK
ETW8-9	2"	14,85
ETW8-11	3"	18,30
ETW8-12	4"	51,25

TW pakning

PU (POLYURETHAN)



Til hanpart/hunpart indiv.

Varenr.	Str.	DKK
ETW10-9	2"	11,50
ETW10-11	3"	23,05
ETW10-12	4"	38,55

TW pakning

PTFE (TEFLON)



Til hanpart/hunpart indiv.

Varenr.	Str.	DKK
ETW11-9	2"	12,20
ETW11-11	3"	16,60
ETW11-12	4"	33,50

TW pakning

HYPALON



Til dæksel

Varenr.	Str.	DKK
ETW7-9	2"	14,85
ETW7-11	3"	26,50
ETW7-12	4"	29,05

TW pakning

NBR



Til dæksel

Varenr.	Str.	DKK
ETW9-9	2"	18,55
ETW9-11	3"	63,35
ETW9-12	4"	26,50

TW kæde

AISI 316



Varenr.	Str.	DKK
ETW12	-	23,90

STORZ KOBLINGER



Storz koblinger, også kaldet brand-koblinger, anvendes til hurtig og enkel sammenkobling af slanger. De er lette at håndtere og findes i forskellige typer. Koblingerne bruges primært til transport af væsker, luft, pulver og granulat. Alle koblinger leveres med suge- og trykpakning.

Storz kobling m. udv. gevind ALUMINIUM - BSPT



Varenr.	BSPP	Type	Ka	DKK
MST1-6	1"	D	31	152,00
MST1-7	1 1/4"		51	α
MST1-8	1 1/2"		51	297,75
MST1-8-1	1 3/4"		58	71,55
MST1-9	2"	C	66	81,40
MST1-10	2 1/2"		82	210,25
MST1-11	3"	B	89	218,75
MST1-12	4"	A	133	272,75
MST1-13	5"		148	299,75

Ka = kloafstand

Storz kobling m. indv. gevind ALUMINIUM - BSPP



Varenr.	BSPP	Type	Ka	DKK
MST2-5	3/4"	D	31	243,50
MST2-6	1"	D	31	81,65
MST2-7	1 1/4"		51	228,75
MST2-8	1 1/2"		51	71,00
MST2-8-1	1 3/4"		58	78,35
MST2-9	2"	C	66	93,10
MST2-10	2 1/2"		82	128,75
MST2-11	3"	B	89	128,75
MST2-12	4"	A	133	283,25
MST2-13	5"		148	865,25

Ka = kloafstand

Storz kobling m. slangestuds ALUMINIUM



Varenr.	Ø	Type	Ka	DKK
MST3-5	19 ~ 3/4"	D	31	115,50
MST3-6	25 ~ 1"	D	31	103,75
MST3-7	38 ~ 1 1/4"		51	α
MST3-8	38 ~ 1 1/2"		51	70,15
MST3-8-1	42 ~ 1 3/4"		58	73,15
MST3-9	52 ~ 2"	C	66	82,50
MST3-10	63 ~ 2 1/2"		82	105,50
MST3-11	75 ~ 3"	B	89	141,75
MST3-12	101 ~ 4"	A	133	579,25
MST3-13	127 ~ 5"		148	483,50

Ka = kloafstand



Storz kobling reduktion

ALUMINIUM



Varenr.	Str.	Ka	DKK
MST5-1	1½" × 2"	51 × 66	52,20
MST5-2	2" × 2½"	66 × 82	157,50
MST5-3	1½" × 3"	51 × 89	162,50
MST5-4	2" × 3"	66 × 89	512,25

Ka = kloafstand

Storz pakning

EPDM



Til kobling

Varenr.	Str.	Type	DKK
MST6-5	¾"		3,82
MST6-6	1"	D	3,82
MST6-7	1¼"		-
MST6-8	1½"		6,35
MST6-8-1	1¾"		6,35
MST6-9	2"	C	8,10
MST6-10	2½"		12,40
MST6-11	3"	B	14,45
MST6-12	4"	A	23,10
MST6-13	5"		24,75

Storz kobling slutmuffe

ALUMINIUM / KÆDE = STÅL



Varenr.	Str.	Type	Ka	DKK
MST4-6	1"	D	31	68,25
MST4-7	1¼"	D	31	α
MST4-8	1½"	D	51	88,45
MST4-9	2"	C	66	123,25
MST4-10	2½"		82	136,75
MST4-11	3"	B	89	171,00
MST4-12	4"	A	133	626,25
MST4-13	5"		148	491,00

Ka = kloafstand

Storz pakning hvid



Til indiv. gevind

Varenr.	Str.	Type	DKK
MST8-5	¾"		1,85
MST8-6	1"	D	1,85
MST8-7	1¼"		-
MST8-8	1½"		2,98
MST8-8-1	1¾"		2,98
MST8-9	2"	C	3,45
MST8-10	2½"		5,10
MST8-11	3"	B	6,35
MST8-12	4"	A	12,70
MST8-13	5"		22,00

Storz kobling nøgle



Varenr.	Str.	DKK
MST7-2	1" - 2"	81,40
MST7-3	2½" - 5"	126,50



539

SLANGEKOBLINGER



EN 14420 / DIN 2817



DIN 2817 slangekoblinger leveres med udvendig gevind og Indvendig med løs omløber, i såvel messing som rustfri syrefast stål.

Klembakkerne er inkl. bolte.

Til serien hører DIN 2817 klembakker, der leveres i aluminium samt rustfri syrefast stål.

Kobling slangennippel

MESSING - BSPT



Varenr.	BSPP	Ø	DKK
LM20-4	1/2"	13.2	50,25
LM20-5	3/4"	19.2	80,55
LM20-6	1"	25.2	96,65
LM20-7	1 1/4"	32.2	134,75
LM20-8	1 1/2"	38.2	187,50
LM20-9	2"	50.2	348,75
LM20-10	2 1/2"	63.2	375,50
LM20-11	3"	75.2	509,00
LM20-12	4"	100.4	856,50

Kobling slangennippel

AISI 316 - BSPT



Varenr.	BSPP	Ø	DKK
LB20-4	1/2"	13.2	107,00
LB20-5	3/4"	19.2	107,50
LB20-6	1"	25.2	134,75
LB20-7	1 1/4"	32.2	161,00
LB20-8	1 1/2"	38.2	214,00
LB20-9	2"	50.2	375,50
LB20-10	2 1/2"	63.2	466,00
LB20-11	3"	75.2	642,50
LB20-12	4"	100.4	1070,25

Kobling klembakker m. bolte

ALUMINIUM



Varenr.	Str.	Ø min/max	DKK
LA21-1	1/2"	22-24	109,50
LA21-2	3/4"	30-33	121,50
LA21-3	1"	36-39	132,00
LA21-4	1 1/4"	43-46	145,25
LA21-5	1 1/2"	50-52	159,25
LA21-6	2"	64-67	268,25
LA21-7	2 1/2"	78-82	326,00
LA21-8	3"	78-82	387,75
LA21-10	4"	78-82	856,00

Kobling slangennippel

MESSING - BSPT



Løs omløber			
Varenr.	BSPP	Ø	DKK
LM22-4	1/2"	13.2	59,00
LM22-5	3/4"	19.2	95,55
LM22-6	1"	25.2	121,50
LM22-7	1 1/4"	32.2	197,75
LM22-8	1 1/2"	38.2	241,50
LM22-9	2"	50.2	330,00
LM22-10	2 1/2"	63.2	549,25
LM22-11	3"	75.2	863,75
LM22-12	4"	100.4	1565,75

Kobling slangennippel

AISI 316 - BSPT



Løs omløber			
Varenr.	BSPP	Ø	DKK
LB22-4	1/2"	13.2	121,50
LB22-5	3/4"	19.2	150,75
LB22-6	1"	25.2	191,25
LB22-7	1 1/4"	32.2	264,25
LB22-8	1 1/2"	38.2	344,25
LB22-9	2"	50.2	443,25
LB22-10	2 1/2"	63.2	688,00
LB22-11	3"	75.2	941,25
LB22-12	4"	100.4	1578,00

Kobling klembakker m. bolte

AISI 316



Varenr.	Str.	Ø min/max	DKK
LB21-1	1/2"	22-24	157,50
LB21-2	3/4"	30-33	196,25
LB21-3	1"	36-39	214,00
LB21-4	1 1/4"	43-46	236,75
LB21-5	1 1/2"	50-52	282,75
LB21-6	2"	64-67	426,50
LB21-7	2 1/2"	78-82	651,00
LB21-8	3"	89-93	733,00
LB21-10	4"	114-119	1711,00

KOBLINGER TYPE "BAUER"



"Bauer" koblinger udmærker sig ved at være hurtige og lette at tilkoble og frakoble. Dette giver stor flexibilitet i installationen, selv på vanskelige steder.

KOBLINGER

Bauer kobling

AISI 304 / GREB = STÅL

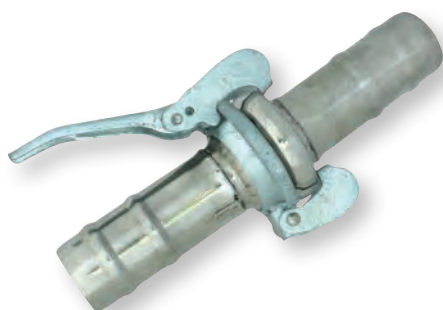

Varenr.	Str.	L mm	DKK
LB1-9	53,5 ~ 2"	312	919,00
LB1-11	79 ~ 3"	367	1379,25
LB1-12	103,5 ~ 4"	552	2637,00
LB1-14	154 ~ 6"	594	4635,00

Bauer kobling

GALVANISERET

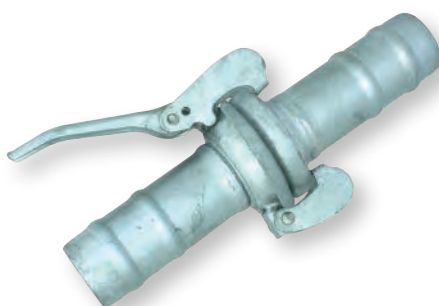

Varenr.	Str.	L mm	DKK
LG1-9	53,5 ~ 2"	312	307,75
LG1-11	79 ~ 3"	367	460,75
LG1-12	103,5 ~ 4"	552	878,50
LG1-14	154 ~ 6"	594	1545,00

Amazona SE slange

PVC (POLYVINYLCHLORID)



Meget fleksibel PVC slange med blød PVC spiral. Anvendes til sugning af væsker, f.eks. ved afløb samt forurenede væsker.

-20° til +60°C

Varenr.	ø/Ø	bar 20°C	L	DKK / m
J30-20	20/27	6	50m	45,30
J30-25	25/32,4	6	50m	50,10
J30-30	30/37,8	6	50m	60,05
J30-32	32/40	6	50m	62,30
J30-35	35/43,4	6	50m	67,20
J30-38	38/46,6	6	50m	71,00
J30-40	40/48,8	6	50m	78,90
J30-45	45/54	5,5	50m	94,50
J30-50	50/59,8	5	50m	99,35
j30-60	60/70	5	50m	123,75
J30-63	63/73,4	4,5	50m	130,25
J30-70	70/80,8	4,5	50m	159,00
J30-76	76/87	4,5	50m	165,00
J30-80	80/92	4	50m	182,00
J30-90	90/102,6	4	50m	222,00
J30-100	102/115,2	3,5	50m	235,75
J30-110	110/123,8	3,5	30m	303,75
J30-125	125/140	3	20m	324,75
J30-150	150/167,6	2	20m	403,75
J30-200	200/224	1,5	10m	772,25

Afskæres mellem 1 - 5m, ellers fuld længde.

O-ring/pakning til Bauer

SBR



Varenr.	Dim	DKK
LB4-9	2"	7,20
LB4-11	3"	27,70
LB4-12	4"	29,10
LB4-14	6"	58,20

Slangenippel

AISI 304 - BSPP



Varenr.	Ø × BSPP	L mm	DKK
LB2-4	13,5 × 1/2"	75	50,65
LB2-5	19,7 × 3/4"	77	77,25
LB2-6	26,0 × 1"	81	103,00
LB2-7	32,3 × 1 1/4"	88	120,75
LB2-8	38,7 × 1 1/2"	98	188,50
LB2-9	51,4 × 2"	108	260,00
LB2-10	64,7 × 2 1/2"	133	400,75
LB2-11	77,5 × 3"	143	528,00
LB2-12	102,8 × 4"	168	917,50
LB2-13	128,3 × 5"	233	1827,25
LB2-14	153,6 × 6"	252	UDGÅET
LB2-16	204,5 × 8"	288	3898,75

Slangesamler

AISI 304



Varenr.	dim	L mm	DKK
LB3-4	13,5 ~ 1/2"	79,8	105,25
LB3-5	19,7 ~ 3/4"	99,8	134,75
LB3-6	26,0 ~ 1"	99,8	202,00
LB3-7	32,3 ~ 1 1/4"	99,8	268,50
LB3-8	38,7 ~ 1 1/2"	99,8	356,00
LB3-9	51,4 ~ 2"	111	511,00
LB3-10	64,7 ~ 2 1/2"	136	926,25
LB3-11	77,5 ~ 3"	146	1189,75
LB3-12	102,8 ~ 4"	171	1998,25
LB3-13	128,3 ~ 5"	236	3485,75
LB3-14	153,6 ~ 6"	255	4465,25
LB3-16	204,5 ~ 8"	291	8631,50

Slangenippel

GALVANISERET - BSPP



Varenr.	Ø × BSPP	L mm	DKK
LG2-4	13,5 × 1/2"	75	21,45
LG2-5	19,7 × 3/4"	77	21,95
LG2-6	26,0 × 1"	81	27,15
LG2-7	32,3 × 1 1/4"	88	30,40
LG2-8	38,7 × 1 1/2"	98	38,30
LG2-9	51,4 × 2"	108	128,25
LG2-10	64,7 × 2 1/2"	133	133,25
LG2-11	77,5 × 3"	143	149,25
LG2-12	102,8 × 4"	168	223,75
LG2-13	128,3 × 5"	233	501,50
LG2-14	153,6 × 6"	252	691,50
LG2-16	204,5 × 8"	288	883,75





Slangesamler

GALVANISERET

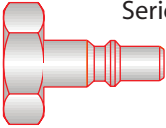
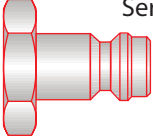
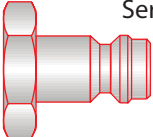
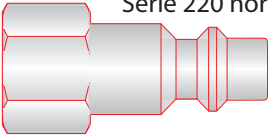
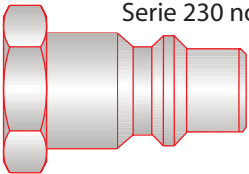
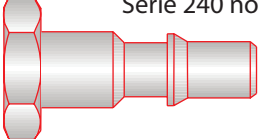
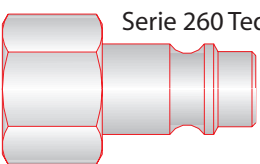
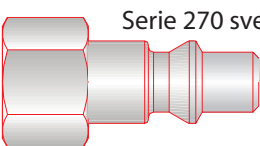

Varenr.	dim	L mm	DKK
LG3-4	13,5 ~ 1/2"	79,8	10,15
LG3-5	19,7 ~ 3/4"	99,8	16,10
LG3-6	26,0 ~ 1"	99,8	20,45
LG3-7	32,3 ~ 1 1/4"	99,8	29,00
LG3-8	38,7 ~ 1 1/2"	99,8	35,75
LG3-9	51,4 ~ 2"	111	44,45
LG3-10	64,7 ~ 2 1/2"	136	75,65
LG3-11	77,5 ~ 3"	146	105,25
LG3-12	102,8 ~ 4"	171	190,50
LG3-13	128,3 ~ 5"	236	297,00
LG3-14	153,6 ~ 6"	255	378,00
LG3-16	204,5 ~ 8"	291	658,00

PROFIL SKALA 1:1

	Serie 200 mini	$\text{\textcircled{DN}}$ 2,5 mm	Kompatibilitet: Norma UNI ISO 6150 A-6
	Serie 210 mignon	$\text{\textcircled{DN}}$ 5 mm	Kompatibilitet: Mignon, Rectus 21, Rectus 90, Camozzi 5150, Asturo 11400, Legris 21.
	Serie 210 mignon, dobbelt	$\text{\textcircled{DN}}$ 5 mm	Kompatibilitet: Mignon, Rectus 21, Rectus 90, Camozzi 5150, Asturo 11400, Legris 21.
	Serie 220 norma	$\text{\textcircled{DN}}$ 5,5 mm	Kompatibilitet: Norma UNI ISO 6150 B-12, Rectus 23, Rectus 24, US-MIL SPEC C-4109, Hansen 3000, Gromelle 600, Parker 30 1/4, CEJN 310, JWL 521/531, Nordgren Dynaquip DC3.
	Serie 230 norma	$\text{\textcircled{DN}}$ 9 mm	Kompatibilitet: Norma UNI ISO 6150 B-15, Rectus 30, US-MIL SPEC C-4109, Hansen 4000, Gromelle 90, ARO, Parker 30 3/8.
	Serie 240 norma	$\text{\textcircled{DN}}$ 5,5 mm	Kompatibilitet: Norma UNI ISO 6150 C-10, Rectus 18, Staubli RCS-RBE 6, Oetiker ISO standard DP 6150, CEJN 291, Gromelle, Legris 18.
	Serie 260 Tedesco	$\text{\textcircled{DN}}$ 7,5 mm	Kompatibilitet: Standard Tedesco, Rectus 25/26, CEJN 320, Camozzi 5180, JWL 520/530, Festo KD serie, TST, Asturo 11140, Legris 25/26, Prevost ERC07.
	Serie 270 svensk	$\text{\textcircled{DN}}$ 5,5 mm	Kompatibilitet: Standard Svedese, Rectus 14, Rectus 22, CEJN 300, ARO 210, Parker 50, Orion 44510, JWL 522/523, Asturo 11110, Legris 14/24, Prevost ARM06.
	Serie 410-510		Kompatibilitet: Staubli
	Serie 660 europæisk	$\text{\textcircled{DN}}$ 7,5 mm	Kompatibilitet: Standard Tedesco, Rectus 25/26, CEJN 320, Camozzi 5180, JWL 520/530, Festo KD serie, TST, Asturo 11140, Legris 25/26, Prevost ERC07.
	Serie 670 svensk	$\text{\textcircled{DN}}$ 5,5 mm	Kompatibilitet: Standard Svedese, Rectus 14, Rectus 22, CEJN 300, ARO 210, Parker 50, Orion 44510, JWL 522/523, Asturo 11110, Legris 14/24, Prevost ARM06.

MATERIALEOVERSIGT

SERIE 200 - 270

1. Forniklet messing krop
2. Fjeder, AISI 302
3. Forniklet messing lukkestyrer
- 4+5+6. NBR 70 O-ring
7. Forniklet messing koblingring
8. Omløber, AISI 302
9. Kugle, AISI 420
10. Forniklet messing udløserring
11. Forniklet messing krop
12. Forniklet messing prop

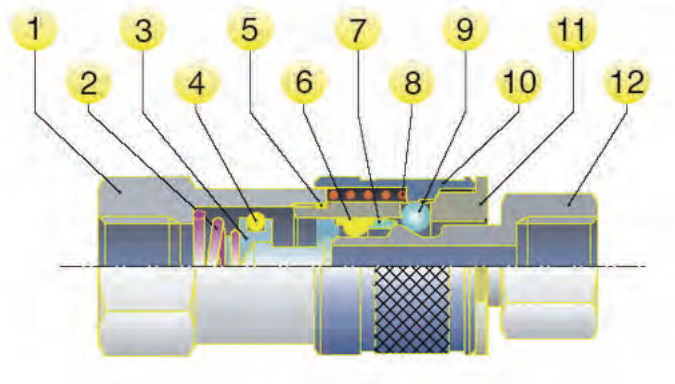

SERIE 410 - 510

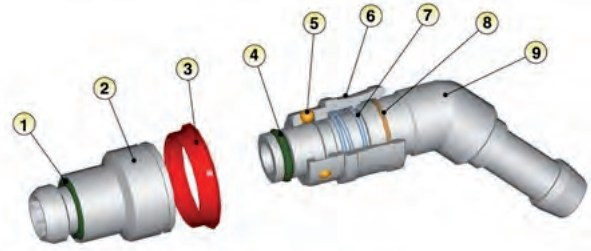

- 1+4. FKM O-ring
2. Forniklet messing studs
3. PA66 ring
5. Kugle, AISI 420
6. Forniklet messing udløserring
7. Fjeder, AISI 302
8. Bronze griber
9. Forniklet messing krop

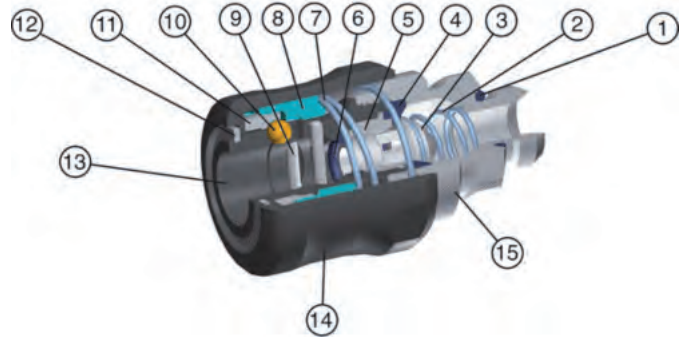

SERIE 660 - 670

- 1+6. NBR 70 O-ring
- 2+7. Fjeder, AISI 302
3. Forniklet messing lukkestyrer
4. NBR pakning
5. Forniklet messing ring
8. Forniklet messing aksel
9. Plast ring
10. Kugle, AISI 420
11. Kugle holder ring, AISI 303
12. Griber, AISI 302
13. Plast krop
14. Plast udløserring
15. Forniklet messing bagpart



	SERIE 200	SERIE 210	SERIE 220	SERIE 230	SERIE 240	SERIE 260	SERIE 270	SERIE 410-510	SERIE 660	SERIE 670
	0 - 10 bar	0 - 12 bar	0 - 16 bar	0 - 16 bar	0 - 25 bar	0 - 16 bar	0 - 12 bar	0 - 15 bar	-1 - 15 bar	-1 - 15 bar
	-18°C +80°C							0°C +110°C	-18°C +80°C	

FLOW KARAKTERISTIK FOR AUTOMATISKE LYNKOBLINGER 100 - 200 SERIEN

Flow karakteristisk med udstødning
til atmosfære

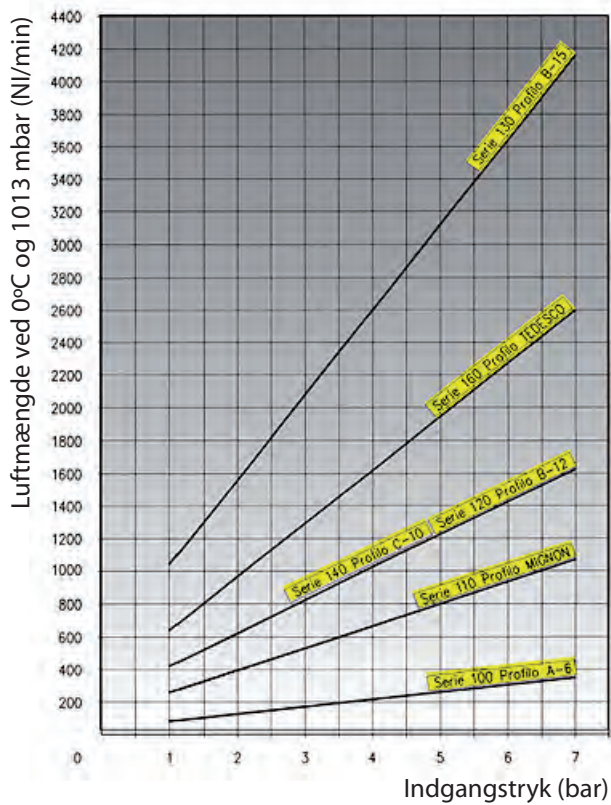

Flow karakteristisk med 1 bar tryktab

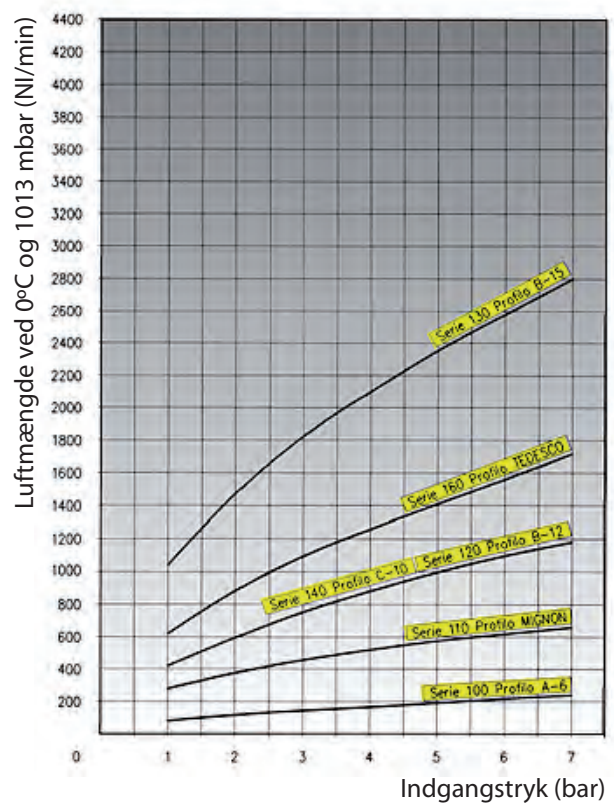

LYNKOBLING SERIE 200 MINI



0-10 bar



-18°C til +80°C



ISO 6150 A-6



Flow: 200L/min (6bar)

Kompatibilitet: Norma UNI ISO 6150 A-6

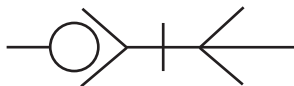

PROFIL SKALA 1:1

Lynkobling push-on

MESSING



Varenr.	Ø/ø	DKK
MA104-1	4/2,7	48,15
MA104-2	6/4	48,15

Nippel push-on

MESSING



Varenr.	Ø/ø	DKK
MA204-1	4/2,7	13,40
MA204-2	6/4	13,40

Lynkobling m. slangestuds

MESSING



Varenr.	Ø	DKK
MA105-1	4	45,55
MA105-2	6	45,55

Nippel m. slangestuds

MESSING



Varenr.	Ø	DKK
MA205-1	4	9,85
MA205-2	6	9,85

Lynkobling m. udv. gev.

MESSING - BSPP



Varenr.	BSPP	DKK
MA101-1	1/8"	41,95

Nippel m. udv. gevind

MESSING - BSPP



Varenr.	BSPP	DKK
MA201-1	1/8"	7,70

Lynkobling m. indiv. gev.

MESSING - BSPP



Varenr.	BSPP	DKK
MA102-1	1/8"	45,55

Nippel m. indiv. gevind

MESSING - BSPP



Varenr.	BSPP	DKK
MA202-1	1/8"	7,70

Ved push-on sættes slangen ned over en midterstuds med krave, der udvider slangen. Omløberens hul passer til den ikke-udvidede slange og klemmer derfor slangen fast, når den skrues på. Løsnes omløberen, kan slangen fjernes igen.

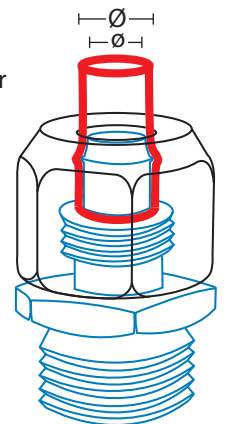

LYNKOBLING SERIE 210 MIGNON



0-12 bar



-18°C til +80°C



Flow: 200L/min (6bar)

Kompatibilitet:

Mignon, Rectus 21, Rectus 90, Camozzi
5150, Asturo 11400, Legris 21

KOBLINGER

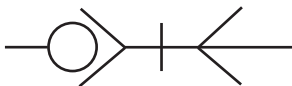

PROFIL SKALA 1:1

Lynkobling m. indiv. gev.

MESSING - BSPP



Varenr.	BSPP	DKK
MA112-1	1/8"	49,85
MA112-2	1/4"	49,85
MA112-3	3/8"	53,20

Lynkobling m. slangestuds

MESSING



Varenr.	Ø	DKK
MA115-1	4	49,50
MA115-2	6	49,50
MA115-3	8	49,50

Lynkobling m. udv. gev.

MESSING - BSPP



Varenr.	BSPP	DKK
MA111-1	1/8"	48,15
MA111-2	1/4"	48,15
MA111-3	3/8"	49,50

Lynkobling push-on

MESSING



Varenr.	Ø/ø	DKK
MA114-1	6/4	52,40
MA114-2	8/6	52,40

Lynkobling m. slangestuds

MESSING



Skotgennemføring		
Varenr.	Ø	DKK
MA119-1	4	65,55
MA119-2	6	66,10
MA119-3	8	67,75

Lynkobling m. udv. gev.

MESSING - BSPP



Skotgennemføring		
Varenr.	BSPP	DKK
MA116-1	1/8"	65,55
MA116-2	1/4"	66,10
MA116-3	3/8"	69,90

Lynkobling push-on

MESSING



Skotgennemføring		
Varenr.	Ø/ø	DKK
MA118-1	6/4	69,35
MA118-2	8/6	70,75

Lynkobling push-on

MESSING



Aflastningsfjeder		
Varenr.	Ø/ø	DKK
MA113-1	6/4	61,15
MA113-2	8/6	61,15

Lynkobling push-on

MESSING



Skotgennemføring, aflastfeder

Varenr.	Ø/ø	DKK
MA117-1	6/4	76,70
MA117-2	8/6	78,35

Nippel m. slangestuds

MESSING



Varenr.	Ø	DKK
MA215-1	4	8,80
MA215-2	6	8,80
MA215-3	8	10,65

Nippel m. udv. gevind

MESSING - BSPP



Varenr.	BSPP	DKK
MA211-1	1/8"	8,35
MA211-2	1/4"	10,05
MA211-3	3/8"	13,40

Nippel push-on

MESSING



Aflastningsfeder

Varenr.	Ø/ø	DKK
MA213-1	6/4	21,00
MA213-2	8/6	22,05

Nippel m. indiv. gevind

MESSING - BSPP



Varenr.	BSPP	DKK
MA212-1	1/8"	8,35
MA212-2	1/4"	10,05
MA212-3	3/8"	13,40

Ved push-on sættes slangen ned over en midterstuds med krave, der udvider slangen. Omløberens hul passer til den ikke-udvidede slange og klemmer derfor slangen fast, når den skrues på. Løsnes omløberen, kan slangen fjernes igen.

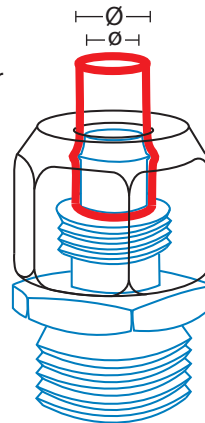

Nippel push-on

MESSING



Varenr.	Ø/ø	DKK
MA214-1	6/4	13,80
MA214-2	8/6	14,35

LYNKOBLING SERIE 210 MIGNON DOBBELT



0-12 bar



-18°C til +80°C



Flow: 200L/min (6bar)

Kompatibilitet:

Mignon, Rectus 21, Camozzi
5150, Asturo 11400, Legris 21

KOBLINGER

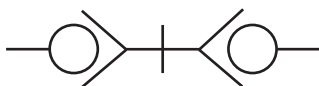

PROFIL SKALA 1:1

Lynkobling m. udv. gev.

MESSING - BSPP



Varenr.	BSPP	DKK
MA181-1	1/8"	53,50
MA181-2	1/4"	53,75
MA181-3	3/8"	58,15

Lynkobling m. indiv. gev.

MESSING - BSPP



Varenr.	BSPP	DKK
MA182-1	1/8"	58,15
MA182-2	1/4"	58,75
MA182-3	3/8"	61,45

Lynkobling push-on

MESSING



Varenr.	Ø/ø	DKK
MA184-1	6/4	60,05
MA184-2	8/6	61,70

Lynkobling m. slangestuds

MESSING



Varenr.	Ø	DKK
MA185-1	4	58,45
MA185-2	6	58,45
MA185-3	8	58,45

Lynkobling push-on

MESSING



Aflastningsfjeder

Varenr.	Ø/ø	DKK
MA183-1	6/4	67,75
MA183-2	8/6	68,50

Nippel m. udv. gevind

MESSING - BSPP



Varenr.	BSPP	DKK
MA281-1	1/8"	30,70
MA281-2	1/4"	32,95
MA281-3	3/8"	35,20

Nippel m. indiv. gevind

MESSING - BSPP



Varenr.	BSPP	DKK
MA282-1	1/8"	35,75
MA282-2	1/4"	38,05
MA282-3	3/8"	39,10

Nippel push-on

MESSING



Varenr.	Ø/ø	DKK
MA283-1	6/4	42,75
MA283-2	8/6	43,40

Nippel m. slangestuds

MESSING



Varenr.	Ø	DKK
MA285-1	4	32,10
MA285-2	6	32,10
MA285-3	8	35,50

Nippel push-on

MESSING



Aflastningsfjeder

Varenr.	Ø/ø	DKK
MA284-1	6/4	35,50
MA284-2	8/6	36,05

Ved push-on sættes slangen ned over en midterstuds med krave, der udvider slangen. Omløberens hul passer til den ikke-udvidede slange og klemmer derfor slangen fast, når den skrues på. Løsnes omløberen, kan slangen fjernes igen.

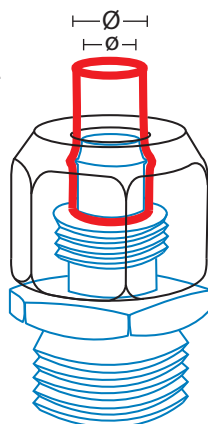

LYNKOBLING SERIE 220 NORMA



0-16 bar



-18°C til +80°C



ISO 6150 B-12



Flow: 1100L/min (6 bar)

Kompatibilitet: Norma UNI ISO 6150
B-12, Rectus 23, Rectus 24, US-MIL SPEC
C-4109, Hansen 3000, Gromelle 600,
Parker 30 1/4, CEJN 310, JWL 521/531,
Nordgren Dynaquip DC3

KOBLINGER

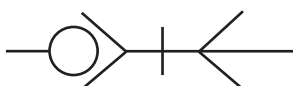

PROFIL SKALA 1:1

Lynkobling push-on

MESSING



Varenr.	Ø/ø	DKK
MA124-1	6/4	61,15
MA124-2	8/6	63,05
MA124-3	10/8	63,05

Nippel m. udv. gevind

MESSING - BSPP



Varenr.	BSPP	DKK
MA221-1	1/4"	13,20
MA221-2	3/8"	15,30
MA221-3	1/2"	22,05

Lynkobling m. udv. gev.

MESSING - BSPP



Varenr.	BSPP	DKK
MA121-1	1/4"	62,80
MA121-2	3/8"	62,80
MA121-3	1/2"	68,25

Lynkobling m. slangestuds

MESSING



Varenr.	Ø	DKK
MA125-1	6	66,60
MA125-2	8	66,60
MA125-3	10	66,60
MA125-4	12	66,60

Nippel m. indiv. gevind

MESSING - BSPP

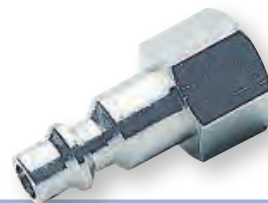

Varenr.	BSPP	DKK
MA222-1	1/4"	13,20
MA222-2	3/8"	15,60
MA222-3	1/2"	22,70

Lynkobling m. indiv. gev.

MESSING - BSPP



Varenr.	BSPP	DKK
MA122-1	1/4"	66,60
MA122-2	3/8"	66,60
MA122-3	1/2"	71,25

Lynkobling push-on

MESSING



Aflastningsfjeder		
Varenr.	Ø/ø	DKK
MA123-1	6/4	76,70
MA123-2	8/6	78,65
MA123-3	10/8	78,65

Nippel push-on

MESSING



Varenr.	Ø/ø	DKK
MA224-1	6/4	15,60
MA224-2	8/6	16,15
MA224-3	10/8	19,20
MA224-4	12/10	19,20

Nippel m. slangestuds

MESSING



Varenr.	Ø	DKK
MA225-1	6	10,85
MA225-2	8	11,90
MA225-3	10	13,20
MA225-4	12	14,35

Nippel push-on

MESSING



Aflastningsfeder

Varenr.	Ø/ø	DKK
MA223-1	6/4	23,85
MA223-2	8/6	24,85
MA223-3	10/8	28,10
MA223-4	12/10	28,10

Ved push-on sættes slangen ned over en midterstuds med krave, der udvider slangen. Omløberens hul passer til den ikke-udvidede slange og klemmer derfor slangen fast, når den skrues på. Løsnes omløberen, kan slangen fjernes igen.

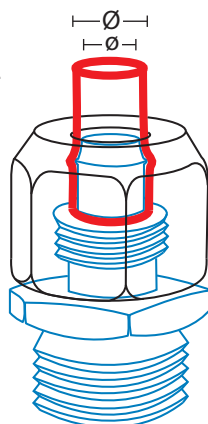

LYNKOBLING SERIE 230 NORMA



0-16 bar



-18°C til +80°C



ISO 6150



KOBLINGER

Flow: 2600L/min (6bar)

Kompatibilitet: Norma UNI ISO 6150 B-15, Rectus 30, US_MIL SPEC C-4109, Hansen 4000, Gromelle 90, ARO, Parker 30 3/8

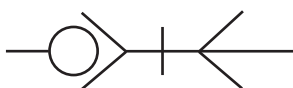

PROFIL SKALA 1:1

Lynkobling m. udv. gev.

MESSING - BSPP



Varenr.	BSPP	DKK
MA131-1	3/8"	74,80
MA131-2	1/2"	74,80

Lynkobling m. indiv. gev.

MESSING - BSPP



Varenr.	BSPP	DKK
MA132-1	3/8"	79,45
MA132-2	1/2"	79,45

Lynkobling push-on

MESSING



Varenr.	Ø/ø	DKK
MA134-1	10/8	75,35
MA134-2	12/10	75,35

Lynkobling m. slangestuds

MESSING



Varenr.	Ø	DKK
MA135-1	8	79,75
MA135-2	10	79,75
MA135-3	12	79,75

Lynkobling push-on

MESSING



Aflastningsfjeder

Varenr.	Ø/ø	DKK
MA133-1	10/8	85,20
MA133-2	12/10	85,20

Nippel m. udv. gevind

MESSING - BSPP



Varenr.	BSPP	DKK
MA231-1	3/8"	16,15
MA231-2	1/2"	22,70

Nippel m. indiv. gevind

MESSING - BSPP



Varenr.	BSPP	DKK
MA232-1	3/8"	17,05
MA232-2	1/2"	24,55

Nippel push-on

MESSING



Varenr.	Ø/ø	DKK
MA234-1	10/8	17,60
MA234-2	12/10	19,20

Nippel m. slangestuds

MESSING



Varenr.	Ø	DKK
MA235-1	8	15,30
MA235-2	10	13,80

Nippel push-on

MESSING



Aflastningsfjeder

Varenr.	Ø/ø	DKK
MA233-1	10/8	28,10
MA233-2	12/10	32,10

Ved push-on sættes slangen ned over en midterstuds med krave, der udvider slangen. Omløberens hul passer til den ikke-udvidede slange og klemmer derfor slangen fast, når den skrues på. Løsnes omløberen, kan slangen fjernes igen.

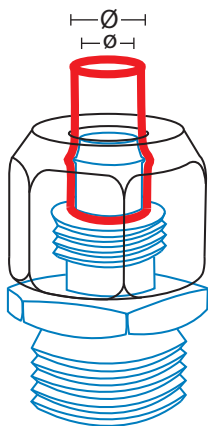

LYNKOBLING SERIE 240 NORMA



0-25 bar



-18°C til +80°C



ISO 6150 C-10



KOBLINGER

Flow: 1100L/min (6 bar)

Kompatibilitet: Norma UNI ISO 6150 C-10, Rectus 18, Staubli RCS-RBE 6, Oetiker ISO Standard DP 6150, CEJN 291, Gromelle, Legris 18

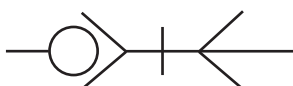

PROFIL SKALA 1:1

Lynkobling push-on

MESSING



Varenr.	Ø/ø	DKK
MA144-1	6/4	59,80
MA144-2	8/6	59,80
MA144-3	10/8	60,90

Nippel m. udv. gevind

MESSING - BSPP



Varenr.	BSPP	DKK
MA241-1	1/4"	13,40
MA241-2	3/8"	15,30
MA241-3	1/2"	23,60

Lynkobling m. udv. gev.

MESSING - BSPP



Varenr.	BSPP	DKK
MA141-1	1/4"	59,80
MA141-2	3/8"	59,80
MA141-3	1/2"	64,95

Lynkobling m. slangestuds

MESSING



Varenr.	Ø	DKK
MA145-1	6	63,65
MA145-2	8	63,65
MA145-3	10	63,65
MA145-4	12	57,90

Nippel m. indiv. gevind

MESSING - BSPP

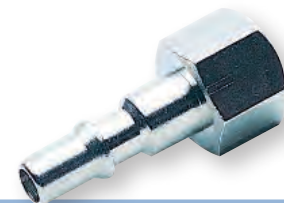

Varenr.	BSPP	DKK
MA242-1	1/4"	13,80
MA242-2	3/8"	15,60
MA242-3	1/2"	24,25

Lynkobling m. indiv. gev.

MESSING - BSPP



Varenr.	BSPP	DKK
MA142-1	1/4"	65,55
MA142-2	3/8"	65,55
MA142-3	1/2"	70,15

Lynkobling push-on

MESSING



Aflastningsfjeder

Varenr.	Ø/ø	DKK
MA143-1	6/4	68,00
MA143-2	8/6	68,00
MA143-3	10/8	69,65

Nippel push-on

MESSING



Varenr.	Ø/ø	DKK
MA244-1	6/4	16,15
MA244-2	8/6	17,60
MA244-3	10/8	18,95

Nippel m. slangestuds

MESSING



Varenr.	Ø	DKK
MA245-1	6	10,25
MA245-2	8	11,70
MA245-3	10	12,90
MA245-4	12	13,40

Nippel push-on

MESSING



Aflastningsfeder

Varenr.	Ø/ø	DKK
MA243-1	6/4	24,25
MA243-2	8/6	26,00
MA243-3	10/8	28,10

Ved push-on sættes slangen ned over en midterstuds med krave, der udvider slangen. Omløberens hul passer til den ikke-udvidede slange og klemmer derfor slangen fast, når den skrues på. Løsnes omløberen, kan slangen fjernes igen.

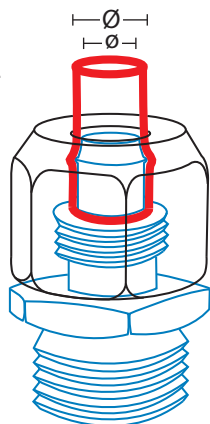

LYNKOBLING SERIE 260 TEDESCO

DE MEST BRUGTE KOBLINGER I NORDEN



0-16 bar



-18°C til +80°C



Flow: 2600L/min (6 bar)

Kompatibilitet: Standard Tedesco, Rectus 25/26, CEJN 320, Camozzi 5180, JWL 520/530, Festo KD serie, TST, Asturo 11140, Legris 25/26, Prevost ERC07

Mest brugte luftkobling i Nordeuropa.

KOBLINGER

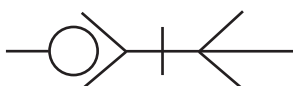

PROFIL SKALA 1:1

Lynkobling push-on

MESSING



Varenr.	Ø/ø	DKK
MA164-1	6/4	67,75
MA164-2	8/6	69,10
MA164-3	10/8	69,10

Nippel m. udv. gevind

MESSING - BSPP



Varenr.	BSPP	DKK
MA261-1	1/4"	17,15
MA261-2	3/8"	18,35
MA261-3	1/2"	22,25

Lynkobling m. udv. gev.

MESSING - BSPP



Varenr.	BSPP	DKK
MA161-1	1/4"	71,55
MA161-2	3/8"	73,45
MA161-3	1/2"	78,65

Lynkobling m. slangestuds

MESSING



Varenr.	Ø	DKK
MA165-1	6	66,10
MA165-2	8	66,10
MA165-3	10	66,10
MA165-4	12	66,10

Nippel m. indiv. gevind

MESSING - BSPP



Varenr.	BSPP	DKK
MA262-1	1/4"	17,85
MA262-2	3/8"	20,05
MA262-3	1/2"	21,15

Lynkobling m. indiv. gev.

MESSING - BSPP



Varenr.	BSPP	DKK
MA162-1	1/4"	66,10
MA162-2	3/8"	66,10
MA162-3	1/2"	71,00

Lynkobling push-on

MESSING



Aflastningsfjeder		
Varenr.	Ø/ø	DKK
MA163-1	6/4	75,35
MA163-2	8/6	78,35
MA163-3	10/8	78,35

Nippel push-on

MESSING



Varenr.	Ø/ø	DKK
MA264-1	6/4	15,05
MA264-2	8/6	15,85
MA264-3	10/8	17,05

Nippel m. slangestuds

MESSING



Varenr.	Ø	DKK
MA265-1	6	9,60
MA265-2	8	11,80
MA265-3	10	12,20
MA265-4	12	14,70

Nippel push-on

MESSING



Aflastningsfeder

Varenr.	Ø/ø	DKK
MA263-1	6/4	22,45
MA263-2	8/6	23,30
MA263-3	10/8	25,15

Ved push-on sættes slangen ned over en midterstuds med krave, der udvider slangen. Omløberens hul passer til den ikke-udvidede slange og klemmer derfor slangen fast, når den skrues på. Løsnes omløberen, kan slangen fjernes igen.

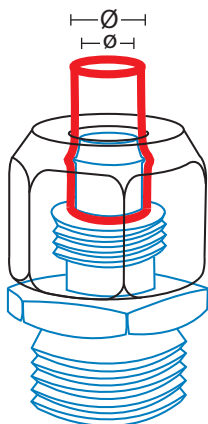

LYNKOBLING SERIE 520 JWL



1-35 bar



-20°C til +60°C



JWL er produceret med meget høj kvalitet og et program med fantastisk stabilitet.

Standard: EURO

Flowdiameter: 7,8mm

Kompatibilitet: Cejn 320, Hansen Auto Flo 24, Proquix 1420 & 1421, Legris 94xx A, Oetiker SC Series C, Prevost ESC 07 / ERC 07, Rectus-Tema 25, 26 & 1600.

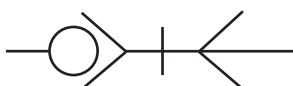

PROFIL SKALA 1:1



JWL lynkobling m. indiv. gev.

STÅL - BSPP



Varenr.	BSPP	Type	DKK
JT50-2	1/4"	520	175,50
JT50-3	3/8"	520	175,50
JT50-4	1/2"	520	192,25

JWL nippel m. indiv. gevind

STÅL - BSPP



Varenr.	BSPP	Type	DKK
JT53-2	1/4"	520	36,55
JT53-3	3/8"	520	49,40
JT53-4	1/2"	520	84,10

JWL lynkobling m. udv. gev.

STÅL - BSPT



Varenr.	BSPT	Type	DKK
JT51-2	1/4"	520	175,50
JT51-3	3/8"	520	175,50
JT51-4	1/2"	520	192,25

JWL nippel m. udv. gevind

STÅL - BSPT

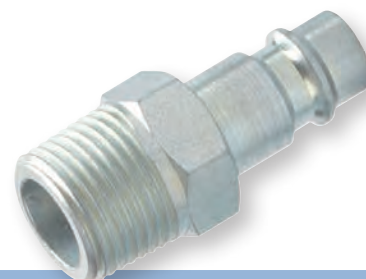

Varenr.	BSPT	Type	DKK
JT54-2	1/4"	520	39,90
JT54-3	3/8"	520	49,15
JT54-4	1/2"	520	84,10

JWL lynkobling slangestuds

STÅL



Varenr.	Ø	Type	DKK
JT52-6	6	520	175,50
JT52-8	8	520	175,50
JT52-10	10	520	175,75
JT52-13	13	520	192,25

JWL nippel slangestuds

STÅL

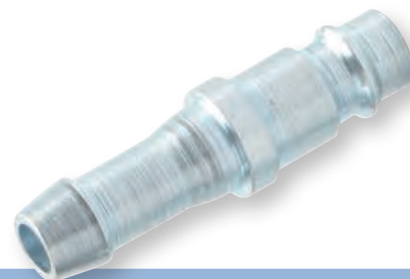

Varenr.	Ø	Type	DKK
JT55-6	6	520	39,90
JT55-8	8	520	39,90
JT55-10	10	520	49,15
JT55-13	13	520	49,15

LYNKOBLING SERIE 270 SVENSK



0-16 bar



-18°C til +80°C



Flow: 600L/min (6 bar)

Kompatibilitet: Standard Svedese, Rectus 14, Rectus 22, CEJN 300, ARO 210, Parker 50, Orion 44510, JWL 522/523, Asturo 11110, Legris 14/24, Prevost ARM06

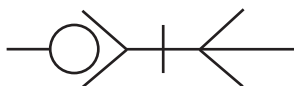

PROFIL SKALA 1:1

Lynkobling push-on

MESSING



Varenr.	Ø/ø	DKK
MA194-1	6/4	6298,50
MA194-2	8/6	64,45
MA194-3	10/8	64,45

Nippel m. udv. gevind

MESSING - BSPP



Varenr.	BSPP	DKK
MA271-1	1/4"	12,55
MA271-2	3/8"	14,35
MA271-3	1/2"	20,70

Lynkobling m. udv. gev.

MESSING - BSPP



Varenr.	BSPP	DKK
MA191-1	1/4"	64,20
MA191-2	3/8"	64,20
MA191-3	1/2"	68,85

Lynkobling m. slangestuds

MESSING



Varenr.	Ø	DKK
MA195-1	6	68,50
MA195-2	8	68,50
MA195-3	10	68,50
MA195-4	12	68,50

Nippel m. indiv. gevind

MESSING - BSPP



Varenr.	BSPP	DKK
MA272-1	1/4"	13,20
MA272-2	3/8"	15,05
MA272-3	1/2"	21,80

Lynkobling m. indiv. gev.

MESSING - BSPP



Varenr.	BSPP	DKK
MA192-1	1/4"	68,50
MA192-2	3/8"	68,50
MA192-3	1/2"	72,90

Lynkobling push-on

MESSING



Aflastningsfjeder		
Varenr.	Ø/ø	DKK
MA193-1	6/4	71,00
MA193-2	8/6	73,45
MA193-3	10/8	80,85

Nippel push-on

MESSING



Varenr.	Ø/ø	DKK
MA274-1	6/4	15,05
MA274-2	8/6	15,85
MA274-3	10/8	18,20

Nippel m. slangestuds

MESSING



Varenr.	Ø	DKK
MA275-1	6	10,65
MA275-2	8	11,80
MA275-3	10	13,20
MA275-4	12	14,10

Nippel push-on

MESSING



Aflastningsfeder

Varenr.	Ø/ø	DKK
MA273-1	6/4	20,80
MA273-2	8/6	21,70
MA273-3	10/8	26,95

Ved push-on sættes slangen ned over en midterstuds med krave, der udvider slangen. Omløberens hul passer til den ikke-udvidede slange og klemmer derfor slangen fast, når den skrues på. Løsnes omløberen, kan slangen fjernes igen.

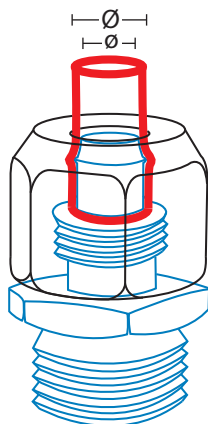

LYNKOBLING SERIE 410-510



Max 15 bar



0°C til +110°C



Flow:

Kompatibilitet: Staubli

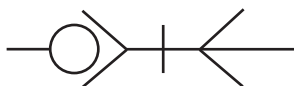

PROFIL SKALA 1:1

Nippel 45° slangestuds

MESSING



Varenr.	Ø	DKK
MA416-1	8	119,25
MA416-2	10	119,25
MA416-3	12	119,25

Lynkobling m. udv. gev.

MESSING - BSPP



Varenr.	BSPP	L	DKK
MA512-1	1/8"	50mm	82,50
MA512-2	1/8"	100mm	137,25
MA512-3	1/8"	150mm	175,75
MA512-4	1/8"	200mm	225,50
MA512-5	1/4"	50mm	82,50
MA512-6	1/4"	100mm	137,25
MA512-7	1/4"	150mm	175,75
MA512-8	1/4"	200mm	225,50
MA512-9	3/8"	50mm	82,50
MA512-10	3/8"	100mm	137,25
MA512-11	3/8"	150mm	175,75
MA512-12	3/8"	200mm	225,50

Lynkobling indvendig gevind

MESSING - BSPP



Varenr.	BSPP	DKK
MA412-1	1/4"	86,55

Nippel 90° slangestuds

MESSING



Varenr.	Ø	DKK
MA418-1	8	110,25
MA418-2	10	110,25
MA418-3	12	110,25

Nippel med slangestuds

MESSING



Varenr.	Ø	DKK
MA415-1	8	88,75
MA415-2	10	88,75
MA415-3	12	88,75

Lynkobling m. udv. gev.

MESSING - BSPP



Varenr.	BSPP	DKK
MA511-1	1/8"	20,30
MA511-2	1/4"	20,30
MA511-3	3/8"	23,30

Identifikationsring

PA (POLYAMID)



Varenr.	Str.	farve	DKK
MA513R-1	1/8"	rød/red	5,45
MA513R-2	1/4"	rød/red	5,45
MA513R-3	3/8"	rød/red	5,45
MA513B-1	1/8"	blå/blue	5,45
MA513B-2	1/4"	blå/blue	5,45
MA513B-3	3/8"	blå/blue	5,45

LYNKOBLING SERIE 660 EUROPÆISK



1-15 bar



-18°C til +80°C



Flow: 1000L/min (6 bar)

Kompatibilitet: Standard Tedesco, Rectus 25/26, CEJN 320, Camozzi 5180, JWL 520/530, Festo KD serie, TST, Asturo 11140, Legris 25/26, Prevost ERC07

To-trinskobling:
Trin 1: trykudløsning
Trin 2: afkobling

KOBLINGER

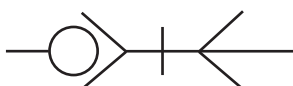

PROFIL SKALA 1:1

Lynkobling push-on

MESSING



Sikkerhedskobling

Varenr.	Ø/ø	DKK
MA664-1	6/4	187,50
MA664-2	8/6	187,50
MA664-3	10/6,5	188,00
MA664-4	10/8	188,00
MA664-5	12/8	197,00
MA664-6	12/10	197,00

Nippel m. indiv. gevind

MESSING - BSPP



Varenr.	BSPP	DKK
MA262-1	1/4"	17,85
MA262-2	3/8"	20,05
MA262-3	1/2"	21,15

Lynkobling m. udv. gev.

MESSING - BSPP



Sikkerhedskobling

Varenr.	BSPP	DKK
MA661-1	1/4"	181,75
MA661-2	3/8"	183,75
MA661-3	1/2"	193,75

Lynkobling m. slangestuds

MESSING



Sikkerhedskobling

Varenr.	Ø	DKK
MA665-1	6	185,75
MA665-2	8	185,75
MA665-3	10	185,75
MA665-4	12	188,50

Nippel m. slangestuds

MESSING



Varenr.	Ø	DKK
MA265-1	6	9,60
MA265-2	8	11,80
MA265-3	10	12,20
MA265-4	12	14,70

Lynkobling m. indiv. gev.

MESSING - BSPP



Sikkerhedskobling

Varenr.	BSPP	DKK
MA662-1	1/4"	185,75
MA662-2	3/8"	190,25
MA662-3	1/2"	195,75

Nippel m. udv. gevind

MESSING - BSPP



Varenr.	BSPP	DKK
MA261-1	1/4"	17,15
MA261-2	3/8"	18,35
MA261-3	1/2"	22,25

Aflastningshylse

EPDM



Varenr.	Str.	DKK
MA628-1	6/8/10/12	9,60

LYNKOBLING SERIE 670 SVENSK



1-15 bar



-18°C til +80°C



Flow: 800L/min (6 bar)

Kompatibilitet: Standard Svedese, Rectus 14, Rectus 22, CEJN 300, ARO 210, Parker 50, Orion 44510, JWL 522/523, Asturo 11110, Legris 14/24, Prevost ARM06

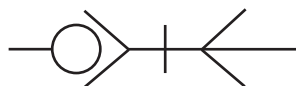

PROFIL SKALA 1:1

Lynkobling push-on

MESSING



Sikkerhedskobling

Varenr.	Ø/ø	DKK
MA674-1	6/4	199,00
MA674-2	8/6	199,00
MA674-3	10/6,5	199,50
MA674-4	10/8	199,50
MA674-5	12/8	209,00
MA674-6	12/10	209,00

Nippel m. indiv. gevind

MESSING - BSPP



Varenr.	BSPP	DKK
MA272-1	1/4"	13,20
MA272-2	3/8"	15,05
MA272-3	1/2"	21,80

Lynkobling m. udv. gev.

MESSING - BSPP



Sikkerhedskobling

Varenr.	BSPP	DKK
MA671-1	1/4"	192,50
MA671-2	3/8"	194,75
MA671-3	1/2"	205,25

Lynkobling m. slangestuds

MESSING



Sikkerhedskobling

Varenr.	Ø	DKK
MA675-1	6	196,75
MA675-2	8	196,75
MA675-3	10	196,75
MA675-4	12	200,00

Nippel m. slangestuds

MESSING



Varenr.	Ø	DKK
MA275-1	6	10,65
MA275-2	8	11,80
MA275-3	10	13,20
MA275-4	12	14,10

Lynkobling m. indiv. gev.

MESSING - BSPP



Sikkerhedskobling

Varenr.	BSPP	DKK
MA672-1	1/4"	196,75
MA672-2	3/8"	201,50
MA672-3	1/2"	207,75

Nippel m. udv. gevind

MESSING - BSPP



Varenr.	BSPP	DKK
MA271-1	1/4"	12,55
MA271-2	3/8"	14,35
MA271-3	1/2"	20,70

LYNKOBLING SERIE 800 MINI



0-10 bar



-18°C til +80°C



Serie af mini lynkoblinger med slangetilslutning ned til 4/2,7mm og med M5 eller 1/8" gevind.

Flow: 236L/min (6 bar)

Kompatibilitet: Serto KA202 og Serto coT 203

KOBLINGER

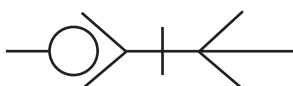

PROFIL SKALA 1:1

Lynkobling m. udv. gev.

MESSING - BSPP



Varenr.	BSPP	DKK
MA701-1	M5	50,65
MA701-2	1/8"	50,65

Nippel m. udv. gevind

MESSING - BSPP



Varenr.	BSPP	DKK
MA801-1	M5	8,15
MA801-2	1/8"	8,15

Lynkobling m. indiv. gev.

MESSING - BSPP

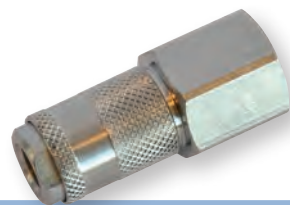

Varenr.	BSPP	DKK
MA702-1	M5	54,00
MA702-2	1/8"	54,00

Nippel push-on

MESSING

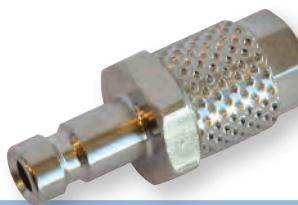

Varenr.	Ø/ø	DKK
MA804-1	4/2,7	14,40
MA804-2	6/4	14,40

Lynkobling push-on

MESSING

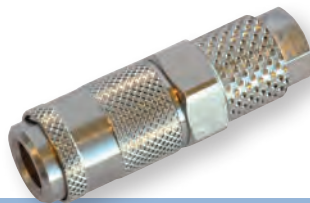

Varenr.	Ø/ø	DKK
MA704-1	4/2,7	56,25
MA704-2	6/4	56,25

Nippel m. indiv. gevind

MESSING - BSPP



Varenr.	BSPP	DKK
MA802-1	M5	8,15
MA802-2	1/8"	8,15

LYNKOBLING ISO B



Se tekst



AISI 316: -20°C til +200°C
Messing: -18°C til +80°C



ISO B



Flow (6 bar): se hver varelinie

Fordele: Robust konstruktion, enhåndsudløsning.

Kompatibilitet: PARKER, HANSEN HK (ISO 7241 Serie B).

Max tryk AISI 316:

1/4" = 250 bar

3/8" = 230 bar

1/2" = 200 bar

3/4" = 160 bar

Max tryk messing:

- 150 bar

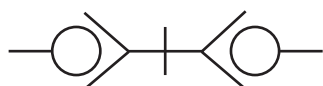

ISO B lynkobling m. indv. gevind

AISI 316 / VITON - BSPP



Varenr.	BSPP	L/min	DKK
B111-1	1/8"	2	215,00
B111-2	1/4"	4.5	303,25
B111-3	3/8"	12.5	399,00
B111-4	1/2"	27	577,00
B111-5	3/4"	53	965,25
B111-6	1"	110	1190,75

ISO B nippel m. indv. gevind

AISI 316 / VITON - BSPP



Varenr.	BSPP	L/min	DKK
B112-1	1/8"	2	121,50
B112-2	1/4"	4.5	138,00
B112-3	3/8"	12.5	172,50
B112-4	1/2"	27	234,00
B112-5	3/4"	53	442,75
B112-6	1"	110	558,25

ISO B kobling m. indv. gevind

MESSING / NBR - BSPP



Varenr.	BSPP	L/min	DKK
M300-1	1/8"	2	74,55
M300-2	1/4"	4.5	85,20
M300-3	3/8"	12.5	140,50
M300-4	1/2"	27	224,25
M300-5	3/4"	53	358,25
M300-6	1"	110	614,75

ISO B nippel m. indv. gevind

MESSING / NBR - BSPP



Varenr.	BSPP	L/min	DKK
M301-1	1/8"	2	32,40
M301-2	1/4"	4.5	37,15
M301-3	3/8"	12.5	60,65
M301-4	1/2"	27	96,40
M301-5	3/4"	53	154,25
M301-6	1"	110	263,25

Støvhætte han ISO B

GUMMI



Varenr.	Dim	DN	DKK
M309-2	1/4"	6	57,70
M309-3	3/8"	13	57,70
M309-4	1/2"	13	59,75
M309-5	3/4"	20	70,05

Støvprop hun ISO B

GUMMI



Varenr.	Dim	DN	DKK
M310-2	1/4"	6	57,70
M310-3	3/8"	10	57,70
M310-4	1/2"	10	65,95
M310-5	3/4"	20	70,05

LYNKOBLING PLASTIK



Max 14 bar



-20°C til +110°C



Lynkobling med forskellige tilslutninger. Kobling produceret af Acetal med rustfri fjeder og med NBR O-ring. Kan bruges både til luft og vand.

KOBLINGER

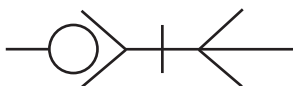

Lynkobling m. indv. gevind

POM (ACETAL) - BSPP



Varenr.	BSPP	DKK
A27-1	1/4"	90,10

Nippel m. indv. gevind

POM (ACETAL) - BSPP



Varenr.	BSPP	DKK
A28-2	1/4"	27,25

Nippel m. udv. gevind

POM (ACETAL) - BSPT



Varenr.	BSPT	DKK
A28-1	1/4"	27,25

Nippel m. slangestuds

POM (ACETAL)



Varenr.	Ø	DKK
A28-3	5	27,25
A28-4	6	27,25
A28-5	8	27,25
A28-6	10	27,25
A28-7	12	27,25

JWL KOBLINGER OG TRYKLUFTPISTOLER



Bredt program af JWL blæsepistoler og tilbehør. JWL er produceret med meget høj kvalitet og et program med fantastisk stabilitet.

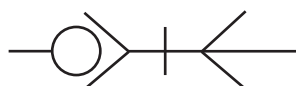

PROFIL SKALA 1:1

JWL lynkobling m. udv. gev. STÅL - BSPT



Varenr.	BSPT	Type	DKK
JT51-2	1/4"	520	175,50
JT51-3	3/8"	520	175,50
JT51-4	1/2"	520	192,25

JWL nippel m. indv. gevind STÅL - BSPP



Varenr.	BSPP	Type	DKK
JT53-2	1/4"	520	36,55
JT53-3	3/8"	520	49,40
JT53-4	1/2"	520	84,10



JWL lynkobling m. indv. gev. STÅL - BSPP



Varenr.	BSPP	Type	DKK
JT50-2	1/4"	520	175,50
JT50-3	3/8"	520	175,50
JT50-4	1/2"	520	192,25

JWL nippel m. udv. gevind STÅL - BSPT



Varenr.	BSPT	Type	DKK
JT54-2	1/4"	520	39,90
JT54-3	3/8"	520	49,15
JT54-4	1/2"	520	84,10

JWL lynkobling slangestuds STÅL



Varenr.	Ø	Type	DKK
JT52-6	6	520	175,50
JT52-8	8	520	175,50
JT52-10	10	520	175,75
JT52-13	13	520	192,25

JWL nippel slangestuds STÅL

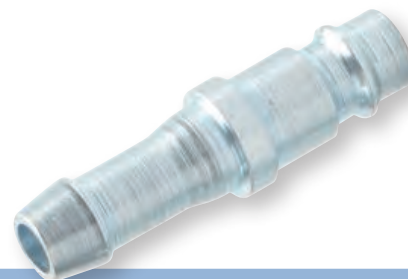

Varenr.	Ø	Type	DKK
JT55-6	6	520	39,90
JT55-8	8	520	39,90
JT55-10	10	520	49,15
JT55-13	13	520	49,15

JWL blæsepistol m. bøjet rør

BSPP



-10°C til +80°C, 8mm rør

Varenr.	BSPP	DKK
JT60-1	1/4"	177,75

Max 16 bar - 380L/min (8 bar)

JWL blæsepistol m. lige rør

BSPP



-10°C til +80°C, 8mm rør

Varenr.	BSPP	L	DKK
JT61-1	1/4"	0,3m	214,00
JT61-2	1/4"	0,5m	230,75
JT61-4	1/4"	1,0m	286,00
JT61-5	1/4"	1,5m	1839,75
JT61-6	1/4"	2,0m	2092,00

Max 16 bar - 380L/min (8 bar)

JWL rensepistol

BSPP



Kunststoffdyse

Varenr.	BSPP	L	Vol.	DKK
JT62-1	1/4"	150mm	1,2L	619,75
JT62-2	1/4"	200mm	1,2L	619,75

JWL vaskepistol

BSPP



Varenr.	BSPP	DKK
JT63-1	1/4"	595,75

JWL bremseudluffer

BSPP



Standard med beholder

Varenr.	BSPP	Vol.	DKK
JT64-1	1/4"	1,2L	1150,75
JT64-2	1/4"	2,0L	1271,25

JWL bremseudluffer

BSPP



Til motorcykel med beholder

Varenr.	BSPP	Vol.	DKK
JT65-1	1/4"	1,2L	1203,25

JWL boldpistol inkl. pumpenål

BSPP



Varenr.	BSPP	DKK
JT66-1	1/4"	312,50

JWL universal pumpepistol

BSPP



8mm bøjet rør til cykler

Varenr.	BSPP	DKK
JT67-1	1/4"	307,75

JWL pumpepistol manometer

BSPP



0,5m slange

Varenr.	BSPP	Ø	DKK
JT68-1	1/4"	63	800,25
JT68-2	1/4"	80	913,00

JWL sandblæser med beholder

BSPP



Varenr.	BSPP	Vol.	DKK
JT69-1	1/4"	1,2L	692,00

JWL sandblæsesæt

BSPP

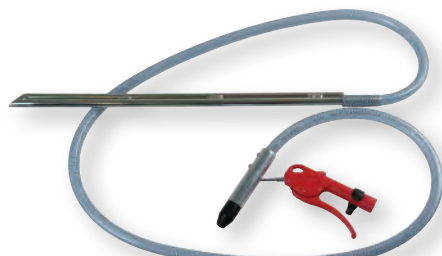

Varenr.	BSPP	DKK
JT70-1	1/4"	1547,25

JWL sprøjte med kunststof-sugerør

BSPP



Passer på engangsdåser

Varenr.	BSPP	DKK
JT71-1	1/4"	607,75

JWL hulrumsslange sæt BSPP



Med 2 sugerør og hulrumsslange

Varenr.	Str.	DKK
JT72-1	-	1736,75

JWL standard malersprøjte



1L underkop

Varenr.	DS	DKK
JT76-1	1,6mm	1765,50
JT76-2	2,0mm	1765,50

DS = dysestørrelse

JWL spiralslange PUR (POLYURETHAN)



Med JWL 530 kobling+nippel, max 10bar

Varenr.	ø × Ø	Type	L	DKK
JT80-1-1	4 × 6	530	1m	715,75
JT80-2-1	5 × 8	530	1m	800,25
JT80-2-2	5 × 8	530	2m	833,75
JT80-2-4	5 × 8	530	4m	949,00
JT80-2-6	5 × 8	530	6m	1033,25
JT80-2-8	5 × 8	530	8m	1197,00
JT80-3-2	6,5 × 10	530	2m	924,75
JT80-3-4	6,5 × 10	530	4m	1014,00
JT80-3-6	6,5 × 10	530	6m	1282,50
JT80-3-8	6,5 × 10	530	8m	1424,50
JT80-4-2	8 × 12	530	2m	1085,75
JT80-4-4	8 × 12	530	4m	1282,50
JT80-4-6	8 × 12	530	6m	1558,50
JT80-4-8	8 × 12	530	8m	1919,00

JWL hulrumsslange



Med ø8mm drypfri inderlange

Varenr.	L	DKK
JT73-1	0,9m	206,75
JT73-2	1,5m	286,00
JT73-3	2,0m	319,75
JT73-4	3,0m	367,75

JWL standard malersprøjte



0,6L overkop

Varenr.	DS	DKK
JT77-1	1,4mm	2687,50
JT77-2	1,7mm	2687,50
JT77-3	2,0mm	2687,50

DS = dysestørrelse

JWL slange blød armeret PVC (POLYVINYLCHLORID)



Med JWL 520 kobling+nippel, max 15bar

Varenr.	ø × Ø	Type	L	DKK
JT81-1-5	6,3 × 11	520	5m	471,00
JT81-1-10	6,3 × 11	520	10m	610,25
JT81-1-15	6,3 × 11	520	15m	831,25
JT81-1-20	6,3 × 11	520	20m	987,50
JT81-2-5	9 × 14,5	520	5m	547,50
JT81-2-10	9 × 14,5	520	10m	751,75
JT81-2-15	9 × 14,5	520	15m	1049,75
JT81-2-20	9 × 14,5	520	20m	1237,25

JWL oliesuger til små motorer BSPP



Varenr.	BSPP	Vol.	DKK
JT74-1	1/4"	1,2L	1121,75

JWL professionel malerpistol



1L underkop

Varenr.	DS	DKK
JT78-1	2,2mm	3454,75

DS = dysestørrelse

HJÆLP OS MED AT UDVIKLE ROYKON A/S

Vi har brug for din hjælp til at udvikle os i den rigtige retning.

Hvis du har ideer til nye produkter eller du kender en, der kan bruge vores produkter, så vent ikke med at henvende dig til os.

Vi elsker nye udfordringer med hensyn til nye produkter og hvis du kunne tænke dig, at vi havde et bestemt produkt i vores program, så skriv eller ring til os.

Vi sender også gerne vores katalog til en person, som du mener burde have det. Du er selvfølgelig også velkommen til at rekvirere flere kataloger til jeres virksomhed, hellere et for meget end et for lidt.



KOMPRESSIØNSFØRSTØK



148 KOMPRES. FØRSTØK
MÆSSING VA-GODKENDT



150 KOMPRES. FØRSTØK
PLAST VA-GODKENDT



157 KOMPRES. FØRSTØK
PLAST



160 KOMPRES. FØRSTØK MS.
VA-GODK. U/STØTTEBØS.



163 KOMPRES. FØRSTØK MS.
VA-GODK. TIL VAND



166 KOMPRES. FØRSTØK MS.
VA-GODK. TIL VARME



167 INDUSTRIEL
KOMPRES. FØRSTØK

KOMPRESSIONS FITTINGS MESSING VA GODKENDT



Max 16bar



DIN 8074 samt ISO 4437



BETINGELSER FOR MONTERING OG BRUG:
Kompressionskoblinger anvendes i installationer til koldt vand for samling af 20-63mm rør af polyethylen (PE) efter DS 2119, trykklasse PN10. Driftstryk i installationen må ikke overstige 10bar.

Samlinger skal udføres i overensstemmelse med producentens vejledninger. I bygninger skal samlinger være fritliggende eller monteret i udsparinger eller foringsrør, så utætheder er synlige og dele umiddelbart kan udskiftes.

BESKRIVELSE OG TEKNISKE DATA:
Koblingen består af 6 dele: koblingshus, omløber, klemring, trykring og tætningsring samt en støttebøsning.

Koblingen er af messing, tætningsringen af gummi.

Nippel PEL&PEM MESSING - BSPT



Varenr.	dim × BSPT	DKK
072-3460-1	ø20 × 1/2"	60,35
072-3460-2	ø25 × 3/4"	70,40
072-3460-2-1	ø32 × 3/4"	141,00
072-3460-2-2	ø32 × 1"	141,00
072-3460-3-1	ø40 × 1"	145,25
072-3460-4	ø40 × 1 1/4"	246,50
072-3460-5	ø50 × 1 1/2"	383,00
072-3460-6	ø63 × 2"	607,25

Union PEL&PEM MESSING



Varenr.	dim	DKK
072-3461-1	ø20	116,25
072-3461-2	ø25	146,75
072-3461-3	ø32	193,25
072-3461-4	ø40	304,25
072-3461-5	ø50	586,50
072-3461-6	ø63	586,50

Vinkel 90° PEL&PEM/nip MESSING - BSPT



Varenr.	dim × BSPT	DKK
072-3464-1	ø20 × 1/2"	118,00
072-3464-2	ø25 × 3/4"	118,00
072-3464-3	ø32 × 1"	166,00
072-3464-4	ø40 × 1 1/4"	286,75
072-3464-5	ø50 × 1 1/2"	455,25
072-3464-6	ø63 × 2"	455,25

Muffe PEL&PEM MESSING - BSPP



Varenr.	dim × BSPP	DKK
072-3462-1	ø20 × 1/2"	68,55
072-3462-2	ø25 × 3/4"	84,00
072-3462-3	ø32 × 1"	134,50
072-3462-4	ø40 × 1 1/4"	196,00
072-3462-5	ø50 × 1 1/2"	315,50
072-3462-6	ø63 × 2"	428,00

Vinkel 90° PEL&PEM MESSING



Varenr.	dim	DKK
072-3463-1	ø20	119,75
072-3463-2	ø25	166,00
072-3463-3	ø32	230,25
072-3463-4	ø40	564,25
072-3463-5	ø50	598,00
072-3463-6	ø63	598,00

Vinkel 90° PEL&PEM/muf MESSING - BSPP



Varenr.	dim × BSPP	DKK
072-3465-1	ø20 × 1/2"	85,45
072-3465-2	ø25 × 3/4"	119,50
072-3465-3	ø32 × 1"	167,75
072-3465-4	ø40 × 1 1/4"	288,25
072-3465-5	ø50 × 1 1/2"	457,75
072-3465-6	ø63 × 2"	679,25

T-stk PEL&PEM MESSING



Varenr.	dim	DKK
072-3467-1	ø20	170,50
072-3467-2	ø25	285,50
072-3467-3	ø32	302,50
072-3467-4	ø40	521,50
072-3467-5	ø50	492,00
072-3467-6	ø63	492,00

T-stk PEL&PEM/muf gren MESSING - BSPP



Varenr.	dim × BSPP × dim	DKK
072-3469-1	ø20 × 1/2" × ø20	161,00
072-3469-2	ø25 × 3/4" × ø25	170,50
072-3469-3	ø32 × 1" × ø32	161,00
072-3469-4	ø40 × 1 1/4" × ø40	161,00
072-3469-5	ø50 × 1 1/2" × ø50	741,50
072-3469-6	ø63 × 2" × ø63	699,50

Lige kobling lang PEL&PEM MESSING



Varenr.	dim	DKK
072-3471-3	ø32	309,50
072-3471-4	ø40	445,00
072-3471-5	ø50	704,75
072-3471-6	ø63	1009,00

Vinkel 90° PEL&PEM/muf MESSING - BSPP



Med vægbeslag

Varenr.	dim × BSPP	DKK
072-3466-1	ø20 × 1/2"	121,50
072-3466-2	ø25 × 3/4"	161,75
072-3466-3	ø32 × 1"	152,75

Støttebøsning PEL&PEM MESSING



Varenr.	Ø/ø	DKK
072-1475-1	20/14,4	18,45
072-1475-2	25/19	25,70
072-1475-3	32/26	29,15
072-1475-4	40/32,6	43,75
072-1475-5	50/40,8	41,25
072-1475-6	63/51,4	41,25

MESSING KOMPRESSIONSFITTINGS

MONTERING PÅ PE-RØR

- Skær røret vinkelret over og fjern grater
- Løsn omløber (det er unødvendigt at skille muffen ad)
- Marker indstiktsdybden P på rørenden og stik røret ind i muffen til markeringen
- Spænd omløberen i bund

INDSTIKSDYBDE: P

Rør dim.: P mm:
 20mm = 28mm
 25mm = 29mm
 32mm = 33mm
 40mm = 51mm
 50mm = 54mm
 63mm = 56mm

MONTERING PÅ PVC- OG METALRØR

- Skær røret vinkelret over og fjern grater
- Løsn omløber (det er unødvendigt at skille muffen ad)
- Stik røret i bund og træk det derefter 2-3mm tilbage
- Spænd omløberen i bund

VIGTIGT! Hvis samlingen skal være tæt, skal røret skubbes ind forbi O-ringen og omløberen skal spændes i bund.

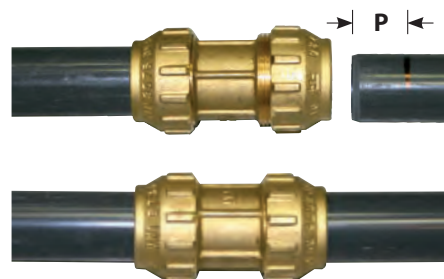

PEM rør 100m PN10 SDR 11 PE (POLYETHYLEN)



100m trykrør i rulle til drikkevandsforsyning. Max 60°C (over 40°C forkortes levetiden).

Varenr.	ø	- -	DKK
070612020	20	2,0	3255,00
070612025	25	2,3	3790,50
070612032	32	2,9	5933,00
070612040	40	3,7	9023,00
070612050	50	4,6	14832,00
070612063	63	5,8	23896,00

Sælges kun i fuld længde.

Leveringstid 1-2 dage.

KOMPRESSIONS FITTINGS PLAST VA GODKENDT



Max 16bar ved 20°C



Max 80°C



VA godkendt til drikkevand



Denne serie er produceret indenfor EU og er VA godkendt med NBR pakninger.

KOMPRESSION FITTINGS

Rør 4m PP (POLYPROPYLEN)

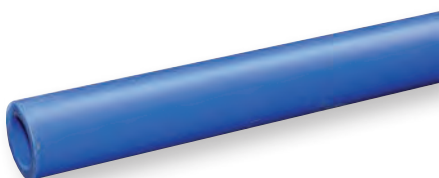

Til aggressive miljøer

Varenr.	Ø/ø	DKK
AJ1-2	20/13,2	65,55
AJ1-3	25/16,6	99,95
AJ1-4	32/21,2	158,50

Sælges kun i hele længder

PLAST KOMPRESSIONSFITTINGS

MONTERING PÅ RØR

- Skær røret vinkelret over og fjern grater
- Løsn omløber (det er unødvendigt at skille muffen ad)
- Stik røret ind til stop i muffen
- Spænd omløberen

VIGTIGT! Hvis samlingen skal være tæt, skal røret skubbes helt ind (forbi O-ringen) og omløberen skal spændes i bund.



Nippel kompres PP (POLYPROPYLEN) - BSPP



Varenr.	dim × BSPT	DKK	Varenr.	Ø × 1/4"	DKK
A60-1	ø16 × 3/8"	17,90	A60-18	ø50 × 11/4"	81,65
A60-2	ø16 × 1/2"	17,90	A60-19	ø50 × 11/2"	77,25
A60-3	ø16 × 3/4"	17,90	A60-20	ø50 × 2"	77,25
A60-4	ø20 × 1/2"	21,75	A60-21	ø63 × 11/4"	104,25
A60-5	ø20 × 3/4"	19,75	A60-22	ø63 × 11/2"	104,25
A60-6	ø20 × 1"	21,75	A60-23	ø63 × 2"	104,25
A60-7	ø25 × 1/2"	24,15	A60-24	ø63 × 2 1/2"	104,25
A60-8	ø25 × 3/4"	24,15	A60-25	ø75 × 2"	206,50
A60-9	ø25 × 1"	24,15	A60-26	ø75 × 2 1/2"	218,00
A60-10	ø32 × 3/4"	32,85	A60-27	ø75 × 3"	206,50
A60-11	ø32 × 1"	30,90	A60-28	ø90 × 2"	269,50
A60-12	ø32 × 1 1/4"	32,85	A60-29	ø90 × 2 1/2"	269,50
A60-13	ø40 × 1"	53,80	A60-30	ø90 × 3"	269,50
A60-14	ø40 × 1 1/4"	53,80	A60-31	ø90 × 4"	269,50
A60-15	ø40 × 1 1/2"	53,80	A60-32	ø110 × 2"	427,75
A60-16	ø40 × 2"	57,35	A60-33	ø110 × 3"	427,75
A60-17	ø50 × 1"	81,65	A60-34	ø110 × 4"	427,75

Muffe kompres

PP (POLYPROPYLEN) - BSPP



Varenr.	dim × BSPP	DKK
A61-1	ø16 × 1/2"	18,45
A61-2	ø16 × 3/4"	18,45
A61-3	ø20 × 1/2"	21,75
A61-4	ø20 × 3/4"	21,75
A61-5	ø20 × 1"	21,75
A61-6	ø25 × 1/2"	28,95
A61-7	ø25 × 3/4"	26,00
A61-8	ø25 × 1"	26,00
A61-9	ø32 × 1/2"	37,00
A61-10	ø32 × 3/4"	33,40
A61-11	ø32 × 1"	33,40
A61-12	ø32 × 1 1/4"	33,40
A61-13	ø40 × 1"	55,45
A61-14	ø40 × 1 1/4"	58,15
A61-15	ø40 × 1 1/2"	58,15
A61-16	ø50 × 1 1/4"	77,85
A61-17	ø50 × 1 1/2"	198,00
A61-18	ø50 × 2"	86,55
A61-19	ø63 × 1 1/4"	122,75
A61-20	ø63 × 1 1/2"	122,75
A61-21	ø63 × 2"	99,95
A61-22	ø63 × 2 1/2"	122,75
A61-23	ø75 × 2"	221,50
A61-24	ø75 × 2 1/2"	221,50
A61-25	ø75 × 3"	254,75
A61-26	ø90 × 2"	280,00
A61-27	ø90 × 2 1/2"	321,75
A61-28	ø90 × 3"	280,00
A61-29	ø90 × 4"	280,00
A61-30	ø110 × 3"	615,25
A61-31	ø110 × 4"	615,25

Union kompres

PP (POLYPROPYLEN)



Varenr.	dim	DKK
A62-1	ø16	19,85
A62-2	ø20	26,50
A62-3	ø25	32,85
A62-4	ø32	51,25
A62-5	ø40	92,55
A62-6	ø50	131,50
A62-7	ø63	169,25
A62-8	ø75	353,00
A62-9	ø90	438,25
A62-10	ø110	896,75

Reparationskobling kompres

PP (POLYPROPYLEN)



Varenr.	dim	DKK
A75-1	ø40	110,00
A75-2	ø50	157,50
A75-3	ø63	192,50
A75-4	ø75	385,00
A75-5	ø90	495,25
A75-6	ø110	974,25

Union kompres reduktion

PP (POLYPROPYLEN)



Varenr.	dim	DKK
A63-1	ø20 × ø16	35,35
A63-2	ø25 × ø20	44,15
A63-3-0	ø32 × ø20	51,25
A63-3	ø32 × ø25	51,25
A63-4	ø40 × ø25	99,70
A63-5	ø40 × ø32	93,90
A63-6	ø50 × ø25	139,50
A63-7	ø50 × ø32	139,50
A63-8	ø50 × ø40	131,50
A63-9	ø63 × ø25	183,50
A63-10	ø63 × ø32	183,50
A63-11	ø63 × ø40	183,50
A63-12	ø63 × ø50	175,00
A63-13	ø75 × ø50	348,25
A63-14	ø75 × ø63	306,75
A63-15	ø90 × ø63	414,00
A63-16	ø90 × ø75	414,00
A63-17	ø110 × ø90	849,25

Adapter kompres

PP (POLYPROPYLEN)



Varenr.	dim	DKK
A79-1	ø25 × 22/15	259,00
A79-2	ø25 × 27/20	288,00
A79-3	ø32 × 27/20	334,00
A79-4	ø25 × 34/27	318,00
A79-5	ø32 × 34/27	318,00

Nippel kompres

PP (POLYPROPYLEN) - BSPP



Varenr.	dim × BSPT	DKK
A80-1	ø20 × 1/2"	218,00
A80-2	ø25 × 3/4"	304,50
A80-3	ø32 × 1"	714,50
A80-4	ø40 × 1 1/4"	969,25
A80-5	ø50 × 1 1/2"	1635,75
A80-6	ø63 × 2"	2115,75

Muffe kompres

PP (POLYPROPYLEN) - BSPP



Varenr.	dim × BSPP	DKK
A81-1	ø20 × 1/2"	192,50
A81-2	ø25 × 3/4"	223,00
A81-3	ø32 × 1"	445,00
A81-4	ø40 × 1 1/4"	753,50
A81-5	ø50 × 1 1/2"	1494,75
A81-6	ø63 × 2"	1906,75

Kompres flangetilslutning

PP (POLYPROPYLEN)



Varenr.	dim × flange	DKK
A74-1	ø40 × 1 1/2"	368,75
A74-2	ø50 × 1 1/2"	368,75
A74-3	ø50 × 2"	368,75
A74-4	ø63 × 2"	368,75
A74-5	ø63 × 2 1/2"	368,75
A74-6	ø75 × 2 1/2"	518,00
A74-7	ø75 × 3"	518,00
A74-8	ø90 × 3"	596,00
A74-9	ø90 × 4"	606,75
A74-10	ø110 × 4"	848,00

Slutmuffe kompres

PP (POLYPROPYLEN)



Varenr.	dim	DKK
A71-1	ø16	24,15
A71-2	ø20	27,15
A71-3	ø25	24,15
A71-4	ø32	30,35
A71-5	ø40	53,30
A71-6	ø50	71,80
A71-7	ø63	101,25
A71-8	ø75	220,25
A71-9	ø90	297,75
A71-10	ø110	602,25

Bøjning 90° kompres

PP (POLYPROPYLEN)



Varenr.	dim	DKK
A64-1	ø16	28,95
A64-2	ø20	35,35
A64-3	ø25	41,95
A64-4	ø32	51,25
A64-5	ø40	95,80
A64-6	ø50	127,75
A64-7	ø63	173,00
A64-8	ø75	329,00
A64-9	ø90	443,25
A64-10	ø110	896,75

Bøjning 90° kompres/nippel

PP (POLYPROPYLEN) - BSPP



Varenr.	dim × BSPT	DKK
A66-1	ø16 × 1/2"	42,75
A66-2	ø16 × 3/4"	27,15
A66-3	ø20 × 1/2"	27,15
A66-4	ø20 × 3/4"	27,15
A66-5	ø25 × 1/2"	33,90
A66-6	ø25 × 3/4"	38,10
A66-7	ø25 × 1"	48,85
A66-8	ø32 × 1/2"	48,85
A66-9	ø32 × 3/4"	45,50
A66-10	ø32 × 1"	39,40
A66-11	ø32 × 1 1/4"	45,50
A66-12	ø40 × 1"	64,45
A66-13	ø40 × 1 1/4"	64,45
A66-14	ø40 × 1 1/2"	64,45
A66-15	ø50 × 1 1/4"	92,55
A66-16	ø50 × 1 1/2"	92,55
A66-17	ø50 × 2"	106,25
A66-18	ø63 × 1 1/2"	149,25
A66-19	ø63 × 2"	130,50
A66-20	ø63 × 2 1/2"	149,25
A66-21	ø75 × 2 1/2"	240,00
A66-22	ø75 × 3"	240,00
A66-23	ø90 × 3"	373,00
A66-24	ø90 × 4"	513,50
A66-25	ø110 × 3"	513,50
A66-26	ø110 × 4"	814,50

Bøjning 90° kompres/muffe

PP (POLYPROPYLEN) - BSPP



Varenr.	dim × BSPP	DKK
A65-1	ø16 × 1/2"	21,75
A65-2	ø16 × 3/4"	21,75
A65-3	ø20 × 1/2"	27,15
A65-4	ø20 × 3/4"	27,15
A65-5	ø25 × 1/2"	41,45
A65-6	ø25 × 3/4"	35,35
A65-7	ø25 × 1"	35,35
A65-8	ø32 × 1/2"	50,75
A65-9	ø32 × 3/4"	44,40
A65-10	ø32 × 1"	44,40
A65-11	ø32 × 1 1/4"	44,40
A65-12	ø40 × 3/4"	87,10
A65-13	ø40 × 1"	81,40
A65-14	ø40 × 1 1/4"	81,40
A65-15	ø40 × 1 1/2"	81,40
A65-16	ø50 × 1 1/4"	108,00
A65-17	ø50 × 1 1/2"	108,00
A65-18	ø50 × 2"	108,00
A65-19	ø63 × 1 1/2"	165,50
A65-20	ø63 × 2"	142,75
A65-21	ø63 × 2 1/2"	165,50
A65-22	ø75 × 2"	254,25
A65-23	ø75 × 2 1/2"	254,25
A65-24	ø75 × 3"	254,25
A65-25	ø90 × 3"	532,00
A65-26	ø90 × 4"	532,00
A65-27	ø110 × 3"	814,50
A65-28	ø110 × 4"	814,50

Vinkel 90° kompres/muffe

PP (POLYPROPYLEN) - BSPP



Med beslag

Varenr.	dim × BSPP	DKK
A76-1	ø20 × 1/2"	45,50
A76-2	ø25 × 3/4"	62,30

T-stk kompres

PP (POLYPROPYLEN)



Varenr.	dim	DKK
A67-1	ø16	40,25
A67-2	ø20	49,35
A67-3	ø25	62,00
A67-4	ø32	80,25
A67-5	ø40	141,75
A67-6	ø50	191,00
A67-7	ø63	262,25
A67-8	ø75	494,25
A67-9	ø90	685,00
A67-10	ø110	1464,75

T-stk kompres reduktion

PP (POLYPROPYLEN)



Varenr.	dim	DKK
A68-1	ø20 × ø16 × ø20	72,90
A68-2	ø25 × ø20 × ø25	68,00
A68-3	ø32 × ø20 × ø32	90,10
A68-4	ø32 × ø25 × ø32	90,10
A68-5	ø40 × ø25 × ø40	156,25
A68-6	ø40 × ø32 × ø40	145,50
A68-7	ø50 × ø25 × ø50	197,00
A68-8	ø50 × ø32 × ø50	197,00
A68-9	ø50 × ø40 × ø50	197,00
A68-10	ø63 × ø25 × ø63	269,00
A68-11	ø63 × ø32 × ø63	269,00
A68-12	ø63 × ø50 × ø63	1843,75
A68-13	ø75 × ø63 × ø75	492,50
A68-14	ø90 × ø63 × ø90	492,50
A68-15	ø90 × ø75 × ø90	801,00
A68-16	ø110 × ø90 × ø110	1430,75

T-stk kompres/nippel gren

PP (POLYPROPYLEN) - BSPP



Varenr.	dim × BSPP × dim	DKK
A69-1	ø16 × 1/2" × ø16	59,80
A69-2	ø16 × 3/4" × ø16	39,75
A69-3	ø20 × 1/2" × ø20	41,95
A69-4	ø20 × 3/4" × ø20	41,95
A69-5	ø25 × 1/2" × ø25	50,75
A69-6	ø25 × 3/4" × ø25	50,75
A69-7	ø25 × 1" × ø25	54,05
A69-8	ø32 × 1/2" × ø32	68,25
A69-9	ø32 × 3/4" × ø32	68,25
A69-10	ø32 × 1" × ø32	59,80
A69-11	ø32 × 1 1/4" × ø32	68,25
A69-12	ø40 × 1" × ø40	136,50
A69-13	ø40 × 1 1/4" × ø40	118,25
A69-14	ø40 × 1 1/2" × ø40	118,25
A69-15	ø50 × 1 1/4" × ø50	178,25
A69-16	ø50 × 1 1/2" × ø50	155,25
A69-17	ø50 × 2" × ø50	178,25
A69-18	ø63 × 1 1/2" × ø63	350,25
A69-19	ø63 × 2" × ø63	305,50
A69-20	ø63 × 2 1/2" × ø63	350,25
A69-21	ø75 × 2 1/2" × ø75	406,50
A69-22	ø75 × 3" × ø75	406,50
A69-23	ø90 × 3" × ø90	909,25
A69-24	ø90 × 4" × ø90	909,25
A69-25	ø110 × 4" × ø110	1172,25

T-stk kompres/muffe gren

PP (POLYPROPYLEN) - BSPP



Varenr.	dim × BSPP × dim	DKK
A70-1	ø16 × 1/2" × ø16	28,95
A70-2	ø16 × 3/4" × ø16	28,95
A70-3	ø20 × 1/2" × ø20	40,25
A70-4	ø20 × 3/4" × ø20	40,25
A70-5	ø25 × 1/2" × ø25	50,75
A70-6	ø25 × 3/4" × ø25	50,75
A70-7	ø25 × 1" × ø25	50,75
A70-8	ø32 × 1/2" × ø32	72,90
A70-9	ø32 × 3/4" × ø32	63,90
A70-10	ø32 × 1" × ø32	63,90
A70-11	ø32 × 1 1/4" × ø32	89,00
A70-12	ø40 × 1" × ø40	120,00
A70-13	ø40 × 1 1/4" × ø40	127,75
A70-14	ø40 × 1 1/2" × ø40	112,75
A70-15	ø50 × 1 1/4" × ø50	182,75
A70-16	ø50 × 1 1/2" × ø50	151,00
A70-17	ø50 × 2" × ø50	159,75
A70-18	ø63 × 1 1/4" × ø63	219,00
A70-19	ø63 × 1 1/2" × ø63	207,00
A70-20	ø63 × 2" × ø63	207,00
A70-21	ø63 × 2 1/2" × ø63	297,75
A70-22	ø75 × 2" × ø75	417,00
A70-23	ø75 × 2 1/2" × ø75	383,25
A70-24	ø75 × 3" × ø75	383,25
A70-25	ø90 × 2 1/2" × ø90	1026,75
A70-26	ø90 × 3" × ø90	893,25
A70-27	ø90 × 4" × ø90	893,25
A70-28	ø110 × 3" × ø110	1337,00
A70-29	ø110 × 4" × ø110	1164,00

T-stk kompres/muffe gren

PP (POLYPROPYLEN) - BSPP



Med 3/4" befæstelsesgevind

Varenr.	dim × BSPP × dim	DKK
A78-1	ø32 × 3/4" × ø32	80,55

Omløber kompres

PP (POLYPROPYLEN)



Varenr.	dim	DKK
A82-1	ø16	8,05
A82-2	ø20	9,90
A82-3	ø25	11,10
A82-4	ø32	15,00
A82-5	ø40	27,15
A82-6	ø50	33,40
A82-7	ø63	55,45
A82-8	ø75	106,25
A82-9	ø90	258,75
A82-10	ø110	340,75

Kompres O-ring/pakning

NBR



Varenr.	dim	DKK
A83-1	ø16	5,15
A83-2	ø20	5,70
A83-3	ø25	8,75
A83-4	ø32	9,30
A83-5	ø40	14,35
A83-6	ø50	16,65
A83-7	ø63	36,45
A83-8	ø75	30,10
A83-9	ø90	41,10
A83-10	ø110	51,25

Kompresring forrest

POM (ACETAL)



Varenr.	dim	DKK
A84-1	ø16	4,19
A84-2	ø20	5,70
A84-3	ø25	6,35
A84-4	ø32	9,90
A84-5	ø40	14,35
A84-6	ø50	22,95
A84-7	ø63	33,90
A84-8	ø75	49,10
A84-9	ø90	64,45
A84-10	ø110	94,75

Kompresring bagest

PP (POLYPROPYLEN)



Varenr.	dim	DKK
A85-1	ø16	3,58
A85-2	ø20	4,19
A85-3	ø25	5,15
A85-4	ø32	7,55
A85-5	ø40	13,35
A85-6	ø50	16,65
A85-7	ø63	27,60
A85-8	ø75	67,75
A85-9	ø90	87,65
A85-10	ø110	116,50

Nøgle til PP fittings



Varenr.	dim	Mat.	DKK
A86-1	16-63	PP	97,45
A86-2	63-110	POM	443,25

Saddel-T m. muffe
PP (POLYPROPYLEN) - BSPP



Varenr.	dim × BSPP	Bolte	DKK				
A72-1	ø25 × 1/2"	2	34,50	A72-38	ø125 × 1"	6	112,75
A72-2	ø25 × 3/4"	2	36,45	A72-39	ø125 × 1 1/4"	6	112,75
A72-3	ø32 × 1/2"	2	37,50	A72-40	ø125 × 1 1/2"	6	112,75
A72-4	ø32 × 3/4"	2	37,50	A72-41	ø125 × 2"	6	112,75
A72-5	ø32 × 1"	2	37,50	A72-42	ø125 × 3"	6	112,75
A72-6	ø40 × 1/2"	2	39,75	A72-43	ø140 × 1"	6	216,50
A72-7	ø40 × 3/4"	2	39,75	A72-44	ø140 × 1 1/4"	6	216,50
A72-8	ø40 × 1"	2	39,75	A72-45	ø140 × 1 1/2"	6	216,50
A72-9	ø50 × 1/2"	4	42,75	A72-46	ø140 × 2"	6	216,50
A72-10	ø50 × 3/4"	4	42,75	A72-47	ø140 × 3"	6	216,50
A72-11	ø50 × 1"	4	42,75	A72-48	ø160 × 1"	6	274,00
A72-12	ø50 × 1 1/4"	4	42,75	A72-49	ø160 × 1 1/4"	6	274,00
A72-13	ø63 × 1/2"	4	54,85	A72-50	ø160 × 1 1/2"	6	274,00
A72-14	ø63 × 3/4"	4	54,85	A72-51	ø160 × 2"	6	274,00
A72-15	ø63 × 1"	4	54,85	A72-52	ø160 × 3"	6	274,00
A72-16	ø63 × 1 1/4"	4	54,85	A72-53	ø160 × 4"	6	274,00
A72-17	ø63 × 1 1/2"	4	54,85	A72-54	ø200 × 1"	6	951,75
A72-18	ø75 × 1/2"	4	101,00	A72-55	ø200 × 1 1/4"	6	951,75
A72-19	ø75 × 3/4"	4	189,75	A72-56	ø200 × 1 1/2"	6	951,75
A72-20	ø75 × 1"	4	70,45	A72-57	ø200 × 2"	6	951,75
A72-21	ø75 × 1 1/4"	4	70,45	A72-58	ø200 × 2 1/2"	6	951,75
A72-22	ø75 × 1 1/2"	4	70,45	A72-59	ø200 × 3"	6	951,75
A72-23	ø75 × 2"	4	70,45	A72-60	ø200 × 4"	6	951,75
A72-24	ø90 × 1/2"	4	79,75	A72-61	ø225 × 1 1/4"	6	1139,25
A72-25	ø90 × 3/4"	4	79,75	A72-62	ø225 × 2"	6	1139,25
A72-26	ø90 × 1"	4	79,75	A72-63	ø225 × 3"	6	1139,25
A72-27	ø90 × 1 1/4"	4	79,75	A72-64	ø225 × 4"	6	1139,25
A72-28	ø90 × 1 1/2"	4	79,75	A72-65	ø250 × 1 1/4"	6	1348,50
A72-29	ø90 × 2"	4	79,75	A72-66	ø250 × 1 1/2"	6	1348,50
A72-30	ø110 × 1/2"	4	90,10	A72-67	ø250 × 2"	6	1348,50
A72-31	ø110 × 3/4"	4	90,10	A72-68	ø250 × 3"	6	1348,50
A72-32	ø110 × 1"	4	90,10	A72-69	ø250 × 4"	6	1348,50
A72-33	ø110 × 1 1/4"	4	90,10	A72-70	ø315 × 1 1/4"	6	1687,25
A72-34	ø110 × 1 1/2"	4	90,10	A72-71	ø315 × 1 1/2"	6	1687,25
A72-35	ø110 × 2"	4	90,10	A72-72	ø315 × 2"	6	1687,25
A72-36	ø125 × 1/2"	6	112,75	A72-73	ø315 × 3"	6	1687,25
A72-37	ø125 × 3/4"	6	112,75	A72-74	ø315 × 4"	6	1687,25

Saddel-T m. 2 muffer

PP (POLYPROPYLEN) - BSPP



KOMPRESION FITTINGS

Varenr.	dim × BSPP	Bolte	DKK				
A73-1	ø25 × 1/2"	2	41,45	A73-25	ø90 × 3/4"	4	112,25
A73-2	ø25 × 3/4"	2	41,45	A73-26	ø90 × 1"	4	112,25
A73-3	ø32 × 1/2"	2	51,25	A73-27	ø90 × 1 1/4"	4	112,25
A73-4	ø32 × 3/4"	2	51,25	A73-28	ø90 × 1 1/2"	4	112,25
A73-5	ø32 × 1"	2	51,25	A73-29	ø90 × 2"	4	112,25
A73-6	ø40 × 2:1/2"	2	60,35	A73-30	ø110 × 1/2"	4	150,50
A73-7	ø40 × 3/4"	2	60,35	A73-31	ø110 × 3/4"	4	150,50
A73-8	ø40 × 1"	2	60,35	A73-32	ø110 × 1"	4	150,50
A73-9	ø50 × 1/2"	4	65,55	A73-33	ø110 × 1 1/4"	4	150,50
A73-10	ø50 × 3/4"	4	65,55	A73-34	ø110 × 1 1/2"	4	150,50
A73-11	ø50 × 1"	4	65,55	A73-35	ø110 × 2"	4	150,50
A73-12	ø50 × 1 1/4"	4	65,55	A73-36	ø125 × 1/2"	6	182,75
A73-13	ø63 × 1/2"	4	78,90	A73-37	ø125 × 3/4"	6	182,75
A73-14	ø63 × 3/4"	4	78,90	A73-38	ø125 × 1"	6	182,75
A73-15	ø63 × 1"	4	78,90	A73-39	ø125 × 1 1/4"	6	182,75
A73-16	ø63 × 1 1/4"	4	78,90	A73-40	ø125 × 1 1/2"	6	182,75
A73-17	ø63 × 1 1/2"	4	78,90	A73-41	ø125 × 2"	6	182,75
A73-18	ø75 × 1/2"	4	103,75	A73-42	ø140 × 1"	6	260,50
A73-19	ø75 × 3/4"	4	103,75	A73-43	ø140 × 1 1/4"	6	260,50
A73-20	ø75 × 1"	4	103,75	A73-44	ø140 × 1 1/2"	6	260,50
A73-21	ø75 × 1 1/4"	4	103,75	A73-45	ø140 × 2"	6	260,50
A73-22	ø75 × 1 1/2"	4	103,75	A73-46	ø160 × 1"	6	340,75
A73-23	ø75 × 2"	4	103,75	A73-47	ø160 × 1 1/4"	6	340,75
A73-24	ø90 × 1/2"	4	112,25	A73-48	ø160 × 1 1/2"	6	340,75
				A73-49	ø160 × 2"	6	340,75

KOMPRESION FITTINGS PLAST



Max 16bar ved 20°C



Max 80°C



Serien er IKKE VA-godkendt og kan dermed ikke bruges til drikkevand. Særlig velegnet til agro samt normal industri- vand.



1. Skær røret over med en god rørskærer. Fjern grater fra rørenden.



3. Løsn omløberen 2-3 gevind og indsæt røret i den korrekte dybde.



5. Omløberen er korrekt fastgjort, når den dækker gevindet fuldstændigt.



2. Marker indstiksybden på røret.



4. Op til 32mm kan du ved hjælp af håndkraft skrue omløberen fast. Over 32mm bruges eksempelvis en rem eller en nøgle (A86) til at stramme med.

- 1 PP krop
- 2 NBR O-ring
- 3 PP holder
- 4 Acetal kompressionsring
- 5 PP omløber

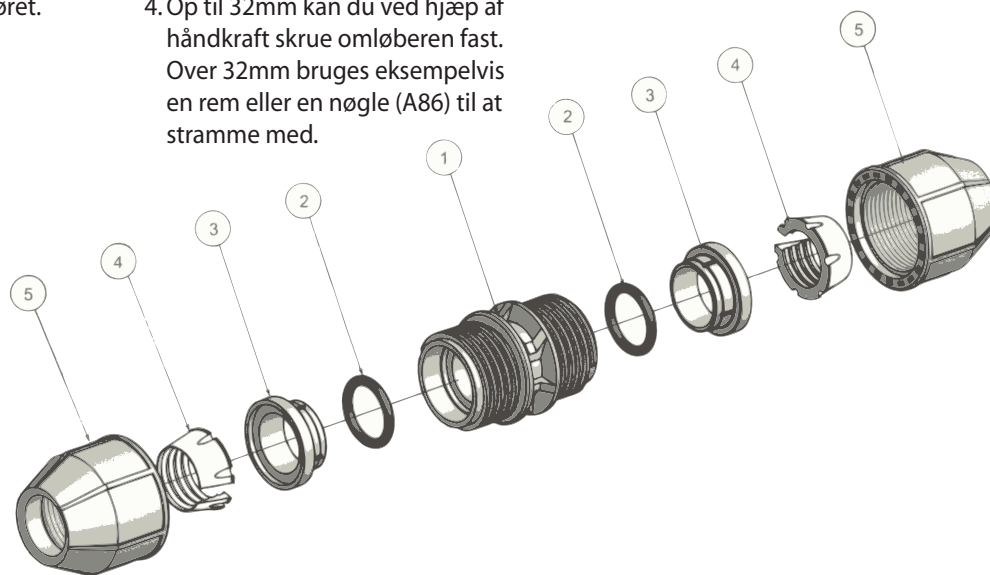

Nippel kompres PP (POLYPROPYLEN) - BSPP



Varenr.	dim × BSPP	DKK
AM60-2	ø20 × 1/2"	9,85
AM60-3	ø20 × 3/4"	9,85
AM60-4	ø25 × 1/2"	10,95
AM60-5	ø25 × 3/4"	14,40
AM60-6	ø25 × 1"	14,40
AM60-7	ø32 × 3/4"	20,70
AM60-8	ø32 × 1"	21,10
AM60-10	ø40 × 1"	39,40
AM60-11	ø40 × 1 1/4"	40,35
AM60-12	ø40 × 1 1/2"	40,35

Union kompres PP (POLYPROPYLEN)



Varenr.	dim	DKK
AM62-2	ø20	15,25
AM62-3	ø25	22,90
AM62-4	ø32	34,55
AM62-5	ø40	60,05



Vinkel 90° kompres PP (POLYPROPYLEN)



Varenr.	dim	DKK
AM64-2	ø20	15,85
AM64-3	ø25	24,65
AM64-4	ø32	35,85
AM64-5	ø40	64,55

Vinkel 90° kompres/nippel PP (POLYPROPYLEN) - BSPP



Varenr.	dim × BSPP	DKK
AM66-1	ø20 × 1/2"	12,60
AM66-1-5	ø20 × 3/4"	11,25
AM66-2	ø25 × 1/2"	15,25
AM66-3	ø25 × 3/4"	15,25
AM66-3-6	ø25 × 1"	15,25
AM66-4	ø32 × 3/4"	21,55
AM66-5	ø32 × 1"	21,55
AM66-6	ø40 × 1 1/4"	41,20
AM66-6-1	ø40 × 1 1/2"	41,70

Muffe kompres PP (POLYPROPYLEN) - BSPP



Varenr.	dim × BSPP	DKK
AM61-2	ø20 × 1/2"	10,10
AM61-3	ø20 × 3/4"	10,80
AM61-4	ø25 × 1/2"	11,75
AM61-5	ø25 × 3/4"	12,60
AM61-6	ø25 × 1"	15,95
AM61-7	ø32 × 3/4"	21,55
AM61-8	ø32 × 1"	22,90
AM61-9	ø40 × 1"	39,95
AM61-10	ø40 × 1 1/4"	39,95
AM61-11	ø40 × 1 1/2"	39,95
AM61-13	ø75 × 2 1/2"	191,25 α

α = så længe lager havs

Kobling kompres reduktion PP (POLYPROPYLEN)



Varenr.	dim	DKK
AM63-2	ø25 × ø20	19,30
AM63-3	ø32 × ø20	25,55
AM63-4	ø32 × ø25	31,70
AM63-6	ø40 × ø32	83,30 α
AM63-9	ø63 × ø40	271,50 α
AM63-10	ø63 × ø50	590,50 α

α = så længe lager havs

Slutmuffe kompres PP (POLYPROPYLEN)



Varenr.	dim	DKK
AM71-2	ø20	9,85
AM71-3	ø25	15,25
AM71-4	ø32	21,55
AM71-5	ø40	33,60
AM71-9	ø90	159,25 α

α = så længe lager havs

Vinkel 90° kompres/muffe PP (POLYPROPYLEN) - BSPP



Varenr.	dim × BSPP	DKK
AM65-2	ø20 × 1/2"	12,15
AM65-2-5	ø20 × 3/4"	12,60
AM65-3	ø25 × 1/2"	13,00
AM65-4	ø25 × 3/4"	17,05
AM65-4-6	ø25 × 1"	17,05
AM65-5	ø32 × 3/4"	22,45
AM65-6	ø32 × 1"	24,25
AM65-7	ø40 × 1"	41,70
AM65-8	ø40 × 1 1/4"	42,35

Vinkel 90° kompres/muffe

PP (POLYPROPYLEN) - BSPP



Med beslag

Varenr.	dim × BSPP	DKK
AM76-1	ø20 × 1/2"	18,40
AM76-2	ø25 × 3/4"	28,85

T-stk kompres

PP (POLYPROPYLEN)



Varenr.	dim	DKK
AM67-2	ø20	26,05
AM67-3	ø25	34,95
AM67-4	ø32	53,80
AM67-5	ø40	93,65

T-stk kompres reduktion

PP (POLYPROPYLEN)



Varenr.	dim	DKK
AM68-1	ø25×20×25	48,45
AM68-2	ø32×25×32	48,45

T-stk kompres/nippel gren

PP (POLYPROPYLEN) - BSPP



Varenr.	dim × BSPP × dim	DKK
AM69-1	ø20 × 1/2" × ø20	21,55
AM69-1-5	ø20 × 3/4" × ø20	18,40
AM69-2	ø25 × 3/4" × ø25	26,95
AM69-2-4	ø25 × 1/2" × ø25	26,95
AM69-2-6	ø25 × 1" × ø25	29,65
AM69-3	ø32 × 1" × ø32	39,90
AM69-3-5	ø32 × 3/4" × ø32	39,90
AM69-4	ø40 × 1 1/4" × ø40	71,25
AM69-5	ø50 × 1 1/2" × ø50	99,35 α

α = så længe lager haves

T-stk kompres/muffe gren

PP (POLYPROPYLEN) - BSPP



Varenr.	dim × BSPP × dim	DKK
AM70-2	ø20 × 1/2" × ø20	22,45
AM70-2-5	ø20 × 3/4" × ø20	22,45
AM70-3	ø25 × 1/2" × ø25	25,55
AM70-4	ø25 × 3/4" × ø25	26,45
AM70-5	ø32 × 3/4" × ø32	42,60
AM70-6	ø32 × 1" × ø32	43,50
AM70-7	ø40 × 1" × ø40	132,25
AM70-8	ø40 × 1 1/4" × ø40	131,50
AM70-11	ø75 × 2 1/2" × ø75	345,75 α
AM70-12	ø90 × 3" × ø90	345,75 α

α = så længe lager haves

KOMPRESSION FITTINGS MESSING VA-GODKENDT UDEN STØTTEBØSNING



Messing kompressionsfittings, bredt program til brug i industrien.

Max tryk: 10 bar

KOMPRESSION FITTINGS

Nippel kompres MESSING - BSPT



Varenr.	ø × BSPT	DKK
044060107	08 × 1/4"	32,20
044060108	08 × 3/8"	33,30
044060116	10 × 3/8"	27,65
044060118	10 × 1/2"	31,25
044060012	12 × 3/8"	27,65
044060132	12 × 1/2"	31,25
044060166	15 × 3/8"	35,60
044060015	15 × 1/2"	34,20
044060176	15 × 3/4"	60,05
044060222	18 × 1/2"	51,10
044060232	18 × 3/4"	64,95
044060263	22 × 1/2"	68,00
044060022	22 × 3/4"	66,10
044060291	22 × 1"	87,65
044060339	28 × 3/4"	96,10
044060028	28 × 1"	101,25
044060035	35 × 1 1/4"	256,75
044060042	42 × 1 1/2"	308,50
044060054	54 × 2"	549,25

Muffe kompres MESSING - BSPP



Varenr.	ø × BSPP	DKK
044065116	10 × 3/8"	37,30
044065118	10 × 1/2"	41,55
044065012	12 × 3/8"	43,70
044065132	12 × 1/2"	41,20
044065166	15 × 3/8"	46,50
044065015	15 × 1/2"	44,55
044065176	15 × 3/4"	55,10
044065222	18 × 1/2"	57,35
044065232	18 × 3/4"	65,55
044065263	22 × 1/2"	67,20
044065022	22 × 3/4"	68,50
044065291	22 × 1"	88,45
044065339	28 × 3/4"	117,75
044065028	28 × 1"	93,65
044065032	35 × 1 1/4"	224,75
044065042	42 × 1 1/2"	319,25
044065054	54 × 2"	560,25

Union kompres MESSING



Varenr.	ø	DKK
044070008	8	47,00
044070010	10	34,40
044070012	12	38,30
044070015	15	50,05
044070018	18	65,55
044070022	22	85,45
044070028	28	128,75
044070035	35	316,75
044070042	42	386,75
044070054	54	628,50

Union kompres red. MESSING



Varenr.	ø	DKK
044070113	10×08	42,70
044070127	12×10	38,15
044070162	15×08	57,60
044070164	15×10	47,45
044070166	15×12	49,15
044070216	18×12	81,10
044070222	18×15	79,75
044070263	22×15	89,00
044070272	22×18	100,50
044070339	28×22	137,00

Vinkel 90° kompres

MESSING



Varenr.	ø	DKK
044020010	10	46,10
044020012	12	46,65
044020166	15 × 12	61,70
044020015	15	57,35
044020222	18 × 15	92,55
044020018	18	82,50
044020022	22	93,40
044020028	28	137,75
044020035	35	331,25
044020042	42	444,25

Vinkel 90° kompres/nip

MESSING - BSPT



Varenr.	ø × BSPT	DKK
044021108	10 × 3/8"	80,55
044021118	10 × 1/2"	59,50
044021012	12 × 3/8"	56,00
044021132	12 × 1/2"	57,35
044021166	15 × 3/8"	59,00
044021015	15 × 1/2"	55,70
044021176	15 × 3/4"	96,40
044021222	18 × 1/2"	86,55
044021232	18 × 3/4"	91,75
044021263	22 × 1/2"	96,95
044021022	22 × 3/4"	84,10
044021291	22 × 1"	156,50
044021339	28 × 3/4"	152,00
044021028	28 × 1"	132,50
044021035	35 × 1 1/4"	345,25
044021042	42 × 1 1/2"	413,50

Vinkel 90° kompres/muf

MESSING - BSPP



Varenr.	ø × BSPP	DKK
044023116	10 × 3/8"	83,80
044023118	10 × 1/2"	56,85
044023012	12 × 3/8"	80,55
044023132	12 × 1/2"	47,15
044023166	15 × 3/8"	62,55
044023015	15 × 1/2"	56,25
044023176	15 × 3/4"	107,75
044023222	18 × 1/2"	84,40
044023232	18 × 3/4"	99,95
044023263	22 × 1/2"	128,25
044023022	22 × 3/4"	92,55
044023291	22 × 1"	139,50
044023339	28 × 3/4"	167,50
044023028	28 × 1"	132,00
044023035	35 × 1 1/4"	293,00
044023042	42 × 1 1/2"	417,00
044023054	54 × 2"	914,75

Vinkel 90° kompres/muf

MESSING - BSPP



Med vægbeslag

Varenr.	ø × BSPP	DKK
044163132	12 × 1/2"	92,55
044163015	15 × 1/2"	90,65
044163222	18 × 1/2"	108,25
044163022	22 × 3/4"	165,75

T-stk kompres

MESSING



Varenr.	ø	DKK
044030008	8	83,00
044030010	10	69,65
044030012	12	64,20
044030015	15	79,20
044030018	18	113,75
044030022	22	127,75
044030028	28	186,00
044030035	35	397,00
044030042	42	529,25
044030054	54	834,75

T-stk kompres red.

MESSING



Varenr.	ø	DKK
044030132	12 × 15 × 12	92,55
044030165	15 × 12 × 12	92,25
044030166	15 × 12 × 15	92,25
044030169	15 × 15 × 12	99,10
044030176	15 × 22 × 15	134,25
044030221	18 × 15 × 15	134,25
044030222	18 × 15 × 18	134,25
044030262	22 × 15 × 15	137,75
044030263	22 × 15 × 22	133,00
044030278	22 × 22 × 15	130,00
044030281	22 × 22 × 18	147,50
044030339	28 × 22 × 28	185,75

T-stk kompres/muf gren

MESSING - BSPP



Varenr.	ø × BSPP × ø	DKK
044037022	22 × 3/4" × 22	164,75
044037035	35 × 1 1/4" × 35	423,50
044037042	42 × 1 1/2" × 42	539,50
044037222	15 × 1/2" × 15	114,00
044037232	18 × 1/2" × 18	127,25
044037263	22 × 1/2" × 22	167,50
044037339	28 × 3/4" × 28	178,25

Kryds kompres

MESSING

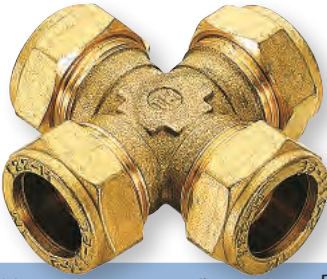

Varenr.	ø	DKK
044040015	15	167,00
044040263	22×15×22×15	331,00

Slutmuffe kompres

MESSING



Varenr.	ø	DKK
044080010	10	27,15
044080012	12	20,75
044080015	15	29,00
044080018	18	50,05
044080022	22	46,80
044080028	28	77,55

Omløber kompres

MESSING

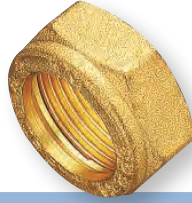

Varenr.	Ø	DKK
044095008	8	10,00
044095010	10	9,50
044095012	12	9,50
044095015	15	11,05
044095018	18	14,20
044095022	22	15,45
044095028	28	23,05
044095035	35	67,20
044095042	42	80,00
044095054	54	143,75

Kompres konusring

MESSING



Varenr.	ø	DKK
044096008	8	6,80
044096010	10	4,25
044096012	12	4,59
044096015	15	5,15
044096018	18	5,45
044096022	22	6,80
044096028	28	8,50
044096035	35	18,85
044096042	42	26,00
044096054	54	31,75

Bøsning reduktion

MESSING



Varenr.	ø	DKK
044054125	12 × 08	83,30
044054127	12 × 10	18,85
044054162	15 × 08	29,70
044054164	15 × 10	25,75
044054166	15 × 12	21,60
044054216	18 × 12	39,15
044054222	18 × 15	31,90
044054258	22 × 12	34,40
044054263	22 × 15	25,45
044054272	22 × 18	41,20
044054324	28 × 15	39,30
044054339	28 × 22	41,60

Støttebøsning

MESSING



Varenr.	Ø1	Ø2	DKK
044093008	6	8	10,60
044093010	8	10	10,60
044093012	10	12	9,85
044093015	13	15	9,85
044093018	16	18	13,60

Ø1 = hylse udvendigt, Ø2 = krave udvendigt

Støttebøsning

MESSING



Varenr.	Ø1	Ø2	DKK
044094012	12	16	7,20
044094015	15	20	6,85
044094018	18	23	8,05
044094022	22	28	12,65
044094028	28	36	21,40

Ø1 = hylse udvendigt, Ø2 = krave udvendigt

KOMPRESION FITTINGS MESSING VA GODKENDT TIL VAND



Max. 30bar
(fittings m. pakning: 10bar)



-20°C til 200°C
(fittings m. pakning: 110°C)



Kompressionskoblinger anvendes til samling af PEX-rør i brugsvandsinstallationer. Driftstryk i installationen må ikke overstige 1000 kPa.

Samlinger skal udføres i overensstemmelse med producentens vejledninger. I bygninger skal samlinger være fritliggende eller monteret i udsparinger eller foringsrør, så utætheder er synlige og dele umiddelbart kan udskiftes.

Nippel kompres MESSING - BSPT



Varenr.	Ø/ø × BSPT	DKK
045160012	12/8 × 3/8"	16,45 ₺
045160132	12/8 × 1/2"	10,95 ₺
045160166	15/10 × 3/8"	13,85 ₺
045160176	15/10 × 3/4"	17,85 ₺
045160016	16/12 × 1/2"	8,40 ₺
045160239-1	20/16 × 1/2"	18,10 ₺
045160022	22/16 × 3/4"	17,55 ₺
045160315	25/18 × 1"	36,60 ₺
045160339	28/20 × 3/4"	58,95 ₺
045160032	32/26 × 1 1/4"	78,35 ₺

₺ = så længe lager haves

Muffe kompres MESSING - BSPP



Varenr.	Ø/ø × BSPP	DKK
045165132	12/8 × 1/2"	14,15 ₺
045165166	15/10 × 3/8"	9,45 ₺
045165052	16/12 × 3/4"	11,75 ₺
045165222	18/14 × 1/2"	11,55 ₺
045165246-1	20/16 × 3/4"	21,50 ₺
045165263	22/16 × 1/2"	23,70 ₺
045165022	22/16 × 3/4"	19,25 ₺
045165022-1	22/16 × 3/4"	17,45 ₺
045165310	25/18 × 3/4"	28,00 ₺
045165028	28/20 × 1"	52,95 ₺
045165062	32/26 × 3/4"	49,15 ₺
045165032	32/23 × 1"	54,75 ₺
045165063	32/26 × 1"	52,60 ₺

₺ = så længe lager haves

Union kompres MESSING



Varenr.	Ø/ø	DKK
045170012	12/8	18,90 ₺
045170015	15/10	18,90 ₺
045170016	16/12	11,95 ₺
045170018	18/13	20,20 ₺
045170022	22/16	35,20 ₺
045170263	22/16 × 15/10	38,50 ₺
045170272	22/16 × 18/13	38,50 ₺
045170025	25/20	44,00 ₺
045170028	28/20	68,45 ₺
045170032	32/26	59,15 ₺

₺ = så længe lager haves

Vinkel 90° kompres MESSING



Varenr.	Ø/ø	DKK
045120012	12/8	27,55 ₺
045120015	15/10	21,95 ₺
045120018	18/13	29,70 ₺
045120263	22/16 × 15/10	45,85 ₺
045120028	28/20	88,40 ₺

₺ = så længe lager haves

Vinkel 90° kompres/nip

MESSING - BSPT



Varenr.	Ø/ø × BSPT	DKK
045121132	12/8 × 1/2"	19,85 ₺
045121015	15/10 × 1/2"	17,55 ₺
045121176	15/10 × 3/4"	23,30 ₺
045121232	18/13 × 3/4"	27,80 ₺
045121022	22/16 × 3/4"	55,95 ₺
045121028	28/20 × 1"	64,30 ₺
045121382	32/23 × 1"	88,10 ₺

₺ = så længe lager haves

Vinkel 90° kompres/muf

MESSING - BSPP



Varenr.	Ø/ø × BSPP	DKK
045123132	12/8 × 1/2"	17,55 ₺
045123015	15/10 × 1/2"	15,95 ₺
045123176	15/10 × 3/4"	29,70 ₺
045123222	18/13 × 1/2"	21,15 ₺
045123022	22/16 × 3/4"	30,55 ₺
045123028	28/20 × 1"	58,95 ₺
045123382	32/23 × 1"	84,70 ₺

₺ = så længe lager haves

Vinkel 90° kompres/muf

MESSING - BSPP

MESSING - BSPP

UDGÅET

T-stk kompres

MESSING



Varenr.	Ø/ø	DKK
045130012	12/8	34,70 ₺
045130015	15/10	26,90 ₺
045130016	16/12	20,20 ₺
045130018	18/13	39,00 ₺
045130020-1	20/16	48,05 ₺
045130022	22/16	50,65 ₺
045130028	28/20	121,00 ₺

₺ = så længe lager haves

T-stk kompres/nip gren

MESSING - BSPT



Varenr.	Ø/ø × BSPT × Ø/ø	DKK
045036222	18/13 × 1/2" × 18/13	34,20 ₺
045036263	22/16 × 1/2" × 22/16	47,20 ₺
045036022	22/16 × 3/4" × 22/16	47,20 ₺
045036028	28/20 × 1" × 28/20	88,10 ₺

₺ = så længe lager haves

T-stk kompres/muf gren

MESSING - BSPP



Varenr.	Ø/ø × BSPP × Ø/ø	DKK
045037015	15/10 × 1/2" × 15/10	26,60 ₺
045137015	15/ × 1/2" × 15/	26,60 ₺
045137176	15/ × 3/4" × 15/	9,65 ₺
045037222	18/13 × 1/2" × 18/13	32,75 ₺
045137232	18/13 × 3/4" × 18/13	9,65 ₺
045037239-1	20/16 × 1/2" × 20/16	51,25 ₺
045037263	22/16 × 1/2" × 22/16	54,10 ₺
045037022	22/16 × 3/4" × 22/16	48,25 ₺
045037028	28/20 × 1" × 28/20	104,50 ₺

₺ = så længe lager haves

Kryds kompres

MESSING



Varenr.	Ø/ø	DKK
045180015	15/10	82,50 ₺
045180018	18/13	89,35 ₺
045180022	22/16	141,50 ₺

₺ = så længe lager haves

Omløber kompres

MESSING



Varenr.	ø	DKK
045095132	12	5,55 ₺
045095222	18	7,50 ₺
045095263	22	8,90 ₺
045095028	28	17,75 ₺

₺ = så længe lager haves

Kompres konusring

MESSING



Varenr.	ø	DKK
045096132	12	2,39 ₺
045096222	18	3,67 ₺
045096263	22	4,28 ₺
045096028	28	11,40 ₺

₺ = så længe lager haves

Fordeler

MESSING - BSPP



Varenr.	In × Out	DKK
047084006	3/4" × 4-1/2"	351,50 ₺

₺ = så længe lager haves

Bukkefix
STÅL



Varenr.	Ø	DKK
087251015	12 - 15	13,55
087251018	16 - 18	18,15

KOMPRESION FITTINGS MESSING VA GODKENDT TIL VARME



Max. 30bar
(fittings m. pakning: 10bar)



-20°C til 200°C
(fittings m. pakning: 110°C)



Kompressionskoblinger anvendes til samling af PEX-rør i centralvarmeanlæg. Driftstryk i installationen må ikke overstige 1000 kPa.

Samlinger skal udføres i overensstemmelse med producentens vejledninger. I bygninger skal samlinger være fritliggende eller monteret i udsparinger eller

foringsrør, så utætheder er synlige og dele umiddelbart kan udskiftes.

Nippel kompres MESSING - BSPT



Varenr.	Ø/ø × BSPT	DKK
045160239	20/16 × 1/2"	20,00 ₺

₺ = så længe lager haves

Vinkel 90° kompres/nip MESSING - BSPT



Varenr.	Ø/ø × BSPT	DKK
045121239	20/16 × 1/2"	34,20 ₺

₺ = så længe lager haves

Muffe kompres MESSING - BSPP



Varenr.	Ø/ø × BSPP	DKK
045165239	20/16 × 1/2"	23,70 ₺

₺ = så længe lager haves

Vinkel 90° kompres/muf MESSING - BSPP



Varenr.	Ø/ø × BSPP	DKK
045123246	20/16 × 3/4"	31,95 ₺

₺ = så længe lager haves

Union kompres MESSING



Varenr.	Ø/ø	DKK
045170020	20/16	38,40 ₺

₺ = så længe lager haves

T-stk kompres MESSING



Varenr.	Ø/ø	DKK
045130020	20/16	52,95 ₺

₺ = så længe lager haves

Omløber kompres MESSING



Varenr.	Ø	DKK
045095020	20	8,95 ₺

₺ = så længe lager haves

Kompres konusring MESSING



Varenr.	Ø	DKK
045096020	20	4,06 ₺

₺ = så længe lager haves

Fordeler MESSING - BSPP



Varenr.	In × Out	DKK
047084006	3/4" × 4-1/2"	351,50 ₺

₺ = så længe lager haves

Bukkefix STÅL



Varenr.	Ø	DKK
087251022	20 - 22	32,20
087251025	24 - 26	63,55

INDUSTRIEL KOMPRESSIONS FITTINGS



Messing kompressionsfittings, bredt program til brug i industrien. Særlig stærk til brug under extreme installationer både med hensyn til tryk og temperatur.

Max tryk: Ø4 = 148bar, Ø6 = 148bar, Ø8 = 128 bar, Ø10 = 178bar, Ø12 = 128bar, Ø14 = 113 bar, Ø16 = 74 bar, Ø18 = 59bar, Ø22 = 39bar

Nippel kompres MESSING - BSPT



Varenr.	ø × BSPT	DKK
E10480418	4 × 1/8"	11,20
E10480414	4 × 1/4"	10,20
E10480618	6 × 1/8"	11,65
E10480614	6 × 1/4"	13,30
E10480638	6 × 3/8"	16,45
E10480814	8 × 1/4"	14,85
E10480838	8 × 3/8"	17,40
E104801014	10 × 1/4"	19,65
E104801038	10 × 3/8"	19,10
E104801012	10 × 1/2"	20,95
E104801214	12 × 1/4"	19,65
E104801238	12 × 3/8"	19,65
E104801212	12 × 1/2"	23,20
E104801438	14 × 3/8"	22,90
E104801412	14 × 1/2"	23,20
E104801538	15 × 3/8"	48,00
E104801512	15 × 1/2"	23,50
E104801612	16 × 1/2"	26,10
E104801812	18 × 1/2"	31,50
E104801834	18 × 3/4"	37,85
E104802212	22 × 1/2"	55,45
E104802234	22 × 3/4"	56,25
E10480221	22 × 1"	108,00
E104802834	28 × 3/4"	110,00
E10480281	28 × 1"	104,25
E1048028114	28 × 1 1/4"	160,00
E10480351	35 × 1"	158,75
E10480542	54 × 2"	252,25

Nippel kompres MESSING - BSPP



Varenr.	ø × BSPP	DKK
E10485418	4 × 1/8"	16,70
E10485618	6 × 1/8"	17,40
E10485614	6 × 1/4"	19,65
E10485818	8 × 1/8"	19,65
E10485814	8 × 1/4"	20,30
E10485838	8 × 3/8"	31,50
E104851014	10 × 1/4"	31,20
E104851038	10 × 3/8"	37,85
E104851438	14 × 3/8"	40,85
E104851412	14 × 1/2"	51,65
E104852234	22 × 3/4"	102,00
E10485221	22 × 1"	158,75

Muffe kompres MESSING - BSPP



Varenr.	ø × BSPP	DKK
E10500418	4 × 1/8"	13,95
E10500414	4 × 1/4"	15,45
E10500618	6 × 1/8"	14,85
E10500614	6 × 1/4"	15,75
E10500818	8 × 1/8"	16,20
E10500814	8 × 1/4"	17,10
E10500838	8 × 3/8"	19,35
E105001014	10 × 1/4"	19,65
E105001038	10 × 3/8"	21,30
E105001012	10 × 1/2"	23,80
E105001214	12 × 1/4"	20,95
E105001238	12 × 3/8"	22,60
E105001212	12 × 1/2"	25,45
E105001438	14 × 3/8"	23,50
E105001512	15 × 1/2"	26,10
E105001612	16 × 1/2"	29,50
E105001634	16 × 3/4"	37,85
E105001812	18 × 1/2"	30,90
E105001834	18 × 3/4"	40,00
E105002234	22 × 3/4"	57,90
E10500281	28 × 1"	46,95
E1050042112	42 × 1 1/2"	142,75
E10500542	54 × 2"	257,25

Union kompres

MESSING



Varenr.	∅	DKK
E104604	4	18,40
E104606	6	20,70
E104608	8	23,80
E1046010	10	27,05
E1046012	12	31,50
E1046014	14	35,85
E1046015	15	36,70
E1046016	16	42,20
E1046018	18	49,95
E1046022	22	84,65
E1046028	28	92,25

Nippel m. rørstyrkke

MESSING - BSPP



Varenr.	∅ × BSPP	DKK
E10530618	6 × 1/8"	14,25
E105301014	10 × 1/4"	18,40
E105301038	10 × 3/8"	31,50

Vinkel 90° kompres/nippel

MESSING - BSPT



Varenr.	∅ × BSPT	DKK
E10280418	4 × 1/8"	13,95
E10280618	6 × 1/8"	16,20
E10280614	6 × 1/4"	15,75
E10280818	8 × 1/8"	18,75
E10280814	8 × 1/4"	19,10
E10280838	8 × 3/8"	21,60
E102801014	10 × 1/4"	22,60
E102801038	10 × 3/8"	22,60
E102801012	10 × 1/2"	26,75
E102801214	12 × 1/4"	24,80
E102801238	12 × 3/8"	26,10
E102801212	12 × 1/2"	28,40
E102801412	14 × 1/2"	33,65
E102801512	15 × 1/2"	35,05
E102801612	16 × 1/2"	38,60
E102801812	18 × 1/2"	46,95
E102801834	18 × 3/4"	48,00
E102802234	22 × 3/4"	71,55
E102802834	28 × 3/4"	99,95

KOMPRESION FITTINGS

Skotgennemføring kompres

MESSING



Varenr.	∅	Ext. dim	DKK
E104654	4	8	18,40
E104656	6	10	20,70
E104658	8	12	40,85
E1046510	10	16	27,05
E1046512	12	18	31,50
E1046514	14	20	35,85

Prop kompres

MESSING



Varenr.	∅	DKK
E107806	6	5,85
E107808	8	7,15
E1078010	10	8,30
E1078012	12	10,20
E1078014	14	12,55
E1078015	15	14,85
E1078016	16	16,20
E1078018	18	19,35
E1078022	22	22,60

Vinkel 90° kompres

MESSING

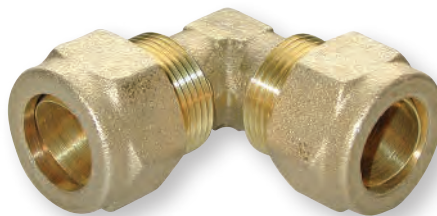

Varenr.	∅	DKK
E102604	4	19,65
E102606	6	22,60
E102608	8	26,10
E1026010	10	30,90
E1026012	12	37,85
E1026014	14	42,20
E1026015	15	45,25
E1026016	16	51,65
E1026018	18	60,05
E1026022	22	95,30
E1026042	42	292,25

Vinkel 90° kompres/muffe

MESSING - BSPP



Varenr.	∅ × BSPP	DKK
E10290418	4 × 1/8"	16,20
E10290618	6 × 1/8"	17,10
E10290614	6 × 1/4"	17,75
E10290818	8 × 1/8"	19,35
E10290814	8 × 1/4"	26,75
E10290838	8 × 3/8"	26,10
E102901014	10 × 1/4"	22,90
E102901038	10 × 3/8"	27,35
E102901012	10 × 1/2"	29,25
E102901214	12 × 1/4"	26,40
E102901238	12 × 3/8"	28,70
E102901212	12 × 1/2"	31,20
E102901512	15 × 1/2"	37,25
E102901612	16 × 1/2"	39,75
E102901812	18 × 1/2"	46,95
E102901834	18 × 3/4"	52,15

Slangenippel kompres

MESSING



Varenr.	A × B	DKK
E105400810	10 × 8	18,75
E105401010	10 × 10	19,65
E105401213	13 × 12	24,80

Banjo kompres/nippel

MESSING - BSPP



Varenr.	ø × BSPP	DKK
E10550418	4 × 1/8"	47,45
E10550618	6 × 1/8"	38,90
E10550818	8 × 1/8"	57,90
E10550814	8 × 1/4"	57,90
E105501014	10 × 1/4"	89,25
E105501038	10 × 3/8"	94,50

T-stk kompres

MESSING



Varenr.	ø	DKK
E102004	4	26,75
E102006	6	30,35
E102008	8	35,05
E1020010	10	44,15
E1020012	12	49,95
E1020014	14	64,45
E1020016	16	71,55
E1020018	18	89,00
E1020022	22	130,25
E1020042	42	347,25

T-stk kompres/nippel gren

MESSING - BSPT



Varenr.	ø × BSPT × ø	DKK
E10220418	4 × 1/8" × 4	21,30
E10220618	6 × 1/8" × 6	24,50
E10220614	6 × 1/4" × 6	24,80
E10220818	8 × 1/8" × 8	28,15
E10220814	8 × 1/4" × 8	28,40
E10220838	8 × 3/8" × 8	33,40
E102201014	10 × 1/4" × 10	35,60
E102201038	10 × 3/8" × 10	40,55
E102201012	10 × 1/2" × 10	38,90
E102201214	12 × 1/4" × 12	39,15
E102201238	12 × 3/8" × 12	40,00
E102201212	12 × 1/2" × 12	41,95
E102201412	14 × 1/2" × 14	54,05
E102201812	18 × 1/2" × 18	73,15
E102201834	18 × 3/4" × 18	75,10
E102202234	22 × 3/4" × 22	110,25

T-stk kompres/muffe gren

MESSING - BSPP



Varenr.	ø × BSPP × ø	DKK
E10240618	6 × 1/8" × 6	24,50
E10240614	6 × 1/4" × 6	30,90
E10240818	8 × 1/8" × 8	27,65
E10240814	8 × 1/4" × 8	33,40
E10240838	8 × 3/8" × 8	36,45
E102401014	10 × 1/4" × 10	35,60
E102401038	10 × 3/8" × 10	38,35
E102401012	10 × 1/2" × 10	43,05
E102401214	12 × 1/4" × 12	41,45
E102401238	12 × 3/8" × 12	41,45
E102401212	12 × 1/2" × 12	39,75
E102401512	15 × 1/2" × 15	54,60
E102401612	16 × 1/2" × 16	60,65
E102401812	18 × 1/2" × 18	73,15

T-stk kompres/nippel ende

MESSING - BSPT



Varenr.	BSPT × ø × ø	DKK
E10230618	1/8" × 6 × 6	24,80
E10230614	1/4" × 6 × 6	24,80
E10230818	1/8" × 8 × 8	28,15
E10230814	1/4" × 8 × 8	28,40
E10230838	3/8" × 8 × 8	32,85
E102301014	1/4" × 10 × 10	35,60
E102301038	3/8" × 10 × 10	35,85
E102301238	3/8" × 12 × 12	40,00
E102301212	1/2" × 12 × 12	45,50

Kryds kompres

MESSING



Varenr.	ø	DKK
E105106	6	62,00
E105108	8	74,80
E1051010	10	94,20
E1051014	14	118,75

Rør i rulle

KOBBER



Varenr.	Ø	- -	L	DKK/m
CU1-1	4	1	65m	31,60
CU1-4	6	1	50m	45,70
CU1-6	8	1	50m	52,05
CU1-8	10	1	50m	70,45
CU1-9	12	1	50m	78,65
	Ø			
CU2-0	1/8"		50m	97,80
CU2-1	3/16"		50m	45,35
CU2-2	1/4"		50m	52,30
CU2-4	3/8"		50m	59,00
CU2-6	1/2"		50m	79,75

Sælges kun i fuld længde

Skotgennemføring kompres

MESSING



Varenr.	ø	Ext. dim	DKK
E114515	15	21	46,05
E114522	22	29	61,70
E114528	28	35	91,75
E114535	35	42	166,25
E114542	42	49	250,50
E114554	54	64	332,25

T-stk kompres m. aftap

MESSING



Varenr.	ø	DKK
E114215	15	109,50
E114222	22	120,75
E114228	28	144,25

Vinkel 90° kompres/muffe

MESSING - BSPP



Med vægbeslag		
Varenr.	ø × BSPP	DKK
E11061012	10 × 1/2"	35,60
E11061212	12 × 1/2"	35,60
E11061412	14 × 1/2"	35,60
E11061512	15 × 1/2"	37,85
E11061534	15 × 3/4"	81,40
E11061612	16 × 1/2"	35,60
E11061812	18 × 1/2"	66,10
E11061834	18 × 3/4"	78,90
E11062212	22 × 1/2"	71,00
E11062234	22 × 3/4"	87,95

Slutmuffe kompres

MESSING



Varenr.	ø	DKK
E113508	8	15,75
E113510	10	14,85
E113512	12	12,30
E113515	15	16,70
E113518	18	32,30
E113522	22	29,25
E113528	28	42,50
E113535	35	141,75
E113542	42	194,25
E113554	54	236,75

Omløber kompres

MESSING



Varenr.	Ø	Int. dim	DKK
E106804	4	M8*1	3,52
E106806	6	M10*1	3,86
E106808	8	M12*1	4,74
E1068010	10	M16*1,5	6,45
E1068012	12	M18*1,5	6,85
E1068014	14	M20*1,5	7,15
E1068015	15	M20*1,5	7,15
E1068016	16	M22*1,5	8,15
E1068018	18	M24*1,5	10,45
E1068022	22	M30*1,5	19,35

Konusring kompres

MESSING



Varenr.	ø	DKK
E107404	4	1,32
E107406	6	1,60
E107408	8	1,82
E1074010	10	2,32
E1074012	12	2,87
E1074014	14	3,75
E1074015	15	3,64
E1074016	16	4,52
E1074018	18	4,90
E1074020	20	8,50
E1074022	22	6,20
E1074028	28	9,60

Konusring kompres

PTFE (TEFLON)



Varenr.	ø	DKK
E107604	4	1,32
E107606	6	1,60
E107608	8	1,82
E1076010	10	2,32
E1076012	12	3,09
E1076015	15	3,64
E1076018	18	4,90
E1076022	22	6,20

Støttebøsning

MESSING



Varenr.	Ø1	Ø2	DKK
E10770427	2,7	4	3,25
E1077064	4	6	3,42
E1077086	6	8	3,52
E10770108	8	10	3,86
E10770129	9	12	4,19
E107701210	10	12	4,31
E107701412	12	14	8,15
E1077015125	12,5	15	7,15
E107701613	13	16	7,25
E107701614	14	16	8,40
E107701815	15	18	10,75
E107701816	16	18	10,75
E107702218	18	22	10,75
E107702820	20	28	15,75
E107702822	22	28	14,70

Ø1 = hylse udvendigt, Ø2 = krave udvendigt

MANOMETRE & FLOWMETRE



172 MANOMETRE RUTFRI
MED GLYCERIN



178 MANOMETRE
PLAST



182 VAKUUMMETRE



185 TERMOMETRE



187 MANOMETER
TILBEHØR



189 FLOWMETRE

MANOMETRE RUSTFRI MED GLYCERIN



-5°C til +75°C



Præcisionsklasse 2,5
(Ø100 = 1,6)



Rustfri manometre med bagud- og nedadrettet tilslutning, i mange forskellige størrelser.

Til luft og vand - ikke til damp.

NB! Husk ALTID at klippe toppen af gummidutten ovenpå huset inden ibrugtagning. Og sørg for at gummidutten peger opad efter montering.

FOR DIN EGEN SIKKERHEDS SKYLD!



Husk altid at klippe toppen af gummiproppen på manometre med glycerin.

Tryk og skala:

Statisk tryk max 3/4 af skalaen.

Pulserende tryk max 2/3 af skalaen.



Manometer Ø100

AISI 304 / STUDS = MESSING



Manometer Ø50

AISI 304 / STUDS = MESSING



BSPB studs nedad

Varenr.	BSPB	BAR	DKK
GC13-2	1/4"	0 - 1	208,25
GC13-3	1/4"	0 - 1,6	177,00
GC13-4	1/4"	0 - 2,5	174,25
GC13-5	1/4"	0 - 4	174,25
GC13-6	1/4"	0 - 6	174,25
GC13-7	1/4"	0 - 10	174,25
GC13-9	1/4"	0 - 16	174,25
GC13-11	1/4"	0 - 25	174,25
GC13-12	1/4"	0 - 40	179,75
GC13-13	1/4"	0 - 60	201,50
GC13-14	1/4"	0 - 100	201,50
GC13-15	1/4"	0 - 160	201,50
GC13-16	1/4"	0 - 250	201,50
GC13-17	1/4"	0 - 400	201,50

BSPB studs nedad

Varenr.	BSPB	BAR	DKK
GC15-2	1/2"	0 - 1	682,50
GC15-3	1/2"	0 - 1,6	682,50
GC15-4	1/2"	0 - 2,5	562,00
GC15-5	1/2"	0 - 4	562,00
GC15-6	1/2"	0 - 6	562,00
GC15-7	1/2"	0 - 10	562,00
GC15-9	1/2"	0 - 16	562,00
GC15-11	1/2"	0 - 25	562,00
GC15-12	1/2"	0 - 40	562,00
GC15-13	1/2"	0 - 60	590,25
GC15-14	1/2"	0 - 100	590,25
GC15-15	1/2"	0 - 160	590,25
GC15-16	1/2"	0 - 250	590,25
GC15-17	1/2"	0 - 400	590,25
GC15-18	1/2"	0 - 600	590,25
GC15-19	1/2"	0 - 1000	1142,50

Manometer Ø63

AISI 304 / STUDS = MESSING



BSPB studs nedad

Varenr.	BSPB	BAR	DKK
GC14-2	1/4"	0 - 1	208,25
GC14-3	1/4"	0 - 1,6	177,00
GC14-4	1/4"	0 - 2,5	174,25
GC14-5	1/4"	0 - 4	174,25
GC14-6	1/4"	0 - 6	174,25
GC14-7	1/4"	0 - 10	174,25
GC14-8	1/4"	0 - 12	174,25
GC14-9	1/4"	0 - 16	174,25
GC14-11	1/4"	0 - 25	174,25
GC14-12	1/4"	0 - 40	179,75
GC14-13	1/4"	0 - 60	201,50
GC14-14	1/4"	0 - 100	201,50
GC14-15	1/4"	0 - 160	201,50
GC14-16	1/4"	0 - 250	201,50
GC14-17	1/4"	0 - 400	201,50
GC14-18	1/4"	0 - 600	201,50



Manometer Ø63

AISI 304 / STUDS = MESSING



BSPP studs bagud

Varenr.	BSPP	BAR	DKK
GC18-2	1/4"	0 - 1	208,25
GC18-3	1/4"	0 - 1,6	177,00
GC18-4	1/4"	0 - 2,5	174,25
GC18-5	1/4"	0 - 4	174,25
GC18-6	1/4"	0 - 6	174,25
GC18-7	1/4"	0 - 10	174,25
GC18-8	1/4"	0 - 12	174,25
GC18-9	1/4"	0 - 16	174,25
GC18-11	1/4"	0 - 25	174,25
GC18-12	1/4"	0 - 40	179,75
GC18-13	1/4"	0 - 60	201,50
GC18-14	1/4"	0 - 100	201,50
GC18-15	1/4"	0 - 160	201,50
GC18-16	1/4"	0 - 250	201,50
GC18-17	1/4"	0 - 400	201,50
GC18-18	1/4"	0 - 600	201,50

Manometer Ø100

AISI 304 / STUDS = MESSING



BSPP studs bagud

Varenr.	BSPP	BAR	DKK
GC19-2	1/2"	0 - 1	682,50
GC19-3	1/2"	0 - 1,6	682,50
GC19-4	1/2"	0 - 2,5	562,00
GC19-5	1/2"	0 - 4	562,00
GC19-6	1/2"	0 - 6	562,00
GC19-7	1/2"	0 - 10	562,00
GC19-9	1/2"	0 - 16	562,00
GC19-11	1/2"	0 - 25	562,00
GC19-12	1/2"	0 - 40	562,00
GC19-13	1/2"	0 - 60	590,25
GC19-14	1/2"	0 - 100	590,25
GC19-15	1/2"	0 - 160	590,25
GC19-16	1/2"	0 - 250	590,25
GC19-17	1/2"	0 - 400	590,25
GC19-18	1/2"	0 - 600	590,25
GC19-19	1/2"	0 - 1000	1142,50

Manometer Ø50

AISI 304 / STUDES = AISI 316



BSPT studs nedad

Varenr.	BSPT	BAR	DKK
GC21-4	1/4"	0 - 2,5	461,75 ☒
GC21-5	1/4"	0 - 4	461,75 ☒
GC21-6	1/4"	0 - 6	461,75
GC21-7	1/4"	0 - 10	461,75
GC21-8	1/4"	0 - 12	461,75 ☒
GC21-9	1/4"	0 - 16	461,75 ☒
GC21-11	1/4"	0 - 25	461,75 ☒
GC21-12	1/4"	0 - 40	461,75 ☒

☒ = skaffevare

Manometer Ø63

AISI 304 / STUDES = AISI 316



BSPT studs nedad

Varenr.	BSPT	BAR	DKK
GC22-2	1/4"	0 - 1	573,25 ☒
GC22-3	1/4"	0 - 1,6	573,25 ☒
GC22-4	1/4"	0 - 2,5	573,25 ☒
GC22-5	1/4"	0 - 4	573,25 ☒
GC22-6	1/4"	0 - 6	573,25
GC22-7	1/4"	0 - 10	573,25
GC22-8	1/4"	0 - 12	573,25 ☒
GC22-9	1/4"	0 - 16	573,25 ☒
GC22-11	1/4"	0 - 25	573,25 ☒
GC22-12	1/4"	0 - 40	573,25 ☒
GC22-13	1/4"	0 - 60	573,25 ☒
GC22-14	1/4"	0 - 100	573,25 ☒
GC22-15	1/4"	0 - 160	573,25 ☒
GC22-16	1/4"	0 - 250	573,25 ☒
GC22-17	1/4"	0 - 400	573,25 ☒
GC22-18	1/4"	0 - 600	573,25 ☒
GC22-19	1/4"	0 - 1000	573,25 ☒

☒ = skaffevare

Manometer Ø100

AISI 304 / STUDES = AISI 316



BSPT studs nedad

Varenr.	BSPT	BAR	DKK
GC23-2	1/2"	0 - 1	1220,75 ☒
GC23-3	1/2"	0 - 1,6	1220,75 ☒
GC23-4	1/2"	0 - 2,5	1220,75 ☒
GC23-5	1/2"	0 - 4	1220,75 ☒
GC23-6	1/2"	0 - 6	1220,75
GC23-7	1/2"	0 - 10	1220,75
GC23-9	1/2"	0 - 16	1220,75 ☒
GC23-11	1/2"	0 - 25	1220,75 ☒
GC23-12	1/2"	0 - 40	1220,75 ☒
GC23-13	1/2"	0 - 60	1220,75 ☒
GC23-14	1/2"	0 - 100	1220,75 ☒
GC23-15	1/2"	0 - 160	1220,75 ☒
GC23-16	1/2"	0 - 250	1220,75 ☒
GC23-17	1/2"	0 - 400	1220,75 ☒
GC23-18	1/2"	0 - 600	1220,75 ☒
GC23-19	1/2"	0 - 1000	1220,75 ☒
GC23-20	1/2"	0 - 1600	1220,75 ☒

☒ = skaffevare

Manometer Ø150

AISI 304 / STUDES = AISI 316



BSPT studs nedad

Varenr.	BSPT	BAR	DKK
GC24-2	1/2"	0 - 1	1641,00 ☒
GC24-3	1/2"	0 - 1,6	1641,00 ☒
GC24-4	1/2"	0 - 2,5	1641,00 ☒
GC24-5	1/2"	0 - 4	1641,00 ☒
GC24-6	1/2"	0 - 6	1641,00 ☒
GC24-7	1/2"	0 - 10	1641,00 ☒
GC24-9	1/2"	0 - 16	1641,00 ☒
GC24-11	1/2"	0 - 25	1641,00 ☒
GC24-12	1/2"	0 - 40	1641,00 ☒
GC24-13	1/2"	0 - 60	1641,00 ☒
GC24-14	1/2"	0 - 100	1641,00 ☒
GC24-15	1/2"	0 - 160	1641,00 ☒
GC24-16	1/2"	0 - 250	1641,00 ☒
GC24-17	1/2"	0 - 400	1641,00 ☒
GC24-18	1/2"	0 - 600	1641,00 ☒
GC24-19	1/2"	0 - 1000	1641,00 ☒
GC24-20	1/2"	0 - 1600	1641,00 ☒

☒ = skaffevare

Manometer Ø50

AISI 304 / STUDS = AISI 316



BSPP studs bagud

Varenr.	BSPP	BAR	DKK
GC25-4	1/4"	0 - 2,5	530,75 ₺
GC25-5	1/4"	0 - 4	530,75 ₺
GC25-6	1/4"	0 - 6	530,75 ₺
GC25-7	1/4"	0 - 10	530,75 ₺
GC25-8	1/4"	0 - 12	530,75 ₺
GC25-9	1/4"	0 - 16	530,75 ₺
GC25-11	1/4"	0 - 25	530,75 ₺
GC25-12	1/4"	0 - 40	530,75 ₺

₺ = skaffevare

Manometer Ø63

AISI 304 / STUDS = AISI 316



BSPP studs bagud

Varenr.	BSPP	BAR	DKK
GC26-2	1/4"	0 - 1	573,25 ₺
GC26-3	1/4"	0 - 1,6	573,25 ₺
GC26-4	1/4"	0 - 2,5	573,25 ₺
GC26-5	1/4"	0 - 4	573,25 ₺
GC26-6	1/4"	0 - 6	573,25 ₺
GC26-7	1/4"	0 - 10	573,25 ₺
GC26-8	1/4"	0 - 12	573,25 ₺
GC26-9	1/4"	0 - 16	573,25 ₺
GC26-11	1/4"	0 - 25	573,25 ₺
GC26-12	1/4"	0 - 40	573,25 ₺
GC26-13	1/4"	0 - 60	573,25 ₺
GC26-14	1/4"	0 - 100	573,25 ₺
GC26-15	1/4"	0 - 160	573,25 ₺
GC26-16	1/4"	0 - 250	573,25 ₺
GC26-17	1/4"	0 - 400	573,25 ₺
GC26-18	1/4"	0 - 600	573,25 ₺
GC26-19	1/4"	0 - 1000	573,25 ₺

₺ = skaffevare

Manometer Ø100

AISI 304 / STUDS = AISI 316



BSPP studs bagud

Varenr.	BSPP	BAR	DKK
GC27-2	1/2"	0 - 1	1220,75 ₺
GC27-3	1/2"	0 - 1,6	1220,75 ₺
GC27-4	1/2"	0 - 2,5	1220,75 ₺
GC27-5	1/2"	0 - 4	1220,75 ₺
GC27-6	1/2"	0 - 6	1220,75 ₺
GC27-7	1/2"	0 - 10	1220,75 ₺
GC27-9	1/2"	0 - 16	1220,75 ₺
GC27-11	1/2"	0 - 25	1220,75 ₺
GC27-12	1/2"	0 - 40	1220,75 ₺
GC27-13	1/2"	0 - 60	1220,75 ₺
GC27-14	1/2"	0 - 100	1220,75 ₺
GC27-15	1/2"	0 - 160	1220,75 ₺
GC27-16	1/2"	0 - 250	1220,75 ₺
GC27-17	1/2"	0 - 400	1220,75 ₺
GC27-18	1/2"	0 - 600	1220,75 ₺
GC27-19	1/2"	0 - 1000	1220,75 ₺
GC27-20	1/2"	0 - 1600	1220,75 ₺

₺ = skaffevare

Manometer Ø150

AISI 304 / STUDS = AISI 316



BSPP studs bagud

Varenr.	BSPP	BAR	DKK
GC28-2	1/2"	0 - 1	1641,00 ₺
GC28-3	1/2"	0 - 1,6	1641,00 ₺
GC28-4	1/2"	0 - 2,5	1641,00 ₺
GC28-5	1/2"	0 - 4	1641,00 ₺
GC28-6	1/2"	0 - 6	1641,00 ₺
GC28-7	1/2"	0 - 10	1641,00 ₺
GC28-9	1/2"	0 - 16	1593,00 ₺
GC28-11	1/2"	0 - 25	1641,00 ₺
GC28-12	1/2"	0 - 40	1641,00 ₺
GC28-13	1/2"	0 - 60	1641,00 ₺
GC28-14	1/2"	0 - 100	1641,00 ₺
GC28-15	1/2"	0 - 160	1641,00 ₺
GC28-16	1/2"	0 - 250	1641,00 ₺
GC28-17	1/2"	0 - 400	1641,00 ₺
GC28-18	1/2"	0 - 600	1641,00 ₺
GC28-19	1/2"	0 - 1000	1641,00 ₺
GC28-20	1/2"	0 - 1600	1641,00 ₺

₺ = skaffevare

Manometer Ø100 m. flange

AISI 304 / STUDS = MESSING



Manometer Ø50 m. flange

AISI 304 / STUDS = MESSING



BSPB studs bagud

Varenr.	BSPB	BAR	DKK
GC29-2	1/4"	0 - 1	256,75
GC29-3	1/4"	0 - 1,6	189,50
GC29-4	1/4"	0 - 2,5	182,00
GC29-5	1/4"	0 - 4	182,00
GC29-6	1/4"	0 - 6	182,00
GC29-7	1/4"	0 - 10	182,00
GC29-9	1/4"	0 - 16	182,00
GC29-11	1/4"	0 - 25	182,00
GC29-12	1/4"	0 - 40	187,50
GC29-13	1/4"	0 - 60	211,75
GC29-14	1/4"	0 - 100	211,75
GC29-15	1/4"	0 - 160	211,75
GC29-16	1/4"	0 - 250	211,75
GC29-17	1/4"	0 - 400	211,75

BSPB studs bagud

Varenr.	BSPB	BAR	DKK
GC31-2	1/2"	0 - 1	745,50
GC31-3	1/2"	0 - 1,6	706,75
GC31-4	1/2"	0 - 2,5	580,50
GC31-5	1/2"	0 - 4	580,50
GC31-6	1/2"	0 - 6	580,50
GC31-7	1/2"	0 - 10	580,50
GC31-9	1/2"	0 - 16	580,50
GC31-11	1/2"	0 - 25	580,50
GC31-12	1/2"	0 - 40	580,50
GC31-13	1/2"	0 - 60	608,75
GC31-14	1/2"	0 - 100	608,75
GC31-15	1/2"	0 - 160	608,75
GC31-16	1/2"	0 - 250	608,75
GC31-17	1/2"	0 - 400	608,75
GC31-18	1/2"	0 - 600	608,75
GC31-19	1/2"	0 - 1000	1286,50

Manometer Ø63 m. flange

AISI 304 / STUDS = MESSING



BSPB studs bagud

Varenr.	BSPB	BAR	DKK
GC30-2	1/4"	0 - 1	256,75
GC30-3	1/4"	0 - 1,6	189,50
GC30-4	1/4"	0 - 2,5	182,00
GC30-5	1/4"	0 - 4	182,00
GC30-6	1/4"	0 - 6	182,00
GC30-7	1/4"	0 - 10	182,00
GC30-8	1/4"	0 - 12	182,00
GC30-9	1/4"	0 - 16	182,00
GC30-11	1/4"	0 - 25	182,00
GC30-12	1/4"	0 - 40	187,50
GC30-13	1/4"	0 - 60	211,75
GC30-14	1/4"	0 - 100	211,75
GC30-15	1/4"	0 - 160	211,75
GC30-16	1/4"	0 - 250	211,75
GC30-17	1/4"	0 - 400	211,75
GC30-18	1/4"	0 - 600	211,75

Manometer Ø150 m. flange

AISI 304 / STUDS = MESSING



BSPB studs bagud

Varenr.	BSPB	BAR	DKK
GC32-6	1/2"	0 - 6	504,75 ♂

♂ = så længe lager haves

MANOMETRE PLAST



Se hver type manometer



Præcisionsklasse 2,5



Plast manometre med bagud- og nedadrettet tilslutning, i mange forskellige størrelser.

Til luft og vand - ikke til damp.

Manometer Ø40

PA (POLYAMID) / STUDS = MESSING



BSPT studs nedad

Varenr.	BSPT	BAR	DKK
GC1-2	1/8"	0 - 1	120,00
GC1-3	1/8"	0 - 1,6	117,25
GC1-4	1/8"	0 - 2,5	82,50
GC1-5	1/8"	0 - 4	82,50
GC1-6	1/8"	0 - 6	82,50
GC1-7	1/8"	0 - 10	82,50
GC1-8	1/8"	0 - 12	82,50
GC1-9	1/8"	0 - 16	82,50
GC1-10	1/8"	0 - 20	82,50

Manometer Ø50

PA (POLYAMID) / STUDS = MESSING



BSPT studs nedad

Varenr.	BSPT	BAR	DKK
GC2-2	1/4"	0 - 1	120,00
GC2-3	1/4"	0 - 1,6	117,25
GC2-4	1/4"	0 - 2,5	82,50
GC2-5	1/4"	0 - 4	82,50
GC2-6	1/4"	0 - 6	82,50
GC2-7	1/4"	0 - 10	82,50
GC2-8	1/4"	0 - 12	82,50
GC2-9	1/4"	0 - 16	82,50
GC2-10	1/4"	0 - 20	82,50
GC2-11	1/4"	0 - 25	82,50

Manometer Ø63

PA (POLYAMID) / STUDS = MESSING



BSPT studs nedad

Varenr.	BSPT	BAR	DKK
GC3-2	1/4"	0 - 1	122,25
GC3-3	1/4"	0 - 1,6	117,25
GC3-4	1/4"	0 - 2,5	84,10
GC3-5	1/4"	0 - 4	84,10
GC3-6	1/4"	0 - 6	84,10
GC3-7	1/4"	0 - 10	84,10
GC3-8	1/4"	0 - 12	84,10
GC3-9	1/4"	0 - 16	84,10
GC3-10	1/4"	0 - 20	84,10
GC3-11	1/4"	0 - 25	84,10
GC3-12	1/4"	0 - 40	93,90
GC3-13	1/4"	0 - 60	106,50



Manometer Ø80

PA (POLYAMID) / STUDS = MESSING



BSPT studs nedad			
Varenr.	BSPT	BAR	DKK
GC4-2	3/8"	0 - 1	202,75
GC4-3	3/8"	0 - 1,6	190,50
GC4-4	3/8"	0 - 2,5	168,75
GC4-5	3/8"	0 - 4	168,75
GC4-6	3/8"	0 - 6	168,75
GC4-7	3/8"	0 - 10	168,75
GC4-9	3/8"	0 - 16	168,75
GC4-11	3/8"	0 - 25	168,75
GC4-12	3/8"	0 - 40	168,75
GC4-13	3/8"	0 - 60	199,50
GC4-14	3/8"	0 - 100	199,50
GC4-15	3/8"	0 - 160	199,50
GC4-16	3/8"	0 - 250	199,50
GC4-17	3/8"	0 - 400	199,50

Manometer Ø100

PA (POLYAMID) / STUDS = MESSING



BSPT studs nedad			
Varenr.	BSPT	BAR	DKK
GC5-2	1/2"	0 - 1	260,00
GC5-3	1/2"	0 - 1,6	243,00
GC5-4	1/2"	0 - 2,5	226,00
GC5-5	1/2"	0 - 4	226,00
GC5-6	1/2"	0 - 6	226,00
GC5-7	1/2"	0 - 10	226,00
GC5-9	1/2"	0 - 16	226,00
GC5-11	1/2"	0 - 25	226,00
GC5-12	1/2"	0 - 40	231,00
GC5-13	1/2"	0 - 60	252,75
GC5-14	1/2"	0 - 100	252,75
GC5-15	1/2"	0 - 160	252,75
GC5-16	1/2"	0 - 250	252,75
GC5-17	1/2"	0 - 400	252,75
GC5-18	1/2"	0 - 600	252,75
GC5-19	1/2"	0 - 1000	1062,00 ♂

♂ = så længe lager haves

Manometer Ø50

ABS / STUDS = MESSING



BSPT studs nedad			
Varenr.	BSPT	BAR	DKK
GC42-1	1/4"	0 - 1,6	UDGÅET
GC42-2	1/4"	0 - 2,5	UDGÅET
GC42-3	1/4"	0 - 4	91,75
GC42-4	1/4"	0 - 6	91,75
GC42-5	1/4"	0 - 10	91,75
GC42-6	1/4"	0 - 16	91,75

Manometer Ø63

ABS / STUDS = MESSING



BSPT studs nedad			
Varenr.	BSPT	BAR	DKK
GC43-1	1/4"	0 - 1,6	115,50
GC43-2	1/4"	0 - 2,5	95,80
GC43-3	1/4"	0 - 4	95,80
GC43-4	1/4"	0 - 6	95,80
GC43-5	1/4"	0 - 10	95,80
GC43-6	1/4"	0 - 16	95,80

Manometer Ø80

ABS / STUDS = MESSING



BSPT studs nedad			
Varenr.	BSPT	BAR	DKK
GC44-1	3/8"	0 - 1,6	213,25
GC44-2	3/8"	0 - 2,5	191,00
GC44-3	3/8"	0 - 4	191,00
GC44-4	3/8"	0 - 6	191,00
GC44-5	3/8"	0 - 10	191,00
GC44-6	3/8"	0 - 16	191,00

Manometer Ø100

ABS / STUDS = MESSING



BSPT studs nedad			
Varenr.	BSPT	BAR	DKK
GC45-1	1/2"	0 - 4	262,75
GC45-2	1/2"	0 - 6	262,75
GC45-3	1/2"	0 - 10	262,75
GC45-4	1/2"	0 - 16	262,75

Manometer Ø40

PA (POLYAMID) / STUDS = MESSING



BSPP studs bagud

Varenr.	BSPP	BAR	DKK
GC7-2	1/8"	0 - 1	120,00
GC7-3	1/8"	0 - 1,6	117,25
GC7-4	1/8"	0 - 2,5	82,50
GC7-5	1/8"	0 - 4	82,50
GC7-6	1/8"	0 - 6	82,50
GC7-6-1/4	1/4"	0 - 6	82,50
GC7-7	1/8"	0 - 10	82,50
GC7-8	1/8"	0 - 12	82,50
GC7-9	1/8"	0 - 16	82,50
GC7-10	1/8"	0 - 20	82,50

Manometer Ø63

PA (POLYAMID) / STUDS = MESSING



BSPP studs bagud

Varenr.	BSPP	BAR	DKK
GC9-2	1/4"	0 - 1	122,25
GC9-3	1/4"	0 - 1,6	117,25
GC9-4	1/4"	0 - 2,5	84,10
GC9-5	1/4"	0 - 4	84,10
GC9-6	1/4"	0 - 6	84,10
GC9-7	1/4"	0 - 10	84,10
GC9-8	1/4"	0 - 12	84,10
GC9-9	1/4"	0 - 16	84,10
GC9-10	1/4"	0 - 20	84,10
GC9-11	1/4"	0 - 25	84,10
GC9-12	1/4"	0 - 40	93,90

Manometer Ø100

PA (POLYAMID) / STUDS = MESSING



BSPP studs bagud

Varenr.	BSPP	BAR	DKK
GC11-2	1/2"	0 - 1	268,00
GC11-3	1/2"	0 - 1,6	250,50
GC11-4	1/2"	0 - 2,5	232,75
GC11-5	1/2"	0 - 4	232,75
GC11-6	1/2"	0 - 6	232,75
GC11-7	1/2"	0 - 10	232,75
GC11-9	1/2"	0 - 16	232,75
GC11-11	1/2"	0 - 25	232,75
GC11-12	1/2"	0 - 40	238,25
GC11-13	1/2"	0 - 60	260,50
GC11-14	1/2"	0 - 100	260,50
GC11-15	1/2"	0 - 160	260,50
GC11-16	1/2"	0 - 250	260,50
GC11-17	1/2"	0 - 400	260,50
GC11-18	1/2"	0 - 600	260,50
GC11-19	1/2"	0 - 1000	1093,00

¤ = så længe lager haves

Manometer Ø50

PA (POLYAMID) / STUDS = MESSING



BSPP studs bagud

Varenr.	BSPP	BAR	DKK
GC8-2	1/4"	0 - 1	120,00
GC8-3	1/4"	0 - 1,6	117,25
GC8-4	1/4"	0 - 2,5	82,50
GC8-5	1/4"	0 - 4	82,50
GC8-6	1/4"	0 - 6	82,50
GC8-7	1/4"	0 - 10	82,50
GC8-8	1/4"	0 - 12	82,50
GC8-9	1/4"	0 - 16	82,50
GC8-10	1/4"	0 - 20	82,50
GC8-11	1/4"	0 - 25	82,50

Manometer Ø80

PA (POLYAMID) / STUDS = MESSING



BSPP studs bagud

Varenr.	BSPP	BAR	DKK
GC10-2	3/8"	0 - 1	202,75
GC10-3	3/8"	0 - 1,6	190,50
GC10-4	3/8"	0 - 2,5	168,75
GC10-5	3/8"	0 - 4	168,75
GC10-6	3/8"	0 - 6	168,75
GC10-7	3/8"	0 - 10	168,75
GC10-9	3/8"	0 - 16	168,75
GC10-11	3/8"	0 - 25	168,75
GC10-12	3/8"	0 - 40	168,75
GC10-13	3/8"	0 - 60	199,50
GC10-14	3/8"	0 - 100	199,50
GC10-15	3/8"	0 - 160	199,50
GC10-16	3/8"	0 - 250	199,50
GC10-17	3/8"	0 - 400	199,50

Manometer Ø50

ABS / STUDS = MESSING



BSPT studs bagud

Varenr.	BSPT	BAR	DKK
GC48-1	1/4"	0 - 1,6	110,50
GC48-2	1/4"	0 - 2,5	87,95
GC48-3	1/4"	0 - 4	87,95
GC48-4	1/4"	0 - 6	87,95
GC48-5	1/4"	0 - 10	87,95
GC48-6	1/4"	0 - 16	87,95

Manometer Ø40 m. flange

ABS / STUDS = MESSING



BSPB studs bagud

Varenr.	BSPB	BAR	DKK
GC50-2	1/8"	0 - 1	133,25
GC50-3	1/8"	0 - 1,6	112,25
GC50-4	1/8"	0 - 2,5	85,45
GC50-5	1/8"	0 - 4	80,55
GC50-6	1/8"	0 - 6	80,55
GC50-7	1/4"	0 - 10	80,55
GC50-8	1/8"	0 - 12	80,55
GC50-9	1/8"	0 - 16	80,55
GC50-10	1/8"	0 - 20	85,45

Manometer Ø63 m. flange

ABS / STUDS = MESSING



BSPB studs bagud

Varenr.	BSPB	BAR	DKK
GC52-2	1/4"	0 - 1	136,25
GC52-3	1/4"	0 - 1,6	108,50
GC52-4	1/4"	0 - 2,5	91,70
GC52-5	1/4"	0 - 4	88,40
GC52-6	1/4"	0 - 6	88,40
GC52-7	1/4"	0 - 10	88,40
GC52-8	1/4"	0 - 12	88,40
GC52-9	1/4"	0 - 16	88,40
GC52-10	1/4"	0 - 20	91,70
GC52-11	1/4"	0 - 25	91,70
GC52-12	1/4"	0 - 40	96,65

Manometer Ø63

ABS / STUDS = MESSING



BSPT studs bagud

Varenr.	BSPT	BAR	DKK
GC49-1	1/4"	0 - 1,6	115,25
GC49-2	1/4"	0 - 2,5	92,25
GC49-3	1/4"	0 - 4	92,25
GC49-4	1/4"	0 - 6	92,25
GC49-5	1/4"	0 - 10	92,25
GC49-6	1/4"	0 - 16	92,25

Manometer Ø50 m. flange

ABS / STUDS = MESSING



BSPB studs bagud

Varenr.	BSPB	BAR	DKK
GC51-2	1/4"	0 - 1	133,25
GC51-3	1/4"	0 - 1,6	104,00
GC51-4	1/4"	0 - 2,5	87,10
GC51-5	1/4"	0 - 4	83,80
GC51-6	1/4"	0 - 6	83,80
GC51-7	1/4"	0 - 10	83,80
GC51-8	1/4"	0 - 12	83,80
GC51-9	1/4"	0 - 16	83,80
GC51-10	1/4"	0 - 20	87,10
GC51-11	1/4"	0 - 25	87,10

Skotgennemføring push-in/ manometer



Varenr.	Ø	MPa	Ext. dim.	DKK
EC135-06	6	0-0,8	M14*1	122,00

Vinkel 90° nip/manometer

BSPB

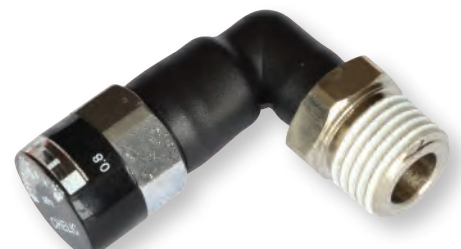

Varenr.	NPT	MPa	DKK
EC133C-06M5	M5	0-0,8	33,10 α
EC133K-0618	1/8"	0-0,8	33,10 α
EC133K-0614	1/4"	0-0,8	33,10 α

α = så længe lager haves



VAKUUMMETRE



Præcisionsklasse 2,5



Plast og rustfri vakuummeter med bagud- og nedadrettet tilslutning, i mange forskellige størrelser.

MANOMETRE & FLOWMETRE

Vakuummeter Ø50

AISI 304 / STUDS = MESSING



BSPP studs nedad

Varenr.	BSPP	BAR	DKK
GC13-1	1/4"	-1 - 0	216,00

Vakuummeter Ø50

AISI 304 / STUDS = MESSING



BSPP studs bagud

Varenr.	BSPP	BAR	DKK
GC17-1	1/4"	-1 - 0	216,00

Vakuummeter Ø100

AISI 304 / STUDS = MESSING



BSPP studs bagud

Varenr.	BSPP	BAR	DKK
GC19-1	1/2"	-1 - 0	682,50

Vakuummeter Ø63

AISI 304 / STUDS = MESSING



BSPP studs nedad

Varenr.	BSPP	BAR	DKK
GC14-1	1/4"	-1 - 0	216,00
GC14-0	1/4"	-1 - +1	225,00
GC14-0-1	1/4"	-1 - +3	225,00

Vakuummeter Ø63

AISI 304 / STUDS = MESSING



BSPP studs bagud

Varenr.	BSPP	BAR	DKK
GC18-1	1/4"	-1 - 0	216,00

Vakuummeter Ø100

AISI 304 / STUDS = MESSING



BSPP studs nedad

Varenr.	BSPP	BAR	DKK
GC15-1	1/2"	-1 - 0	682,50

Vakuummeter Ø63 -1 til +1 bar

AISI 304 / STUDS = MESSING



BSPP studs bagud

Varenr.	BSPP	BAR	DKK
GC18-0	1/4"	-1 - +1	191,00

Vakuummeter Ø63
AISI 304 / STUDS = AISI 316



BSPT studs nedad

Varenr.	BSPT	BAR	DKK
GC22-1	1/4"	-1 - 0	573,25

Vakuummeter Ø63
AISI 304 / STUDS = AISI 316



BSPP studs bagud

Varenr.	BSPP	BAR	DKK
GC26-1	1/4"	-1 - 0	573,25

Vakuummeter Ø100
AISI 304 / STUDS = AISI 316



BSPT studs nedad

Varenr.	BSPT	BAR	DKK
GC23-1	1/2"	-1 - 0	1220,75 α

α = skaffevare

Vakuummeter Ø100
AISI 304 / STUDS = AISI 316



BSPP studs bagud

Varenr.	BSPP	BAR	DKK
GC27-1	1/2"	-1 - 0	1220,75 α

α = skaffevare

Vakuummeter Ø150
AISI 304 / STUDS = AISI 316



BSPT studs nedad

Varenr.	BSPT	BAR	DKK
GC24-1	1/2"	-1 - 0	1641,00 α

α = skaffevare

Vakuummeter Ø150
AISI 304 / STUDS = AISI 316



BSPP studs bagud

Varenr.	BSPP	BAR	DKK
GC28-1	1/2"	-1 - 0	1641,00 α

α = skaffevare

Vakuummeter Ø50 m. flange

AISI 304 / STUDS = MESSING



BSPP studs bagud

Varenr.	BSPP	BAR	DKK
GC29-1	1/4"	-1 - 0	230,00

Vakuummeter Ø63

PA (POLYAMID) / STUDS = MESSING



BSPT studs nedad

Varenr.	BSPT	BAR	DKK
GC3-1	1/4"	-1 - 0	136,75

Vakuummeter Ø40 m. flange

ABS / STUDS = MESSING



BSPP studs bagud

Varenr.	BSPP	BAR	DKK
GC50-1	1/8"	-1 - 0	133,25

Vakuummeter Ø63 m. flange

AISI 304 / STUDS = MESSING



BSPP studs bagud

Varenr.	BSPP	BAR	DKK
GC30-1	1/4"	-1 - 0	230,00

Vakuummeter Ø100

PA (POLYAMID) / STUDS = MESSING



BSPT studs nedad

Varenr.	BSPT	BAR	DKK
GC5-1	1/2"	-1 - 0	266,50

Vakuummeter Ø50 m. flange

ABS / STUDS = MESSING



BSPP studs bagud

Varenr.	BSPP	BAR	DKK
GC51-1	1/4"	-1 - 0	133,25

Vakuummeter Ø100 m. flange

AISI 304 / STUDS = MESSING



BSPP studs bagud

Varenr.	BSPP	BAR	DKK
GC31-1	1/2"	-1 - 0	745,50

Vakuummeter Ø40

PA (POLYAMID) / STUDS = MESSING



BSPP studs bagud

Varenr.	BSPP	BAR	DKK
GC7-1	1/8"	-1 - 0	136,75

Vakuummeter Ø63 m. flange

ABS / STUDS = MESSING



BSPP studs bagud

Varenr.	BSPP	BAR	DKK
GC52-1	1/4"	-1 - 0	136,25

Vakuummeter Ø40

PA (POLYAMID) / STUDS = MESSING



BSPT studs nedad

Varenr.	BSPT	BAR	DKK
GC1-1	1/8"	-1 - 0	120,00

Vakuummeter Ø63

PA (POLYAMID) / STUDS = MESSING



BSPP studs bagud

Varenr.	BSPP	BAR	DKK
GC9-1	1/4"	-1 - 0	136,75

TERMOMETRE



Præcisionsklasse 2



Termometer Ø63

PA (POLYAMID) / DYKRØR = MESSING - BSPT



1/2" ø9xØ11 dykrør bagud

Varenr.	Temp.	L	DKK
G48-0	-30° - 50°C	50mm	88,20
G48-2	0° - 60°C	50mm	88,20
G48-4	0° - 120°C	50mm	88,20
G48-1	-30° - 50°C	100mm	118,50
G48-3	0° - 60°C	100mm	118,50
G48-5	0° - 120°C	100mm	118,50

Dykrør ø9xØ11mm

MESSING - BSPT



Varenr.	BSPT	L	DKK
G49-1	1/2"	50mm	33,25
G49-2	1/2"	100mm	51,60
G49-3	1/2"	150mm	58,15
G49-4	1/2"	200mm	63,65
G49-5	1/2"	250mm	69,35
G49-6	1/2"	300mm	75,90

Termo/manometer Ø63

ABS / STUDS = MESSING



BSPT studs bagud

Varenr.	BSPT	BAR	DKK
GC46-1	1/2"	0 - 4	230,00
GC46-2	1/2"	0 - 6	266,50

Termometer Ø63

PA (POLYAMID) / DYKRØR = MESSING - BSPT



1/2" Ø9 dykrør nedad

Varenr.	Temp.	L	DKK
G51-0	-30° - 50°C	50mm	352,25
G51-2	0° - 60°C	50mm	352,25
G51-4	0° - 120°C	50mm	352,25
G51-1	-30° - 50°C	100mm	375,75
G51-3	0° - 60°C	100mm	375,75
G51-5	0° - 120°C	100mm	375,75

Termo/manometer Ø80

ABS / STUDS = MESSING



BSPT studs nedad

Varenr.	BSPT	BAR	DKK
GC47-1	1/2"	0 - 4	271,75
GC47-2	1/2"	0 - 6	271,75

Termometer 110mm

ALUMINIUM / DYKRØR = MESSING - BSPT



1/2" Ø10 dykrør nedad

Varenr.	Temp.	Dykrør L	DKK
G110-63-1L	-30-50°	63mm	202,00 ₺
G110-63-2L	0-60°	63mm	202,00 ₺
G110-63-3L	0-100°	63mm	202,00 ₺
G110-63-4L	0-120°	63mm	202,00 ₺
G110-63-5L	0-160°	63mm	202,00 ₺
G110-100-1L	-30-50°	100mm	229,25 ₺
G110-100-2L	0-60°	100mm	229,25 ₺
G110-100-3L	0-100°	100mm	229,25 ₺
G110-100-4L	0-120°	100mm	229,25 ₺
G110-100-5L	0-160°	100mm	229,25 ₺
G110-160-1L	-30-50°	160mm	239,25 ₺
G110-160-2L	0-60°	160mm	239,25 ₺
G110-160-3L	0-100°	160mm	239,25 ₺
G110-160-4L	0-120°	160mm	239,25 ₺
G110-160-5L	0-160°	160mm	239,25 ₺

₺ = skaffevare

Termometer 150mm

ALUMINIUM / DYKRØR = MESSING - BSPT



1/2" Ø10 dykrør nedad

Varenr.	Temp.	Dykrør L	DKK
G150-63-1L	-30-50°	63mm	208,75
G150-63-2L	0-60°	63mm	208,75
G150-63-3L	0-100°	63mm	208,75
G150-63-4L	0-120°	63mm	208,75
G150-63-5L	0-160°	63mm	208,75
G150-100-1L	-30-50°	100mm	239,25
G150-100-2L	0-60°	100mm	239,25
G150-100-3L	0-100°	100mm	239,25
G150-100-4L	0-120°	100mm	239,25
G150-100-5L	0-160°	100mm	239,25
G150-160-1L	-30-50°	160mm	247,75
G150-160-2L	0-60°	160mm	247,75
G150-160-3L	0-100°	160mm	247,75
G150-160-4L	0-120°	160mm	247,75
G150-160-5L	0-160°	160mm	247,75

Termometer 200mm

ALUMINIUM / DYKRØR = MESSING - BSPT



1/2" Ø10 dykrør nedad

Varenr.	Temp.	Dykrør L	DKK
G200-63-1L	-30-50°	63mm	217,50 ₺
G200-63-2L	0-60°	63mm	217,50 ₺
G200-63-3L	0-100°	63mm	217,50 ₺
G200-63-4L	0-120°	63mm	217,50 ₺
G200-63-5L	0-160°	63mm	217,50 ₺
G200-100-1L	-30-50°	100mm	252,25 ₺
G200-100-2L	0-60°	100mm	252,25 ₺
G200-100-3L	0-100°	100mm	252,25 ₺
G200-100-4L	0-120°	100mm	252,25 ₺
G200-100-5L	0-160°	100mm	252,25 ₺
G200-160-1L	-30-50°	160mm	261,50 ₺
G200-160-2L	0-60°	160mm	261,50 ₺
G200-160-3L	0-100°	160mm	261,50 ₺
G200-160-4L	0-120°	160mm	261,50 ₺
G200-160-5L	0-160°	160mm	261,50 ₺

₺ = skaffevare

Termometer 110mm

ALUMINIUM / DYKRØR = MESSING - BSPT



1/2" Ø10 dykrør bagud

Varenr.	Temp.	Dykrør L	DKK
G110-63-1V	-30-50°	63mm	205,25 ₺
G110-63-2V	0-60°	63mm	205,25 ₺
G110-63-3V	0-100°	63mm	205,25 ₺
G110-63-4V	0-120°	63mm	205,25 ₺
G110-63-5V	0-160°	63mm	205,25 ₺
G110-100-1V	-30-50°	100mm	234,00 ₺
G110-100-2V	0-60°	100mm	234,00 ₺
G110-100-3V	0-100°	100mm	234,00 ₺
G110-100-4V	0-120°	100mm	234,00 ₺
G110-100-5V	0-160°	100mm	234,00 ₺
G110-160-1V	-30-50°	160mm	243,75 ₺
G110-160-2V	0-60°	160mm	243,75 ₺
G110-160-3V	0-100°	160mm	243,75 ₺
G110-160-4V	0-120°	160mm	243,75 ₺
G110-160-5V	0-160°	160mm	243,75 ₺

₺ = skaffevare

Termometer 150mm

ALUMINIUM / DYKRØR = MESSING - BSPT

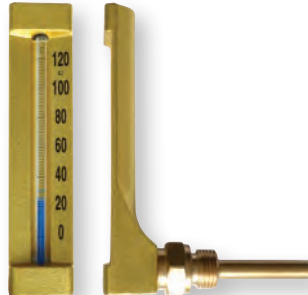

1/2" Ø10 dykrør bagud

Varenr.	Temp.	Dykrør L	DKK
G150-63-1V	-30-50°	63mm	213,50
G150-63-2V	0-60°	63mm	213,50
G150-63-3V	0-100°	63mm	213,50
G150-63-4V	0-120°	63mm	213,50
G150-63-5V	0-160°	63mm	213,50
G150-100-1V	-30-50°	100mm	243,75
G150-100-2V	0-60°	100mm	243,75
G150-100-3V	0-100°	100mm	243,75
G150-100-4V	0-120°	100mm	243,75
G150-100-5V	0-160°	100mm	243,75
G150-160-1V	-30-50°	160mm	252,25
G150-160-2V	0-60°	160mm	252,25
G150-160-3V	0-100°	160mm	252,25
G150-160-4V	0-120°	160mm	252,25
G150-160-5V	0-160°	160mm	252,25

Termometer 200mm

ALUMINIUM / DYKRØR = MESSING - BSPT

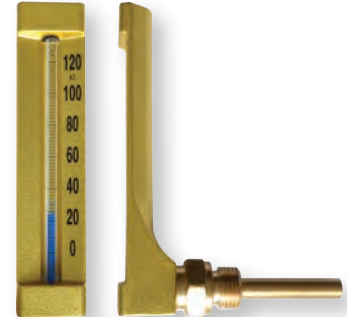

1/2" Ø10 dykrør bagud

Varenr.	Temp.	Dykrør L	DKK
G200-63-1V	-30-50°	63mm	221,75 ₺
G200-63-2V	0-60°	63mm	221,75 ₺
G200-63-3V	0-100°	63mm	221,75 ₺
G200-63-4V	0-120°	63mm	221,75 ₺
G200-63-5V	0-160°	63mm	221,75 ₺
G200-100-1V	-30-50°	100mm	256,50 ₺
G200-100-2V	0-60°	100mm	256,50 ₺
G200-100-3V	0-100°	100mm	256,50 ₺
G200-100-4V	0-120°	100mm	256,50 ₺
G200-100-5V	0-160°	100mm	256,50 ₺
G200-160-1V	-30-50°	160mm	265,75 ₺
G200-160-2V	0-60°	160mm	265,75 ₺
G200-160-3V	0-100°	160mm	265,75 ₺
G200-160-4V	0-120°	160mm	265,75 ₺
G200-160-5V	0-160°	160mm	265,75 ₺

₺ = skaffevare

MANOMETER TILBEHØR



Tilbehør til manometre. For temperatur og tryk se hvert emne.

Manometerkappe PVC (POLYVINYLCHLORID)



Til studs nedad

Varenr.	Str.	DKK
GC90-1	Ø40	11,25
GC91-1	Ø50	11,25
GC92-1	Ø63	11,25

Manometerkappe PVC (POLYVINYLCHLORID)



Til studs bagud

Varenr.	Str.	DKK
GC90-2	Ø40	11,25
GC91-2	Ø50	11,25
GC92-2	Ø63	11,25



Bøjle for manometer STÅL



Kun til rustfri med messingstuds.

Varenr.	Ø	DKK
G50-2	50	25,35
G50-3	63	26,65



Mini kuglehane muf/muf MESSING - BSPP

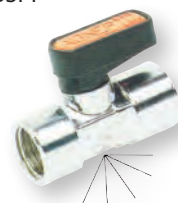

E6600 aflastningsventilen kan bruges til at aflaste manometre. Ved åben ventil er der tryk op til manometret og ved lukket ventil aflastes trykket ud af bagsiden på ventilen.

Med udluftning

Varenr.	BSPP	DKK
E6600-1	1/8"	107,00
E6600-2	1/4"	107,00
E6600-3	3/8"	116,25

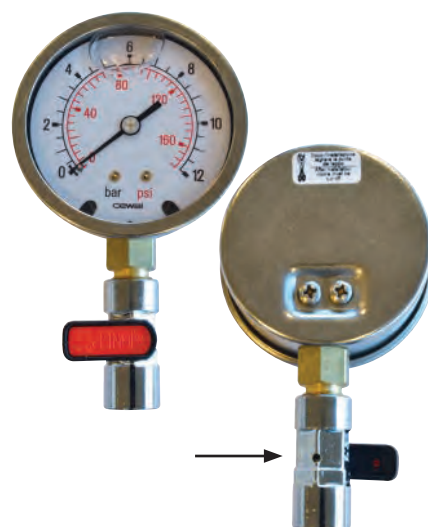

Trykknop ventil



MESSING - BSPP

Isolerer manometer fra medie under drift.

Varenr.	dim	DKK
GC62-2	1/4"	196,50
GC62-3	3/8"	219,50
GC62-4	1/2"	243,00

Absorber AISI 316 - BSPP



Varenr.	dim	DKK
GC64-4	1/2"	839,00

Trykstød reducer



AISI 316 - BSPP

Absorberer trykstød foran et manometer.

Varenr.	dim	BAR	DKK
GC60-2	1/4"	630	692,75
GC60-4	1/2"	630	838,00

Absorber MESSING - BSPP



Varenr.	dim	DKK
GC63-2	1/4"	97,45
GC63-3	3/8"	108,00
GC63-4	1/2"	121,25

Trykstød reducer



MESSING - BSPP

Absorberer trykstød foran et manometer.

Varenr.	dim	BAR	DKK
GC61-2	1/4"	250	149,00
GC61-4	1/2"	250	174,25

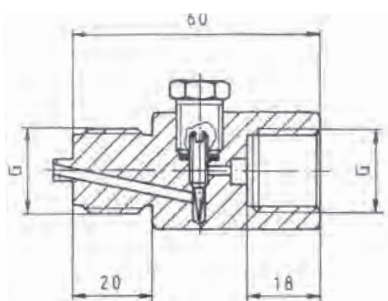

FLOWMETRE



Vand max 9bar,
luft max 7bar



Vand 0°C til +54°C,
luft 0°C til +38°C



Flowmåling af væske og luft

Flowmetre/ flowmålere, også kaldet gennemstrømningsmåler, er et instrument der bruges til at måle volume og hastighedsgennemstrømning (flowmåling) af forskellige medier gennem rør såsom vand, olier, gas og andet.

Anvendelsesområde

Flowmetre anvendes i flere forskellige brancher, herunder industrien og til off-shore. Flowmåling anvendes til stort set alle letflydende og rene væsker, også til aggressive væsker samt til gasser og damp.

Flowregulator til væske

ACRYL - BSPT



Varenr.	BSPT	Flow	DKK
FL2-1	1/4"	16-160 ml/min	463,00
FL2-2	1/4"	80-400 ml/min	463,00
FL2-3	1/4"	100-500 ml/m	463,00
FL2-4	1/4"	100-600 ml/m	463,00
FL2-5	1/4"	200-800 ml/m	463,00
FL2-6	1/4"	100-1000 ml/m	463,00
FL2-7	1/4"	2,5-25 LPH	505,00
FL2-8	1/4"	4-40 LPH	505,00
FL2-9	1/4"	6-60 LPH	505,00
FL2-12	1/2"	10-100 LPH	589,50
FL2-13	1/2"	16-160 LPH	589,50
FL2-14	1/2"	25-250 LPH	589,50
FL2-15	1/2"	0,5-4 LPM	572,25
FL2-16	1/2"	1-7 LPM	589,50
FL2-17	1/2"	1-11 LPM	589,50
FL2-18	1/2"	2-18 LPM	589,50
FL2-19	1"	5-35 LPM	799,75
FL2-20	1"	10-50 LPM	799,75
FL2-21	1"	10-70 LPM	799,75
FL2-22	1"	10-130 LPM	799,75
FL2-23	1"	10-150 LPM	799,75
FL2-24	1"	10-170 LPM	799,75

LPH = liter per time, LPM = liter per minut

Flowregulator til luft

ACRYL - BSPT



Varenr.	BSPT	Flow	DKK
FL3-1	1/4"	1-5 LPM	463,00
FL3-2	1/4"	2-10 LPM	463,00
FL3-3	1/4"	3-15 LPM	463,00
FL3-4	1/4"	4-20 LPM	463,00
FL3-5	1/4"	5-25 LPM	463,00
FL3-6	1/4"	6-30 LPM	463,00
FL3-10	1/2"	0,1-1m ³ /h	589,50
FL3-11	1/2"	0,6-6m ³ /h	589,50
FL3-15	1/2"	1-10m ³ /h	589,50
FL3-16	1/2"	1,6-16m ³ /h	589,50
FL3-17	1/2"	2,5-25m ³ /h	589,50
FL3-18	1/2"	4-40m ³ /h	589,50
FL3-19	1"	10-100m ³ /h	799,75
FL3-20	1"	20-100m ³ /h	799,75
FL3-21	1"	16-160m ³ /h	799,75
FL3-22	1"	25-250m ³ /h	799,75
FL3-23	1"	30-300m ³ /h	799,75

LPM = liter per minut,

m³/h = kubikmeter per time

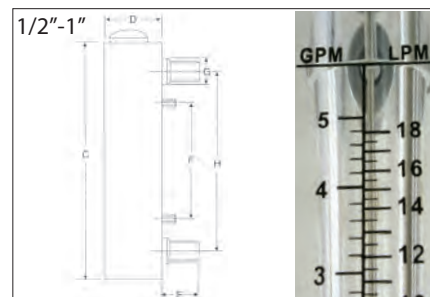
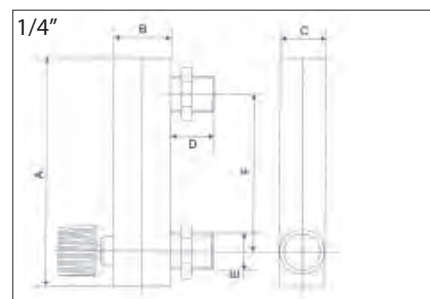

Flowmeter til væske

ACRYL - BSPP



½" - 1" = indv. gevind, resten er udv. gevind

Varenr.	BSPP	LPM	DKK
FL4-1	1/2"	0,5-4	589,50
FL4-2	1/2"	1-7	589,50
FL4-3	1/2"	1,8-18	589,50
FL4-4	3/4"	4-36	758,00
FL4-5	1"	10-70	842,25
FL4-6	1"	20-100	842,25
FL4-7	1"	20-150	842,25
FL4-8	1 1/2"	20-110	926,25
FL4-9	1 1/2"	20-150	926,25
FL4-10	1 1/2"	80-220	926,25
FL4-11	2"	80-300	2525,75
FL4-12	2"	80-360	2525,75
FL4-13	2"	150-450	2525,75
FL4-14	2"	190-560	2525,75
FL4-15	2"	220-750	2525,75

LPM = liter per minut

Flowmeter til luft

ACRYL - BSPP



½" - 1" = indv. gevind, resten er udv. gevind

Varenr.	BSPP	m ³ /h	DKK
FL5-1	1/2"	1-10	589,50
FL5-2	1/2"	1,6-16	589,50
FL5-3	1/2"	4-40	589,50
FL5-4	3/4"	6-60	758,00
FL5-5	1"	16-160	842,25
FL5-6	1"	25-250	842,25
FL5-7	1"	35-350	842,25
FL5-8	1 1/2"	25-250	926,25
FL5-9	1 1/2"	35-350	926,25
FL5-10	1 1/2"	80-400	926,25
FL5-11	2"	100-500	2525,75
FL5-12	2"	120-600	2525,75
FL5-13	2"	300-850	2525,75
FL5-14	2"	400-1200	2525,75
FL5-15	2"	500-1400	2525,75

m³/h = kubikmeter per time



Flowmeter

AB / ABS



0° til +60°C.

Limender. Drejelig for nem montering.

Varenr.	Dim	LPH	L	DKK
FL7-1	15	5-50	202	1445,25
FL7-2	15	10-100	202	1445,25
FL7-3	15	16-160	202	1445,25
FL7-4	15	25-250	202	1445,25
FL7-5	15	40-400	202	1445,25
FL7-6	15	50-500	202	1445,25
FL7-7	15	60-600	202	1445,25
FL7-8	15	100-1000	202	1445,25
FL7-9	25	100-1000	226	2089,00
FL7-10	25	160-1600	226	2089,00
FL7-11	25	250-2500	226	2089,00
m ³ /h				
FL7-13	32	0,4-4	288	2655,50
FL7-14	32	0,6-6	288	2655,50
FL7-15	50	1-10	341	3614,50
FL7-16	50	1,6-16	341	3614,50
FL7-17	65	2,5 - 16	430	5220,25
FL7-18	65	5-25	430	5220,25
FL7-19	65	8-40	430	5220,25
FL7-20	65	12-60	430	5220,25



Mix-stykke ACRYL - BSPT



Type Venturi.

Varenr.	BSPT	DKK
FL6-1	1/2"	386,25
FL6-2	3/4"	386,25
FL6-3	1"	386,25

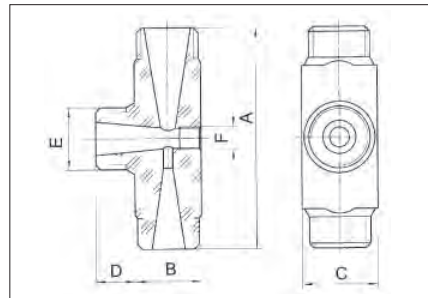

Flowmeter

AISI 304 - BSPP

0° til +200°C.

Drejelig for nem montering.

Varenr.	Dim	LPH	DKK
FL8-1	1/2"	4-40	4502,25
FL8-2	1/2"	6-60	4502,25
FL8-3	1/2"	10-100	4502,25
FL8-4	1/2"	16-160	4502,25
FL8-5	1/2"	25-250	4502,25
FL8-6	1/2"	40-400	4502,25
FL8-7	1/2"	63-630	4502,25
FL8-8	1"	63-630	5716,50
FL8-9	1"	100-1000	5716,50
FL8-10	1"	160-1600	5716,50
FL8-11	1"	250-2500	5716,50
FL8-12	1 1/2"	160-1600	7795,25
FL8-13	1 1/2"	250-2500	7795,25
FL8-14	1 1/2"	400-4000	7795,25
FL8-15	2"	400-4000	10655,50
FL8-16	2"	630-6300	10655,50
FL8-17	2"	1000-10000	10655,50

Flowindikator

SAN



Med spinner. Max 2 bar

Varenr.	Ø	farve	DKK
FL10-1	6-11mm	blå/blue	316,75
FL10-2	6-11mm	rød/red	316,75
FL10-3	6-11mm	sort/black	316,75



Digitalt flowmeter



Varenr.	BSPP	DKK
K23-1	1"	2654,50



INTERNETTET

Få login til vores hjemmeside og følg bedre med i nyheder. Vores hjemmeside opdateres løbende med nye produkter og nye tiltag i firmaet.

Produkterne er altid på hjemmesiden, før det nye katalog går i trykken. På den måde får vi afprøvet, om der er interesse for produkterne.

Du kan også læse om nye medarbejdere og om vores forhåbentlig fortsatte vækst, til gavn for dig som kunde. Flere produkter fra samme leverandør betyder besparede administrative omkostninger. Vores forpligtelse som professionel leverandør til vore kunder gør, at vi altid tænker på den bedst mulige service og kundebetjening; Gode priser og produkter til tiden.



WWW.ROYKON.DK

Google-søgning

Jeg prøver lykken

PLAST FITTINGS



194 GEVINDFITTINGS
PP SORT



198 GEVINDFITTINGS
NYLON 6.6 BLÅ



200 PUSH-ON FITTINGS
PP BLÅ



204 PUSH-ON FITTINGS
POM BLÅ



205 PUSH-ON FITTINGS
PP



206 PUSH-IN FITTINGS
POM



211 PVC RØR & TILBEHØR

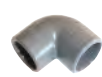

215 PVC LIMFITTINGS



222 PVC FLANGER



224 PVC GEVINDFITTINGS



228 PVC LIM &
GEVINDFITTINGS



232 ELEKTROSVEJS
FITTINGS PE



236 STUK-EL FITTINGS



238 STUK FITTINGS

GEVINDFITTINGS PP SORT



1/2" til 1 1/4": max 10bar
1 1/2" til 3": max 6bar



Max 70°C



Høj kvalitets sort polypropylen fittings med BSPP rørgvind. PP udmærker sig ved god bestandighed overfor aggressive medier og god slagfasthed.

PLASTFITTINGS

Vinkel 90° muf/muf PP (POLYPROPYLEN) - BSPP



Varenr.	BSPP	DKK
A121-4	1/2"	15,25
A121-5	3/4"	18,15
A121-6	1"	21,20
A121-7	1 1/4"	28,15
A121-8	1 1/2"	31,20
A121-9	2"	38,10
A121-10	2 1/2"	44,95
A121-11	3"	193,75
A121-12	4"	234,00

Vinkel 90° nip/nip PP (POLYPROPYLEN) - BSPP



Varenr.	BSPP	DKK
A122-4	1/2"	14,55
A122-5	3/4"	17,35
A122-6	1"	18,45
A122-7	1 1/4"	20,25
A122-8	1 1/2"	28,15
A122-9	2"	39,15

T-stk m. nipler PP (POLYPROPYLEN) - BSPP



Varenr.	BSPP	DKK
A123-4	1/2"	10,55
A123-5	3/4"	11,60
A123-6	1"	16,05
A123-7	1 1/4"	28,15
A123-8	1 1/2"	37,50
A123-9	2"	57,10

Vinkel 90° muf/nip PP (POLYPROPYLEN) - BSPP



Varenr.	BSPP	DKK
A120-4	1/2"	15,25
A120-5	3/4"	18,15
A120-6	1"	21,20
A120-7	1 1/4"	28,15
A120-8	1 1/2"	31,20
A120-9	2"	38,10

T-stk m. muffler PP (POLYPROPYLEN) - BSPP



Varenr.	BSPP	DKK
A126-4	1/2"	22,05
A126-5	3/4"	23,80
A126-5-1	3/4" x 1/2" x 3/4"	25,65
A126-6	1"	30,10
A126-7	1 1/4"	35,85
A126-8	1 1/2"	42,20
A126-9	2"	70,05
A126-10	2 1/2"	160,75
A126-11	3"	296,75
A126-12	4"	391,50



515

Brystnippel

PP (POLYPROPYLEN) - BSPP



Varenr.	BSPP	DKK
A128-4-2	1/2" x 1/4"	13,10
A128-4-3	1/2" x 3/8"	13,35
A128-4	1/2"	9,55
A128-5-3	3/4" x 3/8"	13,35
A128-5-4	3/4" x 1/2"	13,35
A128-5	3/4"	10,55
A128-6-4	1" x 1/2"	16,15
A128-6-5	1" x 3/4"	16,40
A128-6	1"	12,30
A128-7-5	1 1/4" x 3/4"	18,85
A128-7-6	1 1/4" x 1"	19,75
A128-7	1 1/4"	18,85
A128-8-6	1 1/2" x 1"	21,50
A128-8-7	1 1/2" x 1 1/4"	22,05
A128-8	1 1/2"	21,75
A128-9-7	2" x 1 1/4"	26,50
A128-9-8	2" x 1 1/2"	26,00
A128-9	2"	24,80
A128-10-9	2 1/2" x 2"	65,55
A128-10	2 1/2"	59,25
A128-11-9	3" x 2"	76,45
A128-11-10	3" x 2 1/2"	76,45
A128-11	3"	70,75
A128-12-11	4" x 3"	232,75
A128-12	4"	133,75

Brystnippel lang

PP (POLYPROPYLEN) - BSPP



Varenr.	BSPP	DKK
A141-4	1/2"	10,30
A141-5	3/4"	11,35

Nippelrør

PP (POLYPROPYLEN) - BSPP



Varenr.	BSPP	L	DKK
A127-5	3/4"	47mm	11,80
A127-6	1"	51mm	12,30
A127-6-1	1 1/4"	33,5mm	13,35
A127-7	1 1/4"	47,5mm	15,00
A127-8	1 1/2"	46mm	16,15
A127-9	2"	69mm	22,65

Skotgennemføring

PP (POLYPROPYLEN) - BSPP



Varenr.	BSPP	Ext. dim	DKK
A128G-4	1/2"	22 mm	12,30
A128G-5	3/4"	27 mm	13,35
A128G-6	1"	34 mm	15,25
A128G-7	1 1/4"	43 mm	21,50
A128G-8	1 1/2"	49 mm	24,50
A128G-9	2"	61 mm	27,15

NBI excl. kontramøtrik og pakning

Rørprop sekskant

PP (POLYPROPYLEN) - BSPP



Varenr.	BSPP	BSPT	DKK
A131-1	1/8"		11,90
A131-2	1/4"		7,70
A131-3	3/8"		9,90
A131-4	1/2"		8,00
A131-5	3/4"		8,45
A131-6	1"		10,55 □
A131-7	1 1/4"		13,10
A131-8	1 1/2"		12,50
A131-9	2"		15,20
A131-10	2 1/2"		37,10
A131K-10		2 1/2"	70,45
A131-11	3"		42,75

□ = neutral farve

Slutmuffe

PP (POLYPROPYLEN) - BSPP



Varenr.	BSPP	DKK
A130-3	3/8"	5,75
A130-4	1/2"	6,10
A130-5	3/4"	7,10
A130-6	1"	8,35
A130-7	1 1/4"	9,35
A130-8	1 1/2"	16,15
A130-9	2"	20,00
A130-10	2 1/2"	27,40
A130-11	3"	60,05
A130-12	4"	63,35

Muffe

PP (POLYPROPYLEN) - BSPP



Varenr.	BSPP	DKK
A133-4	1/2"	11,50
A133-5	3/4"	12,55
A133-6	1"	20,15
A133-7	1 1/4"	35,05
A133-8	1 1/2"	35,85
A133-9	2"	37,00
A133-10	2 1/2"	140,25
A133-11	3"	166,25

Formmuffe

PP (POLYPROPYLEN) - BSPP



Varenr.	BSPP	DKK
A133-4-2	1/2" x 1/4"	11,40
A133-4-3	1/2" x 3/8"	11,40
A133-5-3	3/4" x 3/8"	12,55
A133-5-4	3/4" x 1/2"	12,55
A133-6-4	1" x 1/2"	14,35
A133-6-5	1" x 3/4"	20,15
A133-7-5	1 1/4" x 3/4"	21,75
A133-7-6	1 1/4" x 1"	21,75
A133-8-6	1 1/2" x 1"	30,10
A133-8-7	1 1/2" x 1 1/4"	33,65
A133-9-6	2" x 1"	37,00
A133-9-7	2" x 1 1/4"	49,95
A133-9-8	2" x 1 1/2"	36,70
A133-10-9	2 1/2" x 2"	119,25
A133-11-9	3" x 2"	156,00
A133-11-10	3" x 2 1/2"	156,00
A133-12-11	4" x 3"	290,75

Nippelmuffe kort

PP (POLYPROPYLEN) - BSPP



Varenr.	BSPP	DKK
A132-5	3/4" x 1/2"	9,90
A132-6-4	1" x 1/2"	12,30
A132-6	1" x 3/4"	12,30
A132-7-4	1 1/4" x 1/2"	18,35
A132-7-5	1 1/4" x 3/4"	16,70
A132-7	1 1/4" x 1"	16,70
A132-8-4	1 1/2" x 1/2"	20,90
A132-8-5	1 1/2" x 3/4"	20,90
A132-8-6	1 1/2" x 1"	20,90
A132-8	1 1/2" x 1 1/4"	20,90
A132-9-4	2" x 1/2"	32,55
A132-9-5	2" x 3/4"	24,85
A132-9-6	2" x 1"	24,85
A132-9-7	2" x 1 1/4"	41,70
A132-9	2" x 1 1/2"	24,85
A132-10-9	2 1/2" x 2"	63,35
A132-11-6	3" x 1"	85,70
A132-11-7	3" x 1 1/4"	85,70
A132-11-8	3" x 1 1/2"	85,70
A132-11-9	3" x 2"	85,70
A132-11-10	3" x 2 1/2"	85,70
A132-12-9	4" x 2"	139,75
A132-12-11	4" x 3"	139,75

Spidsmuffe

PP (POLYPROPYLEN) - BSPP



Varenr.	BSPP	DKK
A134-3-2	3/8" x 1/4"	10,20
A134-4-2	1/2" x 1/4"	10,20
A134-4-3	1/2" x 3/8"	10,20
A134-5-3	3/4" x 3/8"	11,25
A134-5-4	3/4" x 1/2"	11,25
A134-6-4	1" x 1/2"	12,85
A134-6-5	1" x 3/4"	12,85
A134-7-5	1 1/4" x 3/4"	19,75
A134-7-6	1 1/4" x 1"	23,30
A134-8-6	1 1/2" x 1"	21,50
A134-8-7	1 1/2" x 1 1/4"	22,95
A134-9-8	2" x 1 1/2"	24,80
A134-10-9	2 1/2" x 2"	104,00
A134-11-9	3" x 2"	161,00
A134-11-10	3" x 2 1/2"	161,00
A134-12-11	4" x 3"	161,00

Nippelmuffe lang

PP (POLYPROPYLEN) - BSPP



Varenr.	BSPP	DKK
A135-5-4	3/4" x 1/2"	13,80
A135-6-4	1" x 1/2"	14,95
A135-6-5	1" x 3/4"	15,85
A135-7-4	1 1/4" x 1/2"	20,60
A135-7-5	1 1/4" x 3/4"	20,60
A135-7-6	1 1/4" x 1"	20,60
A135-8-6	1 1/2" x 1"	36,20
A135-8-7	1 1/2" x 1 1/4"	36,20
A135-9-6	2" x 1"	46,65
A135-9-7	2" x 1 1/4"	46,65
A135-9-8	2" x 1 1/2"	46,65
A135-10-9	2 1/2" x 2"	83,00
A135-11-9	3" x 2"	97,70
A135-11-10	3" x 2 1/2"	150,75
A135-12-11	4" x 3"	208,00

Spidsmuffe

PP (POLYPROPYLEN) - BSPP



Varenr.	BSPP	DKK
A134-4	1/2"	10,40
A134-5	3/4"	11,25
A134-6	1"	12,85
A134-7	1 1/4"	23,30
A134-8	1 1/2"	22,95
A134-9	2"	24,80

Afløbsstuds

PP (POLYPROPYLEN) - BSPP



Varenr.	BSPP	Gevind L	DKK
A137-4	1/2"	43	44,70
A137-5	3/4"	43	46,75
A137-6	1"	50	53,55
A137-7	1 1/4"	40	55,20
A137-8	1 1/2"	46	68,00
A137-9	2"	66	100,50
A137-10	2 1/2"	70	118,00

Kontramøtrik

PP (POLYPROPYLEN) - BSPP



Varenr.	BSPP	DKK
A129-3	3/8"	6,35
A129-4	1/2"	6,95
A129-5	3/4"	9,10
A129-6	1"	9,20
A129-7	1 1/4"	9,60
A129-8	1 1/2"	14,75
A129-9	2"	20,60
A129-10	2 1/2"	21,85
A129-11	3"	34,95

Fordeler m. nipler

PP (POLYPROPYLEN) - BSPT



Varenr.	BSPT	DKK
A51-1PP	1/2" x 3-1/2"	81,65

Fordeler muf/nip/nip/nip

PP (POLYPROPYLEN) - BSPP x BSPT



Varenr.	BSPP x BSPT	DKK
A51-2PP	1/2" x 3-1/2"	89,25

Kryds m. nipler

PP (POLYPROPYLEN) - BSPT



Varenr.	BSPT	DKK
A51-6PP	4-1/2"	81,65

Kryds muf/nip/nip/nip

PP (POLYPROPYLEN) - BSPP x BSPT



Varenr.	BSPP x BSPT	DKK
A51-7PP	1/2" x 3-1/2"	89,25

Fordeler

PA (POLYAMID) - BSPT



Varenr.	ind x ud	DKK
A51-8PA	1" x 3-3/4"	262,25
A51-9PA	1" x 6-3/4"	296,00

Pakning til udv. gevind

EPDM



Til flade pakflader

Varenr.	Dim	Ø/ø	- -	DKK
A139-4	1/2"	33/21	2	4,43
A139-5	3/4"	39,5/27,5	2,5	5,10
A139-6	1"	45/33	3	5,35
A139-7	1 1/4"	60/40	4	6,35
A139-8	1 1/2"	67/47	3	9,30
A139-9	2"	86/59	4	10,85
A139-10	2 1/2"	94,5/76	4	13,70
A139-11	3"	110/90	6	14,75



515

GEVINDFITTINGS NYLON 6.6 BLÅ



Max 10bar ved 20°C



Max 80°C



Serie af plast rørgvind fittings, passende til plast slangefittings, se under varenummer A1-1.

PLASTFITTINGS

Brystnippel

PA (POLYAMID) - BSPT



Varenr.	BSPT	DKK
A15-1	1/8"	12,30
A15-2	1/4"	13,80
A15-3	3/8"	15,55
A15-4	1/2"	17,90

Formmuffe

PA (POLYAMID) - BSPP



Varenr.	BSPP	DKK
A23-1	1/4" × 1/8"	15,00
A23-2	3/8" × 1/8"	15,55
A23-3	3/8" × 1/4"	16,40
A23-4	1/2" × 1/4"	24,50
A23-5	1/2" × 3/8"	25,35

Nippelmuffe

PA (POLYAMID) - BSPT×BSPP



Varenr.	BSPT×BSPP	DKK
A17-1	1/4" × 1/8"	14,60
A17-2	3/8" × 1/8"	17,35
A17-3	3/8" × 1/4"	18,15
A17-4	1/2" × 1/8"	27,15
A17-5	1/2" × 1/4"	28,15
A17-6	1/2" × 3/8"	28,70
A17-7	3/4" × 1/4"	36,20
A17-8	3/4" × 3/8"	37,00
A17-9	3/4" × 1/2"	37,85

Brystnippel reduktion

PA (POLYAMID) - BSPT



Varenr.	BSPT	DKK
A14-1	1/4" × 1/8"	12,30
A14-2	3/8" × 1/8"	15,55
A14-3	3/8" × 1/4"	16,40
A14-4-1	1/2" × 1/8"	16,75
A14-4	1/2" × 1/4"	17,90
A14-5	1/2" × 3/8"	18,85

Spidsmuffe

PA (POLYAMID) - BSPP×BSPT



Varenr.	BSPP×BSPT	DKK
A16-1	1/8"	15,00
A16-2	1/8" × 1/4"	15,55
A16-3	1/8" × 3/8"	17,35
A16-4	1/8" × 1/2"	18,15
A16-5	1/4" × 1/8"	15,00
A16-6	1/4"	16,40
A16-7	1/4" × 3/8"	17,35
A16-8	1/4" × 1/2"	19,15
A16-9	3/8" × 1/8"	17,35
A16-10	3/8" × 1/4"	18,15
A16-11	3/8"	19,15
A16-12	3/8" × 1/2"	19,75
A16-13	1/2" × 1/8"	27,15
A16-14	1/2" × 1/4"	28,15
A16-15	1/2" × 3/8"	28,70
A16-16	1/2"	29,50

Muffe

PA (POLYAMID) - BSPP



Varenr.	BSPP	DKK
A18-1	1/8"	14,60
A18-2	1/4"	15,55
A18-3	3/8"	19,15
A18-4	1/2"	28,15
A18-5	3/4"	26,00

Vinkel 90° nip/nip

PA (POLYAMID) - BSPT



Varenr.	BSPT	DKK
A19-1	1/8"	13,10
A19-2	1/4"	15,55
A19-3	3/8"	17,35
A19-4	1/2"	20,55

T-stk nip/nip red./nip

PA (POLYAMID) - BSPT



Varenr.	BSPT	DKK
A25-1	1/8" × 1/4" × 1/8"	22,95
A25-4	1/4" × 1/8" × 1/4"	22,95
A25-2	1/4" × 3/8" × 1/4"	28,70
A25-5	3/8" × 1/4" × 3/8"	28,70
A25-3	3/8" × 1/2" × 3/8"	38,90
A25-6	1/2" × 3/8" × 1/2"	38,90

Rørprop

PA (POLYAMID) - BSPP



Varenr.	BSPP	DKK
A21C-4	1/2"	18,45

Vinkel 90° nip/nip reduktion

PA (POLYAMID) - BSPT



Varenr.	BSPT	DKK
A20-1	1/4" × 1/8"	15,55
A20-2	3/8" × 1/4"	18,15
A20-3	1/2" × 3/8"	20,55

T-stk nip/nip/nip red.

PA (POLYAMID) - BSPT



Varenr.	BSPT	DKK
A26-4	1/8" × 1/8" × 1/4"	22,95
A26-1	1/4" × 1/4" × 1/8"	22,95
A26-5	1/4" × 1/4" × 3/8"	28,70
A26-2	3/8" × 3/8" × 1/4"	28,70
A26-6	3/8" × 3/8" × 1/2"	41,10
A26-3	1/2" × 1/2" × 3/8"	41,10

Slutmuffe

PA (POLYAMID) - BSPP



Varenr.	BSPP	DKK
A22-1	1/8"	10,65
A22-2	1/4"	11,50
A22-3	3/8"	14,10
A22-4	1/2"	15,00
A22-5	3/4"	18,15

T-stk m. nipler

PA (POLYAMID) - BSPT



Varenr.	BSPT	DKK
A24-1	1/8"	22,95
A24-2	1/4"	23,80
A24-3	3/8"	28,70
A24-4	1/2"	41,10

Rørprop

PA (POLYAMID) - BSPT



Varenr.	BSPT	DKK
A21-1	1/8"	7,50
A21-2	1/4"	8,25
A21-3	3/8"	9,15
A21-4	1/2"	9,95
	NPT	
A21-5	1/8"	7,50
A21-6	1/4"	8,25
A21-7	3/8"	9,15
A21-7-2	3/4"	20,25

Kontramøtrik

PA (POLYAMID) - BSPP



Varenr.	BSPP	DKK
A34-2	1/4"	9,50
A34-4	1/2"	11,85

PUSH-ON FITTINGS PP BLÅ



Max 14 bar ved 20°C



+4°C til +90°C



Hydraulisk system. Fremragende til indendørs og udendørs applikationer.

Fordele: Nem at tilslutte og særlig modstandsdygtighed over for kemikalier og gødning.

Denne serie af plast push-on fittings kan bruges sammen med serien af blå røgevind fittings.

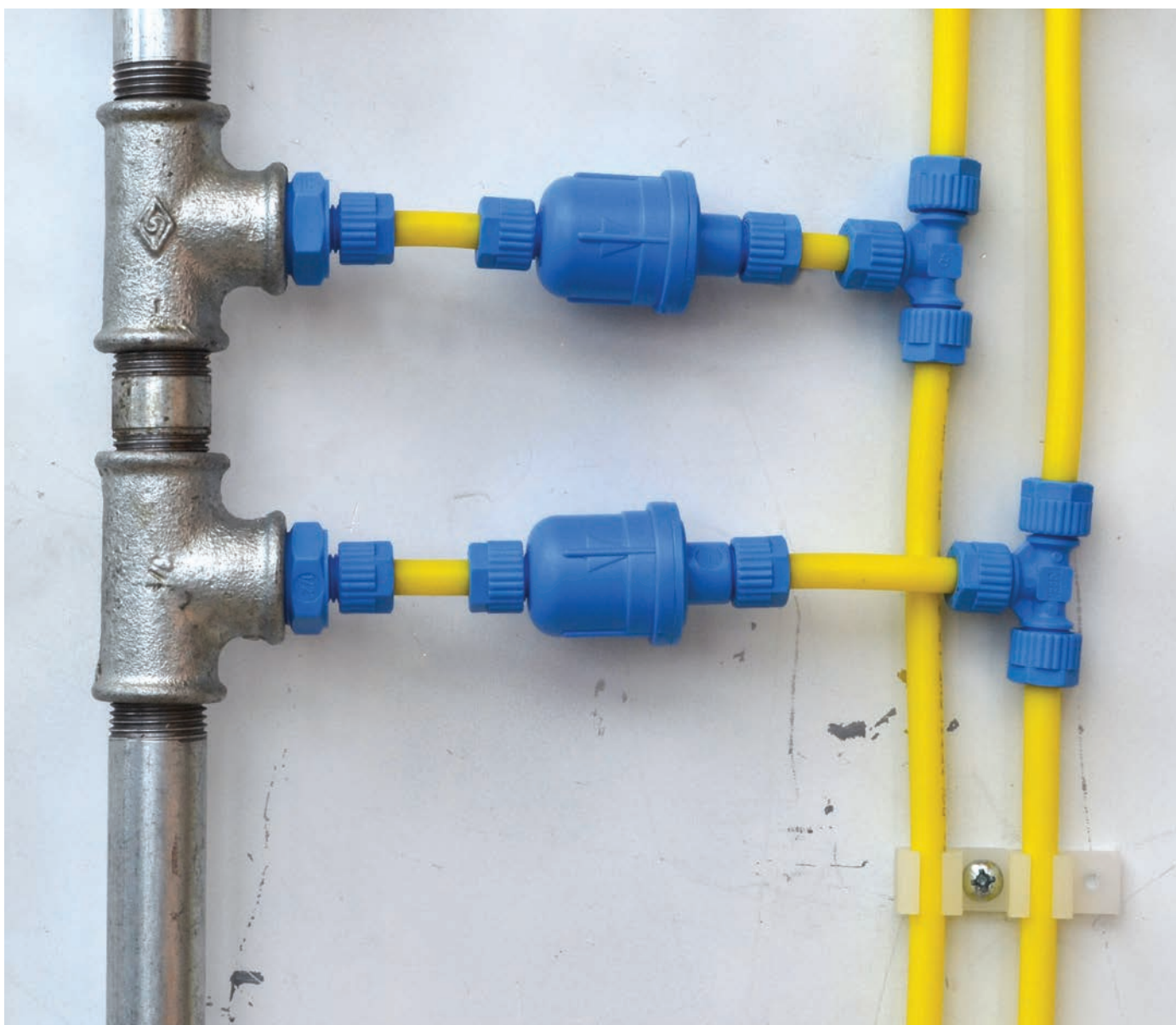

Ved push-on sættes slangen ned over en midterstuds med krave, der udvider slangen. Omløberens hul passer til den ikke-udvidede slange og klemmer derfor slangen fast, når den skrues på. Løsnes omløberen, kan slangen fjernes igen.

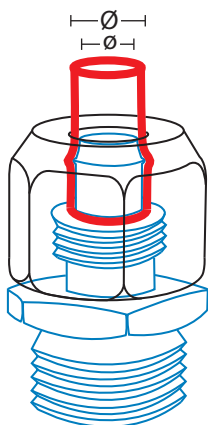

Nippel push-on PP (POLYPROPYLEN) - BSPT



Varenr.	Ø/ø × BSPT	DKK
A35-1	6/4 × 1/8"	19,10
A35-2	6/4 × 1/4"	19,10
A35-2-3	6/4 × 3/8"	19,90
A35-2-4	6/4 × 1/2"	34,50
A35-2-5	6/4 × 3/4"	36,20
A35-3	8/6 × 1/8"	22,75
A35-4	8/6 × 1/4"	22,75
A35-4-4	8/6 × 1/2"	34,50
A35-4-5	8/6 × 3/4"	38,60
A35-5	8/6 × 3/8"	24,35
A35-9	10/8 × 1/4"	33,90
A35-10	10/8 × 3/8"	36,45
A35-11	10/8 × 1/2"	36,45
A35-12	10/8 × 3/4"	36,45
A35-6	12/10 × 1/4"	25,50
A35-7	12/10 × 3/8"	32,00
A35-8	12/10 × 1/2"	32,00
A35-8-5	12/10 × 3/4"	33,60

Muffe push-on PP (POLYPROPYLEN) - BSPP



Varenr.	Ø/ø × BSPP	DKK
A36-1	6/4 × 1/8"	19,10
A36-2	6/4 × 1/4"	19,10
A36-3	8/6 × 1/8"	22,75
A36-4	8/6 × 1/4"	22,75
A36-5	8/6 × 3/8"	22,75
A36-6	8/6 × 1/2"	35,85
A36-7	10/8 × 1/4"	24,35
A36-8	10/8 × 3/8"	33,10
A36-9	10/8 × 1/2"	33,10

Muffe push-on m. omløber PP (POLYPROPYLEN) - BSPP



3/4" omløber med løs push-on studs til forskellige slangedimensioner.

Varenr.	Ø/ø × BSPP	DKK
A36L-1	1/4" × 3/4"	30,35
A36L-2	6/4 × 3/4"	30,35
A36L-3	8/6 × 3/4"	30,35
A36L-4	10/8 × 3/4"	36,95
A36L-5	12/10 × 3/4"	40,95

Union push-on PP (POLYPROPYLEN)



Varenr.	Ø/ø	DKK
A37-1	6/4	24,10
A37-2	8/6	27,00
A37-3	12/10	39,40

Union push-on red. PP (POLYPROPYLEN)



Varenr.	Ø/ø	DKK
A38-1	8/6 × 6/4	24,10

Vinkel 90° push-on PP (POLYPROPYLEN)



Varenr.	Ø/ø	DKK
A39-1	6/4	27,00
A39-2	8/6	27,00
A39-3	12/10	44,70

Vinkel 90° push-on/nippel PP (POLYPROPYLEN) - BSPT



Varenr.	Ø/ø × BSPT	DKK
A40-1	6/4 × 1/8"	24,10
A40-2	6/4 × 1/4"	24,10
A40-3	8/6 × 1/8"	26,70
A40-4	8/6 × 1/4"	26,70
A40-5	8/6 × 3/8"	32,85
A40-6	12/10 × 1/4"	41,45
A40-7	12/10 × 3/8"	41,45
A40-8	12/10 × 1/2"	41,45

Vinkel 90° push-on/muffe PP (POLYPROPYLEN) - BSPP

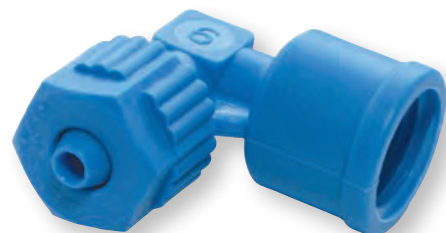

Varenr.	Ø/ø × BSPP	DKK
A49-1	6/4 × 1/8"	24,10
A49-2	6/4 × 1/4"	24,10
A49-3	8/6 × 1/4"	26,70

T-stk push-on PP (POLYPROPYLEN)



Varenr.	Ø/ø	DKK
A43-1	6/4	36,45
A43-2	8/6	37,25
A43-3	12/10	57,35

T-stk push-on/nippel ende PP (POLYPROPYLEN) - BSPT



Varenr.	BSPT × Ø/ø × Ø/ø	DKK
A42-1	1/8" × 6/4 × 6/4	30,65
A42-2	1/4" × 6/4 × 6/4	30,65
A42-3	1/8" × 8/6 × 8/6	36,45
A42-4	1/4" × 8/6 × 8/6	36,45
A42-5	3/8" × 8/6 × 8/6	38,35
A42-6	1/4" × 12/10 × 12/10	41,45
A42-7	3/8" × 12/10 × 12/10	54,05
A42-8	1/2" × 12/10 × 12/10	54,05

Banjobolt dobbelt PP (POLYPROPYLEN) - BSPT



Varenr.	BSPT	DKK
A46-1	1/8"	9,85
A46-2	1/4"	11,45

NB! excl. pakning

T-stk push-on/nippel gren PP (POLYPROPYLEN) - BSPT



Varenr.	Ø/ø × BSPT × Ø/ø	DKK
A41-1	6/4 × 1/8" × 6/4	30,10
A41-2	6/4 × 1/4" × 6/4	30,10
A41-3	8/6 × 1/8" × 8/6	32,85
A41-4	8/6 × 1/4" × 8/6	38,35
A41-5	8/6 × 3/8" × 8/6	35,85
A41-6	12/10 × 1/4" × 12/10	41,45
A41-7	12/10 × 3/8" × 12/10	50,75
A41-8	12/10 × 1/2" × 12/10	50,75

Banjonippel, 2 × push-on PP (POLYPROPYLEN)



Varenr.	Ø/ø × dim × Ø/ø	DKK
A44-1	6/4 × 1/8" × 6/4	27,90
A44-2	6/4 × 1/4" × 6/4	28,40
A44-3	8/6 × 1/8" × 6/4	30,65
A44-4	8/6 × 1/4" × 6/4	32,00
A44-5	8/6 × 1/8" × 8/6	30,65
A44-6	8/6 × 1/4" × 8/6	32,00

Banjobolt PP (POLYPROPYLEN) - BSPT



Varenr.	BSPT	DKK
A47-1	1/8"	5,85
A47-2	1/4"	6,45

NB! excl. pakning

Pakning til udv. gevind NYLON



Varenr.	dim	Ø/ø	- -	DKK
E16-29	M5	8,5/5	1	1,13
E16-20	1/8"	14/10,2	1	1,42
E16-21	1/4"	17,5/13,5	1,5	2,55
E16-22	3/8"	22/17,2	1,5	4,10
E16-23	1/2"	27/21,3	1,5	4,77
E16-24	3/4"	32/27	1,5	11,55
E16-25	1"	39/33,7	1,5	14,45
E16-26	1 1/4"	50/42,4	1,5	11,80
E16-27	1 1/2"	55/48,3	1,5	13,00
E16-28	2"	70/60,3	1,5	21,20

T-stk push-on/muffe gren PP (POLYPROPYLEN) - BSPP



Varenr.	Ø/ø × BSPP × Ø/ø	DKK
A52-1	6/4 × 1/8" × 6/4	30,65
A52-2	8/6 × 1/4" × 8/6	36,45

Banjonippel push-on PP (POLYPROPYLEN)



Varenr.	Ø/ø × BSPT	DKK
A45-1	6/4 × 1/8"	19,35
A45-2	6/4 × 1/4"	25,50
A45-3	8/6 × 1/8"	26,15
A45-4	8/6 × 1/4"	27,25

Vandfilter push-on

PP (POLYPROPYLEN)



Varenr.	Ø/ø	Mesh	DKK
A48-1	8/6	100	71,55

Vandfilter push-on

PP (POLYPROPYLEN)



Med kontraventil

Varenr.	Ø/ø	Mesh	DKK
A48-2	8/6	100	70,15

PUSH-ON FITTINGS POM BLÅ



Max 10bar ved 20°C samt vacuum.



Max 60°C



Serie af POM push-on fittings til særdel-se konkurrencedygtige priser. Kan bruges sammen med serien af blå rørgvind fittings.

POM er et ikke sugende materiale med god dimensional stabilitet og bruges derfor i produktionslinier med behov for præcis formstabilitet.

Ved push-on sættes slangen ned over en midterstuds med krave, der udvider slangen. Omløberens hul passer til den ikke-udvidede slange og klemmer derfor slangen fast, når den skrues på. Løsnes omløberen, kan slangen fjernes igen.

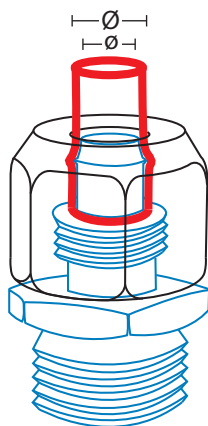

Nippel push-on

POM (ACETAL) - BSPT



Varenr.	Ø/ø × BSPT	DKK
AC35-060418	6/4 × 1/8"	5,65
AC35-060414	6/4 × 1/4"	6,10
AC35-080518	8/5 × 1/8"	6,10
AC35-080514	8/5 × 1/4"	7,55
AC35-080538	8/5 × 3/8"	8,25
AC35-106514	10/6,5 × 1/4"	8,75
AC35-106538	10/6,5 × 3/8"	8,75
AC35-120814	12/8 × 1/4"	8,75
AC35-120838	12/8 × 3/8"	8,75

T-stk push-on

POM (ACETAL)



Varenr.	Ø/ø	DKK
AC43-0604	6/4	14,60
AC43-0805	8/5	15,85
AC43-1065	10/6,5	17,10
AC43-1208	12/8	19,00

Vinkel 90° push-on/nippel

POM (ACETAL) - BSPT



Varenr.	Ø/ø × BSPT	DKK
AC40-060418	6/4 × 1/8"	8,10
AC40-060414	6/4 × 1/4"	9,15
AC40-080518	8/5 × 1/8"	8,10
AC40-080514	8/5 × 1/4"	9,15
AC40-080538	8/5 × 3/8"	11,70
AC40-106514	10/6,5 × 1/4"	12,65
AC40-106538	10/6,5 × 3/8"	12,65
AC40-120838	12/8 × 3/8"	12,65

PUSH-ON FITTINGS PP



10 bar



-5°C til +80°C



BDFAST er en ny meget spændende type fittings, der kan "tilpasse" sig forskellige slangetyper og tykkelser.

EPDM pakninger standard, men fås m. NBR, fødevarer NBR og VITON.

BDFAST kan bruges i: landbrug, gartneri og akvakultur, industri og byggeri, kemisk/petrokemisk industri, hydraulisk industri.

BDFAST anvendelsesområder:

- fittings for slangesystemer til transport af væsker, gas og damp
- fittings for slangesystemer til cirkulation af væsker i forskellige maskiner/apparater
- fittings for slangesystemer til vandbehandling

- fittings for slangesystemer til luft, pulvere, gasser osv.
- fittings for industrielt udstyr
- fittings for sugeanordninger
- fittings for forbindelser mellem ventiler

BDFAST, en revolution indenfor fittings

BDFAST er den ultimative opfindelse til slanger: kompressionfittings, som gør det muligt lynhurtigt at forbinde slanger og gør det normale spændebånd OVERFLØDIGT. BDFAST forbinder slanger af forskellig diameter og tykkelse, sikkert og simpelt, vha. en speciel indre samling, der tilpasser sig perfekt til praktisk taget alle slanger, der ligger indenfor fittingens tykkelsesområde. Egnet til slanger med plast eller stålspiral eller ren PVC. Uegnet til slanger med trådflet, f.eks. alm. trykluftslange.

BDFAST fordele

- glem spændebånd
- fleksibilitet: slanger kan have forskellige karakteristika og godstykkelser
- kort samle- og skilletid, uden specialværktøj, helt enkelt og nemt
- nem inspektion og udskiftning, takket være de få og simple komponenter
- det innovative system sikrer greb og hydraulisk tæthed
- neutralt, ugiftigt materiale

BDFAST præstationer

- skiller ikke, selv om slangen springer
- overlegen mekanisk styrke overfor tryk, træk og vridpåvirkninger
- polypropylen modstår termisk og mekanisk påvirkning, vind og vejr og UV stråling
- rustbestandig
- kan tilpasses en hvilken som helst væske, blot ved at skifte pakning

Nippel kompres

PP (POLYPROPYLEN) - BSPP



Varenr.	dim × BSPP	- -	DKK
AB60-6-30	30 × 1"	2,5 - 4,0	41,10 ₺
AB60-8-50	50 × 1 1/2"	3,6 - 5,0	77,20 ₺
AB60-9-60	60 × 2"	3,5 - 6,5	153,00 ₺

₺ = så længe lager haves

Muffe kompres

PP (POLYPROPYLEN) - BSPP



Varenr.	dim × BSPP	- -	DKK
AB61-5-20	20 × 3/4"	2,0 - 3,5	20,75 ₺
AB61-5-25	25 × 3/4"	2,0 - 3,5	21,90 ₺
AB61-6-25	25 × 1"	2,0 - 3,5	26,40 ₺
AB61-7-30	30 × 1 1/4"	2,5 - 4,0	46,20 ₺
AB61-7-32	32 × 1 1/4"	2,5 - 4,0	46,20 ₺
AB61-9-50	50 × 2"	3,6 - 5,0	86,10 ₺
AB61-9-60	60 × 2"	3,5 - 6,5	167,75 ₺

₺ = så længe lager haves



PUSH-IN FITTINGS POM



Se skema



-20°C til +60°C



Disse fittings er af ugiftig, harmløst materiale, der kan bruges i forbindelse med vand- og drikkevare systemer. Fødevaregodkendt.

Kan bruges til harmløse gasarter, væsker samt vacuum.

Fittings er fremstillet iht. ISO 9001 og systemets fordel er hurtig installation eller udskiftning. Stor fleksibilitet og mange anvendelsesmuligheder.

PLASTFITTINGS

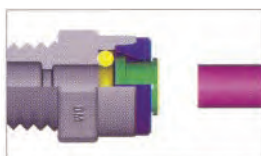

Afskær slange/rør retvinklet før indføring i fittings. Slangens/rørets ende skal være glat og ren uden dybe ridser.

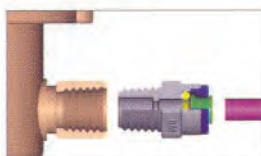

Fjern urenheder fra gevind og brug teflontape eller tilsvarende tætningsmateriale til tætning af gevind.

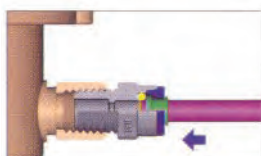

Selv om der føles modstand, skal det sikres at slangen/røret trykkes helt i bund. Brug kun fastnøglen til ispænding af fittings.

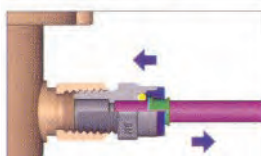

Kontroller korrekt montering ved at rykke i slange/rør.

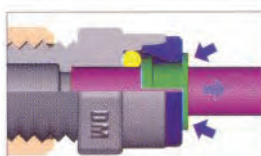

Afmontering: Pres kraven ind mod fittingsdelen og træk derefter i slangen/røret.



Den unikke ovale udførelse af kraven letter arbejdet.

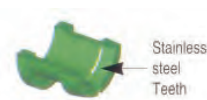

Acetal



Acetal



EPDM



Acetal

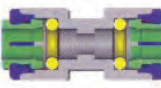

Samlet

Arbejstryk:

Dim	-20°C	0°C	20°C	60°C
4 mm	16 bar	16 bar	16 bar	10,5 bar
6 mm	16 bar	16 bar	16 bar	10,5 bar
8 mm	16 bar	16 bar	16 bar	10,5 bar
10 mm	11 bar	11 bar	11 bar	7 bar
12 mm	11 bar	11 bar	11 bar	7 bar
15 mm		12 bar	12 bar	7 bar
16 mm		12 bar	12 bar	7 bar
18 mm		15 bar	15 bar	9 bar
22 mm		15 bar	15 bar	9 bar

Fittings produceret efter følgende systemer/godkendelser:



Nippel push-in POM (ACETAL) - BSPT



Varenr.	dim × BSPT	DKK
AD80-1	ø4 × 1/8"	13,95
AD80-2	ø4 × 1/4"	15,45
AD80-3	ø5 × 1/8"	14,85
AD80-4	ø5 × 1/4"	15,85
AD80-5	ø6 × 1/8"	16,75
AD80-6	ø6 × 1/4"	16,75
AD80-7	ø6 × 3/8"	17,10
AD80-8	ø6 × 1/2"	20,55
AD80-9	ø8 × 1/8"	17,65
AD80-10	ø8 × 1/4"	17,65
AD80-11	ø8 × 3/8"	17,65 ^α
AD80-12	ø10 × 1/8"	18,35
AD80-13	ø10 × 1/4"	18,35
AD80-14	ø10 × 3/8"	18,35
AD80-15	ø10 × 1/2"	21,50
AD80-16	ø12 × 3/8"	21,75
AD80-17	ø12 × 1/2"	23,65
AD80-18	ø15 × 3/8"	56,00
AD80-19	ø15 × 1/2"	60,35
AD80-20	ø16 × 3/8"	60,35
AD80-21	ø16 × 1/2"	62,55
AD80-22	ø18 × 1/2"	64,45
AD80-23	ø22 × 3/4"	66,10

^α = så længe lager haves

Nippel push-in POM (ACETAL) - BSPP



Varenr.	dim × BSPP	DKK
AD81-1	ø4 × 1/8"	14,85
AD81-2	ø4 × 1/4"	16,45
AD81-3	ø5 × 1/8"	15,85
AD81-4	ø5 × 1/4"	15,85
AD81-5	ø6 × 1/8"	17,65
AD81-6	ø6 × 1/4"	17,65
AD81-7	ø8 × 1/8"	18,65
AD81-8	ø8 × 1/4"	18,65
AD81-9	ø8 × 3/8"	18,65
AD81-9-1	ø8 × 1/2"	28,15
AD81-10	ø10 × 1/4"	19,30
AD81-11	ø10 × 3/8"	19,30
AD81-12	ø10 × 1/2"	19,65
AD81-13	ø12 × 3/8"	22,75
AD81-14	ø12 × 1/2"	25,55
AD81-15	ø15 × 1/2"	60,35
AD81-16	ø15 × 3/4"	62,30
AD81-17	ø16 × 1/2"	67,75
AD81-18	ø16 × 3/4"	67,75
AD81-20	ø22 × 3/4"	67,75

Muffe push-in POM (ACETAL) - BSPP



Varenr.	dim × BSPP	DKK
AD82-1	ø6 × 1/8"	18,65
AD82-2	ø6 × 1/4"	18,65
AD82-5	ø6 × 1/2"	37,10
AD82-11	ø8 × 1/8"	20,75 ^α
AD82-12	ø8 × 1/4"	21,25
AD82-10	ø8 × 1/2"	23,05
AD82-4	ø10 × 1/4"	23,40
AD82-4-1	ø10 × 3/8"	23,80 ^α
AD82-6-1	ø12 × 3/8"	23,50
AD82-6-2	ø12 × 1/2"	23,75
AD82-7	ø15 × 1/2"	63,05
AD82-8	ø16 × 1/2"	64,95
AD82-9	ø22 × 3/4"	73,45

^α = så længe lager haves

Vinkel 90° push-in/nippel POM (ACETAL) - BSPT



Varenr.	dim × BSPT	DKK
AD83-01	ø4 × 1/8"	15,45 ^α
AD83-1	ø6 × 1/8"	16,75
AD83-2	ø6 × 1/4"	16,75 ^α
AD83-3	ø6 × 3/8"	17,40
AD83-4	ø10 × 1/4"	16,75
AD83-5	ø10 × 3/8"	17,40
AD83-7	ø12 × 1/2"	57,90
AD83-8	ø15 × 3/8"	57,90
AD83-9	ø15 × 1/2"	60,65
AD83-10	ø16 × 3/8"	60,05
AD83-11	ø16 × 1/2"	62,55

^α = så længe lager haves

Vinkel 90° push-in/nippel svivel

POM (ACETAL) - BSPT



Varenr.	dim × BSPT	DKK
AD84-1	ø4 × 1/8"	26,55
AD84-2	ø4 × 1/4"	26,90
AD84-3	ø5 × 1/8"	27,20
AD84-4	ø6 × 1/8"	28,70
AD84-5	ø6 × 1/4"	28,95
AD84-6	ø8 × 1/8"	31,50
AD84-7	ø8 × 1/4"	32,30
AD84-8	ø8 × 3/8"	32,55
AD84-9	ø10 × 1/4"	36,45
AD84-10	ø10 × 3/8"	37,25
AD84-11	ø12 × 3/8"	41,10
AD84-12	ø12 × 1/2"	41,70

Vinkel 90° push-in/rørende

POM (ACETAL) - BSPT



Varenr.	dim	DKK
AD85-1	ø4 × Ø4	15,20
AD85-2	ø5 × Ø5	15,85
AD85-3	ø6 × Ø6	16,75
AD85-4	ø6 × Ø10	20,90
AD85-5	ø8 × Ø8	18,65
AD85-6	ø8 × Ø10	20,90
AD85-7	ø10 × Ø10	22,50
AD85-8	ø12 × Ø12	26,55
AD85-9	ø15 × Ø15	63,05

Vinkel 90° push-in

POM (ACETAL)



Varenr.	dim	DKK
AD88-1	ø4	17,65
AD88-2	ø5	18,35
AD88-4	ø6	18,65
AD88-5	ø8 × ø4	19,30
AD88-6	ø8 × ø5	19,95
AD88-7	ø8 × ø6	20,90
AD88-8	ø8	21,20
AD88-9	ø10 × ø5	23,05
AD88-10	ø10 × ø6	23,40
AD88-11	ø10 × ø8	23,65
AD88-12	ø10	24,40
AD88-13	ø12 × ø10	27,20
AD88-14	ø12	27,45
AD88-15	ø15	102,50
AD88-16	ø16	104,75
AD88-17	ø18	124,25
AD88-18	ø22 × ø15	124,25
AD88-19	ø22 × ø16	133,00
AD88-20	ø22	142,75

Union push-in

POM (ACETAL)



Varenr.	dim	DKK
AD97-1	ø4	16,45
AD97-2	ø5	16,75
AD97-3	ø6	17,40
AD97-4	ø8 × ø5	21,75
AD97-5	ø8 × ø6	20,55
AD97-6	ø8	22,75
AD97-7	ø10 × ø5	22,15
AD97-8	ø10 × ø6	22,75
AD97-9	ø10 × ø8	23,05
AD97-10	ø10	23,40
AD97-11	ø12 × ø8	25,55
AD97-12	ø12 × ø10	26,30
AD97-13	ø12	26,55
AD97-14	ø15 × ø12	76,20
AD97-15	ø15	93,90
AD97-16	ø16 × ø12	84,10
AD97-17	ø16 × ø15	102,50
AD97-17-1	ø16 × ø16	102,50
AD97-18	ø18	109,50
AD97-19	ø22 × ø15	118,25
AD97-20	ø22	142,75

Vinkel 45° push-in red.

POM (ACETAL)



Varenr.	dim	DKK
AD86-1	ø10 × ø6	22,50
AD86-2	ø12 × ø8	23,65

T-stk push-in

POM (ACETAL)



Varenr.	dim	DKK
AD90-1	ø4	18,10
AD90-2	ø5	19,65
AD90-3	ø6	21,75
AD90-4	ø8	24,40
AD90-5	ø10 × ø6 × ø10	27,20
AD90-6	ø10	27,45
AD90-7	ø12 × ø10 × ø12	28,70
AD90-8	ø12	32,55
AD90-9	ø15	105,50
AD90-10	ø16	128,75
AD90-11	ø18	149,00
AD90-12	ø22	149,00

Nippel push-in/rørende

POM (ACETAL)



Varenr.	dim	DKK
AD96-1	ø4 × ø5	13,95
AD96-2	ø5 × ø6	14,15
AD96-3	ø4 × ø6	14,15
AD96-4	ø4 × ø8	14,60
AD96-5	ø5 × ø8	14,15
AD96-6	ø6 × ø8	14,60
AD96-7	ø6 × ø10	19,30
AD96-8	ø8 × ø10	19,95
AD96-9	ø8 × ø12	20,55
AD96-10	ø10 × ø12	26,90
AD96-11	ø10 × ø15	51,65
AD96-12	ø12 × ø15	56,00

Skotgennemføring push-in

POM (ACETAL)



Varenr.	dim	Ext. dim	DKK
AD98-1	ø4	M15*1	19,65 α
AD98-2	ø5	M16*1	20,90
AD98-3	ø6	M17*1,5	26,00
AD98-3-1	ø6 × ø4	M17*1,5	26,50 α
AD98-4	ø8	M20*1,75	26,90
AD98-4-1	ø8 × ø6	M20*1,75	27,60 α
AD98-6	ø10	M24*1,75	28,70
AD98-5	ø10 × ø6	M20*1,5	28,15
AD98-7	ø12	M27*2	37,50

α = så længe lager haves

Nippel m. rørende

POM (ACETAL) - BSPP



Varenr.	dim × BSPP	DKK
AD105C-1	Ø4 × 1/8"	9,55
AD105C-2	Ø4 × 1/4"	9,80
AD105C-3	Ø5 × 1/8"	10,00
AD105C-4	Ø5 × 1/4"	10,10
AD105C-5	Ø6 × 1/8"	10,45
AD105C-6	Ø6 × 1/4"	10,80
AD105C-7	Ø8 × 1/8"	11,10
AD105C-8	Ø8 × 1/4"	11,70
AD105C-9	Ø8 × 3/8"	12,15
AD105C-10	Ø10 × 1/4"	12,95
AD105C-11	Ø10 × 3/8"	13,95
AD105C-12	Ø10 × 1/2"	13,95
AD105C-13	Ø12 × 3/8"	14,60
AD105C-14	Ø12 × 1/2"	15,20
AD105C-15	Ø15 × 3/8"	28,15
AD105C-16	Ø15 × 1/2"	30,65
AD105C-17	Ø18 × 1/2"	59,25

Nippel m. rørende

POM (ACETAL) - BSPT



Varenr.	dim × BSPT	DKK
AD105K-1	Ø4 × 1/8"	9,55
AD105K-2	Ø4 × 1/4"	9,80
AD105K-3	Ø5 × 1/8"	10,00
AD105K-4	Ø5 × 1/4"	10,10
AD105K-5	Ø6 × 1/8"	10,45
AD105K-6	Ø6 × 1/4"	10,80
AD105K-7	Ø6 × 3/8"	11,55
AD105K-8	Ø8 × 1/8"	11,10
AD105K-9	Ø8 × 1/4"	11,70
AD105K-10	Ø8 × 3/8"	12,15
AD105K-11	Ø10 × 1/4"	12,95
AD105K-12	Ø10 × 3/8"	13,95
AD105K-13	Ø10 × 1/2"	13,95
AD105K-14	Ø12 × 3/8"	14,60
AD105K-15	Ø12 × 1/2"	15,20

Kryds push-in

POM (ACETAL)



Varenr.	dim	DKK
AD95-1	ø4	32,55
AD95-2	ø6	36,20
AD95-3	ø8	39,15
AD95-4	ø10	41,45
AD95-5	ø12	49,65

U-bøjning push-in

POM (ACETAL)



Varenr.	dim	DKK
AD112-1	ø6	20,90
AD112-2	ø8	25,30
AD112-3	ø10	26,55
AD112-4	ø12	28,15
AD112-5	ø15	49,95
AD112-6	ø16	59,50

Y-stk push-in

POM (ACETAL)



Varenr.	dim	DKK
AD111-1	ø4 × 2-ø4	22,75
AD111-2	ø6 × 2-ø6	25,30
AD111-3	ø8 × 2-ø8	26,55
AD111-4	ø10 × 2-ø8	29,25
AD111-5	ø10 × 2-ø10	27,65
AD111-6	ø12 × 2-ø12	32,55
AD111-7	ø10 × 2-ø12	31,20

Slangenippel m. rørende

POM (ACETAL)



Varenr.	A × B	DKK
AD110-1	Ø6 × Ø4	10,10
AD110-2	Ø8 × Ø6	11,45
AD110-3	Ø10 × Ø8	12,95
AD110-4	Ø12 × Ø10	13,05

Fordeler push-in

POM (ACETAL)



Varenr.	dim	DKK
AD109-1	ø10 × 3-ø6	59,50
AD109-2	ø12 × 3-ø10	68,25

Slutmuffe push-in

POM (ACETAL)



Varenr.	dim	DKK
AD108-2	ø5	6,35
AD108-3	ø6	6,35
AD108-4	ø8	6,65
AD108-5	ø10	7,20
AD108-6	ø12	7,90
AD108-7	ø15	19,80
AD108-8	ø22	33,10

Prop push-in

POM (ACETAL)



Varenr.	dim	DKK
AD99-1	Ø4	6,35
AD99-2	Ø5	6,35
AD99-3	Ø6	6,35
AD99-4	Ø8	6,65
AD99-5	Ø10	7,20
AD99-6	Ø12	7,90
AD99-7	Ø15	15,85
AD99-9	Ø18	19,00
AD99-10	Ø22	23,05

Filter push-in

POM (ACETAL)



Inkl. 100mesh filter

Varenr.	dim	DKK
AD116-3	ø6	117,75
AD116-4	ø8	124,75
AD116-5	ø10	134,50
AD116-6	ø12	142,75



Kontraventil push-in

POM (ACETAL)



Dobbeltvirkende

Varenr.	dim	DKK
AD122-1	ø15	182,25

Slangestuds push-in

POM (ACETAL)



Varenr.	dim × dim	DKK
AD123-1	ø15 × 1/2"	28,40
AD123-2	ø22 × 1/2"	32,30
AD123-3	ø22 × 3/4"	33,40

Kontraventil push-in

POM (ACETAL)



Varenr.	dim	DKK
AD113-3	ø6	147,25
AD113-4	ø8	157,75
AD113-5	ø10	176,50
AD113-6	ø12	196,75

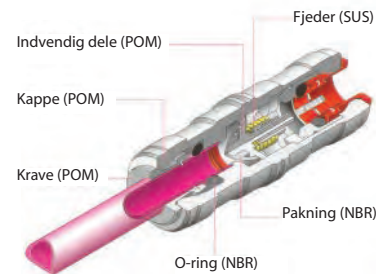

Ventil push-in

POM (ACETAL)



Varenr.	dim	DKK
AD120-6	ø6	87,65
AD120-8	ø8	87,65
AD120-0	ø10	89,60
AD120-12	ø12	96,95
AD120-1	ø15	132,50
AD120-2	ø15 × ø10	248,75
AD120-3	ø16	200,00
AD120-4	ø16 × ø10	200,00
AD120-5	ø22	248,75

Push-in sikkerhedsring



Varenr.	dim	DKK
AD125-00	ø4	1,44
AD125-01	ø6	3,14
AD125-1-1	ø8	3,36
AD125-1-1-0	ø10	3,69
AD125-1-2	ø12	3,69
AD125-1	ø15	2,37
AD125-2	ø16	2,37
AD125-4	ø22	2,37

Ventil 90° push-in/muffe

POM (ACETAL) - BSPP



Varenr.	dim × BSPP	DKK
AD115-3	ø6 × 1/4"	133,00
AD115-5	ø10 × 3/8"	170,25
AD115-7	ø12 × 1/2"	262,00

Ventil push-in

POM (ACETAL)



Varenr.	dim	DKK
AD121-1	ø15	65,55

Tankforbindelse push-in

POM (ACETAL)



Varenr.	dim	Ext. dim	DKK
AD126-1	ø15	M30*3,5	52,70
AD126-2	ø22	M39*3,5	60,05

PVC RØR & TILBEHØR



Max 16 bar



-20°C til +25°C,
dog ved <4 bar: 60°C



Se tekst



U-PVC er i bund og grund et af de bedste plast produkter, der anvendes til rør installationer.

U-PVC anvendes til hovedparten af plastrør i verden, som det er utroligt modstandsdygtige over for kemisk nedbrydning og har bløde indre vægge, som hjælper til at fremme vandgennemstrømning. Det fungerer også godt i et bredt temperaturområde og driftstryk. Det er et utrolig stærkt produkt, som gør det særligt egnet til brug i spildevand kredsløb og udvendige drænrør.

Egenskaber

U-PVC har mange gode egenskaber. Brandhæmmende, høj mekanisk styrke, god elektrisk isolationsevne. Den er modstandsdygtighed over for kemikalier og slid, er smagløs og lugter mindre, som gør den ideel til brug med drikkevand. Både fittings og rør er lette i vægt og fremstillet glatte, hvilket giver et fremragende flow, som mindsker bundfald og oplagring af snavs.

Anvendelsesområder

U-PVC rør og fittings kan anvendes indenfor landbrug, vanding, vandværker, kemiske installationer, vandbehandling og i swimmingpools.

U-PVC overholder gældende normer i Skandinavien, Tyskland, Holland, England, Frankrig og Italien, og kan anvendes sammen med rør fremstillet efter samme internationale standarder.

Standarder limfittings: ISO 727, DIN 8063, KIWA BRL-K 17301, EN ISO 1452
Standarder gevind fittings: ISO 7/1, DIN 2999, BS 21, UNI ISO 228/1.

ANVENDELSE for U-PVC fittings:

U-PVC fittings kan anvendes indenfor, landbrug, vanding, vandværker, kemiske installationer, vandbehandling og i swimmingpools.

Vores fittings kan anvendes sammen med rør fremstillet efter samme international standard. U-PVC overholder gældende standarder i Scandnavien, Tyskland, Holland, England, Frankrig og Italien.

MATERIALER:

Fittings: U-PVC polyvinyl chloride uden blødgøringsmiddel

Pakninger: EPDM

STANDARD:

Alle U-PVC limfittings er produceret i henhold til følgende internationale standarder:
ISO 727, DIN 8063, KIWA BRL-K 17301, EN ISO 1452.

Gevind fittings er fremstillet ifølge:

ISO 7/1, DIN 2999, BS 21, UNI ISO 228/1.

Certifikater:

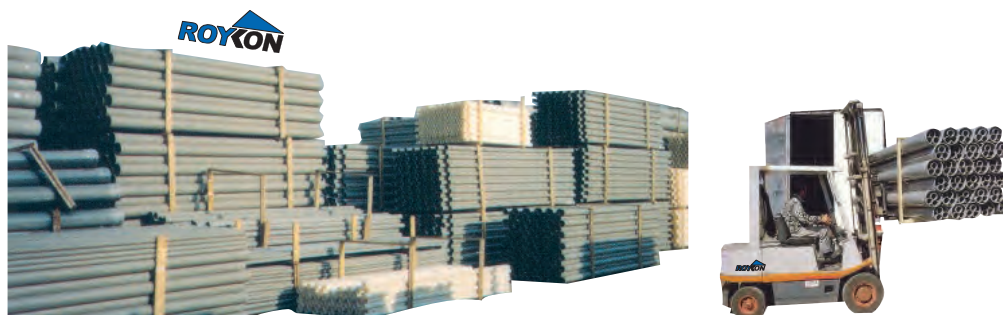
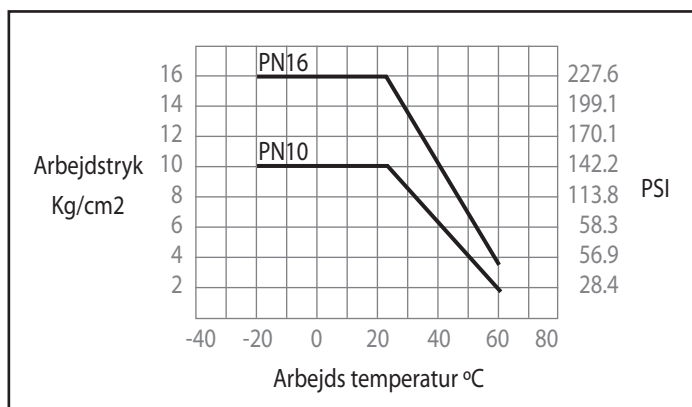

Trykrør PN6

U-PVC (POLYVINYLCHLORID)

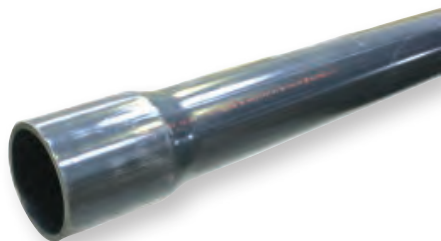

Med 1 klæbemuffe

Varenr.	dim	- -	L	DKK
AP6-75	Ø75	2,2	6m	300,25
AP6-90	Ø90	2,7	6m	396,50
AP6-110	Ø110	3,3	5m	488,50
AP6-125	Ø125	3,7	5m	522,75
AP6-140	Ø140	4,1	6m	1716,00
AP6-160	Ø160	4,7	5m	999,25
AP6-200	Ø200	5,9	5m	1521,50
AP6-225	Ø225	6,6	6m	3598,00
AP6-315	Ø315	9,2	5m	4838,00

Sælges kun i hele længder

Trykrør klar PN10 5m

U-PVC (POLYVINYLCHLORID)

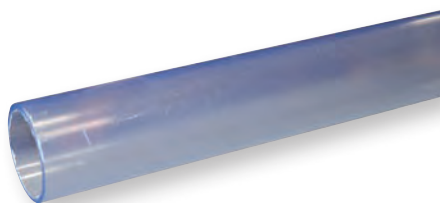

Uden klæbemuffe

Varenr.	dim	- -	Bar	DKK
APT1-25	Ø25	1,9	16	805,25
APT1-32	Ø32	1,8	10	1144,50
APT1-40	Ø40	2,0	10	1610,00
APT1-50	Ø50	2,4	10	1699,50
APT1-63	Ø63	3,0	10	2564,75

Sælges kun i hele længder

Rørholder til PVC rør

PP (POLYPROPYLEN)



Varenr.	ø	U	DKK
BR214-20	20	-	7,45
BR214-25	25	-	8,40
BR214-32	32	-	9,45
BR214-40	40	-	20,00
BR214-50	50	+	25,55
BR214-63	63	+	28,70
BR214-75	75	+	37,50
BR214-90	90	+	47,45
BR214-110	110	+	54,80

U = låsebøjle

Trykrør PN10

U-PVC (POLYVINYLCHLORID)

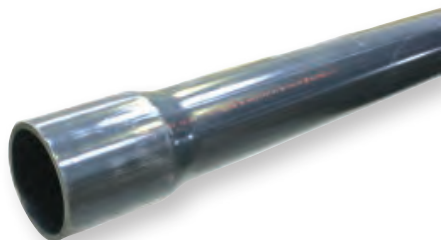

Med 1 klæbemuffe

Varenr.	dim	- -	L	DKK
AP1-25-1	Ø25	1,5	5m	51,65
AP1-32-1	Ø32	1,8	5m	73,70
AP1-40-1	Ø40	1,9	5m	108,00
AP1-50-1	Ø50	2,4	5m	179,00
AP1-63-1	Ø63	3,0	5m	277,25
AP1-75-1	Ø75	2,9	5m	394,50
AP1-90-1	Ø90	3,5	5m	565,00
AP1-110-1	Ø110	4,2	5m	685,25
AP1-125-1	Ø125	4,8	5m	910,50
AP1-140	Ø140	5,4	6m	1152,00
AP1-160-1	Ø160	6,2	5m	1462,75
AP1-200-1	Ø200	7,7	6m	3134,50
AP1-225-1	Ø225	8,6	6m	3424,75
AP1-250-1	Ø250	9,6	6m	4243,75
AP1-280-1	Ø280	13,4	6m	5285,00
AP1-315-1	Ø315	12,1	6m	6706,50

Sælges kun i hele længder

Trykrør PN16 5m

U-PVC (POLYVINYLCHLORID)

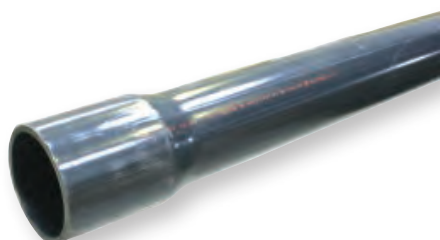

Med 1 klæbemuffe

Varenr.	dim	- -	L	DKK
AP1-12-1	Ø12	1,0	5m	28,40
AP1-16-1	Ø16	1,2	5m	51,25
AP1-20-1	Ø20	1,5	5m	51,65
AP1-25	Ø25	1,9	5m	97,85
AP1-32	Ø32	2,4	5m	141,75

Sælges kun i hele længder

Trykrør PN16 6m

U-PVC (POLYVINYLCHLORID)

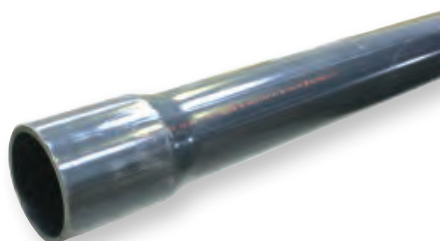

Med 1 klæbemuffe

Varenr.	dim	- -	L	DKK
AP4-125	Ø125	7,4	6m	1587,25 α
AP4-140	Ø140	8,3	6m	2009,75 α

α = så længe lager haves.

Sælges kun i hele længder.

Skydemuffe

U-PVC / O-RINGE = EPDM



Varenr.	ø	Kg	DKK
PA100-63	63	0,447	207,00
PA100-75	75	0,697	199,00
PA100-90	90	0,608	251,50
PA100-110	110	0,990	303,50
PA100-125	125	1,213	495,25
PA100-140	140	1,728	495,25
PA100-160	160	2,302	495,25
PA100-200	200	4,121	782,50

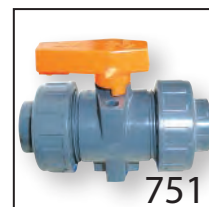

751



Skær røret i lige vinkel og afgrat rørenden.



Rens overfladen med Gymcol rengørings væske.



Smør PVC-lim ensartet og hurtigt rund på rørenden.



Smør PVC-lim ensartet og hurtigt indvendigt i fittings enden. Skub de 2 dele sammen. Træk eller vrid ikke i delene før efter ca. 10 minutter.



Med den nye type børste på-smøres PVC-limen mere ensartet og hurtigere. Sammenlignet med traditionelle børster spares der op til 50% i tid.



SIKKERHEDS DATABLADE LEVERES MED PRODUKTET

Lim (Gymcol)



Tolerance: 0,2 - 0,8mm mellemrum
Godkendt til drikkevandssystemer.
1 time tørring pr. bar ved +15°C.

Varenr.	Vol.	DKK
AL50-1	125 ml	50,30
AL50-2	250 ml	117,00
AL50-3	500 ml	259,00
AL50-4	1000 ml	304,00

Rengøringsvæske (Gymcol)



Godkendt til drikkevandssystemer		
Varenr.	Vol.	DKK
AL51-2	250 ml	73,70
AL51-3	500 ml	152,00
AL51-4	1000 ml	151,50

Unitec PVC-lim

Skær røret i lige vinkel og afgrat rørenden. Rengør med blødt papir.



Skub enderne sammen.



Drej enderne modsat hinanden.



Drej indtil modstand opnås.



Husk altid at positionere fittings korrekt i forhold til hinanden.



1 time/2 bars tryk
Herefter 1 bar pr.
time

PRODUKTBESKRIVELSE

Unitec PVC er et specialprodukt til limning af PVC. På basis af opløsningsmiddel NMP (N-Methyl-Pyrrolidon), som hærdes vha. vand, f.eks. fugten i luften. Unitec PVC er afprøvet og godkendt efter følgende standarder: DIN 16970 - ASTM D 2564-80 pkt. 6.3.3. - NS 2944 pkt. 6.4.

ANVENDELSE

Unitec PVC kan anvendes overalt, hvor PVC fittings kan anvendes. Uproblematisk ved hård PVC plast. Ved blød PVC plast skal hærdetiden fremskyndes, f.eks. ved at gennemskylle, duppe eller påføre vand. Ellers kan opløsningsmidlet opløse og deformere plasten. Unitec PVC leveres klar til brug. Må ikke blandes med andre lime, opløsningsmidler eller vand.

TEKNISKE DATA

Leveringsform: flydende

Farve: transparent

Viskositet: 15.000-20.000 mPa.s
(Brookfield RVT spindel 6, 20 rpm ved 23°C)

Tørstof: >18%

Densitet: 1,12g/ml

Kogepunkt: 202°C

Frysepunkt: -24°C

Flammepunkt: 95°C

Selvantændelsestemperatur: 346°C

ARBEJDSBETINGELSER (generelle)

Arbejdstemperatur:

0° til +80°C (optimalt +10° til +40°C)

Luftfugtighed:

30-80% RF (optimalt 50-70% RF)

Limmængde: Afhænger af rørdimension. Spalten mellem rør og fitting skal fyldes helt ud.

Hærdeforløb: Limen tåler 2 bar efter 1 time, 3 bar efter 2 timer, 4 bar efter 3 timer osv. op til rørets max. arbejdsstryk. Ved rør større end 65mm anbefales minimum 24 timer hærdning.

Rengøring:

På PVC tørres våd Unitec PVC af med tørt, sugende papir. Hud afvaskes med vand.

Opbevaring:

I tæt lukket emballage, køligt (ikke over 30°C), beskyttet mod sollys.

Lagrings-

tid: Som minimum holdbar 1 år fra produktionsdato.



Lim (Unitec)



Varenr.	Vol.	DKK
AL52-2	125 g	210,00
AL52-3-570	570 g	477,00

PVC LIMFITTINGS



Max 16 bar



-20°C til +25°C,
dog ved <4 bar: 60°C



Denne serie skal limes sammen.

U-PVC er i bund og grund et af de bedste plast produkter, der anvendes til rør installationer.

U-PVC har mange gode egenskaber. Brandhæmmende, høj mekanisk styrke, god elektrisk isolations evne. Den er modstandsdygtighed over for kemikalier og slid, er smagløs og lugter mindre, som gør den ideel til brug med drikkevand.

Både fittings og rør er lette i vægt og fremstillet glatte, hvilket giver et fremragende flow, som mindsker bundfald og oplagring af snavs.

U-PVC fittings kan anvendes indenfor landbrug, vanding, vandværker, kemiske installationer, vandbehandling og i swimmingpools.

U-PVC overholder gældende normer i Scandinavien, Tyskland, Holland, England, Frankrig og Italien, og kan anvendes sammen med rør fremstillet efter samme international standarder.

Standarder limfittings: ISO 727, DIN 8063, KIWA BRL-K 17301, EN ISO 1452
Standarder gevind fittings: ISO 7/1, DIN 2999, BS 21, UNI ISO 228/1.

Bøjning 90° lang lim/lim

U-PVC (POLYVINYLCHLORID)



Varenr.	Indv.	Udv.	DKK
AL38-20	20	28	27,25
AL38-25	25	35	32,00
AL38-32	32	42	40,25
AL38-40	40	51	54,05
AL38-50	50	63	76,45
AL38-63	63	77	101,75
AL38-75	75	94	222,00
AL38-90	90	113	278,00
AL38-110	110	132	475,25

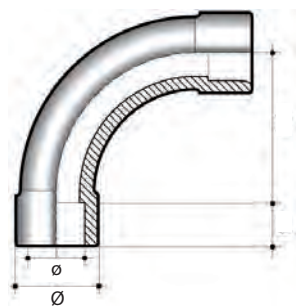

Nippelmuffe 90° lim/lim

U-PVC (POLYVINYLCHLORID)



Varenr.	dim	DKK
AL4-5050	ø50 × Ø50	33,65
AL4-6363	ø63 × Ø63	49,95

Vinkel 90° lim/lim

U-PVC (POLYVINYLCHLORID)



Varenr.	Indv.	Udv.	DKK
AL1-16	16	23,5	6,05
AL1-20	20	26,5	6,80
AL1-25	25	32,5	7,95
AL1-32	32	41	9,45
AL1-40	40	50	16,20
AL1-50	50	60	23,45
AL1-63	63	75	33,10
AL1-75	75	89	72,65
AL1-90	90	106	94,20
AL1-110	110	129	140,25
AL1-125	125	145	287,00
AL1-140	140	164	350,50
AL1-160	160	188	545,00
AL1-200	200	232	1052,75
AL1-225	225	258	1191,75
AL1-250	250	286	1511,25
AL1-280	280	318	2117,75
AL1-315	315	358	2603,00

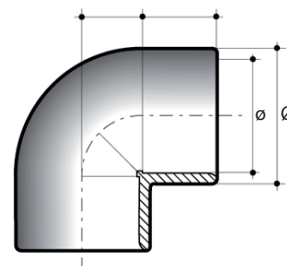

T-stk m. lim ender
U-PVC (POLYVINYLCHLORID)



Varenr.	Indv.	Udv.	DKK
AL2-16	16	23,5	7,30
AL2-20	20	27,5	7,95
AL2-25	25	33,5	9,55
AL2-32	32	42	12,85
AL2-40	40	51	20,75
AL2-50	50	61	28,95
AL2-63	63	75	42,20
AL2-75	75	89	80,00
AL2-90	90	106	113,50
AL2-110	110	129,5	185,25
AL2-125	125	145	381,75
AL2-140	140	162,5	527,50
AL2-160	160	188	626,25
AL2-200	200	232	1162,00
AL2-225	225	258	1300,00
AL2-250	250	286	1632,75
AL2-280	280	319	2117,75
AL2-315	315	360	3022,25

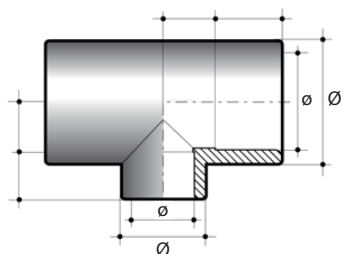
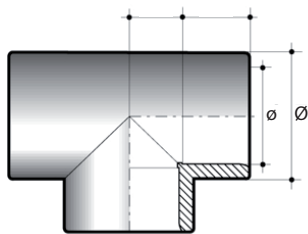

T-stk red. m. lim ender
U-PVC (POLYVINYLCHLORID)



Varenr.	Indv.	Udv.	DKK
AL2-20-16	20x16x20	27,5x23,5x27,5	7,95
AL2-25-16	25x16x25	33,5x23,5x33,5	9,80
AL2-25-20	25x20x25	33,5x28x33,5	9,80
AL2-32-16	32x16x32	42x23,5x42	12,85
AL2-32-20	32x20x32	42x28x42	12,85
AL2-32-25	32x25x32	42x33,5x42	12,85
AL2-40-16	40x16x40	51x23,5x51	20,75
AL2-40-20	40x20x40	51x28x51	20,75
AL2-40-25	40x25x40	51x33,5x51	20,75
AL2-40-32	40x32x40	51x42x51	20,75
AL2-50-20	50x20x50	61x28x61	28,95
AL2-50-25	50x25x50	61x33,5x61	28,95
AL2-50-32	50x32x50	61x42x61	28,95
AL2-50-40	50x40x50	61x51x61	28,95
AL2-63-20	63x20x63	75x28x75	44,70
AL2-63-25	63x25x63	75x33,5x75	44,70
AL2-63-32	63x32x63	75x42x75	44,70
AL2-63-40	63x40x63	75x51x75	44,70
AL2-63-50	63x50x63	75x61x75	44,70
AL2-75-32	75x32x75	89x42x89	83,00
AL2-75-40	75x40x75	89x51x89	83,00
AL2-75-50	75x50x75	89x61x89	83,00
AL2-75-63	75x63x75	89x75x89	83,00
AL2-90-40	90x40x90	106x51x106	121,25
AL2-90-50	90x50x90	106x61x106	121,25
AL2-90-63	90x63x90	106x61x106	121,25
AL2-90-75	90x75x90	106x89x106	121,25
AL2-110-50	110x50x110	129x61x129	187,50
AL2-110-63	110x63x110	129x75x129	187,50
AL2-110-75	110x75x110	129x89x129	187,50
AL2-110-90	110x90x110	129x106x129	187,50
AL2-125-63	125x63x125	148x75x148	499,00
AL2-125-75	125x75x125	148x89x148	499,00
AL2-125-90	125x90x125	148x106x148	499,00
AL2-125-110	125x110x125	148x129x148	499,00
AL2-140-75	140x75x140	163x89x163	623,00
AL2-140-90	140x90x140	163x106x163	623,00
AL2-140-110	140x110x140	163x129x163	623,00
AL2-140-125	140x125x140	163x148x163	623,00
AL2-160-90	160x90x160	184x106x184	690,00
AL2-160-110	160x110x160	184x129x184	690,00
AL2-160-125	160x125x160	184x148x184	690,00
AL2-160-140	160x140x160	184x163x184	690,00

T-bøjning m. lim ender
U-PVC (POLYVINYLCHLORID)



Varenr.	dim	DKK
AL7-5050	50mm	73,15
AL7-6363	63mm	105,75

Kryds m. lim ender
U-PVC (POLYVINYLCHLORID)



Varenr.	Indv.	Udv.	DKK
AL3-20	20	27,5	19,45
AL3-25	25	33,5	24,15
AL3-32	32	42	27,90
AL3-40	40	51	41,95
AL3-50	50	61	51,90
AL3-63	63	75	76,70
AL3-75	75	89	154,50
AL3-90	90	106	272,50
AL3-110	110	129,5	514,25

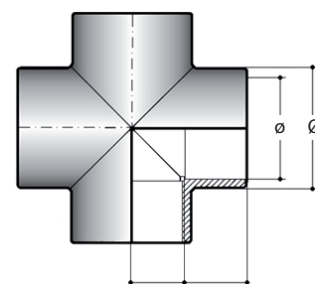

Vinkel 45° lim/lim
U-PVC (POLYVINYLCHLORID)



Varenr.	Indv.	Udv.	DKK
AL5-16	16	23	10,45
AL5-20	20	28	11,05
AL5-25	25	34	12,00
AL5-32	32	42	16,30
AL5-40	40	51	20,75
AL5-50	50	61	26,05
AL5-63	63	75	40,85
AL5-75	75	89	66,60
AL5-90	90	106	91,75
AL5-110	110	128	199,25
AL5-125	125	145	260,50
AL5-140	140	164	315,00
AL5-160	160	184	378,75
AL5-200	200	232	886,50
AL5-225	225	258	959,00
AL5-250	250	287	1210,25
AL5-280	280	320	1663,50
AL5-315	315	360	2299,00

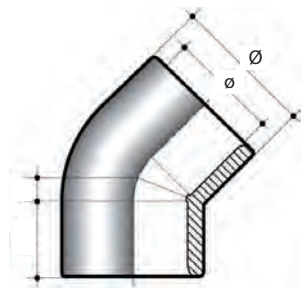

Nippelmuffe 45° lim/lim
U-PVC (POLYVINYLCHLORID)



Varenr.	Indv.	Udv.	DKK
AL5U-5050	50	50	38,90
AL5U-6363	63	63	58,15

Y-stk m. lim ender
U-PVC (POLYVINYLCHLORID)

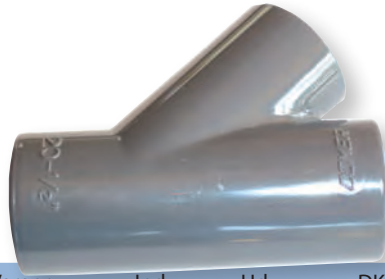

Varenr.	Indv.	Udv.	DKK
AL5Y-20	20	27,5	23,20
AL5Y-25	25	33,5	28,40
AL5Y-32	32	42	32,85
AL5Y-40	40	50,5	43,60
AL5Y-50	50	61	56,85
AL5Y-63	63	84,5	78,35
AL5Y-75	75	89	282,75
AL5Y-90	90	106	423,00
AL5Y-110	110	129	882,25

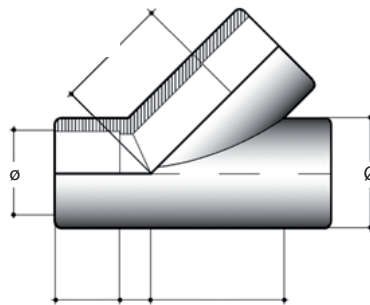

Slangenippel m. lim ende
U-PVC (POLYVINYLCHLORID)



Varenr.	Ø	DKK
AL14-12	12 × 12	5,15
AL14-16	16 × 16	6,05
AL14-20	20 × 20	7,95
AL14-25	25 × 25	9,25
AL14-32	32 × 32	10,45
AL14-40	40 × 40	12,85
AL14-50	50 × 50	18,45
AL14-63	63 × 63	30,35

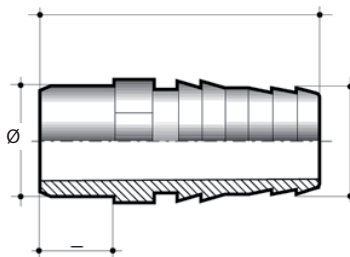

Union flad lim/lim
U-PVC (POLYVINYLCHLORID) / EPDM



Varenr.	dim	NT	DKK
AL6-16	16mm	3/4"	21,95
AL6-20	20mm	1"	22,55
AL6-25	25mm	1 1/4"	26,05
AL6-32	32mm	1 1/2"	35,05
AL6-40	40mm	2"	44,15
AL6-50	50mm	2 1/4"	57,60
AL6-63	63mm	2 3/4"	80,55
AL6-75	75mm	3 1/2"	247,50
AL6-90	90mm	4"	288,00
AL6-110	110mm	5"	329,00

NT = omløbergevind

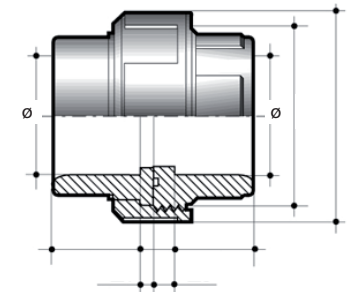



Union indlægsdel

U-PVC (POLYVINYLCHLORID)



Varenr.	dim	DKK
AL6-16-2	16mm	5,50 α
AL6-20-2	20mm	6,05 α
AL6-25-2	25mm	6,80 α
AL6-32-2	32mm	9,25 α
AL6-40-2	40mm	11,05 α
AL6-50-2	50mm	14,45 α
AL6-63-2	63mm	20,75 α
AL6-75-2	75mm	55,45 α
AL6-90-2	90mm	67,20 α
AL6-110-2	110mm	80,25 α

α = så længe lager haves

Union O-ring/pakning

EPDM



Varenr.	dim	DKK
AL6-16-O	16mm	3,19 α
AL6-20-O	20mm	3,19 α
AL6-32-O	32mm	3,86 α
AL6-40-O	40mm	6,80 α
AL6-50-O	50mm	8,90 α
AL6-75-O	75mm	12,45 α
AL6-90-O	90mm	12,85 α
AL6-110-O	110mm	25,65 α

α = så længe lager haves

Union omløber

U-PVC (POLYVINYLCHLORID)



Varenr.	dim	NT	DKK
AL6-16-1	16mm	3/4"	8,90 α
AL6-20-1	20mm	1"	9,55 α
AL6-25-1	25mm	1 1/4"	10,45 α
AL6-50-1	50mm	2 1/4"	24,15 α
AL6-110-1	110mm	5"	145,00 α

NT = omløbergevind

α = så længe lager haves

Union gevinddel

U-PVC (POLYVINYLCHLORID)



Varenr.	dim	NT	DKK
AL6-16-3	16mm	3/4"	7,30 α
AL6-25-3	25mm	1 1/4"	9,80 α
AL6-40-3	40mm	2"	16,30 α
AL6-110-3	110mm	5"	103,75 α

NT = omløbergevind

α = så længe lager haves

Slutmuffe rund til lim

U-PVC (POLYVINYLCHLORID)



Varenr.	Indv.	Udv.	DKK
AL16-16	16	23	4,80
AL16-20	20	28	5,50
AL16-25	25	33	6,15
AL16-32	32	41	7,30
AL16-40	40	50	10,45
AL16-50	50	60,5	14,45
AL16-63	63	75	20,05
AL16-75	75	89	46,65
AL16-90	90	106	63,90
AL16-110	110	129	91,20
AL16-125	125	145	155,50
AL16-140	140	161	166,50
AL16-160	160	181	233,75
AL16-200	200	227	665,25
AL16-225	225	254	737,75

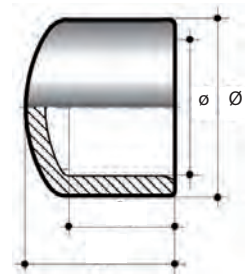

Slutmuffe flad til lim

U-PVC (POLYVINYLCHLORID)



Varenr.	Indv.	DKK
AL17-25	25	6,15
AL17-32	32	7,30
AL17-40	40	10,45
AL17-50	50	14,45
AL17-63	63	20,05

Muffe lim/lim

U-PVC (POLYVINYLCHLORID)



Varenr.	Indv.	Udv.	DKK
AL22-16	16	23,5	5,50
AL22-20	20	28	5,50
AL22-25	25	34	5,80
AL22-32	32	42	6,15
AL22-40	40	51	9,80
AL22-50	50	61	12,85
AL22-63	63	75	17,25
AL22-75	75	88	41,45
AL22-90	90	106	69,35
AL22-110	110	128	95,80
AL22-125	125	145	158,00
AL22-140	140	161	206,75
AL22-160	160	181	244,25
AL22-200	200	226	586,25
AL22-225	225	258	671,25
AL22-250	250	287	960,00
AL22-280	280	320	1320,00
AL22-315	315	355	1567,00

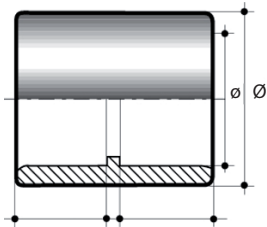

Formmuffe lim/lim

U-PVC (POLYVINYLCHLORID)

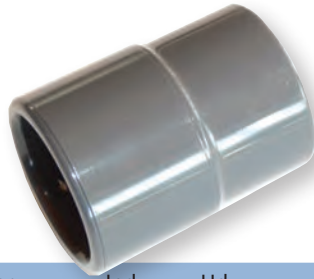

Varenr.	Indv.	Udv.	DKK
AL18-2016	20×16	28×23	5,50
AL18-2520	25×20	34×28	6,15
AL18-3225	32×25	42×33	8,50
AL18-4032	40×32	51×41	11,05
AL18-5040	50×40	61×50	15,05
AL18-6350	63×50	75×60,5	21,25
AL18-7563	75×63	89×75	42,20
AL18-9075	90×75	106×88	68,50
AL18-11090	110×90	129×106	103,00
AL18-125110	125×110	145×128	164,00
AL18-140110	140×110	160×128	206,75
AL18-140125	140×125	160×145	252,75
AL18-160110	160×110	180×129	345,75
AL18-160140	160×140	184×164	345,75
AL18-200160	200×160	226×180	710,00
AL18-225200	225×200	258×227	780,50

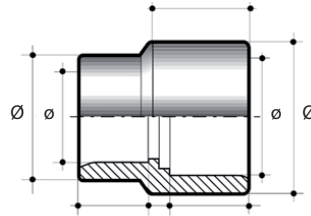

Nippelmuffe lim/lim

U-PVC (POLYVINYLCHLORID)

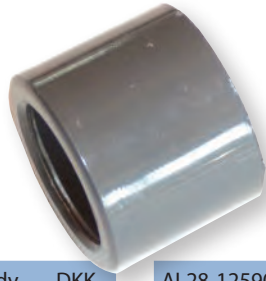

Varenr.	Udv.	Indv.	DKK
AL28-2016	20	16	4,52
AL28-2516	25	16	5,50
AL28-2520	25	20	5,50
AL28-3216	32	16	6,80
AL28-3220	32	20	6,80
AL28-3225	32	25	6,80
AL28-4020	40	20	7,70
AL28-4025	40	25	7,70
AL28-4032	40	32	7,70
AL28-5025	50	25	8,90
AL28-5032	50	32	8,90
AL28-5040	50	40	8,90
AL28-6325	63	25	14,00
AL28-6332	63	32	14,00
AL28-6340	63	40	14,00
AL28-6350	63	50	14,00
AL28-7532	75	32	23,20
AL28-7540	75	40	23,20
AL28-7550	75	50	23,20
AL28-7563	75	63	23,20
AL28-9050	90	50	37,50
AL28-9063	90	63	37,50
AL28-9075	90	75	37,50
AL28-11063	110	63	53,80
AL28-11075	110	75	53,80
AL28-11090	110	90	53,80
AL28-12575	125	75	100,50

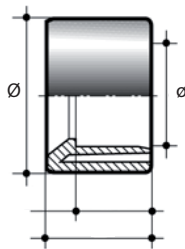

Formmuffe lim/lim

U-PVC (POLYVINYLCHLORID)



Varenr.	Indv.	Udv.	DKK
AL19-202516	20×16	25×23	6,05
AL19-202520	20	28×25	6,05
AL19-253216	25×16	32×23	6,80
AL19-253220	25×20	32×28	6,80
AL19-253225	25	33×32	6,80
AL19-324020	32×20	40×28	8,40
AL19-324025	32×25	40×33	8,40
AL19-324032	32	41×40	8,40
AL19-405020	40×20	50×28	11,05
AL19-405025	40×25	50×33	11,05
AL19-405032	40×32	50×41	11,05
AL19-405040	40	50	11,05
AL19-506325	50×25	63×33	16,30
AL19-506332	50×32	63×41	16,30
AL19-506340	50×40	63×50	16,30
AL19-506350	50	63×60,5	16,30
AL19-637540	63×40	75×50	27,65
AL19-637550	63×50	75×60,5	27,65
AL19-637563	63	75	27,65
AL19-759040	75×40	90×50	46,05
AL19-759050	75×50	90×60,5	46,05
AL19-759063	75×63	90×75	46,05
AL19-759075	75	90×88	46,05
AL19-9011040	90×40	110×50	68,50
AL19-9011050	90×50	110×60,5	68,50
AL19-9011063	90×63	110×75	68,50
AL19-9011075	90×75	110×88	68,50
AL19-9011090	90	110×106	68,50
AL19-11012550	110×50	125×60,5	102,75
AL19-11012563	110×63	125×75	102,75
AL19-11012575	110×75	125×88	102,75
AL19-11012590	110×90	125×106	102,75
AL19-110125110	110	129×125	102,75
AL19-12514090	125×90	140×106	162,75
AL19-125140110	125×110	140×129	162,75
AL19-125140125	125	145×140	162,75
AL19-14016090	140×90	160×106	206,75
AL19-140160110	140×110	160×129	206,75
AL19-140160125	140×125	160×145	252,75
AL19-140160140	140	164×160	282,75

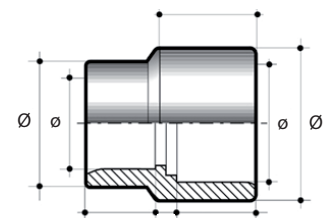

Fordeler m. lim ender

U-PVC (POLYVINYLCHLORID)



Varenr.	ind x ud	DKK
AL20-1	3-ø50 x 3-Ø50	209,00

3 ind (ender+top), 3 ud (bund)

Skueglas til lim

U-PVC (POLYVINYLCHLORID)



Varenr.	ø	DN	DKK
AH18-1	40mm	50	669,50
AH18-2	50mm	50	734,75
AH18-3	63mm	50	867,50
AH18-4	90mm	100	2501,00
AH18-5	110mm	100	2797,50
AH18-6	125mm	100	3361,00
AH18-7	110mm	125	4060,50
AH18-8	125mm	125	5886,50
AH18-9	140mm	125	6201,75
AH18-10	160mm	125	6863,00

Lim (Gymcol)



Tolerance: 0,2 - 0,8mm mellemrum
Godkendt til drikkevandssystemer.
1 time tørring pr. bar ved +15°C.

Varenr.	Vol.	DKK
AL50-1	125 ml	50,30
AL50-2	250 ml	117,00
AL50-3	500 ml	259,00
AL50-4	1000 ml	304,00

Rengøringsvæske (Gymcol)



Godkendt til drikkevandssystemer

Varenr.	Vol.	DKK
AL51-2	250 ml	73,70
AL51-3	500 ml	152,00
AL51-4	1000 ml	151,50

Lim (Unitec)



Varenr.	Vol.	DKK
AL52-2	125 g	210,00
AL52-3-570	570 g	477,00



PVC FLANGER



Max 16 bar



-20°C til +25°C,
dog ved <4 bar: 60°C



Her er flangerne til PVC fittings.

U-PVC er i bund og grund et af de bedste plast produkter, der anvendes til rør installationer.

U-PVC har mange gode egenskaber. Brandhæmmende, høj mekanisk styrke, god elektrisk isolations evne. Den er modstandsdygtighed over for kemikalier og slid, er smagløs og lugter mindre, som gør den ideel til brug med drikkevand.

Både fittings og rør er lette i vægt og fremstillet glatte, hvilket giver et fremragende flow, som mindsker bundfald og oplagring af snavs.

U-PVC fittings kan anvendes indenfor landbrug, vanding, vandværker, kemiske installationer, vandbehandling og i swimmingpools.

U-PVC overholder gældende normer i Scandinavien, Tyskland, Holland, England, Frankrig og Italien, og kan anvendes sammen med rør fremstillet efter samme international standarder.

Standarder limfittings: ISO 727, DIN 8063, KIWA BRL-K 17301, EN ISO 1452
Standarder gevind fittings: ISO 7/1, DIN 2999, BS 21, UNI ISO 228/1.

Løsflange DIN 8063

U-PVC (POLYVINYLCHLORID)



Varenr.	DN	dim	DKK
AF8063-20	15	20mm	21,15
AF8063-25	20	25mm	22,95
AF8063-32	25	32mm	26,55
AF8063-40	32	40mm	36,90
AF8063-50	40	50mm	41,10
AF8063-63	50	63mm	47,55
AF8063-75	65	75mm	61,70
AF8063-90	80	90mm	73,15
AF8063-110	100	110mm	86,80
AF8063-125	110	125mm	114,25
AF8063-140	125	140mm	130,25
AF8063-160	150	160mm	163,75
AF8063-200	200	200mm	323,75
AF8063-225	200	225mm	346,50
AF8063-250	225	250mm	362,25
AF8063-280	250	280mm	694,00
AF8063-315	300	315mm	771,50

Flangebøsning til lim

U-PVC (POLYVINYLCHLORID)



Varenr.	DN	ø/Ø	Flange ØDKK
AL60-20	15	20/27	34 6,05
AL60-25	20	25/33	41 6,85
AL60-32	25	32/41	50 7,50
AL60-40	32	40/50	61 11,65
AL60-50	40	50/61	73 17,30
AL60-63	50	63/76	90 31,55
AL60-75	65	75/90	106 48,15
AL60-90	80	90/108	125 57,90
AL60-110	100	110/131	150 96,65
AL60-125	110	125/147	167 215,75
AL60-140	125	140/163	187 260,50
AL60-160	150	160/185	213 313,50
AL60-200	200	200/231	253 389,50
AL60-225	200	225/247	274 413,50
AL60-250	225	250/273	307 799,00
AL60-280	250	280/308	329 1272,25
AL60-315	300	315/346	379 1204,25

Pakning

EPDM



Til flangebøsning			
Varenr.	DN	dim	DKK
AL61-20	15	20mm	7,00
AL61-25	20	25mm	7,00
AL61-32	25	32mm	8,25
AL61-40	32	40mm	13,85
AL61-50	40	50mm	16,35
AL61-63	50	63mm	19,20
AL61-75	65	75mm	26,55
AL61-90	80	90mm	26,55
AL61-110	100	110mm	46,50
AL61-125	110	125mm	67,75
AL61-140	125	140mm	80,00
AL61-160	150	160mm	107,50
AL61-200	200	200mm	158,50
AL61-225	200	225mm	183,00
AL61-250	225	250mm	217,00
AL61-280	250	280mm	276,00
AL61-315	300	315mm	358,75

Løsflange sæt DIN 8063

U-PVC (POLYVINYLCHLORID)

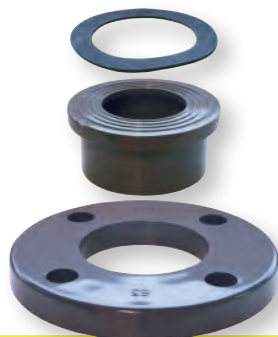

Flange+pakning+bøsning

Varenr.	DN	dim	DKK
SAF8063-20	15	20	33,35
SAF8063-25	20	25	35,75
SAF8063-32	25	32	40,70
SAF8063-40	32	40	60,50
SAF8063-50	40	50	72,50
SAF8063-63	50	63	95,30
SAF8063-75	65	75	132,75
SAF8063-90	80	90	152,00
SAF8063-110	100	110	223,00
SAF8063-125	110	125	385,75
SAF8063-140	125	140	456,50
SAF8063-160	150	160	567,25
SAF8063-200	200	200	845,75
SAF8063-225	200	225	914,75
SAF8063-250	225	250	1408,25
SAF8063-280	250	280	2289,75
SAF8063-315	300	315	2373,25

Flange med krave

U-PVC (POLYVINYLCHLORID)



Varenr.	DN	dim	DKK
AFL2633-20	15	20mm	24,35
AFL2633-25	20	25mm	31,55
AFL2633-32	25	32mm	37,70
AFL2633-40	32	40mm	48,75
AFL2633-50	40	50mm	57,90
AFL2633-63	50	63mm	73,15
AFL2633-75	65	75mm	90,90
AFL2633-90	80	90mm	113,25
AFL2633-110	100	110mm	148,25

Blindflange DIN 8063

U-PVC (POLYVINYLCHLORID)



Varenr.	DN	dim	DKK
AFB8063-20	15	20mm	25,55
AFB8063-25	20	25mm	28,40
AFB8063-32	25	32mm	38,30
AFB8063-40	32	40mm	49,50
AFB8063-50	40	50mm	60,35
AFB8063-63	50	63mm	74,55
AFB8063-75	65	75mm	98,85
AFB8063-90	80	90mm	115,50
AFB8063-110	100	110mm	149,25
AFB8063-125	110	125mm	173,25
AFB8063-140	125	140mm	204,75
AFB8063-160	150	160mm	228,50
AFB8063-200	200	200mm	441,50
AFB8063-225	200	225mm	455,75

Gevindflange med krave

U-PVC (POLYVINYLCHLORID) - BSPP



Varenr.	BSPP	DKK
AFR2633-15	1/2"	40,20
AFR2633-20	3/4"	45,05
AFR2633-25	1"	57,35
AFR2633-32	1 1/4"	82,75
AFR2633-40	1 1/2"	110,00
AFR2633-50	2"	138,50
AFR2633-65	2 1/2"	178,25
AFR2633-80	3"	217,75
AFR2633-100	4"	263,75

PVC GEVINDFITTINGS



Max 16 bar



-20°C til +25°C,
dog ved <4 bar: 60°C



Her er flangerne til PVC fittings.

U-PVC er i bund og grund et af de bedste plast produkter, der anvendes til rør installationer.

U-PVC har mange gode egenskaber. Brandhæmmende, høj mekanisk styrke, god elektrisk isolations evne. Den er modstandsdygtighed over for kemikalier og slid, er smagløs og lugter mindre, som gør den ideel til brug med drikkevand.

Både fittings og rør er lette i vægt og fremstillet glatte, hvilket giver et fremragende flow, som mindsker bundfald og oplagring af snavs.

U-PVC fittings kan anvendes indenfor landbrug, vanding, vandværker, kemiske installationer, vandbehandling og i swimmingpools.

U-PVC overholder gældende normer i Scandinavien, Tyskland, Holland, England, Frankrig og Italien, og kan anvendes sammen med rør fremstillet efter samme international standarder.

Standarder limfittings: ISO 727, DIN 8063, KIWA BRL-K 17301, EN ISO 1452
Standarder gevind fittings: ISO 7/1, DIN 2999, BS 21, UNI ISO 228/1.

PLASTFITTINGS

Vinkel 90° muf/muf

U-PVC (POLYVINYLCHLORID) - BSPP



Varenr.	BSPP	DKK
AR1-3	3/8"	9,25
AR1-4	1/2"	9,25
AR1-5	3/4"	12,20
AR1-6	1"	14,00
AR1-7	1 1/4"	22,55
AR1-8	1 1/2"	33,65
AR1-9	2"	42,20
AR1-10	2 1/2"	118,00
AR1-11	3"	167,75
AR1-12	4"	275,50

T-stk m. gevinder

U-PVC (POLYVINYLCHLORID) - BSPP

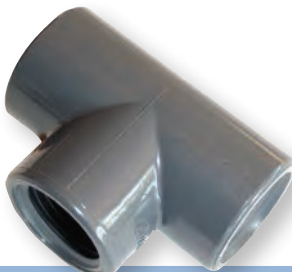

Varenr.	BSPP	DKK
AR2-3	3/8"	11,05
AR2-4	1/2"	11,45
AR2-5	3/4"	15,05
AR2-6	1"	18,80
AR2-7	1 1/4"	26,05
AR2-8	1 1/2"	40,00
AR2-9	2"	58,75
AR2-10	2 1/2"	146,25
AR2-11	3"	189,25
AR2-12	4"	339,50

Vinkel 45° muf/muf

U-PVC (POLYVINYLCHLORID) - BSPP



Varenr.	BSPP	DKK
AR5-3	3/8"	20,05
AR5-4	1/2"	20,75
AR5-5	3/4"	21,95
AR5-6	1"	27,25
AR5-7	1 1/4"	36,20
AR5-8	1 1/2"	48,55
AR5-9	2"	72,10
AR5-10	2 1/2"	180,75
AR5-11	3"	225,50
AR5-12	4"	345,75

Union flad muf/muf

U-PVC / EPDM - BSPP



Varenr.	BSPP	DKK
AR6-3	3/8"	27,65
AR6-4	1/2"	32,85
AR6-5	3/4"	37,00
AR6-6	1"	47,75
AR6-7	1 1/4"	59,25
AR6-8	1 1/2"	80,55
AR6-9	2"	109,75
AR6-10	2 1/2"	306,50
AR6-11	3"	351,50
AR6-12	4"	405,50

Brystnippel reduktion

U-PVC (POLYVINYLCHLORID) - BSPT



Varenr.	BSPT	DKK
AR10-4	1/2" × 3/8"	11,45
AR10-5	3/4" × 1/2"	12,85
AR10-6	1" × 3/4"	16,30
AR10-7	1 1/4" × 1"	20,75
AR10-8	1 1/2" × 1 1/4"	24,75
AR10-9	2" × 1 1/2"	37,25
AR10-10	2 1/2" × 2"	72,10
AR10-11	3" × 2 1/2"	87,65
AR10-12	4" × 3"	136,50

Rørprop sekskant

U-PVC (POLYVINYLCHLORID) - BSPT



Varenr.	BSPT	DKK
AR12-3	3/8"	6,40
AR12-4	1/2"	6,40
AR12-5	3/4"	8,05
AR12-6	1"	9,80
AR12-7	1 1/4"	14,45
AR12-8	1 1/2"	17,25
AR12-9	2"	22,55
AR12-10	2 1/2"	78,90
AR12-11	3"	92,55
AR12-12	4"	159,25

Brystnippel

U-PVC (POLYVINYLCHLORID) - BSPT



Varenr.	BSPT	DKK
AR9-3	3/8"	7,60
AR9-4	1/2"	8,15
AR9-5	3/4"	10,05
AR9-6	1"	11,90
AR9-7	1 1/4"	12,45
AR9-8	1 1/2"	18,20
AR9-9	2"	25,65
AR9-10	2 1/2"	66,10
AR9-11	3"	91,50
AR9-12	4"	141,50

Gevindrør

U-PVC (POLYVINYLCHLORID) - BSPP



Varenr.	BSPP	L	DKK
AR99-4	1/2"	60mm	13,40
AR99-5	3/4"	60mm	27,85
AR99-6	1"	80mm	38,15
AR99-7	1 1/4"	80mm	45,35
AR99-8	1 1/2"	80mm	47,40
AR99-9	2"	100mm	51,50
AR99-10	2 1/2"	120mm	66,95
AR99-11	3"	150mm	88,60
AR99-12	4"	150mm	110,25

Slangenippel

U-PVC (POLYVINYLCHLORID) - BSPT



Varenr.	Ø × BSPT	DKK
AR14-2	12 × 1/4"	5,95
AR14-3	16 × 3/8"	6,40
AR14-4	20 × 1/2"	8,15
AR14-5	25 × 3/4"	9,80
AR14-6	32 × 1"	11,45
AR14-7	40 × 1 1/4"	16,30
AR14-8	50 × 1 1/2"	21,25
AR14-9	60 × 2"	33,40

Kontramøtrik

U-PVC (POLYVINYLCHLORID) - BSPP

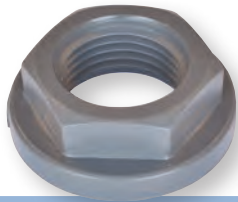

Varenr.	BSPP	DKK
AR15-3	3/8"	7,95
AR15-4	1/2"	9,80
AR15-5	3/4"	11,45
AR15-6	1"	15,05
AR15-7	1 1/4"	21,95
AR15-8	1 1/2"	24,75
AR15-9	2"	36,20
AR15-10	2 1/2"	65,55
AR15-11	3"	90,10
AR15-12	4"	123,00

Muffe m. gevinder

U-PVC (POLYVINYLCHLORID) - BSPP



Varenr.	BSPP	DKK
AR22-3	3/8"	9,45
AR22-4	1/2"	10,05
AR22-5	3/4"	11,45
AR22-6	1"	12,85
AR22-7	1 1/4"	18,20
AR22-8	1 1/2"	26,35
AR22-9	2"	35,05
AR22-10	2 1/2"	101,00
AR22-11	3"	123,75
AR22-12	4"	175,50

Nippelmuffe kort

U-PVC - BSPT×BSPP



Varenr.	BSPT×BSPP	DKK
AR28-5	3/4" × 1/2"	9,25
AR28-6	1" × 3/4"	11,45
AR28-7	1 1/4" × 1"	16,05
AR28-8	1 1/2" × 1 1/4"	20,75
AR28-9	2" × 1 1/2"	27,25
AR28-10	2 1/2" × 2"	66,60
AR28-11	3" × 2 1/2"	92,55
AR28-12	4" × 3"	146,25

Slutmuffe sekant

U-PVC (POLYVINYLCHLORID) - BSPP



Varenr.	BSPP	DKK
AR16-3	3/8"	7,95
AR16-4	1/2"	9,25
AR16-5	3/4"	10,45
AR16-6	1"	11,80
AR16-7	1 1/4"	17,25
AR16-8	1 1/2"	19,45
AR16-9	2"	27,25
AR16-10	2 1/2"	91,50
AR16-11	3"	123,75
AR16-12	4"	155,50

Formmuffe m. gevinder

U-PVC (POLYVINYLCHLORID) - BSPP

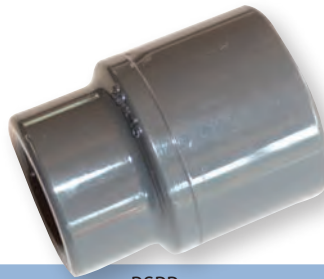

Varenr.	BSPP	DKK
AR18-4	1/2" × 3/8"	17,50
AR18-5	3/4" × 1/2"	18,20
AR18-6	1" × 3/4"	18,80
AR18-7	1 1/4" × 1"	24,15
AR18-8	1 1/2" × 1 1/4"	33,65
AR18-9	2" × 1 1/2"	48,55
AR18-10	2 1/2" × 2"	103,75
AR18-11	3" × 2 1/2"	124,75
AR18-12	4" × 3"	178,00

Spidsmuffe

U-PVC - BSPP×BSPT



Varenr.	BSPP×BSPT	DKK
AR29-4	1/2" × 3/8"	16,05
AR29-5	3/4" × 1/2"	16,60
AR29-6	1" × 3/4"	17,50
AR29-7	1 1/4" × 1"	18,80
AR29-8	1 1/2" × 1 1/4"	39,15
AR29-9	2" × 1 1/2"	28,40
AR29-10	2 1/2" × 2"	63,90
AR29-11	3" × 2 1/2"	78,35
AR29-12	4" × 3"	134,25

Nippelmuffe lang

U-PVC - BSPT×BSPP



Varenr.	BSPT×BSPP	DKK
AR30-4	1/2" × 3/8"	8,40
AR30-5-3	3/4" × 3/8"	8,40
AR30-5	3/4" × 1/2"	8,40
AR30-6-3	1" × 3/8"	11,45
AR30-6-4	1" × 1/2"	11,45
AR30-6	1" × 3/4"	11,45
AR30-7-4	1 1/4" × 1/2"	15,75
AR30-7-5	1 1/4" × 3/4"	15,75
AR30-7	1 1/4" × 1"	15,75
AR30-8-5	1 1/2" × 3/4"	20,75
AR30-8-6	1 1/2" × 1"	20,75
AR30-8	1 1/2" × 1 1/4"	20,75
AR30-9-6	2" × 1"	28,15
AR30-9-7	2" × 1 1/4"	28,15
AR30-9	2" × 1 1/2"	28,15
AR30-10-7	2 1/2" × 1 1/4"	57,35
AR30-10-8	2 1/2" × 1 1/2"	57,35
AR30-10	2 1/2" × 2"	57,35
AR30-11-8	3" × 1 1/2"	86,80
AR30-11-9	3" × 2"	86,80
AR30-11	3" × 2 1/2"	86,80
AR30-12-9	4" × 2"	141,50
AR30-12-10	4" × 2 1/2"	141,50
AR30-12	4" × 3"	141,50

Slangeforskruing flad

U-PVC / EPDM - BSPP



Varenr.	Ø × BSPP	DKK
AR46-16-5	16 × 3/4"	20,05
AR46-20-6	20 × 1"	21,95
AR46-25-7	25 × 1 1/4"	27,55
AR46-30-8	30 × 1 1/2"	36,70
AR46-40-9	40 × 2"	50,75

Tank adapter

U-PVC (POLYVINYLCHLORID) - BSPP



Varenr.	BSPP	DKK
AR98-4	1/2"	55,65
AR98-5	3/4"	61,80
AR98-6	1"	81,40
AR98-7	1 1/4"	111,25
AR98-8	1 1/2"	125,75
AR98-9	2"	157,75
AR98-10	2 1/2"	247,25
AR98-11	3"	331,75
AR98-12	4"	452,25

Skotgennemføring nip/nip

U-PVC (POLYVINYLCHLORID) - BSPP



Varenr.	BSPP	Ø	DKK
ARL98-20-1	3/4"	20	134,25
ARL98-50-1	2" × 2 1/4"	50	244,25
ARL98-63-1	2 1/2"	63	481,50
ARL98-90-1	4" × M113	90	831,50
ARL98-75-1	3"	75	549,25

Bundprop m. slutmuffe

PP (POLYPROPYLEN) - BSPP



Varenr.	BSPP	Ext. dim	DKK
ARL99-8	1 1/2"	49	140,25

Skueglas muf/muf

U-PVC (POLYVINYLCHLORID) - BSPP



Varenr.	BSPP	DN	DKK
AH16-10	2 1/2"	100	2079,75
AH16-11	3"	100	2246,50
AH16-12	4"	100	2519,50

PVC LIM & GEVINDFITTINGS



Max 16 bar



-20°C til +25°C, dog ved <4 bar: 60°C



Her er flangerne til PVC fittings.

U-PVC er i bund og grund et af de bedste plast produkter, der anvendes til rør installationer.

U-PVC har mange gode egenskaber. Brandhæmmende, høj mekanisk styrke, god elektrisk isolations evne. Den er modstandsdygtighed over for kemikalier og slid, er smagløs og lugter mindre, som gør den ideel til brug med drikkevand.

Både fittings og rør er lette i vægt og fremstillet glatte, hvilket giver et fremragende flow, som mindsker bundfald og oplagring af snavs.

U-PVC fittings kan anvendes indenfor landbrug, vanding, vandværker, kemiske installationer, vandbehandling og i swimmingpools.

U-PVC overholder gældende normer i Scandinavien, Tyskland, Holland, England, Frankrig og Italien, og kan anvendes sammen med rør fremstillet efter samme international standarder.

Standarder limfittings: ISO 727, DIN 8063, KIWA BRL-K 17301, EN ISO 1452
Standarder gevind fittings: ISO 7/1, DIN 2999, BS 21, UNI ISO 228/1.

PLASTFITTINGS

Vinkel 90° lim/muffe

U-PVC (POLYVINYLCHLORID) - BSPP



Varenr.	Indv. x BSPP	Udv.	DKK
ARL1-16-3	16 x 3/8"	23,5	9,25
ARL1-20-4	20 x 1/2"	26,5	17,50
ARL1-25-5	25 x 3/4"	32,5	13,55
ARL1-32-6	32 x 1"	41	17,25
ARL1-40-7	40 x 1 1/4"	50	30,35
ARL1-50-8	50 x 1 1/2"	60	41,45
ARL1-63-9	63 x 2"	75	57,60
ARL1-75-10	75 x 2 1/2"	89	145,00
ARL1-90-11	90 x 3"	106	179,25
ARL1-110-12	110 x 4"	129	275,50

Vinkel 90° lim/muffe

U-PVC (POLYVINYLCHLORID) - BSPP



Med forstærkningsring

Varenr.	Indv. x BSPP	Udv.	DKK
ARL1-20-4F	20 x 1/2"	26,5	17,50
ARL1-25-5F	25 x 3/4"	32,5	18,80
ARL1-32-6F	32 x 1"	41	25,65
ARL1-40-7F	40 x 1 1/4"	50	36,20
ARL1-50-8F	50 x 1 1/2"	60	51,90
ARL1-63-9F	63 x 2"	75	78,90

Skotgennemføring lim/nip

U-PVC (POLYVINYLCHLORID) - BSPP



Varenr.	Indv. x BSPP	Udv.	DKK
ARL98-20	20 x 3/4"	25	134,25
ARL98-25	25 x 1"	32	165,25
ARL98-32	32 x 1 1/4"	40	186,50
ARL98-40	40 x 1 3/4"	50	216,00
ARL98-50	50 x 2"	63	244,25
ARL98-63	63 x 2 1/2"	75	481,50

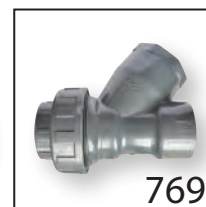
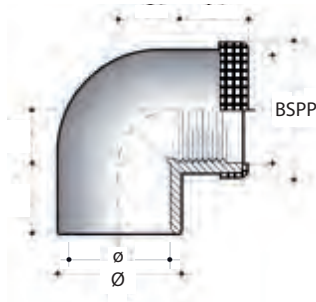
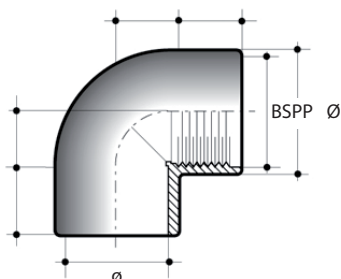

769

769

T-stk lim/muffe/lim

U-PVC (POLYVINYLCHLORID) - BSPP



Varenr.	Indv.	Udv.	DKK
ARL2-16-3	16×3/8"×16	23,5	11,45
ARL2-20-4	20×1/2"×20	27,5	12,85
ARL2-25-5	25×3/4"×25	33,5	15,75
ARL2-32-6	32×1"×32	42	20,75
ARL2-40-7	40×1¼"×40	51	28,40
ARL2-50-8	50×1½"×50	61	42,20
ARL2-63-9	63×2"×63	75	69,90
ARL2-75-10	75×2½"×75	89	133,00
ARL2-90-11	90×3"×90	106	191,25
ARL2-110-12	110×4"×110	129	315,00

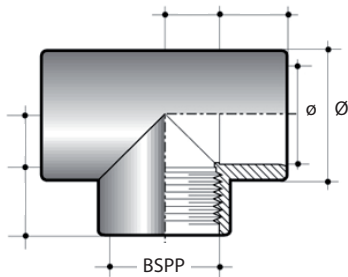

T-stk lim/muffe/lim

U-PVC (POLYVINYLCHLORID)



Med forstærkningsring			
Varenr.	Indv.	Udv.	DKK
ARL2-20-4F	20×1/2"×20	27,5	19,45
ARL2-25-5F	25×3/4"×25	33,5	24,50
ARL2-32-6F	32×1"×32	42	28,95
ARL2-40-7F	40×1¼"×40	51	42,75
ARL2-50-8F	50×1½"×50	61	60,05
ARL2-63-9F	63×2"×63	75	84,10

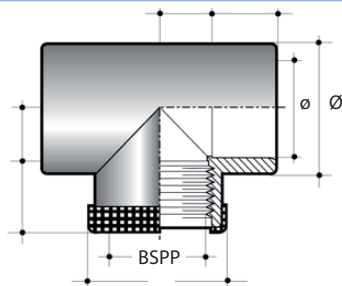

Vinkel 45° lim/muffe

U-PVC (POLYVINYLCHLORID) - BSPP



Varenr.	Indv. × BSPP	Udv.	DKK
ARL5-16-3	16 × 3/8"	23,5	15,75
ARL5-20-4	20 × 1/2"	28	16,30
ARL5-25-5	25 × 3/4"	34	17,90
ARL5-32-6	32 × 1"	42	21,95
ARL5-40-7	40 × 1¼"	51	30,35
ARL5-50-8	50 × 1½"	61	38,10
ARL5-63-9	63 × 2"	75	56,85
ARL5-75-10	75 × 2½"	89	120,75
ARL5-90-11	90 × 3"	106	155,50
ARL5-110-12	110 × 4"	128	277,00

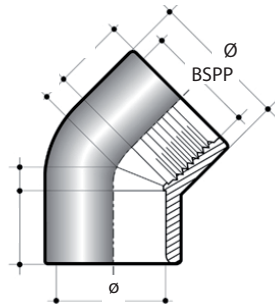

Union flad lim/muffe

U-PVC / EPDM - BSPP



Varenr.	Indv. × BSPP	NT	DKK
ARL6-16-3	16 × 3/8"	3/4"	27,90
ARL6-20-4	20 × 1/2"	1"	34,75
ARL6-25-5	25 × 3/4"	1¼"	39,40
ARL6-32-6	32 × 1"	1½"	52,15
ARL6-40-7	40 × 1¼"	2"	60,65
ARL6-50-8	50 × 1½"	2¼"	85,70
ARL6-63-9	63 × 2"	2¾"	112,75
ARL6-75-10	75 × 2½"	3½"	271,50
ARL6-90-11	90 × 3"	4"	311,50
ARL6-110-12	110 × 4"	5"	365,25

NT = omløbergevind

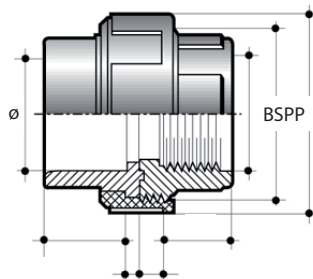

Union flad lim/muf

U-PVC / GALVANISERET - BSPP



Varenr.	Indv. × BSPP	DKK
AL340-3	16 × 3/8"	148,25
AL340-4	20 × 1/2"	155,75
AL340-5	25 × 3/4"	177,00
AL340-6	32 × 1"	200,25
AL340-7	40 × 1¼"	264,50
AL340-8	50 × 1½"	360,00
AL340-9	63 × 2"	544,50

Med gummipakning

Union flad lim/nippel

U-PVC / EPDM - BSPT



Varenr.	Indv. × BSPT	DKK
ARL8-50-8	50 × 1½"	54,35
ARL8-50-9	50 × 2"	54,35
ARL8-63-9	63 × 2"	75,65

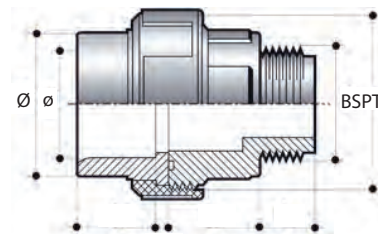

Union flad lim/nip

U-PVC / GALVANISERET - BSPP



Varenr.	Indv. × BSPT	DKK
AL341-4	20 × 1/2"	178,75
AL341-5	25 × 3/4"	210,25
AL341-6	32 × 1"	241,75
AL341-7	40 × 1¼"	419,50
AL341-8	50 × 1½"	436,25
AL341-9	63 × 2"	637,50

Med gummipakning

Muffe lim/gevind
U-PVC (POLYVINYLCHLORID) - BSPP

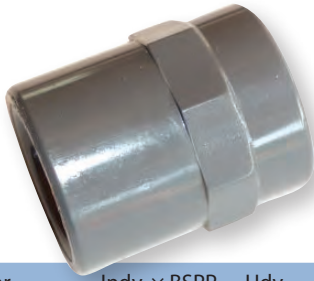

Varenr.	Indv. x BSPP	Udv.	DKK
ARL22-16-3	16 x 3/8"	23,5	9,80
ARL22-20-4	20 x 1/2"	28	10,45
ARL22-25-5	25 x 3/4"	34	11,05
ARL22-32-6	32 x 1"	42	12,85
ARL22-40-7	40 x 1 1/4"	50,5	18,20
ARL22-50-8	50 x 1 1/2"	61	27,90
ARL22-63-9	63 x 2"	75	36,20
ARL22-75-10	75 x 2 1/2"	89	109,25
ARL22-90-11	90 x 3"	106	123,75
ARL22-110-12	110 x 4"	129	179,25
ARL22-125-13	125 x 5"	145	243,00

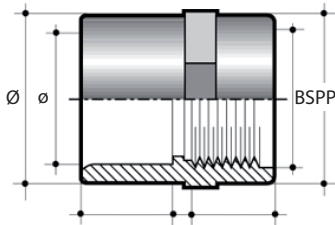

Nippelmuffe lim/gevind
U-PVC (POLYVINYLCHLORID) - BSPP

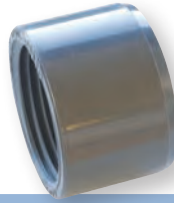

Varenr.	Udv. x BSPP	DKK
ARL31-25-4	25 x 1/2"	11,05
ARL31-32-5	32 x 3/4"	12,85
ARL31-40-6	40 x 1"	20,05
ARL31-50-7	50 x 1 1/4"	25,35
ARL31-63-8	63 x 1 1/2"	33,10
ARL31-75-9	72 x 2"	75,90
ARL31-90-10	90 x 2 1/2"	105,50
ARL31-110-11	110 x 3"	168,75

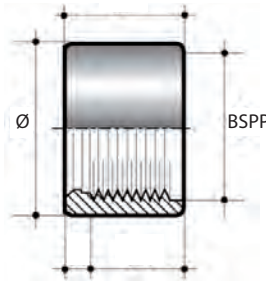

Spidsmuffe lim/gevind
U-PVC (POLYVINYLCHLORID) - BSPP



Varenr.	Udv. x BSPP	DKK
ARL29-16-3	16 x 3/8"	14,00
ARL29-16-4	16 x 1/2"	14,45
ARL29-20-4	20 x 1/2"	15,75
ARL29-20-5	20 x 3/4"	17,50
ARL29-25-4	25 x 1/2"	18,20
ARL29-25-5	25 x 3/4"	18,20
ARL29-25-6	25 x 1"	18,20
ARL29-32-5	32 x 3/4"	18,80
ARL29-32-6	32 x 1"	21,25
ARL29-40-6	40 x 1"	22,55
ARL29-40-7	40 x 1 1/4"	26,05
ARL29-50-7	50 x 1 1/4"	28,70
ARL29-50-8	50 x 1 1/2"	30,35
ARL29-50-9	50 x 2"	40,85
ARL29-63-8	63 x 1 1/2"	54,35
ARL29-63-9	63 x 2"	54,35
ARL29-75-9	75 x 2"	65,55
ARL29-75-10	75 x 2 1/2"	69,90
ARL29-75-11	75 x 3"	71,25
ARL29-90-10	90 x 2 1/2"	96,95
ARL29-90-11	90 x 3"	100,50
ARL29-90-12	90 x 4"	103,75
ARL29-110-11	110 x 3"	130,75
ARL29-110-12	110 x 4"	135,50

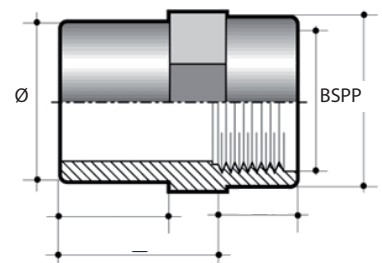

Muffe lim/gevind
U-PVC (POLYVINYLCHLORID) - BSPP



Med forstærkningsring

Varenr.	Indv. x BSPP	Udv.	DKK
ARL22-20-4F	20 x 1/2"	28	17,25
ARL22-25-5F	25 x 3/4"	34	18,80
ARL22-32-6F	32 x 1"	42	21,95
ARL22-40-7F	40 x 1 1/4"	50,5	27,25
ARL22-50-8F	50 x 1 1/2"	61	36,20
ARL22-63-9F	63 x 2"	75	43,60

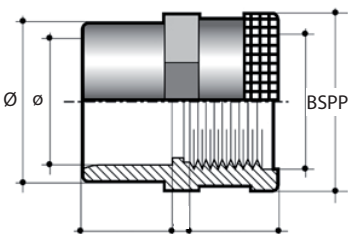

Spidsmuffe lim/gevind

U-PVC (POLYVINYLCHLORID) - BSPP



Med forstærkningsring

Varenr.	Udv. x BSPP	DKK
ARL29-20-4F	20 x 1/2"	15,75
ARL29-20-5F	20 x 3/4"	17,25
ARL29-25-4F	25 x 1/2"	18,20
ARL29-25-5F	25 x 3/4"	18,80
ARL29-25-6F	25 x 1"	20,05
ARL29-32-5F	32 x 3/4"	20,75
ARL29-32-6F	32 x 1"	22,55
ARL29-40-6F	40 x 1"	23,75
ARL29-40-7F	40 x 1 1/4"	25,65
ARL29-50-7F	50 x 1 1/4"	28,40
ARL29-50-8F	50 x 1 1/2"	27,65
ARL29-50-9F	50 x 2"	40,00
ARL29-63-8F	63 x 1 1/2"	52,15
ARL29-63-9F	63 x 2"	54,35

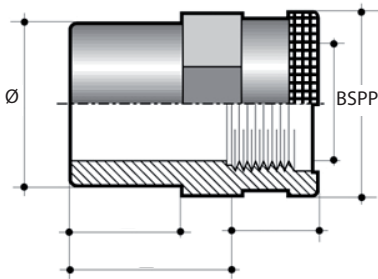

Spidsmuffe lim/gevind

U-PVC (POLYVINYLCHLORID) - BSPT



Varenr.	Indv. x BSPT	Udv.	DKK
ARL30-12-16-3	12 x 3/8"	16	7,05
ARL30-16-20-3	16 x 3/8"	20	7,60
ARL30-16-20-4	16 x 1/2"	20	7,60
ARL30-20-25-3	20 x 3/8"	25	8,50
ARL30-20-25-4	20 x 1/2"	25	8,50
ARL30-20-25-5	20 x 3/4"	25	8,50
ARL30-25-32-4	25 x 1/2"	32	9,25
ARL30-25-32-5	25 x 3/4"	32	9,25
ARL30-25-32-6	25 x 1"	32	9,25
ARL30-32-40-5	32 x 3/4"	40	11,45
ARL30-32-40-6	32 x 1"	40	11,45
ARL30-32-40-7	32 x 1 1/4"	40	11,45
ARL30-40-50-6	40 x 1"	50	16,05
ARL30-40-50-7	40 x 1 1/4"	50	16,05
ARL30-40-50-8	40 x 1 1/2"	50	16,05
ARL30-50-63-7	50 x 1 1/4"	63	24,15
ARL30-50-63-8	50 x 1 1/2"	63	24,15
ARL30-50-63-9	50 x 2"	63	24,15
ARL30-63-75-8	63 x 1 1/2"	75	28,40
ARL30-63-75-9	63 x 2"	75	28,40
ARL30-63-75-10	63 x 2 1/2"	75	28,40
ARL30-75-90-9	75 x 2"	90	85,45
ARL30-75-90-10	75 x 2 1/2"	90	85,45
ARL30-75-90-11	75 x 3"	90	85,45
ARL30-90-110-10	90 x 2 1/2"	110	103,00
ARL30-90-110-11	90 x 3"	110	103,00
ARL30-90-110-12	90 x 4"	110	103,00
ARL30-110-125-11	110 x 3"	125	155,50
ARL30-110-125-12	110 x 4"	125	155,50
ARL30-110-125-13	110 x 5"	125	155,50

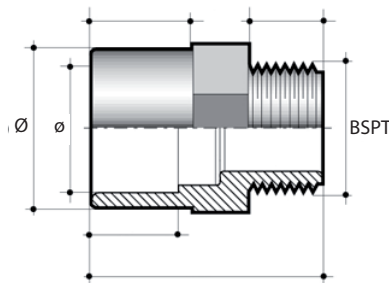

Lim (Gymcol)



Tolerance: 0,2 - 0,8mm mellemrum
Godkendt til drikkevandssystemer.
1 time tørring pr. bar ved +15°C.

Varenr.	Vol.	DKK
AL50-1	125 ml	50,30
AL50-2	250 ml	117,00
AL50-3	500 ml	259,00
AL50-4	1000 ml	304,00

Rengøringsvæske (Gymcol)



Godkendt til drikkevandssystemer

Varenr.	Vol.	DKK
AL51-2	250 ml	73,70
AL51-3	500 ml	152,00
AL51-4	1000 ml	151,50

Lim (Unitec)



Varenr.	Vol.	DKK
AL52-2	125 g	210,00
AL52-3-570	570 g	477,00

ELEKTROSVEJS FITTINGS PE



2,5 til 20bar



-10°C til +50°C



EN1555, EN12201,
DIN16963, TS6270, TS418,
ISO9001



PE er det mest udbredte rørsystem til fremførelse af vand og gas og afledning af spildevand. Denne serie er i PE100.

Elektrosvejssemuffer har indlagte tråde, der opvarmes vha. et elektrosvejsapparat og giver perfekt sammensmeltede samlinger af rør og stuk-el fittings, hvis emnerne er ordentlig skrabet og rengjort

først. Svejseapparatet tager elektronisk højde for alle parametre, der påvirker svejsningen og hver muffe har indikatorer, der viser om svejsningen gik ok.

PLASTFITTINGS



EL muffe PN16 PE (POLYETHYLEN)



Varenr.	ø × Ø	L	DKK
PA25-25	25 × 41	71mm	14,65 α
PA25-32	32 × 48	82mm	14,90 α
PA25-40	40 × 55	86mm	15,50 α
PA25-50	50 × 67	98mm	22,60 α
PA25-63	63 × 80	107mm	23,55 α
PA25-200	200 × 250	220mm	169,75 α
PA25-250	250 × 310	210mm	393,25 α
PA25-315	315 × 390	230mm	553,50 α

α = så længe lager haves

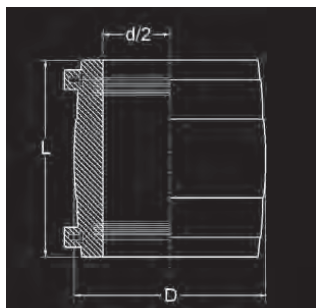

EL Formmuffe PN16 PE (POLYETHYLEN)



Varenr.	ø × ø	L	DKK
PA29-4032	40 × 32	117mm	37,05 α
PA29-6332	63 × 32	142mm	52,50 α
PA29-6350	63 × 50	152mm	53,65 α
PA29-9050	90 × 50	190mm	83,40 α
PA29-9063	90 × 63	190mm	83,40 α
PA29-11063	110 × 63	209mm	123,75 α

α = så længe lager haves

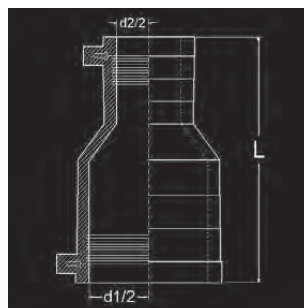

EL vinkel 45° PN16 PE (POLYETHYLEN)



Varenr.	ø	L	DKK
PA28-32	32	116mm	39,60 α
PA28-40	40	139mm	48,55 α
PA28-50	50	166mm	63,70 α
PA28-90	90	242mm	123,75 α
PA28-110	110	268mm	153,75 α

α = så længe lager haves

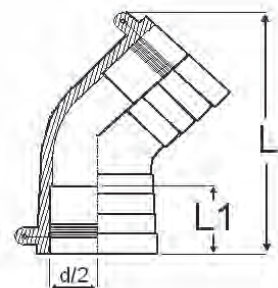

EL T-stk PN16 PE (POLYETHYLEN)

PE (POLYETHYLEN)



Varenr.	ø × Ø × ø	L	X	DKK
PA30-25	25	108mm	37mm	37,75 α
PA30-32	32	128mm	41mm	38,20 α
PA30-40	40	147mm	49mm	53,20 α
PA30-50	50	162mm	49mm	69,60 α
PA30-63	63	186mm	61mm	81,65 α
PA30-75	75	220mm	63mm	109,00 α
PA30-90	90	255mm	74mm	128,50 α
PA30-110	110	257mm	79mm	213,00 α
PA30-160	160	340mm	110mm	501,50 α

α = så længe lager haves, X = gren L

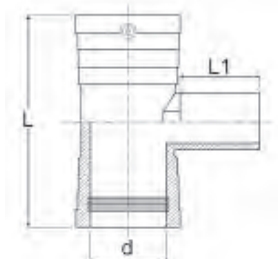

EL muffe PN10 PE (POLYETHYLEN)

PE (POLYETHYLEN)



Varenr.	ø × Ø	L	DKK
PA26-140	140 × 160	171mm	99,85 α
PA26-160	160 × 183	185mm	133,25 α

α = så længe lager haves

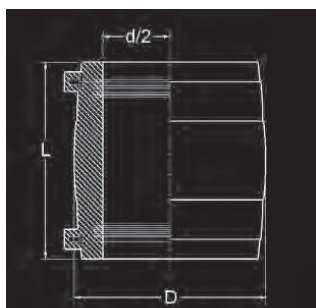

EL vinkel 90° PN16 PE (POLYETHYLEN)

PE (POLYETHYLEN)



Varenr.	ø	L	DKK
PA27-160	160	200mm	396,75 α

α = så længe lager haves

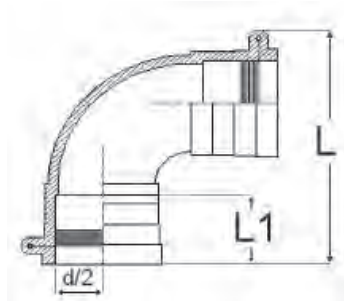

EL slutmuffe PN16

PE (POLYETHYLEN)



Varenr.	ø × Ø	L	DKK
PA31-32	32 × 48	89mm	28,30 α
PA31-40	40 × 55	97mm	32,20 α
PA31-75	75 × 97	145mm	82,80 α
PA31-160	160 × 204	210mm	255,50 α
PA31-200	200 × 247	224mm	345,50 α

α = så længe lager haves

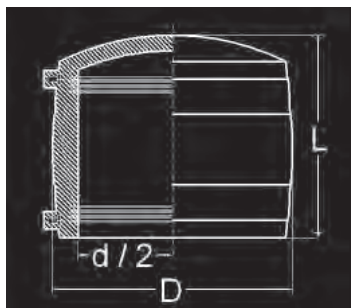

EL muffe/nippel PN16

PE (POLYETHYLEN) - BSPT



Varenr.	ø × dim	L	L1/L2	DKK
PA36-20-4	20 × 1/2"	134	98/64	61,20 α
PA36-25-5	25 × 3/4"	138	102/68	70,00 α
PA36-32-6	32 × 1"	144	108/74	76,10 α
PA36-40-7	40 × 1 1/4"	165	122/81	105,75 α

α = så længe lager haves

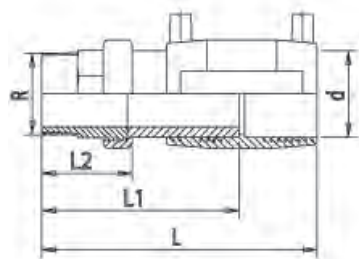

EL anboringsbøjle PN16

PE (POLYETHYLEN)



Med fræser og sideudløb

Varenr.	ø × Ø × ø	H/H1	DKK
PA39-4032	40 × 32 × 40	78/30	113,25 α
PA39-5032	50 × 32 × 50	-/-	123,50 α
PA39-6332	63 × 32 × 63	128/63	134,75 α
PA39-7532	75 × 32 × 75	129/63	159,75 α
PA39-9032	90 × 32 × 90	227/212	145,00 α
PA39-9063	90 × 63 × 90	227/212	157,75 α
PA39-11032	110 × 32 × 110	168/85	159,50 α
PA39-11063	110 × 63 × 110	230/115	172,25 α
PA39-16032	160 × 32 × 160	185/105	252,50 α
PA39-16063	160 × 63 × 160	225/109	269,50 α
PA39-20032	200 × 32 × 200	205/91	315,25 α
PA39-20063	200 × 63 × 200	205/91	365,00 α
PA39-25032	250 × 32 × 250	205/91	468,25 α
PA39-25063	250 × 63 × 250	334/150	479,75 α

α = så længe lager haves

EL anboringsbøjle PN16

PE (POLYETHYLEN)



EL muffe/BSPP PN16

PE (POLYETHYLEN)



Varenr.	ø × dim	L	L1/L2	DKK
PA35-20-4	20 × 1/2"	120	84/50	67,10 α
PA35-25-5	25 × 3/4"	120	84/50	78,90 α
PA35-32-6	32 × 1"	126	90/56	86,50 α
PA35-40-7	40 × 1 1/4"	143	100/59	102,75 α
PA35-50-8	50 × 1 1/2"	153	108/66	132,50 α

α = så længe lager haves

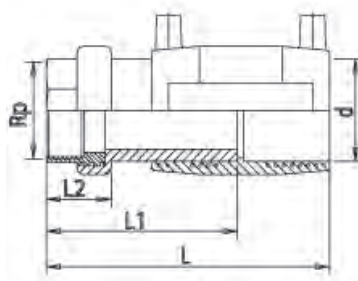

Varenr.	ø × Ø × ø	H	DKK
PA38-9032	90 × 32 × 90	110	124,00 α
PA38-11032	110 × 32 × 110	120	132,50 α
PA38-16032	160 × 32 × 160	145	216,00 α
PA38-16063	160 × 63 × 160	140	216,00 α
PA38-20032	200 × 32 × 200	165	287,50 α
PA38-20063	200 × 63 × 200	160	287,50 α
PA38-25032	250 × 32 × 250	190	461,00 α
PA38-25063	250 × 63 × 250	-	472,75 α

α = så længe lager haves

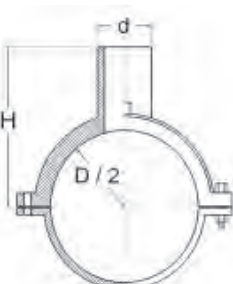

ARBEJDSBESKRIVELSE ELEKTROMUFFESVEJSNING

SVEJSEFORBEREDELSE:

- Røret skæres over i en ret vinkel med et egnet værktøj (rørskærer eller sav).
- Marker indstiktsdybden på røret med en tusch (B1).
- Overfladen på rør-enden skræbes med en skraber på det stykke, der skal ind i elsvemuffen (B2) og selve rør-enden afgrates.
- De bearbejdede overflader rengøres med PE rens og med en fnugfri klud. Rene overflader er vitale for en god svejsning.

NB! Skrabning og rengøring skal ske umiddelbart før svejsningen.

- Elektromuffen pakkes først ud umiddelbart inden svejsningen.
- Rengør muffen med PE rens, og undgå at røre den indvendige del af muffen og de rengjorte rør-ender med fingrene.
- Skyd de 2 rør-ender ind i muffen og fastgør opsætningen i en fikseringsklemme (B3). Rørets afvigelse fra fuldendt rund må max. udgøre 1,5%. Ellers skal man rette op på afvigelsen vha. klemtang.
- Anbring nu kablerne fra svejsmaskinen på muffen (B4). Der må ikke være træk på kablerne.

SVEJSNINGEN:

- De 2 rør-ender sættes sammen i muffen, hvorefter glødetrådene opvarmer PE materialet, så det smelter sammen.
- Ved svejsning aflæses stregkoden med en stregkodepen (B5), eller man kan indtaste volt og tid på maskinen for at svejse manuelt.
- Svejsforløbet styres nu af svejsmaskinen, som efter endt svejsning aktiverer svejseindikatorerne, så de bliver synlige (B6).

NB! Indikatoren siger ikke noget om kvaliteten på svejsningen.

KØLETIDEN:

Det er meget vigtigt at overholde køletiden efter svejsningen. Køletiden vil stå på svejsmaskinen og må ikke forkortes med hurtig temperatursænkning (vand, kold luft, etc). Det svejste rør og muffen må først fjernes fra fikseringsklemmen, når køletiden er overstået.

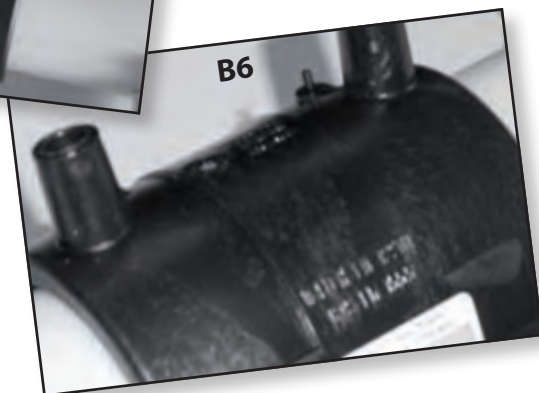
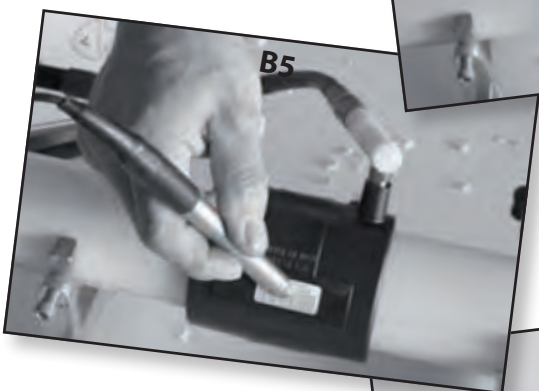
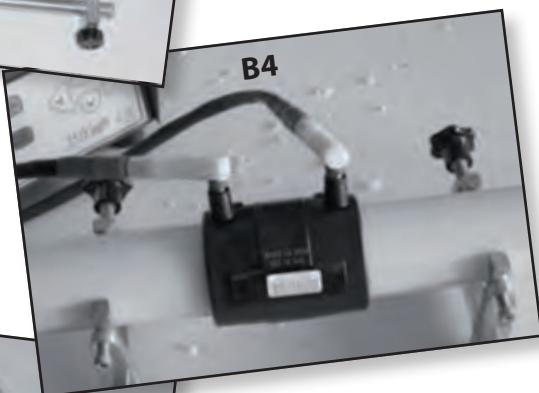
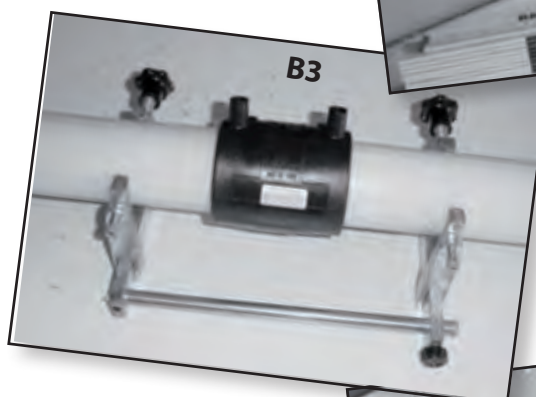
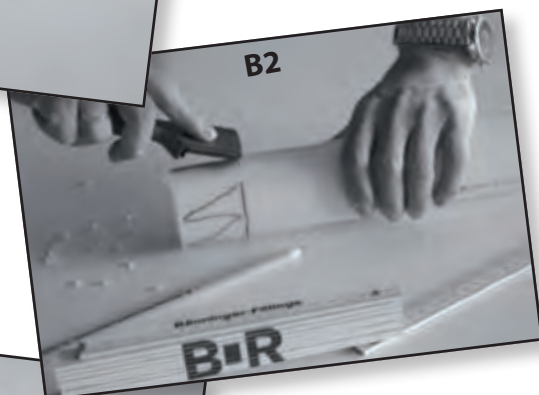
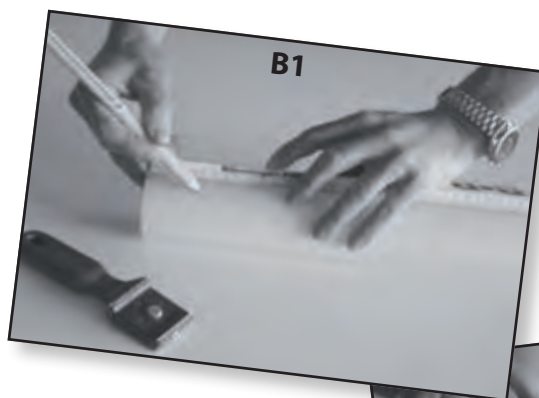

STUK-EL FITTINGS



2,5 til 20bar



EN1555, EN12201,
DIN16963, TS6270, TS418,
ISO9001



Denne type fittings er universelle, i og med at de både kan bruges sammen med elektrosvøjsefittings (hvorfor enderne er rigeligt lange) eller kortes lidt af og svejses sammen med svejsespejl, som stuk fittings.

PLASTFITTINGS

Vinkel 90° nip/nip PN10 PE (POLYETHYLEN)



Varenr.	Ø	l	Z	DKK
PA45-75	75	72	116	47,15 α

α = så længe lager haves

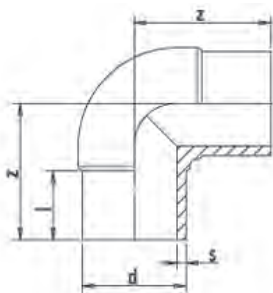

T-stk m. nipler PN10 PE (POLYETHYLEN)



Varenr.	Ø	l	Z	DKK
PA49-110	110	95	168	111,75 α

α = så længe lager haves

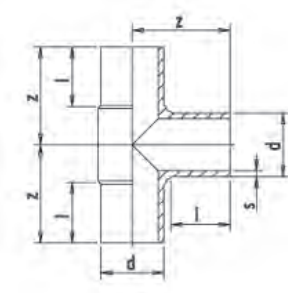

T-stk m. nipler PN16 PE (POLYETHYLEN)



Varenr.	Ø	l	Z	DKK
PA50-32	32	51	75	16,65 α

α = så længe lager haves

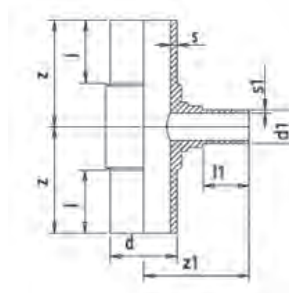

Nippel reduktion PN16

PE (POLYETHYLEN)



75 %
DISCOUNT

Varenr.	Ø × Ø	I/I1	Z	DKK
PA54-7550	75 × 50	63/47	140	32,60 ₺
PA54-9075	90 × 75	79/71	176	44,40 ₺

₺ = så længe lager haves

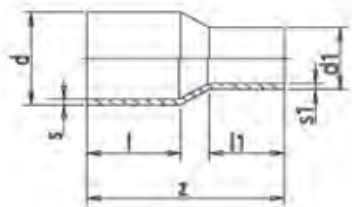

Flangebøsning PN10

PE (POLYETHYLEN)



75 %
DISCOUNT

Varenr.	Ø	D4/D	I/H/Z	DKK
PA57-63	63	75/102	66/14/120	21,80 ₺
PA57-75	75	89/122	78/16/130	27,65 ₺

₺ = så længe lager haves

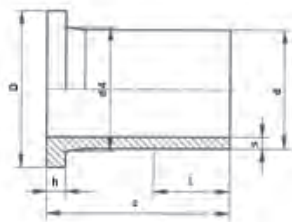

Skueglas til PE svejs

PE (POLYETHYLEN)



75 %
DISCOUNT

Varenr.	Ø	DN	DKK
AH17-1	50mm	50	248,50 ₺
AH17-2	63mm	50	248,50 ₺
AH17-3	90mm	100	760,00 ₺
AH17-4	110mm	100	838,75 ₺
AH17-5	125mm	100	972,00 ₺

₺ = så længe lager haves

Flange PN10

PP (POLYPROPYLEN) / KERNE = STÅL



75 %
DISCOUNT

Varenr.	dim/DN	D/K/B	C/I/BL	DKK
PA65-25	25/20	105/75/14	34/14/4	23,00 ₺
PA65-50	50/40	150/110/18	62/18/4	45,85 ₺
PA65-110	110/100	220/180/18	128/18/8	98,25 ₺
PA65-140	140/125	250/210/24	158/18/8	132,50 ₺
PA65-160	160/150	285/240/24	178/18/8	162,50 ₺
PA65-180	180/150	285/240/24	188/22/8	162,50 ₺

₺ = så længe lager haves

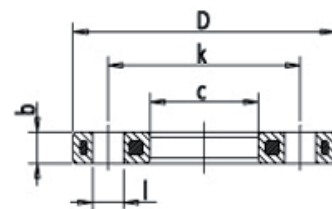

Prop PN10

PE (POLYETHYLEN)



75 %
DISCOUNT

Varenr.	Ø	L	I	DKK
PA55-110	110	105	80	83,70 ₺

₺ = så længe lager haves

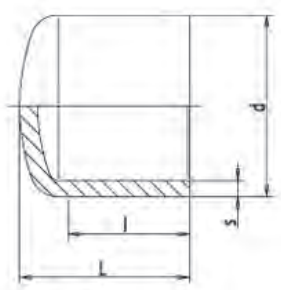

Union indlægsdel PN16

PE (POLYETHYLEN)



75 %
DISCOUNT

Varenr.	Ø	D4/I	L/H	DKK
PA60-75	75	96/94	128/18	36,65 ₺
PA60-90	90	109/103	142/18	49,40 ₺
PA60-110	110	133/110	153/18	61,20 ₺

₺ = så længe lager haves

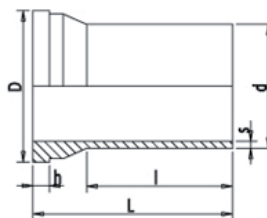

PE cleaner



Varenr.	Vol.	DKK
PA90-1000	1 liter	46,20

STUK FITTINGS

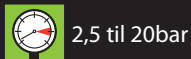

EN1555, EN12201,
DIN16963, TS6270, TS418,
ISO9001



Denne type fittings har for korte ender til at blive brugt med elektrosvøjefittings, så de kan kun svejses sammen vha. et svejsespejl. Spejlet opvarmer enderne på de 2 emner, der skal forbindes, hvorefter spejlet fjernes og enderne presses sammen. Det hele sker i en opstilling, der sikrer korrekt vinkling og pres.

PLASTFITTINGS

Bøjning 90° PN10 PE (POLYETHYLEN)



Varenr.	Ø	l	Z	DKK
PA70-90	90	15	100	35,45 α

α = så længe lager haves

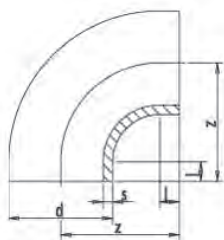

T-stk PN10 PE (POLYETHYLEN)



Varenr.	Ø	l	Z	DKK
PA74-90	90	30	100	58,75 α

α = så længe lager haves



Flangebøsning PN16 PE (POLYETHYLEN)



Varenr.	Ø	D1/d4	H/Z/l	DKK
PA81-90	90	138/105	17/90/29	23,15 α

α = så længe lager haves

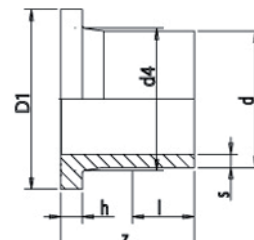

Vinkel 45° PN10 PE (POLYETHYLEN)



Varenr.	Ø	l	Z	DKK
PA72-90	90	15	68	38,20 α

α = så længe lager haves

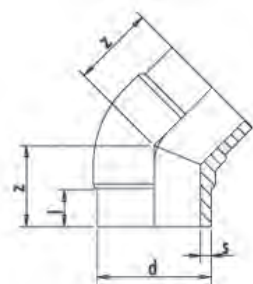

Nippel reduktion PN10 PE (POLYETHYLEN)

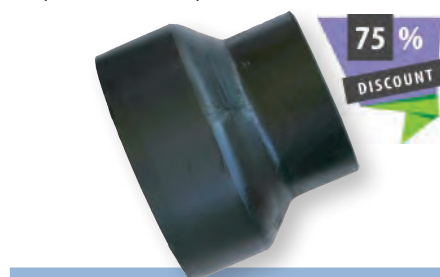

Varenr.	Ø × Ø	l/l1	Z	DKK
PA78-180110	180 × 110	130/40	60	73,05 α

α = så længe lager haves

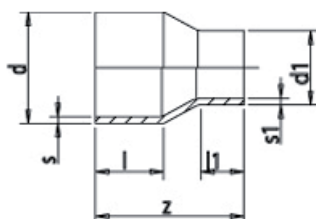

Flange PN10

PP (POLYPROPYLEN) / KERNE = STÅL



Varenr.	dim/DN	D/K/B	C/I/BL	DKK
PA65-25	25/20	105/75/14	34/14/4	23,00 ₺
PA65-50	50/40	150/110/18	62/18/4	45,85 ₺
PA65-110	110/100	220/180/18	128/18/8	98,25 ₺
PA65-140	140/125	250/210/24	158/18/8	132,50 ₺
PA65-160	160/150	285/240/24	178/18/8	162,50 ₺
PA65-180	180/150	285/240/24	188/22/8	162,50 ₺

₺ = så længe lager haves

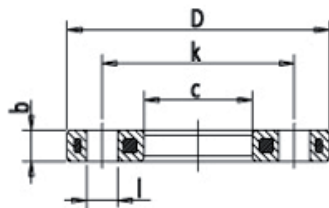

PE cleaner



Varenr.	Vol.	DKK
PA90-1000	1 liter	46,20

ARBEJDSBESKRIVELSE - STUKSVEJSNING

Stuksvejsmaskinen er beregnet til samling af PE rør og PE stukfittings.

Svejsforberedelse:

Svejsespejlet opvarmes til 210°C.

Svejsespejlets temperatur måles, inden der foretages svejsning. Temperatur differens +/- 10 grader.

Svejsespejlet skal være rent og aftørres umiddelbart inden svejsning.

2+3 Rør og fittings monteres nøjagtigt over for hinanden i svejsmaskinen.

4+5 Høvlen placeres i maskinen og rørenderne høvles lige.

Svejsningen:

6 Svejsespejlet monteres i holderen på svejsmaskinen.

7 Rørenderne presses imod spejlet med kompressor med det foreskrevne tryk.

8 Når den anbefalede vulsthøjde er opnået, sænkes trykket til 1/10 bar.

9 Efter endt svejsning åbnes maskinen og varmespejlet fjernes. Maskinen køres sammen.

10 Sammensvejsningen skal påbegyndes umiddelbart efter at svejsespejlet er fjernet og det anbefalede tryk for den givne rørdimension skal overholdes. Afkølingen skal foregå under tryk iflg. vejledningen.

11 Det sammensvejste fjernes fra maskinen efter endt køletid.

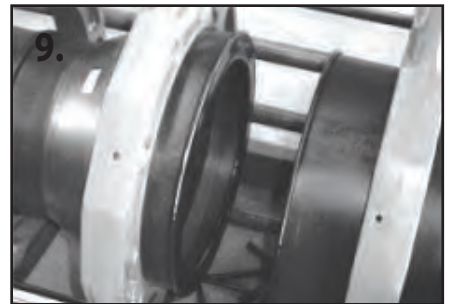
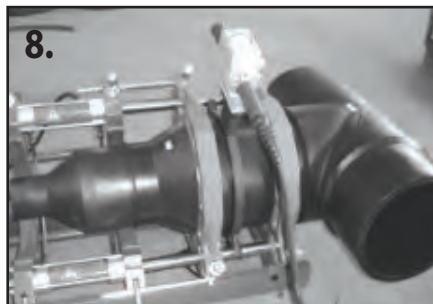
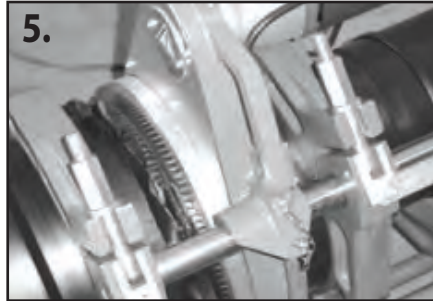
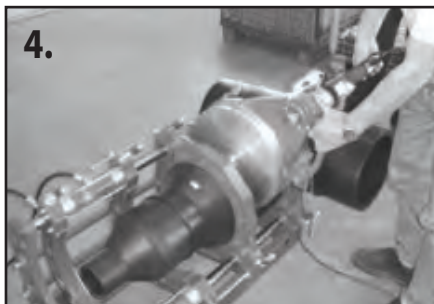
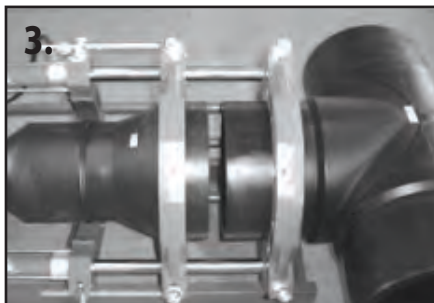
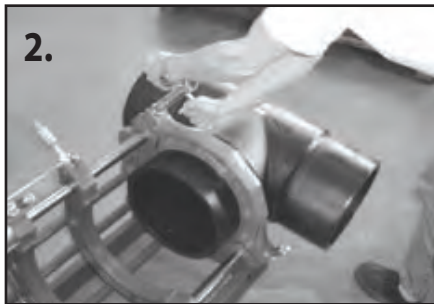
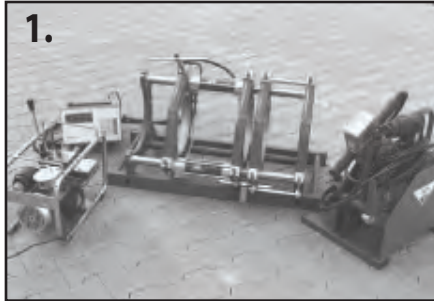

PNEUMATIK & LUFTBEHANDLING



242 PUSH-IN FITTINGS
PLAST/MESSING



259 PUSH-IN FITTINGS
PLAST/MESSING MINI



261 DRØVLEVENTILER
TIL PUSH-IN



264 VENTILER
TIL PUSH-IN



266 KONTRAVENTILER



268 STOPVENTILER



269 PUSH-IN FITTINGS
MESSING



274 PUSH-ON FITTINGS
MESSING



279 GEVINDFITTINGS
MESSING TIL PNEUMATIK



288 LYDDÆMPERE



296 CYLINDRE



300 CYLINDRE RUSTFRI



302 CYLINDRE ALUMINIUM



306 DRØVLEVENTILER



310 FILTER, REGULATOR
& SMØREAPPARATER



318 FILTER, REGULATOR &
SMØREAPPARATER RS



320 TRYKLUFFILTRE



323 KOMPRESSIONS
FITTINGS MS INDUSTRI



328 SWIVEL FITTINGS



330 PUSH-IN FITTINGS
RUSTFRI AISI 316



334 PUSH-IN FITTINGS
MESSING HØJTRYK



335 STØDDÆMPERE



339 DIVERSE
LYNKOBLINGER



361 JWL KOBLINGER OG
TRYKLUFFPISTOLER



364 PNEUMATISKE
VIBRATORER

PUSH-IN FITTINGS PLAST/MESSING



Max 10 bar



0°C til +60°C



Plast/messing push-in fittings. Denne serie er en af de mest funktionsstabile serier af push-in fittings, fremstillet under streng kvalitetskontrol. Serien udmærker sig ved en enorm mængde forskellige tilslutningsmuligheder og varianter af fittingstyper.

Bemærk at der altid medfølger O-ring til denne type fittings, når de er udstyret med BSPP udv. gevind.

PLASTFITTINGS PUSH-IN TIL LUFT

ADVARSEL

Læs venligst følgende sikkerhedsinstruktioner, inden du bruger push-in fittings.

- Denne type fittings er beregnet til komprimeret luft. Brug dem ikke til andet.
- Vær opmærksom på luftens temperatur, max 60°C. Undgå at bruge disse fittings i varme områder eller i nærheden af åben ild.
- Vær opmærksom på omgivelserne og miljøet, som fittings bliver installeret i. Undgå kemikalier eller ætsende påvirkning.
- Undgå at udsætte fittingsdele for sving eller vippebevægelser, da dette kan medføre skade på fittingsdelen.
- Undgå at der kommer partikler og støv ind i fittings under opbevaring.
- Følg skemaet for tilspænding.

TILSPÆNDING OG GEVIND

Gevind Korrekt tilspænding N.m (kgf.cm)

M5	1.5 ~2 (15~20)
1/8	7 ~9 (70~90)
1/4	12 ~14 (120~140)
3/8	22 ~24 (220~240)
1/2	28 ~30 (280~300)

- Ved brug af teflontape skal tapen omvikles som vist på nedenstående skitse.

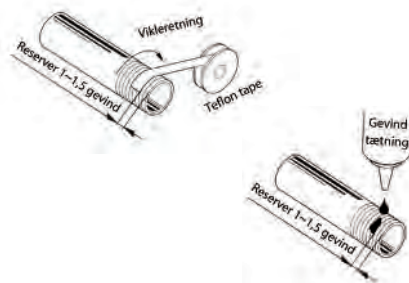

- Ved brug af flydende pakning, undgå overforbrug samt at væsken løber ind i fittingsdelen. Dette kan forårsage låsning af swivelfittings eller forstøppe hele systemet.
- Alle rør skal afskæres i 90° vinkel og skal afgrates. Der må ikke forekomme ridser på røret. Røret skal være rundt evt. kalibreret. Vores PA, PE og PU slanger er alle kalibreret.
- Røret skal altid skubbes i bund i fittingsdelen.
- Mærk evt. røret op for at kontrollere at det kommer helt i bund. Der kan forekomme lækage eller endnu værre, røret kan skydes ud af fittingsdelen, hvis det ikke er monteret korrekt.

VEDLIGEHOLDELSE AF SYSTEMET

Når røret skal trækkes ud af fittingsdelen:

1. Kontroller, at der ikke er tryk på slangen/røret.
2. Tryk klemringen ensartet mod fittingsdelen og træk røret ud.
3. Hvis røret afmonteres regelmæssigt, skal dybe klemmærker afskæres for at få et godt greb.

Regelmæssig kontrol:

1. Tjek for dybe ridser i røret, lækage og andet slid.
2. Lækage af luft ved fittings.
3. Hærdning, deformation af rør.
4. Se efter unormale rør og fittingsamlinger.

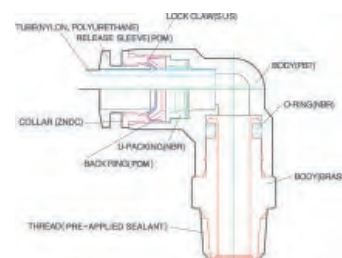

Nippel push-in

MESSING - BSPT



Varenr.	ø × BSPT	DKK
EC80K-0418	4 × 1/8"	15,45
EC80K-0414	4 × 1/4"	15,85
EC80K-0438	4 × 3/8"	20,55
EC80K-0618	6 × 1/8"	16,75
EC80K-0614	6 × 1/4"	17,65
EC80K-0638	6 × 3/8"	22,15
EC80K-0612	6 × 1/2"	27,45
EC80K-0818	8 × 1/8"	19,95
EC80K-0814	8 × 1/4"	20,55
EC80K-0838	8 × 3/8"	22,75
EC80K-0812	8 × 1/2"	33,90
EC80K-1018	10 × 1/8"	24,70
EC80K-1014	10 × 1/4"	24,10
EC80K-1038	10 × 3/8"	24,10
EC80K-1012	10 × 1/2"	30,10
EC80K-1218	12 × 1/8"	30,90
EC80K-1214	12 × 1/4"	24,40
EC80K-1238	12 × 3/8"	31,50
EC80K-1212	12 × 1/2"	35,05
EC80K-1638	16 × 3/8"	110,50
EC80K-1612	16 × 1/2"	110,50

Push-in har en ring med bagudrettede tænder, der griber ind i slangen og hindrer, at man kan trække slangen ud. Udløseringen presser tænderne væk fra slangen, der så kan tages ud af fittingen.

Selve tætningen er en O-ring, placeret lige under de tænder, der fastholder slangen i fittingen. O-ringstype se teknisk beskrivelse.

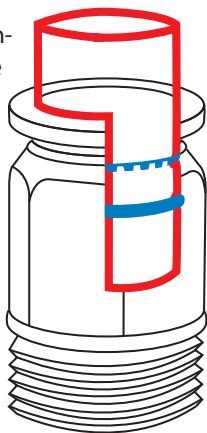

Nippel push-in rund

MESSING - BSPT



Varenr.	ø × BSPT	DKK
EC80RK-0418	4 × 1/8"	20,55
EC80RK-0414	4 × 1/4"	20,90
EC80RK-0438	4 × 3/8"	26,00
EC80RK-0618	6 × 1/8"	22,50
EC80RK-0614	6 × 1/4"	23,40
EC80RK-0638	6 × 3/8"	29,25
EC80RK-0818	8 × 1/8"	26,55
EC80RK-0814	8 × 1/4"	27,20
EC80RK-0838	8 × 3/8"	30,10
EC80RK-0812	8 × 1/2"	44,40
EC80RK-1018	10 × 1/8"	32,55
EC80RK-1014	10 × 1/4"	32,00
EC80RK-1038	10 × 3/8"	32,30
EC80RK-1012	10 × 1/2"	39,75
EC80RK-1218	12 × 1/8"	40,85
EC80RK-1214	12 × 1/4"	39,75
EC80RK-1238	12 × 3/8"	41,45
EC80RK-1212	12 × 1/2"	46,35

Nippel push-in

MESSING - BSPT



Til rør/slanger i tommemål		
Varenr.	ø × BSPT	DKK
EC83K-1418	1/4" × 1/8"	16,75
EC83K-1414	1/4" × 1/4"	17,65
EC83K-1438	1/4" × 3/8"	22,15
EC83K-51618	5/16" × 1/8"	19,95
EC83K-51614	5/16" × 1/4"	20,55
EC83K-51638	5/16" × 3/8"	22,75
EC83K-3818	3/8" × 1/8"	24,70
EC83K-3814	3/8" × 1/4"	24,10
EC83K-3838	3/8" × 3/8"	24,10
EC83K-3812	3/8" × 1/2"	30,10
EC83K-1214	1/2" × 1/4"	24,40
EC83K-1238	1/2" × 3/8"	31,50
EC83K-1212	1/2" × 1/2"	35,05

Nippel push-in

MESSING - BSPP



Varenr.	ø × BSPP	DKK
EC81C-04M5	4 × M5	20,55 α
EC81C-04M6	4 × M6	27,65 α
EC81C-0418	4 × 1/8"	15,45
EC81C-0414	4 × 1/4"	15,85
EC81C-0438	4 × 3/8"	19,65
EC81C-06M5	6 × M5	22,50 α
EC81C-06M6	6 × M6	32,30 α
EC81C-0618	6 × 1/8"	16,75
EC81C-0614	6 × 1/4"	17,65
EC81C-0638	6 × 3/8"	22,15
EC81C-0818	8 × 1/8"	20,25
EC81C-0814	8 × 1/4"	20,55
EC81C-0838	8 × 3/8"	22,75
EC81C-0812	8 × 1/2"	33,90
EC81C-1018	10 × 1/8"	24,70
EC81C-1014	10 × 1/4"	24,10
EC81C-1038	10 × 3/8"	24,10
EC81C-1012	10 × 1/2"	30,10
EC81C-1214	12 × 1/4"	30,35
EC81C-1238	12 × 3/8"	31,50
EC81C-1212	12 × 1/2"	35,05
EC81C-1638	16 × 3/8"	83,00
EC81C-1612	16 × 1/2"	93,10

α = ingen unbrako i nippelenden

Muffe push-in

MESSING - BSPT



Varenr.	ø × BSPT	DKK
EC82K-0418	4 × 1/8"	23,40
EC82K-0414	4 × 1/4"	25,30
EC82K-0438	4 × 3/8"	28,70
EC82K-0618	6 × 1/8"	25,30
EC82K-0614	6 × 1/4"	27,20
EC82K-0638	6 × 3/8"	30,90
EC82K-0612	6 × 1/2"	43,60
EC82K-0818	8 × 1/8"	32,85
EC82K-0814	8 × 1/4"	43,05
EC82K-0838	8 × 3/8"	43,35
EC82K-0812	8 × 1/2"	54,05
EC82K-1018	10 × 1/8"	36,20
EC82K-1014	10 × 1/4"	36,20
EC82K-1038	10 × 3/8"	45,25
EC82K-1012	10 × 1/2"	49,35
EC82K-1214	12 × 1/4"	48,30
EC82K-1238	12 × 3/8"	49,95
EC82K-1212	12 × 1/2"	54,35

Muffe push-in

MESSING - BSPP



Varenr.	ø × BSPP	DKK
EC82C-0418	4 × 1/8"	23,40
EC82C-0414	4 × 1/4"	25,30
EC82C-0438	4 × 3/8"	28,70
EC82C-0618	6 × 1/8"	25,30
EC82C-0614	6 × 1/4"	27,45
EC82C-0638	6 × 3/8"	30,90
EC82C-0818	8 × 1/8"	32,85
EC82C-0814	8 × 1/4"	43,05
EC82C-0838	8 × 3/8"	43,35
EC82C-0812	8 × 1/2"	54,05
EC82C-1018	10 × 1/8"	36,20
EC82C-1014	10 × 1/4"	36,20
EC82C-1038	10 × 3/8"	45,25
EC82C-1012	10 × 1/2"	49,35
EC82C-1214	12 × 1/4"	48,30
EC82C-1238	12 × 3/8"	49,95
EC82C-1212	12 × 1/2"	54,35

Union push-in

PBT / MESSING



Varenr.	ø	DKK
EC97-04	4	19,95
EC97-06	6	22,15
EC97-0604	6 × 4	22,15
EC97-08	8	22,75
EC97-0804	8 × 4	21,20
EC97-0806	8 × 6	24,10
EC97-10	10	25,55
EC97-1006	10 × 6	24,10
EC97-1008	10 × 8	32,00
EC97-12	12	34,75
EC97-1208	12 × 8	32,00
EC97-1210	12 × 10	33,10
EC97-16	16	93,10
EC97-1612	16 × 12	69,90

Vinkel 90° push-in

PBT / MESSING



Varenr.	ø	DKK
EC88-04	4	20,90
EC88-06	6	21,75
EC88-08	8	22,75
EC88-10	10	25,55
EC88-12	12	34,75
EC88-16	16	93,65

Vinkel 90° push-in/nip svivel

PBT / MESSING - BSPT



Varenr.	ø × BSPT	DKK
EC84K-0418	4 × 1/8"	23,05
EC84K-0414	4 × 1/4"	24,40
EC84K-0438	4 × 3/8"	26,30
EC84K-0618	6 × 1/8"	23,40
EC84K-0614	6 × 1/4"	25,55
EC84K-0638	6 × 3/8"	28,95
EC84K-0612	6 × 1/2"	34,50
EC84K-0818	8 × 1/8"	27,90
EC84K-0814	8 × 1/4"	28,95
EC84K-0838	8 × 3/8"	30,10
EC84K-0812	8 × 1/2"	44,15
EC84K-1018	10 × 1/8"	37,85
EC84K-1014	10 × 1/4"	37,25
EC84K-1038	10 × 3/8"	37,85
EC84K-1012	10 × 1/2"	45,25
EC84K-1218	12 × 1/8"	46,35
EC84K-1214	12 × 1/4"	45,50
EC84K-1238	12 × 3/8"	48,30
EC84K-1212	12 × 1/2"	49,65
EC84K-1638	16 × 3/8"	125,75
EC84K-1612	16 × 1/2"	132,00



Vinkel 90° push-in/nip svivel
PBT / MESSING - BSPP



Varenr.	ø × BSPP	DKK
EC84C-04M5	4 × M5	27,20
EC84C-04M6	4 × M6	28,95
EC84C-0418	4 × 1/8"	23,05
EC84C-0414	4 × 1/4"	24,40
EC84C-0438	4 × 3/8"	28,70
EC84C-06M5	6 × M5	27,45
EC84C-06M6	6 × M6	29,25
EC84C-0618	6 × 1/8"	23,40
EC84C-0614	6 × 1/4"	25,55
EC84C-0638	6 × 3/8"	29,25
EC84C-0818	8 × 1/8"	27,90
EC84C-0814	8 × 1/4"	28,95
EC84C-0838	8 × 3/8"	30,10
EC84C-0812	8 × 1/2"	44,15
EC84C-1018	10 × 1/8"	37,85
EC84C-1014	10 × 1/4"	37,25
EC84C-1038	10 × 3/8"	37,85
EC84C-1012	10 × 1/2"	45,25
EC84C-1214	12 × 1/4"	45,50
EC84C-1238	12 × 3/8"	46,95
EC84C-1212	12 × 1/2"	49,65
EC84C-1638	16 × 3/8"	125,00
EC84C-1612	16 × 1/2"	132,00

Vinkel 90° push-in/nip svivel
PBT / MESSING - BSPT



Varenr.	ø × BSPT	DKK
EC85LK-0418	4 × 1/8"	19,30
EC85LK-0414	4 × 1/4"	25,55
EC85LK-0438	4 × 3/8"	30,65
EC85LK-0618	6 × 1/8"	22,50
EC85LK-0614	6 × 1/4"	27,20
EC85LK-0638	6 × 3/8"	33,40
EC85LK-0612	6 × 1/2"	45,50
EC85LK-0818	8 × 1/8"	32,30
EC85LK-0814	8 × 1/4"	34,75
EC85LK-0838	8 × 3/8"	35,60
EC85LK-0812	8 × 1/2"	47,45
EC85LK-1218	12 × 1/8"	40,85
EC85LK-1214	12 × 1/4"	43,35
EC85LK-1238	12 × 3/8"	43,05
EC85LK-1212	12 × 1/2"	49,35

Vinkel 90° push-in/nip svivel
PBT / MESSING - BSPP



Varenr.	ø × BSPP	DKK
EC85LC-04M5	4 × M5	24,70
EC85LC-04M6	4 × M6	24,70
EC85LC-0418	4 × 1/8"	19,30
EC85LC-0414	4 × 1/4"	25,55
EC85LC-0438	4 × 3/8"	30,65
EC85LC-06M5	6 × M5	26,90
EC85LC-06M6	6 × M6	27,20
EC85LC-0618	6 × 1/8"	22,50
EC85LC-0614	6 × 1/4"	27,20
EC85LC-0638	6 × 3/8"	33,40
EC85LC-0818	8 × 1/8"	24,70
EC85LC-0814	8 × 1/4"	28,15
EC85LC-0838	8 × 3/8"	34,50
EC85LC-0812	8 × 1/2"	45,25
EC85LC-1018	10 × 1/8"	32,30
EC85LC-1014	10 × 1/4"	34,75
EC85LC-1038	10 × 3/8"	35,60
EC85LC-1012	10 × 1/2"	47,45
EC85LC-1214	12 × 1/4"	43,35
EC85LC-1238	12 × 3/8"	43,05
EC85LC-1212	12 × 1/2"	49,35



Vinkel 90° push-in/nip svivel

PBT / MESSING - BSPT



Varenr.	ø × BSPT	DKK
EC84LK-0418	4 × 1/8"	30,10
EC84LK-0438	4 × 3/8"	33,90
EC84LK-0414	4 × 1/4"	31,50
EC84LK-0618	6 × 1/8"	34,75
EC84LK-0614	6 × 1/4"	36,70
EC84LK-0638	6 × 3/8"	43,35
EC84LK-0612	6 × 1/2"	45,25
EC84LK-0818	8 × 1/8"	37,85
EC84LK-0814	8 × 1/4"	39,15
EC84LK-0838	8 × 3/8"	47,45
EC84LK-0812	8 × 1/2"	49,35
EC84LK-1018	10 × 1/8"	47,75
EC84LK-1014	10 × 1/4"	48,55
EC84LK-1038	10 × 3/8"	50,20
EC84LK-1012	10 × 1/2"	69,10
EC84LK-1218	12 × 1/8"	69,10
EC84LK-1214	12 × 1/4"	70,45
EC84LK-1238	12 × 3/8"	73,70
EC84LK-1212	12 × 1/2"	76,70

Vinkel 90° push-in/nip svivel

PBT / MESSING - BSPP



Varenr.	ø × BSPP	DKK
EC84LC-04M5	4 × M5	33,10
EC84LC-04M6	4 × M6	34,20
EC84LC-0418	4 × 1/8"	31,50
EC84LC-0414	4 × 1/4"	33,90
EC84LC-0438	4 × 3/8"	40,00
EC84LC-06M5	6 × M5	34,50
EC84LC-06M6	6 × M6	34,50
EC84LC-0618	6 × 1/8"	34,75
EC84LC-0614	6 × 1/4"	36,70
EC84LC-0638	6 × 3/8"	43,35
EC84LC-0818	8 × 1/8"	37,85
EC84LC-0814	8 × 1/4"	39,15
EC84LC-0838	8 × 3/8"	47,45
EC84LC-0812	8 × 1/2"	49,65
EC84LC-1018	10 × 1/8"	47,75
EC84LC-1014	10 × 1/4"	48,55
EC84LC-1038	10 × 3/8"	50,20
EC84LC-1012	10 × 1/2"	69,10
EC84LC-1214	12 × 1/4"	70,45
EC84LC-1238	12 × 3/8"	73,70
EC84LC-1212	12 × 1/2"	77,00

Vinkel 90° push-in/muf svivel

PBT / MESSING - BSPP



Varenr.	ø × BSPP	DKK
EC87C-04M5	4 × M5	28,95
EC87C-04M6	4 × M6	30,90
EC87C-0418	4 × 1/8"	24,70
EC87C-0414	4 × 1/4"	22,95
EC87C-06M5	6 × M5	29,50
EC87C-06M6	6 × M6	31,20
EC87C-0618	6 × 1/8"	21,80
EC87C-0614	6 × 1/4"	23,40
EC87C-0638	6 × 3/8"	33,65
EC87C-0818	8 × 1/8"	26,00
EC87C-0814	8 × 1/4"	27,20
EC87C-0838	8 × 3/8"	27,90
EC87C-0812	8 × 1/2"	40,85
EC87C-1018	10 × 1/8"	34,75
EC87C-1014	10 × 1/4"	34,75
EC87C-1038	10 × 3/8"	35,35
EC87C-1012	10 × 1/2"	42,20
EC87C-1214	12 × 1/4"	42,50
EC87C-1238	12 × 3/8"	50,50
EC87C-1212	12 × 1/2"	46,05

Vinkel 90° push-in/rørstykke

PBT / MESSING



Varenr.	ø × Ø	DKK
EC119-0404	4 × 4	33,10
EC119-0606	6 × 6	36,70
EC119-0806	6 × 8	24,40
EC119-0808	8 × 8	40,85
EC119-1010	10 × 10	41,95
EC119-1212	12 × 12	59,00
EC119-1616	16 × 16	55,20

Vinkel 45° push-in/rørstykke
PA (POLYAMID) / MESSING



Varenr.	ø × Ø	DKK
EC200-04	4	11,90
EC200-06	6	11,90
EC200-08	8	14,00
EC200-10	10	16,10
EC200-12	12	19,00

Vinkel 45° push-in/nippel
PA (POLYAMID) / MESSING - BSPP



Varenr.	ø × Ø	DKK
EC202-04M5	4×M5	19,80
EC202-0418	4×1/8"	19,80
EC202-06M5	6×M5	19,80
EC202-0618	6×1/8"	19,80
EC202-0614	6×1/4"	22,15
EC202-0818	8×1/8"	22,15
EC202-0814	8×1/4"	24,35
EC202-0838	8×3/8"	29,15
EC202-1014	10×1/4"	32,05
EC202-1038	10×3/8"	35,75
EC202-1012	10×1/2"	39,05
EC202-1214	12×1/4"	36,30
EC202-1238	12×3/8"	40,25
EC202-1212	12×1/2"	43,15

T-stk push-in
PBT / MESSING



Varenr.	ø	DKK
EC94-04	4	33,40
EC94-06	6	33,40
EC94-0604	6 × 4 × 6	34,20
EC94-08	8	34,75
EC94-0806	8 × 6 × 8	35,60
EC94-10	10	36,45
EC94-1006	10 × 6 × 10	44,70
EC94-1008	10 × 8 × 10	52,70
EC94-12	12	51,00
EC94-1208	12 × 8 × 12	58,45
EC94-1210	12 × 10 × 12	65,55
EC94-16	16	90,65
EC94-1610	16 × 10 × 16	102,50
EC94-1612	16 × 12 × 16	109,00

Vinkel 45° push-in/nippel
PA (POLYAMID) / MESSING - BSPT



Varenr.	ø × Ø	DKK
EC201-0418	4×1/8"	19,80
EC201-0618	6×1/8"	19,80
EC201-0614	6×1/4"	22,15
EC201-0818	8×1/8"	22,15
EC201-0814	8×1/4"	24,35
EC201-0838	8×3/8"	29,15
EC201-1014	10×1/4"	32,05
EC201-1038	10×3/8"	35,75
EC201-1012	10×1/2"	39,05
EC201-1214	12×1/4"	36,30
EC201-1238	12×3/8"	40,25
EC201-1212	12×1/2"	43,15

Vinkel 45° push-in
PA (POLYAMID) / MESSING



Varenr.	ø × Ø	DKK
EC203-04	4	19,00
EC203-06	6	19,80
EC203-08	8	23,00
EC203-10	10	30,05
EC203-12	12	39,05

T-stk nip/push-in/muf svivel

PBT / MESSING - BSPT×BSPP



Varenr.	BSPT × ø × BSPP	DKK
EC104K-0418	1/8" × 4 × 1/8"	37,25
EC104K-0618	1/8" × 6 × 1/8"	44,15
EC104K-0614	1/4" × 6 × 1/4"	44,15
EC104K-0818	1/8" × 8 × 1/8"	49,35
EC104K-0814	1/4" × 8 × 1/4"	49,35
EC104K-0838	3/8" × 8 × 3/8"	56,85
EC104K-1014	1/4" × 10 × 1/4"	49,35
EC104K-1038	3/8" × 10 × 3/8"	56,50
EC104K-1238	3/8" × 12 × 3/8"	84,65
EC104K-1212	1/2" × 12 × 1/2"	97,20

T-stk nip/push-in/muf svivel

PBT / MESSING - BSPP



Varenr.	BSPP × ø × BSPP	DKK
EC180C-04M5	M5 × 4 × M5	37,50
EC180C-04M6	M6 × 4 × M6	37,50
EC180C-0418	1/8" × 4 × 1/8"	53,80
EC180C-0414	1/4" × 4 × 1/4"	80,55
EC180C-0438	3/8" × 4 × 3/8"	110,25
EC180C-0412	1/2" × 4 × 1/2"	145,25
EC180C-06M5	M5 × 6 × M5	43,85
EC180C-06M6	M6 × 6 × M6	43,85
EC180C-0618	1/8" × 6 × 1/8"	58,75
EC180C-0614	1/4" × 6 × 1/4"	82,15
EC180C-0638	3/8" × 6 × 3/8"	112,25
EC180C-0612	1/2" × 6 × 1/2"	146,50
EC180C-0818	1/8" × 8 × 1/8"	60,90
EC180C-0814	1/4" × 8 × 1/4"	83,80
EC180C-0838	3/8" × 8 × 3/8"	113,75
EC180C-0812	1/2" × 8 × 1/2"	149,00
EC180C-1018	1/8" × 10 × 1/8"	64,45
EC180C-1014	1/4" × 10 × 1/4"	87,35
EC180C-1038	3/8" × 10 × 3/8"	117,00
EC180C-1012	1/2" × 10 × 1/2"	151,50
EC180C-1214	1/4" × 12 × 1/4"	93,10
EC180C-1238	3/8" × 12 × 3/8"	123,25
EC180C-1212	1/2" × 12 × 1/2"	158,25

T-stk push-in/nip svivel gren

PBT / MESSING - BSPT



Varenr.	ø × BSPT × ø	DKK
EC89K-0418	4 × 1/8" × 4	30,35
EC89K-0414	4 × 1/4" × 4	32,00
EC89K-0438	4 × 3/8" × 4	37,25
EC89K-0618	6 × 1/8" × 6	33,10
EC89K-0614	6 × 1/4" × 6	34,75
EC89K-0638	6 × 3/8" × 6	40,25
EC89K-0612	6 × 1/2" × 6	53,30
EC89K-0818	8 × 1/8" × 8	38,10
EC89K-0814	8 × 1/4" × 8	38,90
EC89K-0838	8 × 3/8" × 8	40,85
EC89K-0812	8 × 1/2" × 8	54,05
EC89K-1018	10 × 1/8" × 10	46,95
EC89K-1014	10 × 1/4" × 10	48,00
EC89K-1038	10 × 3/8" × 10	50,75
EC89K-1012	10 × 1/2" × 10	56,00
EC89K-1218	12 × 1/8" × 12	54,35
EC89K-1214	12 × 1/4" × 12	55,20
EC89K-1238	12 × 3/8" × 12	56,85
EC89K-1212	12 × 1/2" × 12	59,25
EC89K-1638	16 × 3/8" × 16	170,25
EC89K-1612	16 × 1/2" × 16	177,00

T-stk push-in/nip svivel gren

PBT / MESSING - BSPP



Varenr.	ø × BSPP × ø	DKK
EC89C-04M5	4 × M5 × 4	34,50
EC89C-04M6	4 × M6 × 4	37,85
EC89C-0418	4 × 1/8" × 4	30,35
EC89C-0414	4 × 1/4" × 4	32,00
EC89C-0438	4 × 3/8" × 4	37,50
EC89C-06M5	6 × M5 × 6	37,85
EC89C-06M6	6 × M6 × 6	37,85
EC89C-0618	6 × 1/8" × 6	33,10
EC89C-0614	6 × 1/4" × 6	34,75
EC89C-0638	6 × 3/8" × 6	40,25
EC89C-0818	8 × 1/8" × 8	38,10
EC89C-0814	8 × 1/4" × 8	38,90
EC89C-0838	8 × 3/8" × 8	40,85
EC89C-0812	8 × 1/2" × 8	54,05
EC89C-1018	10 × 1/8" × 10	47,45
EC89C-1014	10 × 1/4" × 10	48,00
EC89C-1038	10 × 3/8" × 10	50,75
EC89C-1012	10 × 1/2" × 10	56,00
EC89C-1214	12 × 1/4" × 12	55,20
EC89C-1238	12 × 3/8" × 12	56,85
EC89C-1212	12 × 1/2" × 12	59,25
EC89C-1638	16 × 3/8" × 16	150,25
EC89C-1612	16 × 1/2" × 16	158,25

T-stk push-in/muf svivel gren PBT / MESSING - BSPT



Varenr.	ø × BSPT × ø	DKK
EC90K-0418	4 × 1/8" × 4	30,35
EC90K-0414	4 × 1/4" × 4	32,55
EC90K-0618	6 × 1/8" × 6	33,10
EC90K-0614	6 × 1/4" × 6	34,75
EC90K-0638	6 × 3/8" × 6	40,25
EC90K-0818	8 × 1/8" × 8	38,10
EC90K-0814	8 × 1/4" × 8	38,90
EC90K-0838	8 × 3/8" × 8	40,85
EC90K-0812	8 × 1/2" × 8	50,75
EC90K-1018	10 × 1/8" × 10	48,00
EC90K-1014	10 × 1/4" × 10	48,00
EC90K-1038	10 × 3/8" × 10	50,50
EC90K-1012	10 × 1/2" × 10	56,00
EC90K-1214	12 × 1/4" × 12	55,20
EC90K-1238	12 × 3/8" × 12	56,85
EC90K-1212	12 × 1/2" × 12	59,25

T-stk push-in/muf svivel gren PBT / MESSING - BSPP



Varenr.	ø × BSPP × ø	DKK
EC90C-04M5	4 × M5 × 4	34,20
EC90C-04M6	4 × M6 × 4	37,85
EC90C-0418	4 × 1/8" × 4	30,35
EC90C-0414	4 × 1/4" × 4	32,55
EC90C-06M5	6 × M5 × 6	37,85
EC90C-06M6	6 × M6 × 6	37,85
EC90C-0618	6 × 1/8" × 6	33,10
EC90C-0614	6 × 1/4" × 6	34,75
EC90C-0638	6 × 3/8" × 6	40,25
EC90C-0818	8 × 1/8" × 8	38,10
EC90C-0814	8 × 1/4" × 8	38,90
EC90C-0838	8 × 3/8" × 8	40,85
EC90C-0812	8 × 1/2" × 8	54,35
EC90C-1018	10 × 1/8" × 10	48,00
EC90C-1014	10 × 1/4" × 10	48,00
EC90C-1038	10 × 3/8" × 10	50,50
EC90C-1012	10 × 1/2" × 10	56,00
EC90C-1214	12 × 1/4" × 12	55,20
EC90C-1238	12 × 3/8" × 12	56,85
EC90C-1212	12 × 1/2" × 12	59,25

T-stk push-in/nip svivel ende PBT / MESSING - BSPT



Varenr.	ø × ø × BSPT	DKK
EC92K-0418	4 × 4 × 1/8"	32,30
EC92K-0414	4 × 4 × 1/4"	32,30
EC92K-0438	4 × 4 × 3/8"	32,30
EC92K-0618	6 × 6 × 1/8"	32,30
EC92K-0614	6 × 6 × 1/4"	32,30
EC92K-0638	6 × 6 × 3/8"	39,15
EC92K-0612	6 × 6 × 1/2"	48,85
EC92K-0818	8 × 8 × 1/8"	34,20
EC92K-0814	8 × 8 × 1/4"	34,20
EC92K-0838	8 × 8 × 3/8"	39,40
EC92K-0812	8 × 8 × 1/2"	48,85
EC92K-1018	10 × 10 × 1/8"	40,25
EC92K-1014	10 × 10 × 1/4"	39,40
EC92K-1038	10 × 10 × 3/8"	39,40
EC92K-1012	10 × 10 × 1/2"	41,70
EC92K-1218	12 × 12 × 1/8"	43,85
EC92K-1214	12 × 12 × 1/4"	47,75
EC92K-1238	12 × 12 × 3/8"	54,85
EC92K-1212	12 × 12 × 1/2"	65,55

T-stk push-in/nip svivel ende PBT / MESSING - BSPP



Varenr.	ø × ø × BSPP	DKK
EC92C-04M5	4 × 4 × M5	32,30
EC92C-04M6	4 × 4 × M6	32,30
EC92C-0418	4 × 4 × 1/8"	32,30
EC92C-0414	4 × 4 × 1/4"	32,30
EC92C-0438	4 × 4 × 3/8"	32,30
EC92C-06M5	6 × 6 × M5	32,30
EC92C-06M6	6 × 6 × M6	32,30
EC92C-0618	6 × 6 × 1/8"	32,30
EC92C-0614	6 × 6 × 1/4"	32,30
EC92C-0638	6 × 6 × 3/8"	39,40
EC92C-0818	8 × 8 × 1/8"	34,20
EC92C-0814	8 × 8 × 1/4"	34,20
EC92C-0838	8 × 8 × 3/8"	39,40
EC92C-0812	8 × 8 × 1/2"	48,85
EC92C-1018	10 × 10 × 1/8"	36,20
EC92C-1014	10 × 10 × 1/4"	39,40
EC92C-1038	10 × 10 × 3/8"	39,40
EC92C-1012	10 × 10 × 1/2"	41,45
EC92C-1214	12 × 12 × 1/4"	48,00
EC92C-1238	12 × 12 × 3/8"	54,85
EC92C-1212	12 × 12 × 1/2"	65,55

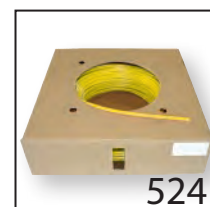

524

Fordeler nippel/push-in

PBT / MESSING - BSPT



Varenr.	ø × BSPT × ø	DKK
EC170K-0418	4 × 1/8" × 4	84,65
EC170K-0414	4 × 1/4" × 4	107,75
EC170K-0438	4 × 3/8" × 4	144,00
EC170K-0412	4 × 1/2" × 4	183,50
EC170K-0618	6 × 1/8" × 6	87,65
EC170K-0614	6 × 1/4" × 6	111,00
EC170K-0638	6 × 3/8" × 6	151,50
EC170K-0612	6 × 1/2" × 6	186,75
EC170K-0818	8 × 1/8" × 8	91,50
EC170K-0814	8 × 1/4" × 8	115,00
EC170K-0838	8 × 3/8" × 8	151,50
EC170K-0812	8 × 1/2" × 8	190,75
EC170K-1018	10 × 1/8" × 10	99,70
EC170K-1014	10 × 1/4" × 10	122,75
EC170K-1038	10 × 3/8" × 10	158,25
EC170K-1012	10 × 1/2" × 10	198,75
EC170K-1214	12 × 1/4" × 12	135,50
EC170K-1238	12 × 3/8" × 12	170,25
EC170K-1212	12 × 1/2" × 12	210,75

Fordeler nippel/push-in

PBT / MESSING - BSPP



Varenr.	ø × BSPP × ø	DKK
EC171C-0418	4 × 1/8" × 4	84,65
EC171C-0414	4 × 1/4" × 4	107,75
EC171C-0438	4 × 3/8" × 4	144,00
EC171C-0412	4 × 1/2" × 4	183,50
EC171C-0618	6 × 1/8" × 6	87,65
EC171C-0614	6 × 1/4" × 6	111,00
EC171C-0638	6 × 3/8" × 6	151,50
EC171C-0612	6 × 1/2" × 6	186,75
EC171C-0818	8 × 1/8" × 8	91,50
EC171C-0814	8 × 1/4" × 8	115,00
EC171C-0838	8 × 3/8" × 8	151,50
EC171C-0812	8 × 1/2" × 8	190,75
EC171C-1018	10 × 1/8" × 10	99,70
EC171C-1014	10 × 1/4" × 10	122,75
EC171C-1038	10 × 3/8" × 10	158,25
EC171C-1012	10 × 1/2" × 10	198,75
EC171C-1214	12 × 1/4" × 12	135,50
EC171C-1238	12 × 3/8" × 12	170,25
EC171C-1212	12 × 1/2" × 12	210,75

T-stk push-in/rørende

PBT / MESSING



Varenr.	ø × ø × ø	DKK
EC93-0404	4	33,40
EC93-0604	4 × 4 × 6	34,20
EC93-0606	6	33,40
EC93-0806	6 × 6 × 8	35,60
EC93-0808	8	34,75
EC93-1008	8 × 8 × 10	52,70
EC93-1010	10	36,70
EC93-1210	10 × 10 × 12	65,55
EC93-1212	12	51,00

T-stk push-in/rørgren

PBT / MESSING



Varenr.	ø × ø × ø	DKK
EC91-0404	4	33,40
EC91-0604	4 × 6 × 4	34,20
EC91-0606	6	33,40
EC91-0806	6 × 8 × 6	35,60
EC91-0808	8	34,75
EC91-1008	8 × 10 × 8	52,70
EC91-1010	10	36,70
EC91-1210	10 × 12 × 10	65,55
EC91-1212	12	51,00

Kryds push-in

PBT / MESSING

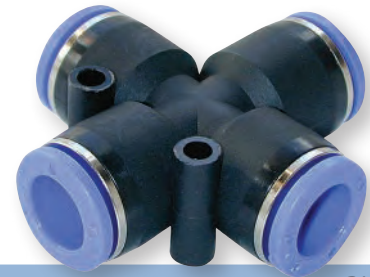

Varenr.	ø	DKK
EC95-04	4	48,85
EC95-06	6	54,35
EC95-08	8	56,00
EC95-10	10	64,20
EC95-12	12	75,35

Y-stk nippel svivel/push-in

PBT / MESSING - BSPT



Varenr.	BSPT × dim	DKK
EC113K-0418	1/8" × 2-ø4	40,00
EC113K-0414	1/4" × 2-ø4	40,00
EC113K-0438	3/8" × 2-ø4	40,00
EC113K-0618	1/8" × 2-ø6	40,00
EC113K-0614	1/4" × 2-ø6	40,00
EC113K-0638	3/8" × 2-ø6	46,95
EC113K-0612	1/2" × 2-ø6	46,95
EC113K-0818	1/8" × 2-ø8	46,95
EC113K-0814	1/4" × 2-ø8	46,95
EC113K-0838	3/8" × 2-ø8	46,95
EC113K-0812	1/2" × 2-ø8	49,65
EC113K-1018	1/8" × 2-ø10	48,55
EC113K-1014	1/4" × 2-ø10	43,85
EC113K-1038	3/8" × 2-ø10	46,95
EC113K-1012	1/2" × 2-ø10	55,20
EC113K-1218	1/8" × 2-ø12	55,20
EC113K-1214	1/4" × 2-ø12	59,25
EC113K-1238	3/8" × 2-ø12	79,20
EC113K-1212	1/2" × 2-ø12	87,10

Y-stk nippel svivel/push-in

PBT / MESSING - BSPP



Varenr.	BSPP × dim	DKK
EC113C-04M5	M5 × 2-ø4	40,00
EC113C-04M6	M6 × 2-ø4	40,00
EC113C-0418	1/8" × 2-ø4	40,00
EC113C-0414	1/4" × 2-ø4	40,00
EC113C-0438	3/8" × 2-ø4	40,00
EC113C-06M5	M5 × 2-ø6	40,00
EC113C-06M6	M6 × 2-ø6	40,00
EC113C-0618	1/8" × 2-ø6	40,00
EC113C-0614	1/4" × 2-ø6	40,00
EC113C-0638	3/8" × 2-ø6	46,95
EC113C-0818	1/8" × 2-ø8	46,65
EC113C-0814	1/4" × 2-ø8	46,65
EC113C-0838	3/8" × 2-ø8	46,95
EC113C-0812	1/2" × 2-ø8	49,65
EC113C-1018	1/8" × 2-ø10	48,55
EC113C-1014	1/4" × 2-ø10	43,85
EC113C-1038	3/8" × 2-ø10	46,95
EC113C-1012	1/2" × 2-ø10	55,20
EC113C-1214	1/4" × 2-ø12	59,25
EC113C-1238	3/8" × 2-ø12	79,20
EC113C-1212	1/2" × 2-ø12	87,10

Fordeler rørstykke/push-in

PBT / MESSING



Varenr.	dim	DKK
EC144-0604	Ø6 × 4-ø4	74,00
EC144-0806	Ø8 × 4-ø6	90,65

Fordeler nippel/push-in

PBT / MESSING - BSPT



Varenr.	BSPT × dim	DKK
EC137-0418	1/8" × 4-ø4	69,10
EC137-0414	1/4" × 4-ø4	69,90
EC137-0618	1/8" × 4-ø6	112,75
EC137-0614	1/4" × 4-ø6	112,75

Y-stk push-in

PBT / MESSING



Varenr.	dim	DKK
EC111-04	ø4 × 2-ø4	43,35
EC111-0604	ø6 × 2-ø4	31,50
EC111-06	ø6 × 2-ø6	43,35
EC111-0804	ø8 × 2-ø4	39,75
EC111-0806	ø8 × 2-ø6	33,10
EC111-08	ø8 × 2-ø8	43,05
EC111-1006	ø10 × 2-ø6	43,85
EC111-1008	ø10 × 2-ø8	38,10
EC111-10	ø10 × 2-ø10	48,00
EC111-1208	ø12 × 2-ø8	49,65
EC111-1210	ø12 × 2-ø10	50,75
EC111-12	ø12 × 2-ø12	59,25

Y-stk rørstykke/push-in

PBT / MESSING



Varenr.	dim	DKK
EC114-0404	Ø4 × 2-ø4	44,70
EC114-0604	Ø6 × 2-ø4	62,30
EC114-0606	Ø6 × 2-ø6	62,00
EC114-0806	Ø8 × 2-ø6	68,50
EC114-0808	Ø8 × 2-ø8	69,35
EC114-1008	Ø10 × 2-ø8	75,90
EC114-1010	Ø10 × 2-ø10	76,70
EC114-1210	Ø12 × 2-ø10	89,00
EC114-1212	Ø12 × 2-ø12	88,45

Fordeler push-in

PBT / MESSING



Varenr.	ø × dim	DKK
EC138-0604	6 × 4-ø4	63,65
EC138-0806	8 × 4-ø6	86,05

Skotgennemfør push-in/muffe

MESSING - BSPT



Varenr.	ø × BSPT	Ext. dim.	DKK
EC112K-0418	4 × 1/8"	M12*1	43,60
EC112K-0414	4 × 1/4"	M12*1	43,85
EC112K-0438	4 × 3/8"	M12*1	44,15
EC112K-0618	6 × 1/8"	M14*1	46,05
EC112K-0614	6 × 1/4"	M14*1	47,45
EC112K-0638	6 × 3/8"	M14*1	48,00
EC112K-0818	8 × 1/8"	M16*1	52,70
EC112K-0814	8 × 1/4"	M16*1	54,85
EC112K-0838	8 × 3/8"	M16*1	57,35
EC112K-0812	8 × 1/2"	M16*1	60,05
EC112K-1018	10 × 1/8"	M20*1	67,20
EC112K-1014	10 × 1/4"	M20*1	69,90
EC112K-1038	10 × 3/8"	M20*1	73,45
EC112K-1012	10 × 1/2"	M20*1	76,70
EC112K-1214	12 × 1/4"	M22*1	77,85
EC112K-1238	12 × 3/8"	M22*1	82,50
EC112K-1212	12 × 1/2"	M22*1	88,45

Skotgennemfør push-in/muffe

MESSING - BSPP



Varenr.	ø × BSPP	Ext. dim.	DKK
EC112C-0418	4 × 1/8"	M12*1	43,60
EC112C-0414	4 × 1/4"	M12*1	43,85
EC112C-0438	4 × 3/8"	M12*1	44,15
EC112C-0618	6 × 1/8"	M14*1	46,05
EC112C-0614	6 × 1/4"	M14*1	47,45
EC112C-0638	6 × 3/8"	M14*1	48,00
EC112C-0818	8 × 1/8"	M16*1	52,70
EC112C-0814	8 × 1/4"	M16*1	54,85
EC112C-0838	8 × 3/8"	M16*1	57,35
EC112C-1018	10 × 1/8"	M20*1	67,20
EC112C-1014	10 × 1/4"	M20*1	69,90
EC112C-1038	10 × 3/8"	M20*1	73,45
EC112C-1012	10 × 1/2"	M20*1	76,70
EC112C-1214	12 × 1/4"	M22*1	77,85
EC112C-1238	12 × 3/8"	M22*1	82,50
EC112C-1212	12 × 1/2"	M22*1	88,45

Skotgennemføring push-in

PBT / MESSING



Varenr.	ø	Ext. dim	DKK
EC100-04	4	M12*1,25	28,15
EC100-06	6	M15*1,5	28,95
EC100-08	8	M17*1,5	30,35
EC100-10	10	M20*1,75	39,15
EC100-12	12	M24*1,75	42,75

Skotgennemføring push-in

MESSING



Varenr.	ø	Ext. dim	DKK
EC98-04	4	M12*1	35,35
EC98-06	6	M14*1	44,15
EC98-08	8	M16*1	53,30
EC98-10	10	M20*1	77,00
EC98-12	12	M22*1	104,00

Skotgennemføring 90° push-in

PBT / MESSING



Varenr.	ø	Ext. dim	DKK
EC181-04	4	M12*1	72,65
EC181-06	6	M14*1	90,35
EC181-08	8	M16*1	110,75
EC181-10	10	M20*1	155,75
EC181-12	12	M22*1	194,50

Banjo push-in/nippel

PBT / MESSING - BSPT



Varenr.	ø × BSPT	DKK
EC103K-0418	4 × 1/8"	37,25
EC103K-0414	4 × 1/4"	35,05
EC103K-0618	6 × 1/8"	44,15
EC103K-0614	6 × 1/4"	44,15
EC103K-0638	6 × 3/8"	50,75
EC103K-0612	6 × 1/2"	56,50
EC103K-0818	8 × 1/8"	49,35
EC103K-0814	8 × 1/4"	49,65
EC103K-0838	8 × 3/8"	56,85
EC103K-0812	8 × 1/2"	56,25
EC103K-1018	10 × 1/8"	49,35
EC103K-1014	10 × 1/4"	49,35
EC103K-1038	10 × 3/8"	56,50
EC103K-1012	10 × 1/2"	74,00
EC103K-1214	12 × 1/4"	44,15
EC103K-1238	12 × 3/8"	84,65
EC103K-1212	12 × 1/2"	97,20

Banjo push-in/nippel

PBT / MESSING - BSPP



Varenr.	ø × BSPP	DKK
EC103C-03M5	3 × M5	34,30
EC103C-04M5	4 × M5	37,50
EC103C-04M6	4 × M6	37,50
EC103C-0418	4 × 1/8"	37,50
EC103C-0414	4 × 1/4"	37,50
EC103C-06M5	6 × M5	43,85
EC103C-06M6	6 × M6	43,85
EC103C-0618	6 × 1/8"	44,15
EC103C-0614	6 × 1/4"	44,15
EC103C-0638	6 × 3/8"	50,75
EC103C-0818	8 × 1/8"	49,35
EC103C-0814	8 × 1/4"	49,65
EC103C-0838	8 × 3/8"	56,85
EC103C-0812	8 × 1/2"	65,55
EC103C-1014	10 × 1/4"	49,35
EC103C-1038	10 × 3/8"	56,50
EC103C-1012	10 × 1/2"	74,00
EC103C-1238	12 × 3/8"	84,65
EC103C-1212	12 × 1/2"	97,20

Fordeler nippel/push-in

PBT / MESSING - BSPT



Varenr.	BSPT × dim	DKK
EC172K-0418	1/8" × 2-ø4	121,25
EC172K-0414	1/4" × 2-ø4	155,75
EC172K-0438	3/8" × 2-ø4	204,75
EC172K-0412	1/2" × 2-ø4	262,00
EC172K-0618	1/8" × 2-ø6	124,50
EC172K-0614	1/4" × 2-ø6	159,50
EC172K-0638	3/8" × 2-ø6	207,75
EC172K-0612	1/2" × 2-ø6	265,25
EC172K-0818	1/8" × 2-ø8	128,75
EC172K-0814	1/4" × 2-ø8	163,00
EC172K-0838	3/8" × 2-ø8	212,25
EC172K-0812	1/2" × 2-ø8	269,00
EC172K-1018	1/8" × 2-ø10	136,50
EC172K-1014	1/4" × 2-ø10	170,25
EC172K-1038	3/8" × 2-ø10	218,25
EC172K-1012	1/2" × 2-ø10	276,50
EC172K-1214	1/4" × 2-ø12	253,75
EC172K-1238	3/8" × 2-ø12	315,75
EC172K-1212	1/2" × 2-ø12	390,25

Fordeler nippel/push-in

PBT / MESSING - BSPP



Varenr.	BSPP × dim	DKK
EC173C-0418	1/8" × 2-ø4	121,25
EC173C-0414	1/4" × 2-ø4	155,75
EC173C-0438	3/8" × 2-ø4	204,75
EC173C-0412	1/2" × 2-ø4	262,00
EC173C-0618	1/8" × 2-ø6	124,50
EC173C-0614	1/4" × 2-ø6	159,50
EC173C-0638	3/8" × 2-ø6	207,75
EC173C-0612	1/2" × 2-ø6	265,25
EC173C-0818	1/8" × 2-ø8	128,75
EC173C-0814	1/4" × 2-ø8	163,00
EC173C-0838	3/8" × 2-ø8	210,75
EC173C-0812	1/2" × 2-ø8	269,00
EC173C-1018	1/8" × 2-ø10	136,50
EC173C-1014	1/4" × 2-ø10	170,25
EC173C-1038	3/8" × 2-ø10	218,25
EC173C-1012	1/2" × 2-ø10	276,50
EC173C-1214	1/4" × 2-ø12	253,75
EC173C-1238	3/8" × 2-ø12	315,75
EC173C-1212	1/2" × 2-ø12	390,25





Fordeler nippel/push-in
PBT / MESSING - BSPT



Varenr.	BSPT x dim	DKK
EC174K-0418	1/8" x 3-ø4	158,25
EC174K-0414	1/4" x 3-ø4	213,50
EC174K-0438	3/8" x 3-ø4	275,00
EC174K-0412	1/2" x 3-ø4	347,25
EC174K-0618	1/8" x 3-ø6	163,00
EC174K-0614	1/4" x 3-ø6	218,25
EC174K-0638	3/8" x 3-ø6	280,75
EC174K-0612	1/2" x 3-ø6	352,75
EC174K-0818	1/8" x 3-ø8	169,00
EC174K-0814	1/4" x 3-ø8	223,75
EC174K-0838	3/8" x 3-ø8	285,75
EC174K-0812	1/2" x 3-ø8	358,50
EC174K-1018	1/8" x 3-ø10	181,25
EC174K-1014	1/4" x 3-ø10	235,00
EC174K-1038	3/8" x 3-ø10	296,75
EC174K-1012	1/2" x 3-ø10	370,00
EC174K-1214	1/4" x 3-ø12	253,75
EC174K-1238	3/8" x 3-ø12	315,75
EC174K-1212	1/2" x 3-ø12	390,25

Fordeler nippel/push-in
PBT / MESSING - BSPP



Varenr.	BSPP x dim	DKK
EC175C-0418	1/8" x 3-ø4	158,25
EC175C-0414	1/4" x 3-ø4	213,50
EC175C-0438	3/8" x 3-ø4	275,00
EC175C-0412	1/2" x 3-ø4	347,25
EC175C-0618	1/8" x 3-ø6	163,00
EC175C-0614	1/4" x 3-ø6	218,25
EC175C-0638	3/8" x 3-ø6	280,75
EC175C-0612	1/2" x 3-ø6	352,75
EC175C-0818	1/8" x 3-ø8	169,00
EC175C-0814	1/4" x 3-ø8	223,75
EC175C-0838	3/8" x 3-ø8	285,75
EC175C-0812	1/2" x 3-ø8	359,50
EC175C-1018	1/8" x 3-ø10	181,25
EC175C-1014	1/4" x 3-ø10	235,00
EC175C-1038	3/8" x 3-ø10	296,75
EC175C-1012	1/2" x 3-ø10	370,00
EC175C-1214	1/4" x 3-ø12	253,75
EC175C-1238	3/8" x 3-ø12	315,75
EC175C-1212	1/2" x 3-ø12	390,25

Fordeler nippel/push-in
PBT / MESSING - BSPT



Varenr.	BSPT x dim	DKK
EC176K-0418	1/8" x 2-2-ø4	126,75
EC176K-0414	1/4" x 2-2-ø4	158,25
EC176K-0438	3/8" x 2-2-ø4	162,00
EC176K-0412	1/2" x 2-2-ø4	254,75
EC176K-0618	1/8" x 2-2-ø6	133,00
EC176K-0614	1/4" x 2-2-ø6	164,50
EC176K-0638	3/8" x 2-2-ø6	208,75
EC176K-0612	1/2" x 2-2-ø6	260,50
EC176K-0818	1/8" x 2-2-ø8	140,50
EC176K-0814	1/4" x 2-2-ø8	171,50
EC176K-0838	3/8" x 2-2-ø8	215,75
EC176K-0812	1/2" x 2-2-ø8	268,00
EC176K-1018	1/8" x 2-2-ø10	154,50
EC176K-1014	1/4" x 2-2-ø10	185,75
EC176K-1038	3/8" x 2-2-ø10	229,50
EC176K-1012	1/2" x 2-2-ø10	281,75
EC176K-1214	1/4" x 2-2-ø12	207,75
EC176K-1238	3/8" x 2-2-ø12	251,50
EC176K-1212	1/2" x 2-2-ø12	304,75

Fordeler nippel/push-in
PBT / MESSING - BSPP



Varenr.	BSPP × dim	DKK
EC177C-0418	1/8" × 2-2-ø4	126,75
EC177C-0414	1/4" × 2-2-ø4	158,25
EC177C-0438	3/8" × 2-2-ø4	162,00
EC177C-0412	1/2" × 2-2-ø4	254,75
EC177C-0618	1/8" × 2-2-ø6	133,00
EC177C-0614	1/4" × 2-2-ø6	164,50
EC177C-0638	3/8" × 2-2-ø6	204,75
EC177C-0612	1/2" × 2-2-ø6	260,50
EC177C-0818	1/8" × 2-2-ø8	140,50
EC177C-0814	1/4" × 2-2-ø8	171,50
EC177C-0838	3/8" × 2-2-ø8	215,75
EC177C-0812	1/2" × 2-2-ø8	268,00
EC177C-1018	1/8" × 2-2-ø10	154,50
EC177C-1014	1/4" × 2-2-ø10	185,75
EC177C-1038	3/8" × 2-2-ø10	229,50
EC177C-1012	1/2" × 2-2-ø10	281,75
EC177C-1214	1/4" × 2-2-ø12	207,75
EC177C-1238	3/8" × 2-2-ø12	251,50
EC177C-1212	1/2" × 2-2-ø12	304,75

Fordeler nippel/push-in
PBT / MESSING - BSPT



Varenr.	BSPT × dim	DKK
EC178K-0418	1/8" × 2-3-ø4	169,00
EC178K-0414	1/4" × 2-3-ø4	218,25
EC178K-0438	3/8" × 2-3-ø4	275,00
EC178K-0412	1/2" × 2-3-ø4	340,75
EC178K-0618	1/8" × 2-3-ø6	178,50
EC178K-0614	1/4" × 2-3-ø6	227,50
EC178K-0638	3/8" × 2-3-ø6	284,25
EC178K-0612	1/2" × 2-3-ø6	350,00
EC178K-0818	1/8" × 2-3-ø8	189,75
EC178K-0814	1/4" × 2-3-ø8	239,25
EC178K-0838	3/8" × 2-3-ø8	295,50
EC178K-0812	1/2" × 2-3-ø8	361,25
EC178K-1018	1/8" × 2-3-ø10	209,75
EC178K-1014	1/4" × 2-3-ø10	259,25
EC178K-1038	3/8" × 2-3-ø10	315,75
EC178K-1012	1/2" × 2-3-ø10	376,25
EC178K-1214	1/4" × 2-3-ø12	293,00
EC178K-1238	3/8" × 2-3-ø12	349,00
EC178K-1212	1/2" × 2-3-ø12	415,50

Fordeler nippel/push-in
PBT / MESSING - BSPP



Varenr.	BSPP × dim	DKK
EC179C-0418	1/8" × 2-3-ø4	169,00
EC179C-0414	1/4" × 2-3-ø4	218,25
EC179C-0438	3/8" × 2-3-ø4	275,00
EC179C-0412	1/2" × 2-3-ø4	340,75
EC179C-0618	1/8" × 2-3-ø6	178,50
EC179C-0614	1/4" × 2-3-ø6	227,50
EC179C-0638	3/8" × 2-3-ø6	284,25
EC179C-0612	1/2" × 2-3-ø6	350,00
EC179C-0818	1/8" × 2-3-ø8	189,75
EC179C-0814	1/4" × 2-3-ø8	239,25
EC179C-0838	3/8" × 2-3-ø8	295,50
EC179C-0812	1/2" × 2-3-ø8	361,25
EC179C-1018	1/8" × 2-3-ø10	209,75
EC179C-1014	1/4" × 2-3-ø10	259,25
EC179C-1038	3/8" × 2-3-ø10	315,75
EC179C-1012	1/2" × 2-3-ø10	376,25
EC179C-1214	1/4" × 2-3-ø12	293,00
EC179C-1238	3/8" × 2-3-ø12	349,00
EC179C-1212	1/2" × 2-3-ø12	415,50

Fordeler nippel/push-in
PBT / MESSING - BSPT



Varenr.	BSPT × dim	DKK
EC143K-0618	1/8" × 2-ø6	59,50
EC143K-0814	1/4" × 2-ø8	77,55
EC143K-1014	1/4" × 2-ø10	91,75
EC143K-1038	3/8" × 2-ø10	105,25
EC143K-1212	1/2" × 2-ø12	133,00
EC143K-1238	3/8" × 2-ø12	116,25

Fordeler nippel/push-in

PBT / MESSING - BSPP



Varenr.	BSPP × dim	DKK
EC143C-04M5	M5 × 2-ø4	62,00
EC143C-0618	1/8" × 2-ø6	59,50
EC143C-0814	1/4" × 2-ø8	77,55
EC143C-1014	1/4" × 2-ø10	91,75
EC143C-1038	3/8" × 2-ø10	105,25
EC143C-1238	3/8" × 2-ø12	116,25
EC143C-1212	1/2" × 2-ø12	133,00

Fordeler nippel/push-in

PBT / MESSING - BSPT



Varenr.	BSPT × dim	DKK
EC141K-0418	1/8" × 4-ø4	108,00
EC141K-0414	1/4" × 4-ø4	135,50
EC141K-0438	3/8" × 4-ø4	173,00
EC141K-0412	1/2" × 4-ø4	217,25
EC141K-0618	1/8" × 4-ø6	113,50
EC141K-0614	1/4" × 4-ø6	140,50
EC141K-0638	3/8" × 4-ø6	178,50
EC141K-0612	1/2" × 4-ø6	222,50
EC141K-0818	1/8" × 4-ø8	119,25
EC141K-0814	1/4" × 4-ø8	146,50
EC141K-0838	3/8" × 4-ø8	184,75
EC141K-0812	1/2" × 4-ø8	228,50
EC141K-1018	1/8" × 4-ø10	158,25
EC141K-1014	1/4" × 4-ø10	158,25
EC141K-1038	3/8" × 4-ø10	196,00
EC141K-1012	1/2" × 4-ø10	241,75
EC141K-1214	1/4" × 4-ø12	177,00
EC141K-1238	3/8" × 4-ø12	213,50
EC141K-1212	1/2" × 4-ø12	260,50

Fordeler nippel/push-in

PBT / MESSING - BSPP



Varenr.	BSPP × dim	DKK
EC141C-0418	1/8" × 4-ø4	108,00
EC141C-0414	1/4" × 4-ø4	135,50
EC141C-0438	3/8" × 4-ø4	173,00
EC141C-0412	1/2" × 4-ø4	210,75
EC141C-0618	1/8" × 4-ø6	113,50
EC141C-0614	1/4" × 4-ø6	140,50
EC141C-0638	3/8" × 4-ø6	178,50
EC141C-0612	1/2" × 4-ø6	222,50
EC141C-0818	1/8" × 4-ø8	119,25
EC141C-0814	1/4" × 4-ø8	146,50
EC141C-0838	3/8" × 4-ø8	184,75
EC141C-0812	1/2" × 4-ø8	228,50
EC141C-1018	1/8" × 4-ø10	158,25
EC141C-1014	1/4" × 4-ø10	158,25
EC141C-1038	3/8" × 4-ø10	196,00
EC141C-1012	1/2" × 4-ø10	241,75
EC141C-1214	1/4" × 4-ø12	177,00
EC141C-1238	3/8" × 4-ø12	213,50
EC141C-1212	1/2" × 4-ø12	260,50

Fordeler nip/muf/push-in

PBT / MESSING - BSPT



Varenr.	BSPT × dim × BSPT	DKK
EC140K-0618	1/8" × 2-ø6 × 1/8"	71,25
EC140K-1014	1/4" × 2-ø10 × 1/4"	109,25
EC140K-1038	3/8" × 2-ø10 × 3/8"	121,50
EC140K-1238	3/8" × 2-ø12 × 3/8"	133,00
EC140K-1212	1/2" × 2-ø12 × 1/2"	147,75

Fordeler nip/muf/push-in

PBT / MESSING - BSPT × BSPP



Varenr.	BSPP × dim × BSPT	DKK
EC140C-04M5	M5 × 2-ø4 × M5	64,20
EC140C-0618	1/8" × 2-ø6 × 1/8"	71,25
EC140C-0814	1/4" × 2-ø8 × 1/4"	89,00
EC140C-1014	1/4" × 2-ø10 × 1/4"	109,25
EC140C-1038	3/8" × 2-ø10 × 3/8"	121,50
EC140C-1238	3/8" × 2-ø12 × 3/8"	133,00
EC140C-1212	1/2" × 2-ø12 × 1/2"	147,75

Fordeler nippel svivel/push-in

PBT / MESSING - BSPT



Varenr.	dim × BSPT	DKK
EC116K-060418	ø6 × 3-ø4 × 1/8"	113,25
EC116K-080418	ø8 × 3-ø4 × 1/8"	113,25
EC116K-080414	ø8 × 3-ø4 × 1/4"	122,00
EC116K-080618	ø8 × 3-ø6 × 1/8"	122,25
EC116K-080614	ø8 × 3-ø6 × 1/4"	132,00
EC116K-100614	ø10 × 3-ø6 × 1/4"	126,75
EC116K-100638	ø10 × 3-ø6 × 3/8"	128,75
EC116K-100814	ø10 × 3-ø8 × 1/4"	128,75
EC116K-100838	ø10 × 3-ø8 × 3/8"	139,25

Fordeler nippel/push-in

PBT / MESSING - BSPT



Varenr.	BSPT × dim	DKK
EC142K-0418	1/8" × 6-ø4	144,00
EC142K-0414	1/4" × 6-ø4	186,75
EC142K-0438	3/8" × 6-ø4	235,00
EC142K-0412	1/2" × 6-ø4	291,75
EC142K-0618	1/8" × 6-ø6	151,50
EC142K-0614	1/4" × 6-ø6	194,50
EC142K-0638	3/8" × 6-ø6	242,75
EC142K-0612	1/2" × 6-ø6	299,00
EC142K-0818	1/8" × 6-ø8	162,00
EC142K-0814	1/4" × 6-ø8	203,50
EC142K-0838	3/8" × 6-ø8	252,75
EC142K-0812	1/2" × 6-ø8	308,00
EC142K-1018	1/8" × 6-ø10	221,25
EC142K-1014	1/4" × 6-ø10	221,25
EC142K-1038	3/8" × 6-ø10	269,00
EC142K-1012	1/2" × 6-ø10	326,50
EC142K-1214	1/4" × 6-ø12	250,00
EC142K-1238	3/8" × 6-ø12	297,75
EC142K-1212	1/2" × 6-ø12	355,00

Fordeler nippel/push-in

PBT / MESSING - BSPP



Varenr.	BSPP × dim	DKK
EC142C-0418	1/8" × 6-ø4	144,00
EC142C-0414	1/4" × 6-ø4	186,75
EC142C-0438	3/8" × 6-ø4	235,00
EC142C-0412	1/2" × 6-ø4	291,75
EC142C-0618	1/8" × 6-ø6	151,50
EC142C-0614	1/4" × 6-ø6	194,50
EC142C-0638	3/8" × 6-ø6	242,75
EC142C-0612	1/2" × 6-ø6	299,00
EC142C-0818	1/8" × 6-ø8	162,00
EC142C-0814	1/4" × 6-ø8	203,50
EC142C-0838	3/8" × 6-ø8	252,75
EC142C-0812	1/2" × 6-ø8	308,00
EC142C-1018	1/8" × 6-ø10	221,25
EC142C-1014	1/4" × 6-ø10	221,25
EC142C-1038	3/8" × 6-ø10	269,00
EC142C-1012	1/2" × 6-ø10	326,50
EC142C-1214	1/4" × 6-ø12	250,00
EC142C-1238	3/8" × 6-ø12	297,75
EC142C-1212	1/2" × 6-ø12	355,00

Fordeler push-in/rørende

PBT / MESSING



Varenr.	dim	DKK
EC117-0604	Ø6 × 3-ø4 × ø6	108,25
EC117-0804	Ø8 × 3-ø4 × ø8	113,25
EC117-0806	Ø8 × 3-ø6 × ø8	117,25
EC117-1006	Ø10 × 3-ø6 × ø10	109,75
EC117-1008	Ø10 × 3-ø8 × ø10	132,00

Fordeler nippel svivel/push-in

PBT / MESSING - BSPP



Varenr.	dim × BSPP	DKK
EC116C-060418	ø6 × 3-ø4 × 1/8"	113,25
EC116C-080418	ø8 × 3-ø4 × 1/8"	113,25
EC116C-080414	ø8 × 3-ø4 × 1/4"	122,00
EC116C-080618	ø8 × 3-ø6 × 1/8"	122,25
EC116C-080614	ø8 × 3-ø6 × 1/4"	132,00
EC116C-100614	ø10 × 3-ø6 × 1/4"	126,75
EC116C-100638	ø10 × 3-ø6 × 3/8"	128,75
EC116C-100814	ø10 × 3-ø8 × 1/4"	128,75
EC116C-100838	ø10 × 3-ø8 × 3/8"	139,25

Fordeler push-in

PBT / MESSING



Varenr.	dim	DKK
EC115-0604	2-ø6 × 3-ø4	108,25
EC115-0804	2-ø8 × 3-ø4	113,25
EC115-0806	2-ø8 × 3-ø6	117,25
EC115-1006	2-ø10 × 3-ø6	126,50
EC115-1008	2-ø10 × 3-ø8	132,00

Fordeler push-in

PBT / MESSING



Varenr.	dim	DKK
EC139-0804	Ø8 × 2-ø4 × 6	93,75
EC139-1006	Ø10 × 2-ø6 × 6	100,50
EC139-1008	Ø10 × 2-ø8 × 6	104,50
EC139-1208	Ø12 × 2-ø8 × 6	108,50

Nippel m. manometer



Varenr.	NPT	MPa	DKK
EC139K-18	1/8"	0-0,8	71,80 α

α = så længe lager haves

Skotgennemføring push-in/manometer



Varenr.	\emptyset	MPa	Ext. dim.	DKK
EC135-06	6	0-0,8	M14*1	122,00

Vinkel 90° nip/manometer

BSPT



Varenr.	NPT	MPa	DKK
EC133C-06M5	M5	0-0,8	33,10 α
EC133K-0618	1/8"	0-0,8	33,10 α
EC133K-0614	1/4"	0-0,8	33,10 α

α = så længe lager haves

T-stk push-in/manometer



Varenr.	\emptyset	MPa	DKK
EC134-06	6	0-0,8	108,25

Reduktion push-in/rørende

PBT / MESSING



Varenr.	$\emptyset \times \emptyset$	DKK
EC96-0604	6 \times 4	12,95
EC96-0804	8 \times 4	12,95
EC96-0806	8 \times 6	14,85
EC96-1006	10 \times 6	14,85
EC96-1008	10 \times 8	16,45
EC96-1206	12 \times 6	17,65
EC96-1208	12 \times 8	18,65
EC96-1210	12 \times 10	19,30

Rørstykke push-in

PBT

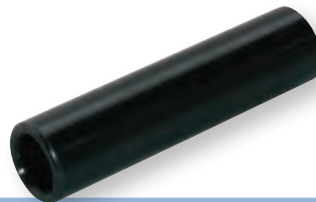

Varenr.	\emptyset	DKK
EC106-04	4	4,90
EC106-06	6	6,10
EC106-08	8	7,00
EC106-10	10	7,90
EC106-12	12	9,80
EC106-16	16	16,20

Rørstykke push-in red.

PBT



Varenr.	\emptyset	DKK
EC106-0604	6 \times 4	6,65
EC106-0804	8 \times 4	7,75
EC106-0806	8 \times 6	7,90
EC106-1006	10 \times 6	8,75
EC106-1008	10 \times 8	9,15
EC106-1208	12 \times 8	10,80
EC106-1210	12 \times 10	11,10
EC106-1612	16 \times 12	13,65

Prop push-in

PBT



Varenr.	\emptyset	DKK
EC99-04	4	4,90
EC99-06	6	6,10
EC99-08	8	7,00
EC99-10	10	7,90
EC99-12	12	9,80
EC99-16	16	12,95

Slutmuffe push-in

PBT / MESSING



Varenr.	\emptyset	DKK
EC118-04	4	13,35
EC118-06	6	15,45
EC118-08	8	17,65
EC118-10	10	21,50
EC118-12	12	23,40
EC118-16	16	44,15

Indbyg indsats push-in

MESSING



Varenr.	\emptyset	DKK
EC129-4	4	15,45
EC129-6	6	16,75
EC129-8	8	18,10
EC129-10	10	20,55
EC129-12	12	25,55

PUSH-IN FITTINGS PLAST/MESSING MINI



Mini plast push-in fittings. Denne serie er en af de mest funktionsstabile serier af push-in fittings, fremstillet under streng kvalitetskontrol. Serien udmærker sig ved en enorm mængde forskellige tilslutningsmuligheder og varianter af fittingstyper. Mini serien er designet til små indbygningsmål og med et godt luftflow gennem systemet.

Bemærk at der altid medfølger O-ring til denne type fittings, når de er udstyret med BSPP udv. gevind.

NB! kan have sorte eller blå kraver.



Push-in har en ring med bagudrettede tænder, der griber ind i slangen og hindrer, at man kan trække slangen ud. Udløseringen presser tænderne væk fra slangen, der så kan tages ud af fittingen. Selve tætningen er en O-ring, placeret lige under de tænder, der fastholder slangen i fittingen. O-ringstype se teknisk beskrivelse.

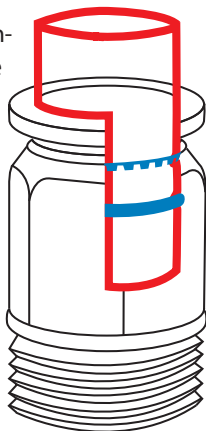

MINI nippel push-in

MESSING - BSPP



Varenr.	ø × BSPP	DKK
ECM81C-03M3	3 × M3	33,90
ECM81C-03M5	3 × M5	35,35
ECM81C-03M6	3 × M6	35,35
ECM81C-04M3	4 × M3	32,85
ECM81C-04M5	4 × M5	32,85
ECM81C-04M6	4 × M6	36,20
ECM81C-0418	4 × 1/8"	32,00
ECM81C-06M5	6 × M5	39,75
ECM81C-06M6	6 × M6	39,75
ECM81C-0618	6 × 1/8"	33,90

MINI union push-in

PBT / MESSING



Varenr.	ø	DKK
ECM97-03	3	31,20
ECM97-04	4	32,30
ECM97-0403	4 × 3	33,10
ECM97-06	6	35,35
ECM97-0604	6 × 4	36,70

MINI vinkel 90° push-in

PBT / MESSING



Varenr.	ø	DKK
ECM88-03	3	31,20
ECM88-04	4	32,30
ECM88-06	6	35,35

MINI nippel rund push-in

MESSING - BSPT



Varenr.	ø × BSPT	DKK
ECM80RK-0418	4 × 1/8"	44,15
ECM80RK-0618	6 × 1/8"	47,45

MINI muffe push-in

MESSING - BSPP



Varenr.	ø × BSPP	DKK
ECM82C-03M3	3 × M3	50,75
ECM82C-03M5	3 × M5	53,30
ECM82C-04M3	4 × M3	49,35
ECM82C-04M5	4 × M5	49,35

MINI vinkel 90° push-in/nip svivel

PBT / MESSING - BSPT



Varenr.	ø × BSPT	DKK
ECM84K-0418	4 × 1/8"	40,25
ECM84K-0618	6 × 1/8"	45,25

MINI vinkel 90° push-in/nip svivel

PBT / MESSING - BSPP



Varenr.	ø × BSPP	DKK
ECM84C-03M3	3 × M3	54,60
ECM84C-03M5	3 × M5	54,60
ECM84C-03M6	3 × M6	54,60
ECM84C-04M3	4 × M3	54,60
ECM84C-04M5	4 × M5	54,60
ECM84C-04M6	4 × M6	54,85
ECM84C-0418	4 × 1/8"	40,25
ECM84C-06M5	6 × M5	56,25
ECM84C-06M6	6 × M6	56,50
ECM84C-0618	6 × 1/8"	45,25

MINI T-stk push-in/nip svivel

PBT / MESSING - BSPP



Varenr.	ø × BSPP × ø	DKK
ECM89C-03M3	3 × M3 × 3	66,10
ECM89C-03M5	3 × M5 × 3	66,10
ECM89C-03M6	3 × M6 × 3	66,10
ECM89C-04M3	4 × M3 × 4	66,60
ECM89C-04M5	4 × M5 × 4	66,60
ECM89C-04M6	4 × M6 × 4	67,20
ECM89C-0418	4 × 1/8" × 4	56,85
ECM89C-06M5	6 × M5 × 6	69,65
ECM89C-06M6	6 × M6 × 6	69,90
ECM89C-0618	6 × 1/8" × 6	58,45

MINI Y-stykke push-in

PBT / MESSING



Varenr.	ø	DKK
ECM111-03	3	25,30
ECM111-04	4	30,10
ECM111-06	6	32,00

MINI Y-reduktion push-in

PBT / MESSING



Varenr.	dim	DKK
ECM111-0403	ø4 × 2-ø3	24,70
ECM111-0603	ø6 × 2-ø3	32,85
ECM111-0604	ø6 × 2-ø4	34,50

MINI vinkel 90° push-in/nip svivel

PBT / MESSING - BSPP



Varenr.	ø × BSPP	DKK
ECM182C-03M3	3 × M3	60,05
ECM182C-03M5	3 × M5	60,05
ECM182C-03M6	3 × M6	60,05
ECM182C-04M3	4 × M3	61,45
ECM182C-04M5	4 × M5	61,45
ECM182C-04M6	4 × M6	61,45
ECM182C-0418	4 × 1/8"	61,45
ECM182C-06M5	6 × M5	61,45
ECM182C-06M6	6 × M6	61,45
ECM182C-0618	6 × 1/8"	61,45

MINI T-stk push-in/nip svivel

PBT / MESSING - BSPP



Varenr.	BSPP × ø × ø	DKK
ECM92C-03M3	M3 × 3 × 3	66,10
ECM92C-03M5	M5 × 3 × 3	66,10
ECM92C-03M6	M6 × 3 × 3	66,10
ECM92C-04M3	M3 × 4 × 4	66,60
ECM92C-04M5	M5 × 4 × 4	66,60
ECM92C-04M6	M6 × 4 × 4	67,20
ECM92C-0418	1/8" × 4 × 4	56,85
ECM92C-06M5	M5 × 6 × 6	69,65
ECM92C-06M6	M6 × 6 × 6	69,90
ECM92C-0618	1/8" × 6 × 6	58,45

MINI reduktion push-in/rørende

PBT / MESSING



Varenr.	Ø × ø	DKK
ECM96-0403	4 × 3	24,70
ECM96-0603	6 × 3	26,90
ECM96-0604	6 × 4	27,90

MINI T-stk push-in

PBT / MESSING



Varenr.	ø	DKK
ECM94-03	3	51,00
ECM94-04	4	52,70
ECM94-06	6	58,45

MINI skotgennemføring push-in

MESSING



Varenr.	ø	Ext. dim	DKK
ECM145-03	3	M8*0,75	49,35
ECM145-04	4	M10*1	52,45
ECM145-06	6	M12*1	58,75

DRØVLEVENTILER TIL PUSH-IN



Meget kompakt udgave, til nøjagtig regulering af et optimal luftflow og styring af bevægelseskontrol af komponenter.

Bemærk at der altid medfølger O-ring til denne type ventiler, når de er udstyret med BSPP udv. gevind.

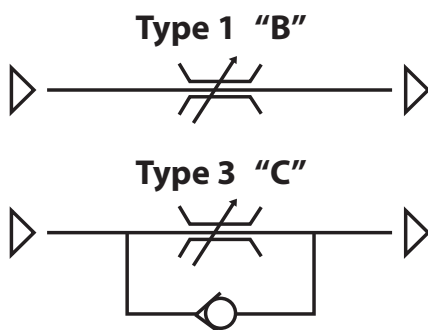

Drøvleventil man. push-in/nip PBT / MESSING - BSPT



Varenr.	ø × BSPT	Type	DKK
EC120K-0418	4 × 1/8"	3 - C	116,75
EC120K-0414	4 × 1/4"	3 - C	122,25
EC120K-0618	6 × 1/8"	3 - C	117,25
EC120K-0614	6 × 1/4"	3 - C	122,00
EC120K-0612	6 × 1/2"	3 - C	117,00
EC120K-0638	6 × 3/8"	3 - C	151,50
EC120K-0818	8 × 1/8"	3 - C	126,00
EC120K-0814	8 × 1/4"	3 - C	126,25
EC120K-0838	8 × 3/8"	3 - C	151,50
EC120K-0812	8 × 1/2"	3 - C	189,75
EC120K-1018	10 × 1/8"	3 - C	145,75
EC120K-1014	10 × 1/4"	3 - C	157,25
EC120K-1038	10 × 3/8"	3 - C	157,25
EC120K-1012	10 × 1/2"	3 - C	226,25
EC120K-1214	12 × 1/4"	3 - C	227,50
EC120K-1238	12 × 3/8"	3 - C	227,50
EC120K-1212	12 × 1/2"	3 - C	228,50

Drøvleventil man. push-in/nip PBT / MESSING - BSPP



Varenr.	ø × BSPP	Type	DKK
EC120C-03M5	3 × M5	3 - C	78,10
EC120C-04M5	4 × M5	3 - C	102,00
EC120C-0418	4 × 1/8"	3 - C	116,75
EC120C-0414	4 × 1/4"	3 - C	122,25
EC120C-06M5	6 × M5	3 - C	80,85
EC120C-0618	6 × 1/8"	3 - C	117,25
EC120C-0614	6 × 1/4"	3 - C	122,00
EC120C-0638	6 × 3/8"	3 - C	151,50
EC120C-0612	6 × 1/2"	3 - C	117,00
EC120C-0818	8 × 1/8"	3 - C	126,00
EC120C-0814	8 × 1/4"	3 - C	126,25
EC120C-0838	8 × 3/8"	3 - C	151,50
EC120C-0812	8 × 1/2"	3 - C	189,75
EC120C-1018	10 × 1/8"	3 - C	145,75
EC120C-1014	10 × 1/4"	3 - C	157,25
EC120C-1038	10 × 3/8"	3 - C	157,25
EC120C-1012	10 × 1/2"	3 - C	226,25
EC120C-1214	12 × 1/4"	3 - C	227,50
EC120C-1238	12 × 3/8"	3 - C	227,50
EC120C-1212	12 × 1/2"	3 - C	228,50

Push-in har en ring med bagudrettede tænder, der griber ind i slangen og hindrer, at man kan trække slangen ud. Udløseringen presser tænderne væk fra slangen, der så kan tages ud af fittingen.

Selve tætningen er en O-ring, placeret lige under de tænder, der fastholder slangen i fittingen. O-ringstype se teknisk beskrivelse.

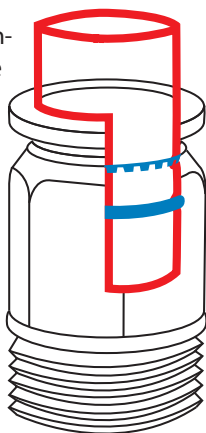

Flowregulator push-in PBT / MESSING



Varenr.	ø	Type	DKK
EC121-04	4	1 - B	127,50
EC121-06	6	1 - B	146,50
EC121-08	8	1 - B	168,00
EC121-10	10	1 - B	186,75
EC121-12	12	1 - B	209,75

Flowreg. med kontra push-in/ muffe/nippel

PBT / MESSING - BSPT×BSPP



Varenr.	BSPT × ø × BSPP	DKK
EC193-0618	1/8" × 6 × M5	326,50
EC193-0614	1/4" × 6 × 1/8"	326,50
EC193-0818	1/8" × 8 × M5	326,50
EC193-0814	1/4" × 8 × 1/8"	386,75
EC193-0838	3/8" × 8 × 1/8"	458,50
EC193-1038	3/8" × 10 × 1/8"	458,50
EC193-1012	1/2" × 10 × 1/4"	605,75
EC193-1238	3/8" × 12 × 1/8"	458,50
EC193-1212	1/2" × 12 × 1/4"	605,75

Drøvleventil skruve push-in/nip

PBT / MESSING - BSPP



Varenr.	ø × BSPP	Type	DKK
EC191C-03M5	3 × M5	3 - C	78,10
EC191C-04M5	4 × M5	3 - C	81,10
EC191C-0418	4 × 1/8"	3 - C	74,55
EC191C-0414	4 × 1/4"	3 - C	77,85
EC191C-06M5	6 × M5	3 - C	81,10
EC191C-0618	6 × 1/8"	3 - C	75,10
EC191C-0614	6 × 1/4"	3 - C	77,85
EC191C-0638	6 × 3/8"	3 - C	97,20
EC191C-0818	8 × 1/8"	3 - C	80,55
EC191C-0814	8 × 1/4"	3 - C	80,55
EC191C-0838	8 × 3/8"	3 - C	96,95
EC191C-0812	8 × 1/2"	3 - C	115,25
EC191C-1018	10 × 1/8"	3 - C	93,00
EC191C-1014	10 × 1/4"	3 - C	99,10
EC191C-1038	10 × 3/8"	3 - C	99,95
EC191C-1012	10 × 1/2"	3 - C	144,00
EC191C-1214	12 × 1/4"	3 - C	145,25
EC191C-1238	12 × 3/8"	3 - C	145,25
EC191C-1212	12 × 1/2"	3 - C	146,50

Drøvleventil man. push-in/nip

PBT / MESSING - BSPT



Varenr.	ø × BSPT	Type	DKK
EC192K-04M5	4 × M5	1 - B	85,20
EC192K-0418	4 × 1/8"	1 - B	97,45
EC192K-0414	4 × 1/4"	1 - B	102,50
EC192K-06M5	6 × M5	1 - B	85,45
EC192K-0618	6 × 1/8"	1 - B	98,55
EC192K-0614	6 × 1/4"	1 - B	102,50
EC192K-0638	6 × 3/8"	1 - B	127,50
EC192K-0818	8 × 1/8"	1 - B	105,50
EC192K-0814	8 × 1/4"	1 - B	105,50
EC192K-0838	8 × 3/8"	1 - B	127,50
EC192K-0812	8 × 1/2"	1 - B	151,50
EC192K-1014	10 × 1/4"	1 - B	132,00
EC192K-1038	10 × 3/8"	1 - B	132,00
EC192K-1012	10 × 1/2"	1 - B	189,75
EC192K-1214	12 × 1/4"	1 - B	190,75
EC192K-1238	12 × 3/8"	1 - B	190,75
EC192K-1212	12 × 1/2"	1 - B	191,75

Drøvleventil skruve push-in/nip

PBT / MESSING - BSPT



Varenr.	ø × BSPT	Type	DKK
EC190K-0418	4 × 1/8"	3 - C	74,55
EC190K-0414	4 × 1/4"	3 - C	77,85
EC190K-0618	6 × 1/8"	3 - C	75,10
EC190K-0614	6 × 1/4"	3 - C	77,85
EC190K-0638	6 × 3/8"	3 - C	97,20
EC190K-0612	6 × 1/2"	3 - C	95,05
EC190K-0818	8 × 1/8"	3 - C	80,55
EC190K-0814	8 × 1/4"	3 - C	80,55
EC190K-0838	8 × 3/8"	3 - C	96,95
EC190K-0812	8 × 1/2"	3 - C	115,25
EC190K-1018	10 × 1/8"	3 - C	94,25
EC190K-1014	10 × 1/4"	3 - C	99,95
EC190K-1038	10 × 3/8"	3 - C	99,95
EC190K-1012	10 × 1/2"	3 - C	144,00
EC190K-1214	12 × 1/4"	3 - C	145,25
EC190K-1238	12 × 3/8"	3 - C	145,25
EC190K-1212	12 × 1/2"	3 - C	146,50

Type 1 "B"



Type 3 "C"

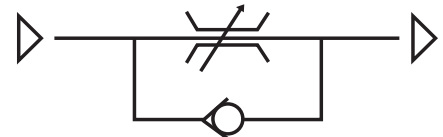

Drøvleventil man. push-in/nip

PBT / MESSING - BSPT



Denne type drøvleventil er med trykknop for frigivelse af resttryk.

Giver præcis regulering af luftmængden til nøjagtig styring af en cylinder.

Konstant hastighedskontrol.

Varenr.	ø × BSPT	DKK
EC194K-0418	4×1/8"	122,00
EC194K-0414	4×1/4"	135,25
EC194K-0618	6×1/8"	123,00
EC194K-0638	6×3/8"	160,00
EC194K-0614	6×1/4"	135,25
EC194K-0612	6×1/2"	183,75
EC194K-0818	8×1/8"	128,50
EC194K-0814	8×1/4"	137,75
EC194K-0838	8×3/8"	160,00
EC194K-0812	8×1/2"	189,75
EC194K-1018	10×1/8"	124,50
EC194K-1014	10×1/4"	158,50
EC194K-1038	10×3/8"	163,00
EC194K-1012	10×1/2"	220,75
EC194K-1214	12×1/4"	207,50
EC194K-1238	12×3/8"	212,25
EC194K-1212	12×1/2"	222,75

Drøvleventil man. push-in/nip

PBT / MESSING - BSPP



Denne type drøvleventil er med trykknop for frigivelse af resttryk.

Giver præcis regulering af luftmængden til nøjagtig styring af en cylinder.

Konstant hastighedskontrol.

Varenr.	ø × BSPP	DKK
EC194C-0418	4×1/8"	122,00
EC194C-0414	4×1/4"	135,25
EC194C-0618	6×1/8"	123,00
EC194C-0614	6×1/4"	135,25
EC194C-0638	6×3/8"	160,00
EC194C-0612	6×1/2"	183,75
EC194C-0818	8×1/8"	128,50
EC194C-0814	8×1/4"	137,75
EC194C-0838	8×3/8"	160,00
EC194C-0812	8×1/2"	189,75
EC194C-1018	10×1/8"	124,50
EC194C-1014	10×1/4"	158,50
EC194C-1038	10×3/8"	163,00
EC194C-1012	10×1/2"	220,75
EC194C-1214	12×1/4"	207,50
EC194C-1238	12×3/8"	212,25
EC194C-1212	12×1/2"	222,75

SPECIELLE FUNKTIONER

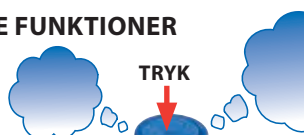

- Drøvleventil med hurtig udluftning
- Sikrer konstant tryk og kan trykudligne blot ved at trykke på knappen
- Gør vedligehold og inspektion såre simpelt
- Nøjagtig regulering af lufttrykket for præcis bevægelseskontrol
- Konstant hastighedsstyring

VENTILER TIL PUSH-IN



Max 10 bar



0°C til +60°C



Ventil til at afbryde luftstrøm ved simpel drejning af håndtag. Måden, ventilen er opbygget på, sikrer at trykket på aftapningssiden automatisk udløses, når man lukker for ventilen, så systemet efter ventilen er trykløst. Ideel til inspektion eller reparation af komponenter uden at gå på kompromis med sikkerheden.

Bemærk at der altid medfølger O-ring til denne type ventiler, når de er udstyret med BSPP udv. gevind.

Push-in har en ring med bagudrettede tænder, der griber ind i slangen og hindrer, at man kan trække slangen ud. Udløseringen presser tænderne væk fra slangen, der så kan tages ud af fittingen.

Selve tætningen er en O-ring, placeret lige under de tænder, der fastholder slangen i fittingen. O-ringstype se teknisk beskrivelse.

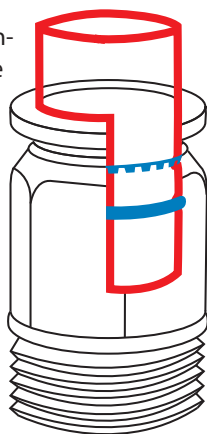

Ventil push-in/nippel

PBT / MESSING - BSPT



Varenr.	ø × BSPT	DKK
EC122K-0618	6 × 1/8"	65,95
EC122K-0614	6 × 1/4"	65,55
EC122K-0638	6 × 3/8"	67,75
EC122K-0818	8 × 1/8"	67,75
EC122K-0814	8 × 1/4"	69,90
EC122K-0838	8 × 3/8"	72,65
EC122K-1014	10 × 1/4"	72,65
EC122K-1038	10 × 3/8"	75,10
EC122K-1012	10 × 1/2"	77,55
EC122K-1214	12 × 1/4"	77,55
EC122K-1238	12 × 3/8"	80,00
EC122K-1212	12 × 1/2"	82,15

Ventil push-in/nippel

PBT / MESSING - BSPP



Varenr.	ø × BSPP	DKK
EC122C-0618	6 × 1/8"	78,90
EC122C-0614	6 × 1/4"	81,90
EC122C-0638	6 × 3/8"	84,65
EC122C-0818	8 × 1/8"	84,65
EC122C-0814	8 × 1/4"	87,35
EC122C-0838	8 × 3/8"	90,90
EC122C-1014	10 × 1/4"	90,90
EC122C-1038	10 × 3/8"	93,65
EC122C-1012	10 × 1/2"	97,20
EC122C-1214	12 × 1/4"	97,20
EC122C-1238	12 × 3/8"	99,95
EC122C-1212	12 × 1/2"	102,75

Ventil nippel/push-in

PBT / MESSING - BSPT



Varenr.	∅ × BSPT	DKK
EC123K-0618	6 × 1/8"	62,80
EC123K-0614	6 × 1/4"	67,75
EC123K-0638	6 × 3/8"	72,65
EC123K-0818	8 × 1/8"	65,55
EC123K-0814	8 × 1/4"	67,75
EC123K-0838	8 × 3/8"	75,10
EC123K-1014	10 × 1/4"	69,90
EC123K-1038	10 × 3/8"	77,55
EC123K-1012	10 × 1/2"	80,00
EC123K-1214	12 × 1/4"	77,55
EC123K-1238	12 × 3/8"	91,50
EC123K-1212	12 × 1/2"	109,25

Ventil nippel/push-in

PBT / MESSING - BSPP



Varenr.	∅ × BSPP	DKK
EC123C-0618	6 × 1/8"	78,90
EC123C-0614	6 × 1/4"	84,65
EC123C-0638	6 × 3/8"	90,90
EC123C-0818	8 × 1/8"	81,90
EC123C-0814	8 × 1/4"	84,65
EC123C-0838	8 × 3/8"	93,65
EC123C-1014	10 × 1/4"	87,35
EC123C-1038	10 × 3/8"	97,20
EC123C-1012	10 × 1/2"	99,95
EC123C-1214	12 × 1/4"	97,20
EC123C-1238	12 × 3/8"	114,75
EC123C-1212	12 × 1/2"	136,50

Ventil nip/nip

PBT / MESSING - BSPT



Varenr.	BSPT	DKK
EC125K-1818	1/8"	67,75
EC125K-1418	1/4" × 1/8"	72,65
EC125K-1414	1/4"	77,55
EC125K-3814	3/8" × 1/4"	82,15
EC125K-3838	3/8"	87,10
EC125K-1238	1/2" × 3/8"	91,75
EC125K-1212	1/2"	96,65

Ventil nip/nip

PBT / MESSING - BSPP



Varenr.	BSPP	DKK
EC125C-1818	1/8"	84,65
EC125C-1418	1/4" × 1/8"	90,90
EC125C-1414	1/4"	97,20
EC125C-3814	3/8" × 1/4"	102,75
EC125C-3838	3/8"	109,25
EC125C-1238	1/2" × 3/8"	115,00
EC125C-1212	1/2"	121,25

Ventil push-in

PBT / MESSING



Varenr.	∅	DKK
EC124-0606	6	58,15
EC124-0806	8 × 6	62,80
EC124-0808	8	62,80
EC124-1008	10 × 8	67,75
EC124-1010	10	67,75
EC124-1210	12 × 10	72,65
EC124-1212	12	72,65

KONTRAVENTILER



Max 10 bar



0°C til +60°C



Kontraventil, hvor luften flyder frit i den ene retning og afspærres i modsat retning. Kan bruges ned til meget lavt modtryk.

Bemærk at der altid medfølger O-ring til denne type ventiler, når de er udstyret med BSPP udv. gevind.

Push-in har en ring med bagudrettede tænder, der griber ind i slangen og hindrer, at man kan trække slangen ud. Udløseringen presser tænderne væk fra slangen, der så kan tages ud af fittingen.

Selve tætningen er en O-ring, placeret lige under de tænder, der fastholder slangen i fittingen. O-ringstype se teknisk beskrivelse.

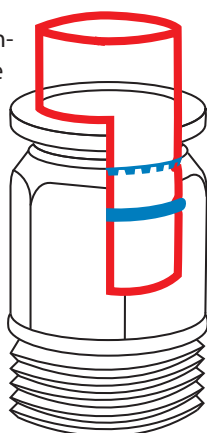

Kontraventil push-in/nip

MESSING - BSPT



Store størrelser = ALU

Varenr.	ø × BSPT	DKK
EC130K-0418	4 × 1/8"	87,65
EC130K-0618	6 × 1/8"	93,90
EC130K-0614	6 × 1/4"	98,55
EC130K-0818	8 × 1/8"	104,25
EC130K-0814	8 × 1/4"	109,75
ALU		
EC130K-1038	10 × 3/8"	230,50
EC130K-1012	10 × 1/2"	242,50
EC130K-1238	12 × 3/8"	238,50
EC130K-1212	12 × 1/2"	249,50

Åbningstryk: 0,1 - 0,2 bar

Kontraventil push-in/nip

MESSING - BSPP

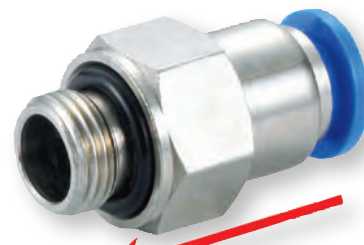

Store størrelser = ALU

Varenr.	ø × BSPP	DKK
EC130C-04M5	4 × M5	96,95
EC130C-04M6	4 × M6	96,95
EC130C-0418	4 × 1/8"	87,65
EC130C-0618	6 × 1/8"	93,90
EC130C-0614	6 × 1/4"	98,55
EC130C-0818	8 × 1/8"	104,25
EC130C-0814	8 × 1/4"	109,75
ALU		
EC130C-1038	10 × 3/8"	230,50
EC130C-1012	10 × 1/2"	242,50
EC130C-1238	12 × 3/8"	238,50
EC130C-1212	12 × 1/2"	249,50

Åbningstryk: 0,1 - 0,2 bar

Kontraventil nip/push-in

MESSING - BSPT



Store størrelser = ALU

Varenr.	ø × BSPT	DKK
EC130KA-0418	4 × 1/8"	87,65
EC130KA-0618	6 × 1/8"	93,90
EC130KA-0614	6 × 1/4"	98,55
EC130KA-0818	8 × 1/8"	104,25
EC130KA-0814	8 × 1/4"	109,75

ALU

EC130KA-1038	10 × 3/8"	230,50
EC130KA-1012	10 × 1/2"	242,50
EC130KA-1238	12 × 3/8"	236,25
EC130KA-1212	12 × 1/2"	249,50

Åbningstryk: 0,1 - 0,2 bar

Kontraventil nip/push-in

MESSING - BSPP

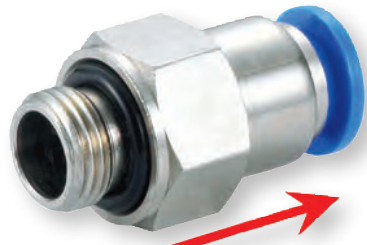

Store størrelser = ALU

Varenr.	ø × BSPP	DKK
EC130CA-04M5	4 × M5	96,95
EC130CA-04M6	4 × M6	96,95
EC130CA-0418	4 × 1/8"	87,65
EC130CA-0618	6 × 1/8"	93,90
EC130CA-0614	6 × 1/4"	98,55
EC130CA-0818	8 × 1/8"	104,25
EC130CA-0814	8 × 1/4"	109,75

ALU

EC130CA-1038	10 × 3/8"	230,50
EC130CA-1012	10 × 1/2"	242,50
EC130CA-1238	12 × 3/8"	238,50
EC130CA-1212	12 × 1/2"	249,50

Åbningstryk: 0,1 - 0,2 bar

Kontraventil muf/nip

MESSING - BSPT×BSPP



Åbningstryk: 0,1 - 0,2 bar

Varenr.	BSPT × BSPP	DKK
EC131K-01	1/8"	114,25
EC131K-02	1/4"	127,00
EC131K-03	3/8"	226,25
EC131K-04	1/2"	251,25

Kontraventil muf/nip

MESSING - BSPP



Åbningstryk: 0,1 - 0,2 bar

Varenr.	BSPP	DKK
EC131C-01	1/8"	114,25
EC131C-02	1/4"	127,00
EC131C-03	3/8"	227,75
EC131C-04	1/2"	251,25

Kontraventil nip/muf

MESSING - BSPT×BSPP



Åbningstryk: 0,1 - 0,2 bar

Varenr.	BSPT × BSPP	DKK
EC131KA-01	1/8"	114,25
EC131KA-02	1/4"	127,00
EC131KA-03	3/8"	226,25
EC131KA-04	1/2"	251,25

Kontraventil nip/muf

MESSING - BSPP



Åbningstryk: 0,1 - 0,2 bar

Varenr.	BSPP	DKK
EC131CA-01	1/8"	114,25
EC131CA-02	1/4"	127,00
EC131CA-03	3/8"	227,75
EC131CA-04	1/2"	228,25

Kontraventil push-in

PBT / MESSING EL. ALUMINIUM



Åbningstryk: 0,1 - 0,2 bar

Varenr.	ø	Messing	DKK
EC132-04	4		86,05
EC132-06	6		96,65
EC132-08	8		118,00
ALU			
EC132-10	10		265,75
EC132-12	12		280,75

STOPVENTILER



Max 10 bar



0°C til +60°C



Stopventil, hvor luftgennemstrømningen stoppes ved afmontering af slange og retableres ved push-in af slange. 2-vejs mekanisme sørger for, at dette virker fra begge sider, hvor slanger ofte afmonteres og bruges i udviklings- og testmiljøer, samt til demonstration af pneumatiske virkemåder.

Bemærk at der altid medfølger O-ring til denne type ventiler, når de er udstyret med BSPP udv. gevind.

Push-in har en ring med bagudrettede tænder, der griber ind i slangen og hindrer, at man kan trække slangen ud. Udløseringen presser tænderne væk fra slangen, der så kan tages ud af fittingen.

Selve tætningen er en O-ring, placeret lige under de tænder, der fastholder slangen i fittingen. O-ringstype se teknisk beskrivelse.

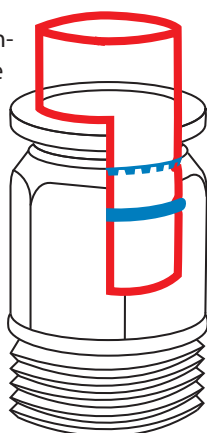

Stopventil push-in/nippel

MESSING - BSPT



Varenr.	ø × BSPT	DKK
EC126K-0418	4 × 1/8"	77,85
EC126K-0618	6 × 1/8"	78,90
EC126K-0614	6 × 1/4"	81,65
EC126K-0814	8 × 1/4"	92,00
EC126K-0838	8 × 3/8"	112,25
EC126K-1014	10 × 1/4"	112,75
EC126K-1038	10 × 3/8"	116,00
EC126K-1012	10 × 1/2"	126,50
EC126K-1214	12 × 1/4"	152,50
EC126K-1238	12 × 3/8"	134,25
EC126K-1212	12 × 1/2"	138,00

Stopventil push-in/nippel

MESSING - BSPP



Varenr.	ø × BSPP	DKK
EC126C-0418	4 × 1/8"	77,85
EC126C-0618	6 × 1/8"	78,90
EC126C-0614	6 × 1/4"	81,65
EC126C-0814	8 × 1/4"	92,00
EC126C-0838	8 × 3/8"	112,25
EC126C-1014	10 × 1/4"	112,75
EC126C-1038	10 × 3/8"	116,00
EC126C-1012	10 × 1/2"	126,50
EC126C-1214	12 × 1/4"	152,50
EC126C-1238	12 × 3/8"	134,25
EC126C-1212	12 × 1/2"	138,00

Stopventil 90° push-in/nippel

PBT / MESSING - BSPT



Varenr.	ø × BSPT	DKK
EC127K-0418	4 × 1/8"	86,55
EC127K-0618	6 × 1/8"	89,25
EC127K-0614	6 × 1/4"	93,65
EC127K-0818	8 × 1/8"	99,95
EC127K-0814	8 × 1/4"	103,50
EC127K-0838	8 × 3/8"	117,00
EC127K-1014	10 × 1/4"	132,00
EC127K-1038	10 × 3/8"	134,25
EC127K-1012	10 × 1/2"	153,00
EC127K-1238	12 × 3/8"	182,75
EC127K-1212	12 × 1/2"	187,00

Stopventil 90° push-in/nippel

PBT / MESSING - BSPP



Varenr.	ø × BSPP	DKK
EC127C-04M5	4 × M5	89,25
EC127C-04M6	4 × M6	93,65
EC127C-0418	4 × 1/8"	84,40
EC127C-06M5	6 × M5	99,95
EC127C-0618	6 × 1/8"	89,25
EC127C-0614	6 × 1/4"	93,65
EC127C-0818	8 × 1/8"	25,00 α
EC127C-0814	8 × 1/4"	103,50
EC127C-0838	8 × 3/8"	117,00
EC127C-1014	10 × 1/4"	132,00
EC127C-1038	10 × 3/8"	134,25
EC127C-1012	10 × 1/2"	153,00
EC127C-1238	12 × 3/8"	182,75
EC127C-1212	12 × 1/2"	187,00

α = så længe lager haves

Stopventil push-in

PBT / MESSING EL. ALUMINIUM



Varenr.	ø	Messing	DKK
EC128-04	4		84,40
EC128-06	6		98,85
EC128-08	8		112,75
ALU			
EC128-10	10		126,50
EC128-12	12		132,00

PUSH-IN FITTINGS MESSING



Ø4 - Ø8 = -0,99bar - 12 bar
Ø10-Ø14 = -0,99bar - 10 bar



0°C til +60°C



Messing push-in fittings. Denne serie er en af de mest funktionsstabile serier af push-in fittings, fremstillet under streng kvalitetskontrol. Serien udmærker sig ved en enorm mængde forskellige tilslutningsmuligheder og varianter af fittingstyper. Alle fittings er designet til et godt luftflow gennem systemet.

Bemærk, at der altid er pakning på denne type fittings, når de er udstyret med udv. gevind.

Push-in har en ring med bagudrettede tænder, der griber ind i slangen og hindrer, at man kan trække slangen ud. Udløseringen presser tænderne væk fra slangen, der så kan tages ud af fittingen. Selve tætningen er en O-ring, placeret lige under de tænder, der fastholder slangen i fittingen. O-ringstype se teknisk beskrivelse.

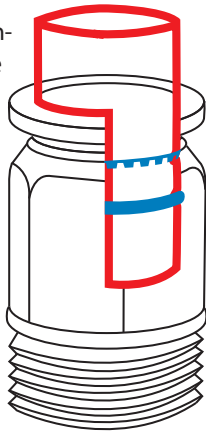

Nippel/push-in MESSING - BSPT



Varenr.	Ø × BSPT	DKK
E80-1	4 × 1/8"	18,20
E80-2	4 × 1/4"	19,45
E80-5	6 × 1/8"	18,20
E80-6	6 × 1/4"	19,45
E80-7	8 × 1/8"	19,45
E80-8	8 × 1/4"	19,45
E80-9	8 × 3/8"	30,35
E80-10	10 × 1/4"	28,95
E80-11	10 × 3/8"	30,35
E80-12	12 × 3/8"	41,10
E80-13	12 × 1/2"	44,70
E80-14	14 × 3/8"	61,70
E80-15	14 × 1/2"	69,35

Nippel/push-in MESSING - BSPP



Varenr.	Ø × dim	DKK
E81-1	4 × M5	33,65
E81-2	4 × M6	21,95
E81-3	4 × 1/8"	20,75
E81-4	4 × 1/4"	23,20
E81-5	5 × 1/8"	29,25
E81-6	5 × 1/4"	32,00
E81-7	6 × M12*1	33,65
E81-8	6 × M12*1,25	33,65
E81-9	6 × M12*1,5	33,65
E81-10	6 × 1/8"	20,75
E81-11	6 × 1/4"	23,20
E81-12	8 × 1/8"	23,20
E81-13	8 × 1/4"	24,15
E81-14	8 × 3/8"	35,05
E81-15	10 × 1/4"	31,50
E81-16	10 × 3/8"	35,35
E81-17	12 × 3/8"	44,70
E81-18	12 × 1/2"	48,30
E81-19	14 × 3/8"	84,40
E81-20	14 × 1/2"	86,80

Muffe/push-in MESSING - BSPP



Varenr.	Ø × BSPP	DKK
E82-1	4 × 1/8"	31,50
E82-4	6 × 1/8"	31,50
E82-5	6 × 1/4"	31,50
E82-6	8 × 1/8"	32,85
E82-7	8 × 1/4"	42,20
E82-8	10 × 1/4"	38,90
E82-9	10 × 3/8"	48,30

Vinkel 90° push-in

MESSING



Varenr.	∅	DKK
E88-1	4	36,20
E88-3	6	38,90
E88-4	8	42,20
E88-5	10	59,00
E88-6	12	70,15
E88-7	14	108,50

Vinkel 90° push-in/nip svivel

MESSING - BSPP



Varenr.	∅ × BSPP	DKK
E85-1	4 × M5	45,25
E85-2	4 × 1/8"	42,20
E85-3	4 × 1/4"	44,70
E85-6	6 × 1/8"	42,20
E85-7	6 × 1/4"	44,70
E85-8	8 × 1/8"	49,65
E85-9	8 × 1/4"	52,45
E85-10	10 × 1/4"	71,55
E85-11	10 × 3/8"	77,25
E85-12	12 × 3/8"	90,35
E85-13	12 × 1/2"	100,50
E85-14	14 × 3/8"	168,75
E85-15	14 × 1/2"	180,75

Banjo push-in/nippel

MESSING - BSPP



Varenr.	∅ × BSPP	DKK
E86-1	4 × M5	59,00
E86-2	4 × 1/8"	37,50
E86-3	4 × 1/4"	40,00
E86-6	6 × M12*1	52,15
E86-7	6 × M12*1,25	51,00
E86-8	6 × M12*1,5	51,00
E86-9	6 × 1/8"	37,50
E86-10	6 × 1/4"	40,00
E86-11	8 × 1/8"	44,70
E86-12	8 × 1/4"	47,20
E86-13	8 × 3/8"	70,15
E86-14	10 × 1/4"	63,90
E86-15	10 × 3/8"	68,85
E86-16	12 × 3/8"	81,10
E86-17	12 × 1/2"	89,25
E86-18	14 × 3/8"	117,00
E86-19	14 × 1/2"	129,00

Skotgennemføring 90°

MESSING

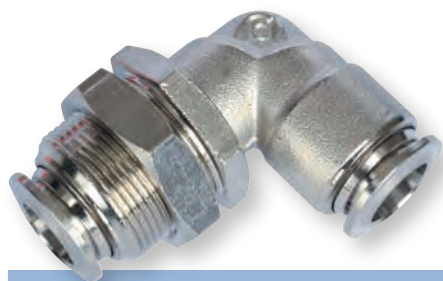

Varenr.	∅ × M	DKK
E112-1	4 × M12	53,35
E112-2	6 × M14	63,35
E112-3	8 × M16	72,90
E112-4	10 × M20	85,75
E112-5	12 × M22	95,80
E112-6	14 × M23	98,15

Vinkel 90° push-in/nip svivel

MESSING - BSPT



Varenr.	∅ × BSPT	DKK
E84-1	4 × 1/8"	33,65
E84-2	4 × 1/4"	36,20
E84-5	6 × 1/8"	33,65
E84-6	6 × 1/4"	35,85
E84-7	8 × 1/8"	40,00
E84-8	8 × 1/4"	42,20
E84-9	8 × 3/8"	48,30
E84-10	10 × 1/4"	60,35
E84-11	10 × 3/8"	63,90
E84-12	12 × 3/8"	74,30
E84-13	12 × 1/8"	83,30
E84-14	14 × 3/8"	108,50
E84-15	14 × 1/2"	120,75

Vinkel 90° push-in/muf svivel

MESSING - BSPP



Varenr.	∅ × BSPP	DKK
E87-1	4 × 1/8"	37,50
E87-4	6 × 1/8"	37,50
E87-5	6 × 1/4"	47,20
E87-6	8 × 1/8"	43,85
E87-7	8 × 1/4"	49,35
E87-8	10 × 1/4"	61,45
E87-9	10 × 3/8"	75,90

Vinkel 90° push-in/nippel

MESSING - BSPT



Varenr.	∅ × BSPT	DKK
E83-1	4 × 1/8"	25,35
E83-2	4 × 1/4"	26,60
E83-5	6 × 1/8"	26,60
E83-6	6 × 1/4"	26,60
E83-7	8 × 1/8"	30,10
E83-8	8 × 1/4"	30,10
E83-9	10 × 1/4"	48,30
E83-10	10 × 3/8"	48,30
E83-11	12 × 3/8"	60,35
E83-12	12 × 1/2"	65,55

T-stk push-in MESSING



Varenr.	∅	DKK
E94-1	4	48,30
E94-3	6	40,85
E94-4	8	59,00
E94-5	10	77,25
E94-6	12	101,75
E94-7	14	144,00

Banjo dbl push-in/nippel MESSING - BSPP



Varenr.	∅ × BSPP × ∅	DKK
E90-1	4 × 1/8" × 4	56,50
E90-2	4 × 1/4" × 4	60,35
E90-5	6 × 1/8" × 6	56,85
E90-6	6 × 1/4" × 6	71,55
E90-7	8 × 1/8" × 8	63,90
E90-8	8 × 1/4" × 8	67,75
E90-9	8 × 3/8" × 8	99,10
E90-10	10 × 1/4" × 10	93,90
E90-11	10 × 3/8" × 10	99,10
E90-12	12 × 3/8" × 12	120,75
E90-13	12 × 1/2" × 12	133,00

T-stk push-in/nippel ende MESSING - BSPT



Varenr.	BSPT × ∅ × ∅	DKK
E92-1	1/8" × 4 × 4	52,15
E92-2	1/4" × 4 × 4	55,45
E92-5	1/8" × 6 × 6	52,15
E92-6	1/4" × 6 × 6	55,45
E92-7	1/8" × 8 × 8	58,15
E92-8	1/4" × 8 × 8	61,45
E92-9	1/4" × 10 × 10	85,45
E92-10	3/8" × 10 × 10	90,35
E92-11	3/8" × 12 × 12	109,75
E92-12	1/2" × 12 × 12	120,75

T-stk push-in/nippel gren MESSING - BSPT



Varenr.	∅ × BSPT × ∅	DKK
E89-1	4 × 1/8" × 4	52,15
E89-2	4 × 1/4" × 4	55,70
E89-5	6 × 1/8" × 6	52,15
E89-6	6 × 1/4" × 6	55,45
E89-7	8 × 1/8" × 8	58,15
E89-8	8 × 1/4" × 8	61,45
E89-9	8 × 3/8" × 8	90,35
E89-10	10 × 1/4" × 10	85,45
E89-11	10 × 3/8" × 10	90,35
E89-12	12 × 3/8" × 12	111,00
E89-13	12 × 1/2" × 12	120,75

T-stk svivel push-in/nippel MESSING - BSPP



Varenr.	∅ × BSPP × ∅	DKK
E91-1	4 × M5 × 4	68,85
E91-2	4 × 1/8" × 4	64,95
E91-3	4 × 1/4" × 4	64,95
E91-6	6 × 1/8" × 6	64,95
E91-7	6 × 1/4" × 6	64,95
E91-8	8 × 1/8" × 8	77,25
E91-9	8 × 1/4" × 8	78,35
E91-10	10 × 1/4" × 10	104,00
E91-11	10 × 3/8" × 10	105,00
E91-12	12 × 3/8" × 12	133,00
E91-13	12 × 1/2" × 12	145,00
E91-14	14 × 3/8" × 14	180,75
E91-15	14 × 1/2" × 14	192,50

T-stk push-in/nippel ende MESSING - BSPP



Varenr.	∅ × ∅ × BSPP	DKK
E93-1	4 × 4 × 1/8"	59,80
E93-2	4 × 4 × 1/4"	59,80
E93-5	6 × 6 × 1/8"	56,50
E93-6	6 × 6 × 1/4"	59,80
E93-7	8 × 8 × 1/8"	63,90
E93-8	8 × 8 × 1/4"	67,75
E93-9	10 × 10 × 1/4"	93,90
E93-10	10 × 10 × 3/8"	99,10
E93-11	12 × 12 × 3/8"	120,75
E93-12	12 × 12 × 1/2"	133,00

Reduktion push-in/rørstykke

MESSING



Varenr.	Ø × ø	DKK
E96-1	5 × 4	24,15
E96-2	6 × 4	24,15
E96-3	8 × 4	24,15
E96-4	10 × 4	24,15
E96-5	12 × 4	24,15
E96-9	8 × 6	24,15
E96-10	10 × 6	24,15
E96-11	12 × 6	24,15
E96-12	10 × 8	26,05
E96-13	12 × 8	26,05
E96-14	12 × 10	27,90
E96-15	14 × 10	53,30

Push-in prop

MESSING



Varenr.	Ø	DKK
E99-1	4	7,60
E99-3	6	7,60
E99-4	8	10,45
E99-5	10	13,55
E99-6	12	16,95

Banjobolt trippel

MESSING - BSPP



Varenr.	dim	DKK
E102-1	1/8"	47,20
E102-2	1/4"	54,60
E102-3	3/8"	80,00
E102-4	1/2"	99,40

Banjobolt

MESSING - BSPP



Varenr.	BSPP	DKK
E100-1	M5	11,05
E100-2	1/8"	16,95
E100-3	1/4"	33,10
E100-4	3/8"	45,50
E100-5	1/2"	70,45

Banjonippel push-in

MESSING



Varenr.	ø × dim	DKK
E103-2	4 × M5	25,35
E103-3	4 × 1/8"	27,90
E103-6	6 × 1/8"	28,95
E103-7	6 × 1/4"	32,55
E103-8	8 × 1/8"	33,65
E103-9	8 × 1/4"	36,20
E103-10	8 × 3/8"	48,30
E103-11	10 × 1/4"	41,10
E103-12	10 × 3/8"	51,00
E103-13	12 × 3/8"	62,80
E103-14	12 × 1/2"	71,25

Union push-in

MESSING



Varenr.	ø	DKK
E97-1	4	33,65
E97-3	6	37,50
E97-4	8	42,20
E97-5	10	46,05
E97-6	12	67,75
E97-7	14	93,90

Banjobolt dobbelt

MESSING - BSPP



Varenr.	dim	DKK
E101-1	1/8"	21,95
E101-2	1/4"	31,50
E101-3	3/8"	41,10
E101-4	1/2"	68,85

Banjonippel dbl push-in

MESSING



Varenr.	ø × dim × ø	DKK
E104-2	4 × M5 × 4	52,15
E104-3	4 × 1/8" × 4	55,45
E104-6	6 × 1/8" × 6	56,50
E104-7	6 × 1/4" × 6	56,50
E104-8	8 × 1/8" × 8	61,45
E104-9	8 × 1/4" × 8	63,90
E104-10	10 × 1/4" × 10	74,80
E104-11	10 × 3/8" × 10	83,30
E104-12	12 × 3/8" × 12	100,50
E104-13	12 × 1/2" × 12	106,00

Skotgennemføring push-in

MESSING



Varenr.	ø	Ext. dim	DKK
E98-1	4	M12*1	58,15
E98-3	6	M14*1	61,45
E98-4	8	M16*1	63,65
E98-5	10	M20*1	84,40
E98-6	12	M22*1	102,75

Indbyg indsats push-in MESSING



Varenr.	Ø	DKK
E107-2	4	16,95
E107-4	6	18,20
E107-5	8	19,45
E107-6	10	22,85

Indbyg indsats bor STÅL

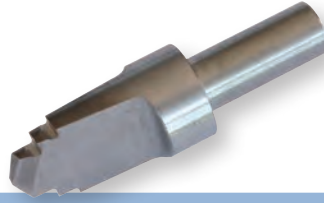

Varenr.	Ø	DKK
E108-1	4	2409,25
E108-3	6	2590,50
E108-4	8	2754,25
E108-5	10	2925,25

Y-stk push-in MESSING



Varenr.	Ø	DKK
E111-1	6	77,25
E111-2	8	92,85

Nippel m. rørstykke MESSING - BSPP



Varenr.	Ø × BSPP	DKK
E105-1	4 × M5	10,30
E105-2	4 × 1/8"	10,70
E105-3	4 × 1/4"	13,55
E105-6	6 × 1/8"	10,70
E105-7	6 × 1/4"	13,55
E105-8	8 × 1/8"	10,70
E105-9	8 × 1/4"	13,55
E105-10	10 × 1/4"	14,45
E105-11	10 × 3/8"	17,90
E105-12	12 × 3/8"	19,45
E105-13	12 × 1/2"	25,35

Indbyg inds. monterværktøj STÅL

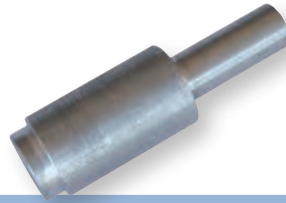

Varenr.	Ø	DKK
E109-1	4	794,00
E109-3	6	869,25
E109-4	8	962,50
E109-5	10	1035,25

Samler m. rørender MESSING



Varenr.	Ø	DKK
E106-1	4	9,25
E106-3	6	9,25
E106-4	8	11,45
E106-5	10	14,45
E106-6	12	17,90

Slangenippel push-in MESSING



Varenr.	A × B	DKK
E110-1	7 × 5	42,20
E110-2	7 × 6	38,90
E110-3	10 × 8	37,50
E110-4	10 × 10	37,50
E110-6	13 × 12	61,45
E110-7	14,5 × 14	68,85

PUSH-ON FITTINGS MESSING



-0,99bar - 15bar



-20°C til +80°C



Push-on fittings er særdeles velegnet til luft og væsker i lavtryk området.

Ved push-on sættes slangen ned over en midterstuds med krave, der udvider slangen. Omløberens hul passer til den ikke-udvidede slange og klemmer derfor slangen fast, når den skrues på. Løsnes omløberen, kan slangen fjernes igen.

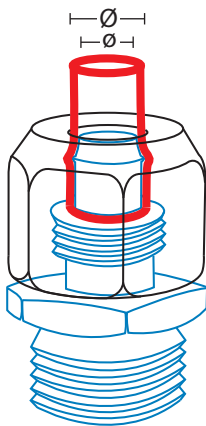

Nippel/push-on

MESSING - BSPT



Varenr.	Ø/ø × BSPT	DKK
E50-1	4/2,5 × 1/8"	17,25
E50-2	5/3 × 1/8"	11,65
E50-4	6/4 × 1/8"	10,30
E50-5	6/4 × 1/4"	11,90
E50-6	6/4 × 3/8"	23,75
E50-7	8/6 × 1/8"	11,90
E50-8	8/6 × 1/4"	12,85
E50-9	8/6 × 3/8"	20,75
E50-9-1	8/6 × 1/2"	21,65
E50-16	10/7 × 1/4"	15,30
E50-17	10/7 × 3/8"	22,55
E50-10-1	10/8 × 1/8"	15,45
E50-10	10/8 × 1/4"	14,45
E50-11	10/8 × 3/8"	21,25
E50-12	10/8 × 1/2"	36,70
E50-13	12/10 × 3/8"	27,55
E50-14	12/10 × 1/2"	40,25
E50-15	15/12,5 × 1/2"	47,20

Nippel svivel/push-on

MESSING - BSPT



Varenr.	Ø/ø × BSPT	DKK
E66-1	6/4 × 1/8"	30,10
E66-2	6/4 × 1/4"	34,75
E66-3	8/6 × 1/8"	33,10
E66-4	8/6 × 1/4"	35,85
E66-5	10/8 × 1/4"	39,15
E66-6	12/10 × 3/8"	42,50

Nippel/push-on

MESSING - BSPP



Varenr.	Ø/ø × dim	DKK
E51-1	4/2,7 × M5	17,90
E51-1-1	4/2,7 × M6	16,70
E51-2	4/2,7 × 1/8"	17,90
E51-3	5/3 × M5	9,40 α
E51-3-1	5/3 × M6	9,55
E51-4	5/3 × 1/8"	11,70
E51-5	6/4 × M5	10,75
E51-6	6/4 × 1/8"	11,30
E51-6-2	6/4 × M12*1	15,15
E51-6-3	6/4 × M12*1,25	15,15
E51-6-4	6/4 × M12*1,5	15,15
E51-7	6/4 × 1/4"	14,45
E51-8	6/4 × 3/8"	23,45
E51-9	6/4 × 1/2"	26,00
E51-11	8/6 × 1/8"	12,35
E51-12	8/6 × 1/4"	15,30
E51-13	8/6 × 3/8"	21,25
E51-13-1	8/6 × 1/2"	33,50
E51-14	10/8 × 1/8"	21,00
E51-15	10/8 × 1/4"	16,05
E51-16	10/8 × 3/8"	22,85
E51-17	10/8 × 1/2"	37,85
E51-18	12/10 × 3/8"	28,70
E51-19	12/10 × 1/2"	41,45
E51-20	15/12,5 × 1/2"	44,95

α = mini type

Nippel svivel/push-on

MESSING - BSPP



Varenr.	Ø/ø × BSPP	DKK
E66C-1	6/4 × 1/8"	18,85
E66C-2	6/4 × 1/4"	20,60
E66C-3	8/6 × 1/8"	19,85
E66C-4	8/6 × 1/4"	21,90
E66C-5	10/8 × 1/4"	23,45
E66C-6	12/10 × 3/8"	32,30

Muffe/push-on

MESSING - BSPP



Varenr.	Ø/ø × BSPP	DKK
E52-2	5/3 × 1/8"	16,05
E52-3	6/4 × 1/8"	12,85
E52-4	6/4 × 1/4"	16,95
E52-5	8/6 × 1/8"	14,45
E52-6	8/6 × 1/4"	17,25
E52-7	8/6 × 3/8"	33,90
E52-7-1	8/6 × 1/2"	35,50
E52-8	10/8 × 1/4"	19,80
E52-9	10/8 × 3/8"	34,75
E52-10	12/10 × 3/8"	48,30

Omløber push-on

MESSING



Med aflastningsfjeder

Varenr.	Ø/ø	Int. dim	DKK
E53-1	6/4	M10*1	18,45
E53-2	8/6	M12*1	21,25
E53-3	10/8	M14*1	26,35
E53-4	12/10	M16*1	32,00

Union push-on

MESSING



Varenr.	Ø/ø	DKK
E54-0	4/2,7	19,80 α
E54-1	5/3	22,15 α
E54-2	5/3	21,00
E54-3	6/4	18,80
E54-3-1	6/4 × 5/3	18,05
E54-4	8/6	21,60
E54-8	10/7	28,40
E54-5	10/8	27,25
E54-5-1	10/8 × 6/4	28,40
E54-5-2	10/8 × 8/6	27,20
E54-6	12/10	53,55
E54-7	15/12,5	93,40

α = mini type

Skotgennemføring push-on

MESSING



Varenr.	Ø/ø	Ext. dim	L	DKK
E55-1	4/2,7	M6*0,5	35	32,55
E55-2	5/3	M7*0,75	35	31,20
E55-3	6/4	M10*1	45,5	30,10
E55-4	8/6	M12*1	48,4	33,10
E55-4-1	8/6 × 6/4	M12*1	47,3	34,55
E55-5	10/8	M14*1	52	38,90
E55-5-1	10/8 × 8/6	M14*1	51,2	38,40
E55-6	12/10	M16*1	57	65,55
E55-7	15/12,5	M20*1	59	73,15

Vinkel 90° push-on MESSING

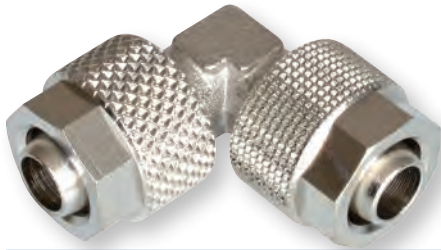

Varenr.	Ø/ø	DKK
E58-1	5/3	24,50 ₣
E58-2	5/3	23,45
E58-3	6/4	22,85
E58-4	8/6	26,05
E58-5	10/8	30,65
E58-6	12/10	61,70
E58-7	15/12,5	98,85

₣ = mini type

Vinkel 90° push-on/nip svivel MESSING

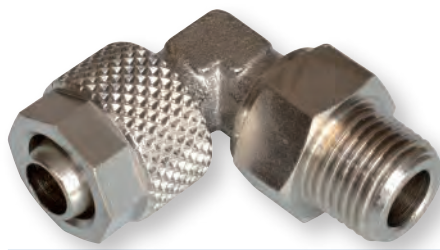

Varenr.	Ø/ø × BSPP	DKK
E76K-1	4/2,7 × 1/8"	20,90
E76K-2	6/4 × 1/8"	20,90
E76K-3	6/4 × 1/4"	24,40
E76K-4	8/6 × 1/8"	22,65
E76K-5	8/6 × 1/4"	25,10
E76K-6	10/8 × 1/4"	28,95

T-stk push-on MESSING



Varenr.	Ø/ø	DKK
E59-1	5/3	30,10 ₣
E59-2	5/3	28,40
E59-3	6/4	28,15
E59-4	8/6	30,90
E59-5	10/8	43,85
E59-6	12/10	89,85
E59-7	15/12,5	134,25

₣ = mini type

Vinkel 90° push-on/nippel MESSING - BSPT



Varenr.	Ø/ø × dim	DKK
E56-16	4/2,5 × M5	21,95
E56-1	4/2,5 × 1/8"	23,75
E56-2MINI	5/3 × 1/8"	14,55
E56-3	5/3 × 1/8"	14,45
E56-17	6/4 × M12*1	₣
E56-18	6/4 × M12*1,25	₣
E56-19	6/4 × M12*1,5	₣
E56-4	6/4 × 1/8"	13,55
E56-5	6/4 × 1/4"	14,75
E56-6	6/4 × 3/8"	28,15
E56-7	8/6 × 1/8"	16,30
E56-8	8/6 × 1/4"	17,25
E56-9	8/6 × 3/8"	28,70
E56-9-1	8/6 × 1/2"	35,05
E56-20	10/7 × 1/4"	24,50
E56-21	10/7 × 3/8"	30,90
E56-10	10/8 × 1/8"	23,20
E56-11	10/8 × 1/4"	23,20
E56-12	10/8 × 3/8"	29,50
E56-13	12/10 × 3/8"	47,20
E56-14	12/10 × 1/2"	61,70
E56-15	15/12,5 × 1/2"	74,30

₣ = spørg på pris

Vinkel 90° push-on/nippel MESSING



Varenr.	Ø/ø × BSPP	DKK
E76C-1	4/2,7 × 1/8"	20,90
E76C-2	6/4 × 1/8"	20,90
E76C-3	6/4 × 1/4"	24,40
E76C-4	8/6 × 1/8"	22,65
E76C-5	8/6 × 1/4"	25,10
E76C-6	10/8 × 1/4"	28,95

Vinkel 90° push-on/muffe MESSING - BSPP

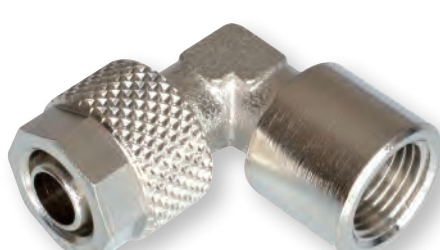

Varenr.	Ø/ø × BSPP	DKK
E57-1	5/3 × 1/8"	22,20
E57-2	6/4 × 1/8"	21,60
E57-3	6/4 × 1/4"	31,50
E57-4	8/6 × 1/8"	24,50
E57-5	8/6 × 1/4"	32,30
E57-6	10/8 × 1/4"	33,65
E57-7	12/10 × 3/8"	68,50

T-stk push-on/nippel gren MESSING - BSPT



Varenr.	Ø/ø × BSPT × Ø/ø	DKK
E60-1	5/3 × 1/8" × 5/3	26,05 ₣
E60-2	5/3 × 1/8" × 5/3	24,75
E60-3	6/4 × 1/8" × 6/4	24,50
E60-4	6/4 × 1/4" × 6/4	25,65
E60-5	8/6 × 1/8" × 8/6	26,35
E60-6	8/6 × 1/4" × 8/6	28,40
E60-7	10/8 × 1/4" × 10/8	39,15
E60-8	10/8 × 3/8" × 10/8	43,85
E60-9	12/10 × 3/8" × 12/10	83,30
E60-10	12/10 × 1/2" × 12/10	87,65
E60-11	15/12,5 × 1/2" × 15/12,5	122,00

₣ = mini type

T-stk push-on/nip svivel MESSING - BSPT



Varenr.	Ø/ø × BSPT × Ø/ø	DKK
E77K-1	6/4 × 1/8" × 6/4	28,95
E77K-2	6/4 × 1/4" × 6/4	27,65
E77K-3	8/6 × 1/8" × 8/6	28,95
E77K-4	8/6 × 1/4" × 8/6	27,65
E77K-6	10/8 × 1/4" × 10/8	28,95

T-stk push-on/nip svivel

MESSING - BSPT



Varenr.	Ø/ø × BSPT × Ø/ø	DKK
E77C-1	6/4 × 1/8" × 6/4	27,65
E77C-2	6/4 × 1/4" × 6/4	31,20
E77C-3	8/6 × 1/8" × 8/6	30,35
E77C-4	8/6 × 1/4" × 8/6	33,10
E77C-5	10/8 × 1/8" × 10/8	39,75
E77C-6	10/8 × 1/4" × 10/8	41,10

T-stk push-on/nippel ende

MESSING - BSPT



Varenr.	Ø/ø × Ø/ø × BSPT	DKK
E61-2	5/3 × 5/3 × 1/8"	24,75 α
E61-3	6/4 × 6/4 × 1/8"	24,50
E61-4	6/4 × 6/4 × 1/4"	25,65
E61-5	8/6 × 8/6 × 1/8"	26,35
E61-6	8/6 × 8/6 × 1/4"	28,40
E61-7	10/8 × 10/8 × 1/4"	39,15
E61-8	10/8 × 10/8 × 3/8"	43,85
E61-9	12/10 × 12/10 × 3/8"	83,30
E61-10	12/10 × 12/10 × 1/2"	89,60
E61-11	15/12,5 × 15/12,5 × 1/2"	122,00

α = mini type

Kryds push-on

MESSING



Varenr.	Ø/ø	DKK
E62-1	5/3	58,45
E62-2	6/4	56,85
E62-3	8/6	67,75
E62-4	10/8	78,35
E62-5	12/10	130,75
E62-6	15/12,5	167,75

Banjonippel push-on

MESSING



Varenr.	Ø/ø × dim	DKK
E63-17	4/2,5 × M5	46,95
E63-18	4/2,5 × 1/8"	46,95
E63-1	5/3 × M5	18,80
E63-3	5/3 × 1/8"	21,25
E63-4	6/4 × M5	19,10
E63-6	6/4 × 1/8"	21,00
E63-7	6/4 × 1/4"	22,85
E63-8	8/6 × 1/8"	23,45
E63-9	8/6 × 1/4"	24,75
E63-10	8/6 × 3/8"	37,00
E63-11	10/8 × 1/4"	25,35
E63-12	10/8 × 3/8"	39,75
E63-13	10/8 × 1/2"	49,35
E63-14	12/10 × 3/8"	48,30
E63-15	12/10 × 1/2"	56,85
E63-16	15/12,5 × 1/2"	66,10

Banjonippel dbl push-on

MESSING



Varenr.	Ø/ø × dim	DKK
E78-18	4/2,7 × M5	16,50
E78-19	4/2,7 × 1/8"	27,10
E78-1	5/3 × M5	17,10
E78-2	5/3 × 1/8"	25,75
E78-3	6/4 × M5	20,00
E78-4	6/4 × 1/8"	25,95
E78-5	6/4 × 1/4"	29,25
E78-6	6/4 × 3/8"	33,90
E78-7	8/6 × 1/8"	28,70
E78-8	8/6 × 1/4"	28,70
E78-9	8/6 × 3/8"	33,90
E78-10	8/6 × 1/2"	39,15
E78-11	10/8 × 1/8"	31,50
E78-12	10/8 × 1/4"	31,75
E78-13	10/8 × 3/8"	36,20
E78-14	10/8 × 1/2"	43,35
E78-15	12/10 × 3/8"	41,70
E78-16	12/10 × 1/2"	46,35
E78-17	15/12,5 × 1/2"	55,20

Vinkel 90° push-on/nip svivel

MESSING - BSPP



Med Unbrako i top for nem montering

Varenr.	Ø/ø × BSPP	DKK
E67-1	6/4 × 1/8"	59,75 α
E67-2	6/4 × 1/4"	74,20 α
E67-3	8/6 × 1/8"	74,20 α
E67-4	8/6 × 1/4"	74,20 α
E67-5	10/8 × 1/4"	76,25 α
E67-6	10/8 × 3/8"	101,00 α
E67-7	12/10 × 3/8"	105,25 α

α = så længe lager haves

Banjo push-on/nippel

MESSING - BSPP



Varenr.	Ø/ø × BSPP	DKK
E72-2	4/2,5 × 1/8"	42,75 α
E72-5	6/4 × M5	33,10 α
E72-8	8/6 × 1/8"	40,25 α
E72-11	10/8 × 1/4"	48,85 α
E72-13	10/8 × 1/2"	98,85 α

α = så længe lager haves

Banjobolt
MESSING - BSPP



Varenr.	BSPP	DKK
E100-1	M5	11,05
E100-2	1/8"	16,95
E100-3	1/4"	33,10
E100-4	3/8"	45,50
E100-5	1/2"	70,45

Banjo dbl push-on/nippel
MESSING - BSPP



Varenr.	Ø/ø × dim × Ø/ø	DKK
E73-1	5/3 × M5 × 5/3	52,15
E73-2	5/3 × 1/8" × 5/3	58,15
E73-3	6/4 × M5 × 6/4	52,15
E73-4	6/4 × 1/8" × 6/4	58,15
E73-5	6/4 × 1/4" × 6/4	65,55
E73-6	8/6 × 1/8" × 8/6	59,25
E73-7	8/6 × 1/4" × 8/6	65,55
E73-8	8/6 × 3/8" × 8/6	84,40
E73-9	10/8 × 1/4" × 10/8	71,55
E73-10	10/8 × 3/8" × 10/8	88,20
E73-11	10/8 × 1/2" × 10/8	117,50
E73-12	12/10 × 3/8" × 12/10	97,45
E73-13	12/10 × 1/2" × 12/10	130,75
E73-14	15/12,5 × 1/2" × 15/12,5	142,50

Banjobolt dobbelt
MESSING - BSPP



Varenr.	dim	DKK
E101-1	1/8"	21,95
E101-2	1/4"	31,50
E101-3	3/8"	41,10
E101-4	1/2"	68,85

Banjobolt trippel
MESSING - BSPP



Varenr.	dim	DKK
E102-1	1/8"	47,20
E102-2	1/4"	54,60
E102-3	3/8"	80,00
E102-4	1/2"	99,40

Omløber push-on
MESSING



Varenr.	Ø	Int. dim	DKK
E71-2	6	M8*0,75	4,62
E71-4	6	M10*1	4,96
E71-5	8	M12*1	5,95
E71-6	10	M14*1	7,05
E71-7	12	M16*1	11,60
E71-8	15	M20*1	18,45



525

GEVINDFITTINGS MESSING TIL PNEUMATIK



Et omfattende program af rørfittings til pneumatik.

Tryk: 1/8" = 150bar
 1/4" = 100bar,
 3/8" = 70bar
 1/2" = 50bar
 3/4" = 85bar
 1" = 80bar

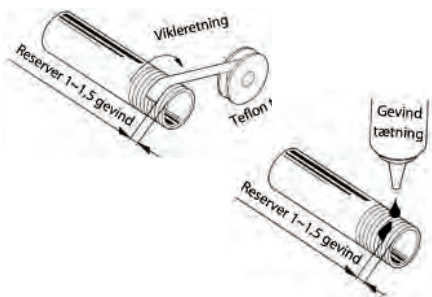

Brystnippel MESSING - BSPT



Varenr.	BSPT	L	DKK
E1-12R	3/4" x 3/8"	75	12,70 α
E1-16R	1" x 3/4"	80	21,25 α
E1-17R	1"	80	22,95 α
E1-18R	1 1/4"		43,75 α

α = så længe lager haves

Muffe sekskant MESSING - BSPP



Varenr.	BSPP	L	DKK
E8-8R	1/2" x 1/4"	28mm	9,85 α
E8-9R	1/2" x 3/8"	28mm	9,45 α
E8-12R	3/4" x 1/2"	32mm	16,65 α
E8-13R	3/4"	33mm	14,60 α

α = så længe lager haves

Spidsmuffe MESSING - BSPP x BSPT



Varenr.	Muf x nip	L	DKK
E4-14R	1/2"	32,5mm	9,05 α

α = så længe lager haves

Rørprop sekskant MESSING - BSPT



Varenr.	BSPT	DKK
E9K-5R	3/4"	9,45 α
E9K-6R	1"	15,95 α

α = så længe lager haves

Denne serie af varer udgår, men har du behov for mere end 1.000 stk. giver vi meget gerne en uforpligtende pris.

Ring 75 945 955

Nippelmuffe MESSING - BSPP x BSPT



Varenr.	Nip x muf	L	DKK
E6-11R	1" x 3/8"	26mm	14,10 α

α = så længe lager haves

Vinkel 90° muf/muf
MESSING - BSPP



65 %
DISCOUNT

Varenr.	BSPP	DKK
E17-4R	1/2"	18,55 ₺

₺ = så længe lager haves

T-stk m. nipler
MESSING - BSPT



65 %
DISCOUNT

Varenr.	BSPT	DKK
E24-1R	1/8"	5,85 ₺
E24-2R	1/4"	7,65 ₺
E24-3R	3/8"	12,30 ₺
E24-4R	1/2"	20,75 ₺

₺ = så længe lager haves

Denne serie af varer udgår, men har du behov for mere end 1.000 stk. giver vi meget gerne en uforpligtende pris.

Ring 75 945 955

Vinkel 90° nip/muf
MESSING - BSPT×BSPP



65 %
DISCOUNT

Varenr.	BSPT×BSPP	DKK
E18-1R	1/8"	7,75 ₺
E18-3R	1/4" × 3/8"	27,55 ₺

₺ = så længe lager haves

Y-stk m. muffler
MESSING - BSPP



65 %
DISCOUNT

Varenr.	BSPP	DKK
E26-1R	1/8"	5,50 ₺
E26-2R	1/4"	8,05 ₺

₺ = så længe lager haves

Vinkel 90° nip/nip
MESSING - BSPT



65 %
DISCOUNT

Varenr.	BSPT	DKK
E19-1R	1/8"	12,25 ₺
E19-5R	1/4" × 1/2"	11,15 ₺
E19-6R	3/8"	8,55 ₺

₺ = så længe lager haves

Y-stk nip/muf/muf
MESSING - BSPT×BSPP



65 %
DISCOUNT

Varenr.	BSPT × 2-BSPP	DKK
E27-1R	1/8"	5,75 ₺

₺ = så længe lager haves

T-stk m. muffler
MESSING - BSPP



65 %
DISCOUNT

Varenr.	BSPP	DKK
E20-4R	1/2"	25,80 ₺

₺ = så længe lager haves

Brystnippel

MESSING - BSPT



Varenr.	BSPT	bar	DKK
E1-1	1/8"	150	6,70
E1-2	1/8" x 1/4"	100	8,75
E1-3	1/8" x 3/8"	75	10,75
E1-4	1/4"	100	8,75
E1-5	1/4" x 3/8"	75	12,00
E1-6	1/4" x 1/2"	50	18,40
E1-7	3/8"	75	11,80
E1-8	3/8" x 1/2"	50	19,40
E1-9	1/2"	50	19,40
E1-10	1/2" x 3/4"	50	36,20
E1-11	3/4"	85	36,20
E1-12	3/4" x 1"	80	77,85
E1-13	1"	80	79,45

Spidsmuffe muf/nip

MESSING - BSPPxBSPT



Varenr.	BSPPxBSPT	bar	DKK
E3-1	1/8"	150	7,70
E3-2	1/4" x 1/8"	100	10,30
E3-3	3/8" x 1/8"	75	17,15
E3-4	1/4"	100	10,75
E3-5	3/8" x 1/4"	75	16,90
E3-6	1/2" x 1/4"	50	26,15
E3-7	3/8"	75	18,75
E3-8	1/2" x 3/8"	50	26,15
E3-10	3/4" x 3/8"	85	42,75
E3-9	1/2"	50	28,95
E3-11	3/4" x 1/2"	50	45,50
E3-13	1" x 1/2"	50	67,75
E3-12	3/4"	85	47,20
E3-14	1" x 3/4"	85	70,45
E3-15	1"	80	72,10

Forlænger

MESSING - BSPTxBSPP



Varenr.	BSPTxBSPP	L tot	X	DKK
E5-1	1/8"	22mm	14	8,35
E5-0	1/8"	23mm	12	10,20
E5-5	1/8"	32mm	14	17,85
E5-6	1/8"	42mm	14	20,90
E5-2	1/8"	44mm	12	14,20
E5-7	1/8"	51mm	14	30,65
E5-8	1/4"	28mm	16	16,00
E5-3	1/4"	28mm	17	12,15
E5-9	1/4"	35mm	17	20,60
E5-4	1/4"	45mm	16	17,85
E5-10	1/4"	51mm	17	28,95
E5-11	3/8"	41mm	22	43,85
E5-12	1/2"	36mm	24	42,75
E5-13	3/4"	50mm	30	90,65
E5-14	1"	50mm	38	135,25

X = nøglevidde

Brystnippel

MESSING - BSPP



Varenr.	BSPP	bar	DKK
E2-1	M5		5,70
E2-2	M5 x 1/8"		7,70
E2-3	1/8"	150	7,70
E2-4	1/8" x 1/4"	100	10,20
E2-5	1/8" x 3/8"	75	12,15
E2-6	1/4"	100	10,95
E2-7	1/4" x 3/8"	75	12,15
E2-8	1/4" x 1/2"	50	18,40
E2-9	3/8"	75	15,05
E2-10	3/8" x 1/2"	50	21,55
E2-11	1/2"	50	24,35
E2-12	1/2" x 3/4"	50	46,05
E2-13	3/4"	85	49,10
E2-14	3/4" x 1"	80	63,65
E2-15	1"	80	66,10

Spidsmuffe

MESSING - BSPPxBSPP



Varenr.	BSPPxBSPP	bar	DKK
E4-1	M5		5,70
E4-2	1/8" x M5		7,70
E4-3	1/8"	150	7,70
E4-4	1/4" x 1/8"	100	10,30
E4-5	3/8" x 1/8"	75	17,15
E4-6	1/4"	100	10,75
E4-7	3/8" x 1/4"	75	16,90
E4-8	1/2" x 1/4"	50	26,15
E4-9	3/8"	75	18,75
E4-10	1/2" x 3/8"	50	26,15
E4-12	3/4" x 3/8"	75	42,75
E4-11	1/2"	50	28,95
E4-13	3/4" x 1/2"	50	45,50
E4-15	1" x 1/2"	50	67,75
E4-14	3/4"	85	47,20
E4-16	1" x 3/4"	85	70,45
E4-17	1"	80	72,10

Adapter

MESSING - BSPPxNPT



Varenr.	BSPPxNPT	bar	DKK
E74-1	1/8"	150	17,00
E74-2	1/4"	100	20,15
E74-3	3/8"	75	47,30

Adapter

MESSING - NPTxBSPP



Varenr.	NPTxBSPP	bar	DKK
E75-1	1/8"	150	11,40
E75-2	1/4"	100	23,85
E75-3	3/8"	75	44,10
E75-4	1/2"	50	59,25

Nippelmuffe smal

MESSING - BSPT×BSPP



Varenr.	Nip × muf	bar	DKK
E6-1	1/4" × 1/8"	100	7,30
E6-2	3/8" × 1/8"	75	9,50
E6-3	3/8" × 1/4"	75	9,20
E6-12	1/2" × 1/8"	50	18,75
E6-4	1/2" × 1/4"	50	15,05
E6-5	1/2" × 3/8"	50	13,70
E6-6	3/4" × 1/4"	85	32,55
E6-7	3/4" × 3/8"	75	31,75
E6-8	3/4" × 1/2"	50	27,00
E6-9	1" × 3/8"	75	62,80
E6-10	1" × 1/2"	50	58,15
E6-11	1" × 3/4"	80	56,85

Nippelmuffe bred

MESSING - BSPP



Varenr.	Nip × muf	bar	DKK
E7-1	1/8" × M5		7,70
E7-2	1/4" × 1/8"	100	8,65
E7-3	3/8" × 1/8"	75	10,75
E7-4	3/8" × 1/4"	75	10,75
E7-13	1/2" × 1/8"	50	18,75
E7-5	1/2" × 1/4"	50	16,90
E7-6	1/2" × 3/8"	50	15,05
E7-7	3/4" × 1/4"	85	39,15
E7-8	3/4" × 3/8"	75	38,10
E7-9	3/4" × 1/2"	50	36,20
E7-10	1" × 3/8"	75	67,75
E7-11	1" × 1/2"	50	62,80
E7-12	1" × 3/4"	80	58,15

Nippelmuffe bred

MESSING / NBR - BSPP



Varenr.	Nip × muf	bar	DKK
E7R-1	1/8" × M5		8,00
E7R-2	1/4" × 1/8"	100	9,65
E7R-3	3/8" × 1/8"	75	13,85
E7R-4	3/8" × 1/4"	75	12,95
E7R-5	1/2" × 1/4"	50	22,65
E7R-6	1/2" × 3/8"	50	20,75
E7R-9	3/4" × 1/2"	50	41,45

Muffe sekskant

MESSING - BSPP



Varenr.	BSPP	bar	DKK
E8-1	M5		6,70
E8-2	M5 × 1/8"		9,75
E8-3	1/8"	150	8,65
E8-4	1/8" × 1/4"	100	12,15
E8-5	1/8" × 3/8"	75	15,05
E8-6	1/8" × 1/2"	50	43,85
E8-7	1/4"	100	12,15
E8-8	1/4" × 3/8"	75	18,40
E8-9	1/4" × 1/2"	50	20,60
E8-10	3/8"	75	17,85
E8-11	3/8" × 1/2"	50	25,85
E8-12	1/2"	50	27,90
E8-13	1/2" × 3/4"	50	42,75
E8-14	3/4"	85	44,40
E8-15	3/4" × 1"	80	99,10
E8-16	1"	80	101,25

Rørprop

MESSING - BSPP



Varenr.	BSPP	bar	DKK
E9-7	M5		3,25
E9-1	1/8"	150	4,08
E9-2	1/4"	100	5,80
E9-3	3/8"	75	10,75
E9-4	1/2"	50	15,70
E9-5	3/4"	85	22,45
E9-6	1"	80	45,50

Rørprop sekskant

MESSING - BSPT



Varenr.	BSPT	bar	DKK
E9K-1	1/8"	150	8,70
E9K-2	1/4"	100	9,60
E9K-3	3/8"	75	11,75
E9K-4	1/2"	50	17,00
E9K-5	3/4"	85	25,40
E9K-6	1"	80	30,30

Rørprop Unbrako

MESSING / NBR - BSPP



Varenr.	BSPP	bar	DKK
E29-1	M5		12,65
E29-2	1/8"	150	12,65
E29-3	1/4"	100	15,40
E29-4	3/8"	75	21,85
E29-5	1/2"	50	44,70

Rørprop Unbrako

MESSING - BSPP



Varenr.	BSPP	bar	DKK
E10-1	1/8"	150	5,35
E10-2	1/4"	100	6,25
E10-3	3/8"	75	7,30
E10-4	1/2"	50	10,60

Rørprop Unbrako

MESSING - BSPT



Varenr.	BSPT	bar	DKK
E11-1	1/8"	150	5,35
E11-2	1/4"	100	6,25
E11-3	3/8"	75	7,30
E11-4	1/2"	50	10,60

Slutmuffe sekskant

MESSING - BSPP



Varenr.	BSPP	bar	DKK
E12-1	1/8"	150	5,70
E12-2	1/4"	100	8,45
E12-3	3/8"	75	12,90
E12-4	1/2"	50	16,90
E12-5	3/4"	85	26,15
E12-6	1"	80	44,70

Kontramøtrik fornicket

MESSING - BSPP



Varenr.	BSPP	- -	bar	DKK
E14-1	1/8"	3,4	150	3,25
E14-2	1/4"	5	100	3,58
E14-3	1/4"	3	100	4,41
E14-4	3/8"	4	75	5,25
E14-5	1/2"	6	50	7,55
E14-6	3/4"	5	85	12,65
E14-7	1"	6	80	21,55

Reduktionsindsats

MESSING - BSPP



Varenr.	Udvoxindv	DKK
E15-1	1/8" × M5	13,30
E15-2	1/4" × 1/8"	11,20
E15-3	3/8" × 1/8"	14,20
E15-4	3/8" × 1/4"	14,20
E15-5	1/2" × 1/4"	19,70
E15-6	1/2" × 3/8"	19,70
E15-7	3/4" × 1/2"	39,15
E15-8	1" × 3/4"	58,15

Slangenippel fornicket

MESSING - BSPP



Varenr.	Ø × BSPP	bar	DKK
E13-0	4,5 × M5		10,60
E13-1	7 × 1/8"	150	9,35
E13-4	7 × 1/4"	100	10,60
E13-2	8 × 1/8"	150	9,35
E13-5	8 × 1/4"	100	10,60
E13-3	9 × 1/8"	150	9,35
E13-6	9 × 1/4"	100	10,60
E13-8	9 × 3/8"	75	16,20
E13-7	12 × 1/4"	100	10,60
E13-9	12 × 3/8"	75	16,20
E13-11	12 × 1/2"	50	26,00
E13-10	17 × 3/8"	75	16,20
E13-12	17 × 1/2"	50	26,00

Slangenippel fornicket

MESSING / NBR - BSPP



Varenr.	Ø × BSPP	bar	DKK
E13R-0	4,5 × M5		9,35
E13R-1	7 × 1/8"	150	9,30
E13R-2	7 × 1/4"	100	12,10
E13R-3	8 × 1/8"	150	9,70
E13R-4	8 × 1/4"	100	13,35
E13R-5	9 × 1/8"	150	11,15
E13R-6	9 × 1/4"	100	12,40
E13R-7	9 × 3/8"	75	16,20
E13R-8	12 × 1/4"	100	13,65
E13R-9	12 × 3/8"	75	16,20
E13R-10	12 × 1/2"	50	25,60
E13R-11	17 × 3/8"	75	19,05
E13R-12	17 × 1/2"	50	26,30

Slangenippel m. indv. gevind

MESSING - BSPP

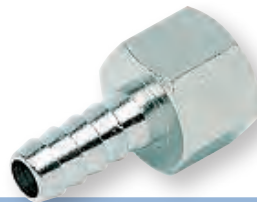

Varenr.	Ø × BSPP	bar	DKK
E13F-1	6 × 1/8"	150	12,20
E13F-2	7 × 1/8"	150	12,20
E13F-4	7 × 1/4"	100	13,00
E13F-5	8 × 1/4"	100	14,00
E13F-6	9 × 1/4"	100	14,00
E13F-7	9 × 3/8"	75	17,40
E13F-8	10 × 3/8"	75	17,40
E13F-9	12 × 3/8"	75	17,40
E13F-10	12 × 1/2"	50	25,55

Slangenippel fornicket

MESSING - BSPT



Varenr.	Ø × BSPT	bar	DKK
E13K-1	6 × 1/8"	150	12,90
E13K-2	6 × 1/4"	100	14,80
E13K-3	7 × 1/8"	150	12,90
E13K-4	7 × 1/4"	100	14,00
E13K-5	8 × 1/8"	150	14,00
E13K-6	8 × 1/4"	100	14,00
E13K-7	9 × 1/8"	150	14,00
E13K-8	9 × 1/4"	100	14,00
E13K-9	9 × 3/8"	75	16,00
E13K-10	9 × 1/2"	50	16,00
E13K-11	10 × 1/8"	150	16,00
E13K-12	10 × 1/4"	100	14,00
E13K-13	10 × 3/8"	75	16,00
E13K-14	10 × 1/2"	50	27,20
E13K-15	12 × 1/4"	100	17,95
E13K-16	12 × 3/8"	75	16,00
E13K-17	12 × 1/2"	50	22,55
E13K-18	14 × 3/8"	75	33,30
E13K-19	14 × 1/2"	50	33,30
E13K-20	16 × 1/4"	100	20,60
E13K-21	16 × 3/8"	75	22,55
E13K-22	16 × 1/2"	50	22,55
E13K-22-1	16 × 3/4"	85	37,25
E13K-24	17 × 3/8"	75	22,55
E13K-24-1	17 × 1/2"	50	22,55
E13K-26	18 × 3/8"	75	22,55
E13K-25	18 × 1/2"	50	22,55
E13K-27	18 × 3/4"	85	37,25
E13K-28	20 × 3/8"	75	42,40
E13K-29	20 × 1/2"	50	42,40
E13K-30	20 × 3/4"	85	42,40
E13K-31	25 × 3/4"	85	50,85
E13K-32	25 × 1"	80	80,55

Vinkel 90° muf/muf
MESSING - BSPP



Varenr.	BSPP	bar	DKK
E17-1	1/8"	150	16,60
E17-2	1/4"	100	22,10
E17-3	3/8"	75	29,50
E17-4	1/2"	50	47,45
E17-5	3/4"	85	81,65
E17-6	1"	80	136,25

Vinkel 90° nip/nip
MESSING - BSPT



Varenr.	BSPT	bar	DKK
E19-1	1/8"	150	16,60
E19-2	1/4"	100	21,15
E19-3	3/8"	75	30,65
E19-4	1/2"	50	48,30
E19-5	3/4"	85	74,55
E19-6	1"	80	145,75

T-stk muf/nip/muf
MESSING - BSPP×BSPT



Varenr.	BSPP × BSPT × BSPP	bar	DKK
E21-1	1/8"	150	19,70
E21-2	1/4"	100	26,70
E21-3	3/8"	75	39,40
E21-4	1/2"	50	69,90
E21-5	3/4"	85	110,25
E21-6	1"	80	152,75

Vinkel 90° nip/muf
MESSING - BSPT×BSPP



Varenr.	BSPT × BSPP	bar	DKK
E18-1	1/8"	150	15,70
E18-2	1/4"	100	21,55
E18-3	3/8"	75	28,95
E18-4	1/2"	50	45,50
E18-5	3/4"	85	94,75
E18-6	1"	80	196,50

Slangenippel 90°
MESSING - BSPT



Varenr.	Ø × BSPT	bar	DKK
E13V-1	6 × 1/8"	150	19,05
E13V-2	6 × 1/4"	100	19,70
E13V-4	7 × 1/8"	150	19,05
E13V-5	7 × 1/4"	100	19,70
E13V-6	9 × 1/4"	100	22,15

T-stk muf/muf/nip
MESSING - BSPP×BSPT



Varenr.	BSPP × BSPP × BSPT	bar	DKK
E22-1	1/8"	150	19,70
E22-2	1/4"	100	26,70
E22-3	3/8"	75	39,40
E22-4	1/2"	50	69,90
E22-5	3/4"	85	110,25
E22-6	1"	80	152,75

T-stk m. muffer
MESSING - BSPP



Varenr.	BSPP	bar	DKK
E20-1	1/8"	150	19,70
E20-2	1/4"	100	27,00
E20-3	3/8"	75	40,00
E20-4	1/2"	50	70,15
E20-5	3/4"	85	145,75
E20-6	1"	80	177,00

T-stk m. nipler
MESSING - BSPT



Varenr.	BSPT	bar	DKK
E24-1	1/8"	150	19,40
E24-2	1/4"	100	27,90
E24-3	3/8"	75	39,15
E24-4	1/2"	50	70,15
E24-5	3/4"	85	110,25
E24-6	1"	80	152,75

T-stk nip/muf/nip
MESSING - BSPT×BSPP



Varenr.	BSPT × BSPP × BSPT	bar	DKK
E25-1	1/8"	150	20,90
E25-2	1/4"	100	27,90
E25-3	3/8"	75	40,00
E25-4	1/2"	50	70,15
E25-5	3/4"	85	110,25
E25-6	1"	80	152,75

T-stk muf/nip/nip
MESSING - BSPP×BSPT



Varenr.	BSPP × BSPT × BSPT	bar	DKK
E24A-1	1/8"	150	15,40
E24A-2	1/4"	100	22,45
E24A-3	3/8"	75	31,50
E24A-4	1/2"	50	55,45
E24A-5	3/4"	85	88,45
E24A-6	1"	80	122,25

Kryds
MESSING - BSPP



Varenr.	BSPP	bar	DKK
E23-1	1/8"	150	32,55
E23-2	1/4"	100	38,35
E23-3	3/8"	75	58,75
E23-4	1/2"	50	116,75

Kryds m. nipler
MESSING - BSPT



Varenr.	BSPT	bar	DKK
E23A-1	1/8"	150	32,55
E23A-2	1/4"	100	38,35
E23A-3	3/8"	75	58,75
E23A-4	1/2"	50	116,75

Vinkel 90°muf/muf m. beslag
MESSING - BSPP



Varenr.	BSPP	bar	DKK
E30-5	1/2"	50	62,80

Y-stk m. muffer
MESSING - BSPP



Varenr.	BSPP	bar	DKK
E26-1	1/8"	150	23,00
E26-2	1/4"	100	28,95
E26-3	3/8"	75	47,20
E26-4	1/2"	50	73,45

Y-stk nip/muf/muf
MESSING - BSPP×BSPT



Varenr.	BSPT × 2-BSPP	bar	DKK
E27-1	1/8"	150	23,00
E27-2	1/4"	100	28,95
E27-3	3/8"	75	47,20
E27-4	1/2"	50	73,45

Skotgennemføring muf/nip
MESSING - BSPP



Varenr.	BSPP	Ext. dim	DKK
E28-1	M5	M10*1	38,35
E28-2	1/8"	M16*1,5	60,05
E28-3	1/4"	M20*1,5	86,80
E28-4	3/8"	M26*1,5	95,30
E28-5	1/2"	M28*1,5	135,25

Mini T-stk muf/nip/muf
MESSING - BSPT×BSPP



Varenr.	BSPP × BSPT × BSPP	bar	DKK
E30-1	1/8"	150	25,50
E30-2	1/4"	100	33,90

Mini vinkel 90° nip/muf
MESSING - BSPT×BSPP



Varenr.	BSPT × BSPP	bar	DKK
E30-3	1/8"	150	22,75
E30-4	1/4"	100	30,10

Banjobolt
MESSING - BSPP



Varenr.	BSPP	DKK
E100-1	M5	11,05
E100-2	1/8"	16,95
E100-3	1/4"	33,10
E100-4	3/8"	45,50
E100-5	1/2"	70,45

Banjonippel m. indiv. gevind
MESSING - BSPP



Varenr.	dim	DKK
E43-0	M5	16,90
E43-1	1/8"	16,90
E43-2	1/4"	21,85
E43-3	3/8"	29,25

Svivel
MESSING - BSPP



Varenr.	BSPP	L	DKK
E30-81	1/8"	25	16,25
E30-82	1/4"	29	21,75
E30-83	3/8"	33	42,00
E30-84	1/2"	37	68,00
E30-85	3/4"	48,5	123,00
E30-86	1"	52	167,00

Banjobolt dobbelt
MESSING - BSPP



Varenr.	dim	DKK
E101-1	1/8"	21,95
E101-2	1/4"	31,50
E101-3	3/8"	41,10
E101-4	1/2"	68,85

Union 3-delt konisk nip/nip
MESSING - BSPT

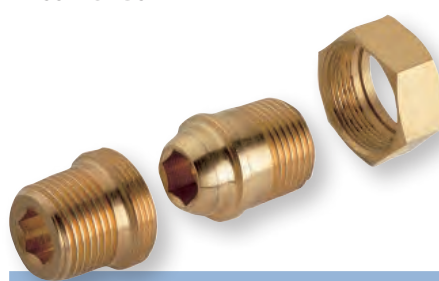

Varenr.	BSPT	DKK
E30-10	1/8"	26,45
E30-11	1/4"	34,20
E30-12	3/8"	45,50
E30-13	1/2"	132,75
E30-14	3/4"	165,50
E30-15	1"	265,00

Forlænger svivel
MESSING - BSPP×BSPT



Varenr.	BSPT × BSPP	DKK
E30-20	1/4"	40,00

Banjobolt trippel
MESSING - BSPP



Varenr.	dim	DKK
E102-1	1/8"	47,20
E102-2	1/4"	54,60
E102-3	3/8"	80,00
E102-4	1/2"	99,40

Forlænger svivel
MESSING - BSPP×BSPT



Varenr.	BSPP × BSPT	DKK
E30-61	1/8"	29,50
E30-62	1/4"	35,60
E30-63	3/8"	43,85

Nippelmuffe svivel
MESSING - BSPP×BSPT

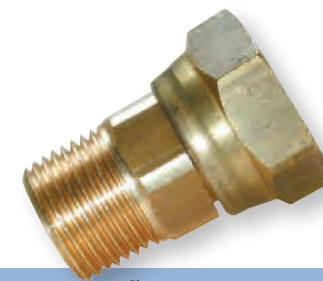

Varenr.	Ø × ø	DKK
E30-30	1/4"	81,40

Forlænger svivel
MESSING - BSPP



Varenr.	BSPP	DKK
E30-71	1/8"	29,50
E30-72	1/4"	35,60
E30-73	3/8"	43,85

Svivel nip/muf flow: 30L/min
MESSING - BSPP×BSPT



Arbejdstryk: 220bar - max: 250bar
Arbejdstemperatur: +90°C

Varenr.	BSPT × BSPP	DKK
E30s-3-2	3/8" × 1/4"	393,00
E30s-3	3/8"	164,25

Svivel nip/muf 160L/min

MESSING - 1/2" BSPP×1/2" BSPT

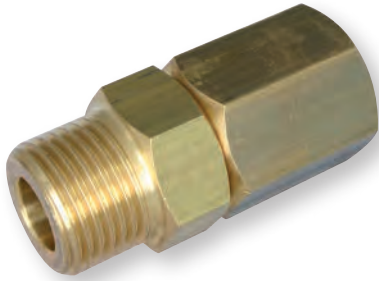

Arbejdstryk: 200bar - max: 220bar
Arbejdtemperatur: +90°C

Varenr.	BSPT × BSPP	DKK
E31s-4	1/2"	358,00

Svivel nip/muf flow: 40L/min

MESSING - BSPP×BSPT



Arbejdstryk: 250bar - max: 280bar
Arbejdtemperatur: +160°C

Varenr.	BSPT × BSPP	DKK
E32s-2	1/4"	726,25
E32s-3	3/8"	726,25
E32s-4	1/2"	339,75

Svivel nip/muf 100L/min

MESSING - 1/2" BSPP



Arbejdstryk: 24bar
Arbejdtemperatur: +90°C

Varenr.	BSPP	DKK
E33s-4	1/2"	345,50

Svivel 90° muf/nip 40L/min

MESSING - BSPP×BSPT



Arbejdstryk: 250bar - max: 280bar
Arbejdtemperatur: +90°C

Skrue = AISI 316

Varenr.	BSPP×BSPT	DKK
B42s-2	1/4"	2217,50
B42s-3	3/8"	1247,00

Fordeler

ALUMINIUM - BSPP

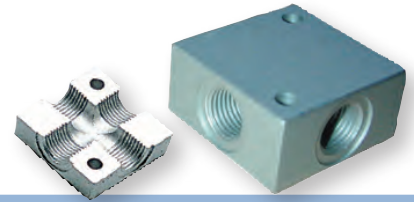

Varenr.	BSPP	DKK
EFK30-2	4-1/8"	33,10
EFK30-3	4-1/4"	52,95
EFK30-4	4-3/8"	80,25
EFK30-5	4-1/2"	93,40

Fordeler

ALUMINIUM - BSPP

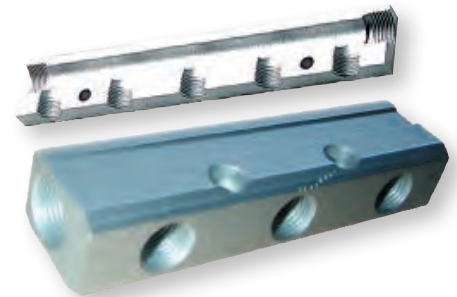

Varenr.	In × Out	DKK
EFE31-1	2-1/4" × 2-1/8"	85,70
EFE31-2	2-1/4" × 3-1/8"	123,00
EFE31-3	2-1/4" × 4-1/8"	160,75
EFE31-4	2-1/4" × 5-1/8"	196,50
EFE31-5	2-1/4" × 6-1/8"	231,00
EFE31-6	2-3/8" × 3-1/4"	124,00
EFE31-7	2-3/8" × 4-1/4"	165,50
EFE31-8	2-3/8" × 5-1/4"	208,75
EFE31-9	2-3/8" × 6-1/4"	252,00

Fordeler

ALUMINIUM - BSPP

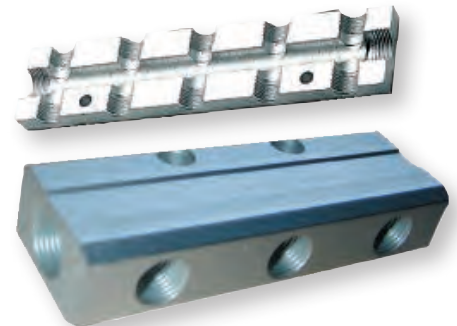

Varenr.	In × Out	DKK
EFT31-1	2-1/4" × 2-2-1/8"	110,25
EFT31-2	2-1/4" × 2-3-1/8"	147,25
EFT31-3	2-1/4" × 2-4-1/8"	208,75
EFT31-4	2-1/4" × 2-5-1/8"	362,00
EFT31-5	2-3/8" × 2-2-1/4"	196,50
EFT31-6	2-3/8" × 2-3-1/4"	212,00
EFT31-7	2-3/8" × 2-4-1/4"	233,75
EFT31-8	2-3/8" × 2-5-1/4"	270,00

LYDDÆMPERE



Messing og rustfri dæmpere max 8 bar, drøvlmodel max 10bar.



Messing og rustfri dæmpere -10°C til +70°C.
Plast dæmpere +5°C til +60°C



Et omfattende program af lydæmpere i flere forskellige materialer og udførelser.

Lyddæmper LAV MODEL

MESSING / AISI 316 - BSPT

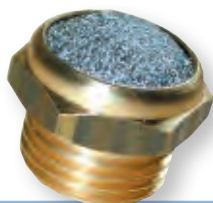

Varenr.	BSPT	L1	L total	DKK
EC1-7	M5	4	8	10,80
EC1-1	1/8"	9	15	11,25
EC1-2	1/4"	11	18	15,20
EC1-3	3/8"	12	20	25,30
EC1-4	1/2"	12	22	35,35
EC1-5	3/4"	16	26	63,65
EC1-6	1"	16	28	108,00

Støjreduktion >20dB

Lyddæmper LAV MODEL

MESSING / BRONZE - BSPT



Varenr.	BSPT	L1	L total	DKK
EC3-7	M5	7	12	9,45
EC3-1	1/8"	7	13	8,95
EC3-2	1/4"	9	16	11,60
EC3-3	3/8"	8	16	22,75
EC3-4	1/2"	8	18	31,75
EC3-5	3/4"	9	19	59,00
EC3-6	1"	10	20	98,55

Støjreduktion >20dB

Lyddæmper LAV MODEL

MESSING / BRONZE - BSPT

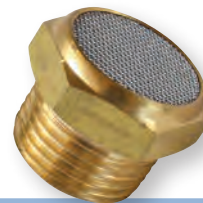

Varenr.	BSPT	NV	DKK
EC38-7	M5	8	8,40
EC38-1	1/8"	13	14,00
EC38-2	1/4"	16	21,00
EC38-3	3/8"	19	27,90
EC38-4	1/2"	24	41,70
EC38-5	3/4"	30	62,80
EC38-6	1"	36	97,75

NV = nøglevidde

Lyddæmper LAV MODEL

MESSING / AISI 304 - BSPP



Varenr.	BSPP	L1	L total	DKK
EC1F-8	1/8"	11	18	13,35

Støjreduktion >20dB

Lyddæmper LAV MODEL

MESSING / BRONZE - BSPT



Varenr.	BSPT	L	DKK
EC39-7	M5	8	5,60
EC39-1	1/8"	10	8,45
EC39-2	1/4"	11	13,95
EC39-3	3/8"	12	24,40
EC39-4	1/2"	13	41,90
EC39-5	3/4"	18	83,75
EC39-6	1"	22	83,75

Lyddæmper LAV MODEL

MESSING / BRONZE - BSPT



Varenr.	BSPT	L total	DKK
EC4-1	1/8"	5	11,00
EC4-2	1/4"	6	13,35
EC4-3	3/8"	7	26,30
EC4-4	1/2"	8	36,70
EC4-5	3/4"	9	66,10
EC4-6	1"	10	108,00

Støjreduktion >20dB

Lyddæmper LAV MODEL AISI 304 - BSPT



Varenr.	BSPT	L1	L total	DKK
EC2-7	M5	7	12	49,65
EC2-1	1/8"	9	15	87,65
EC2-2	1/4"	11	18	118,75
EC2-3	3/8"	12	20	163,00
EC2-4	1/2"	12	22	251,50
EC2-5	3/4"	16	26	339,75
EC2-6	1"	16	28	453,50

Støjreduktion >20dB

Lyddæmper MELLEML MODEL KOBBER - BSPT



Varenr.	BSPT	L1	L total	DKK
EC29-1	1/8"	22	28,5	12,85
EC29-2	1/4"	25,5	34,5	27,20
EC29-3	3/8"	26	36	40,00
EC29-4	1/2"	32	44	71,80
EC29-5	3/4"	39,5	51	121,25
EC29-6	1"	50	64	203,75

Støjreduktion >20dB

Lyddæmper MELLEML MODEL BRONZE - BSPT



Varenr.	BSPT	D	DKK
EC46-1	1/8"	7	9,85
EC46-2	1/4"	9	19,55
EC46-3	3/8"	13	41,90
EC46-4	1/2"	17	80,30
EC46-5	3/4"	19	153,75
EC46-6	1"	24	261,75

Lyddæmper LAV MODEL AISI 316 - BSPT



Varenr.	BSPT	L	NV	DKK
EC50-7	M5		8	27,45
EC50-1	1/8"	13	12	33,95
EC50-2	1/4"	15,5	15	57,85
EC50-3	3/8"	17	19	79,55
EC50-4	1/2"	21	23	123,00
EC50-5	3/4"	21,5	30	209,75
EC50-6	1"	25,5	36	325,25

NV = nøglevidde

Lyddæmper MELLEML MODEL BRONZE - BSPT



Varenr.	BSPT	L	D	DKK
EC45-1	1/8"	23	12,5	10,50
EC45-2	1/4"	29,5	16	20,95
EC45-3	3/8"	37,5	20	38,40
EC45-4	1/2"	45	26	76,75

Lyddæmper MELLEML MODEL MESSING / BRONZE - BSPT



Varenr.	BSPT	L1	L total	DKK
EC5-7	M5	11,5	17	12,65
EC5-1	1/8"	16	20,5	12,40
EC5-2	1/4"	20,5	26,5	17,50
EC5-3	3/8"	26,9	33,9	31,50
EC5-4	1/2"	32,5	40,5	42,75
EC5-5	3/4"	42,5	51,5	93,90
EC5-6	1"	55	66	135,25

Støjreduktion >20dB

Lyddæmper LAV MODEL AISI 316 - BSPT

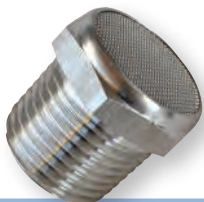

Varenr.	BSPT	L	NV	DKK
EC51-1	1/8"	13	12	33,95
EC51-2	1/4"	15,5	15	57,85
EC51-3	3/8"	17	19	79,55
EC51-4	1/2"	21	23	123,00
EC51-5	3/4"	21,5	30	209,75
EC51-6	1"	25,5	36	325,25

NV = nøglevidde

Lyddæmper MELLEML MODEL BRONZE - BSPT



Varenr.	BSPT	L	D	DKK
EC44-1	1/8"	22,5	11	10,50
EC44-2	1/4"	28	14	18,90
EC44-3	3/8"	35,5	18	43,95
EC44-4	1/2"	45	24	76,75
EC44-5	3/4"	65	29,5	125,75
EC44-6	1"	74,5	35,5	202,50

Lyddæmper MELLEML MODEL MESSING / BRONZE - BSPT



Stål kobber belagt nippel				
Varenr.	BSPT	L	D	DKK
EC40-7	M5	21	8,5	7,05
EC40-1	1/8"	22	12	9,85
EC40-2	1/4"	28,5	15	16,75
EC40-3	3/8"	38,5	19	34,90
EC40-4	1/2"	45	23	48,95
EC40-5	3/4"	57	30	90,65
EC40-6	1"	66,5	37	181,50

Lyddæmper MELLEML MODEL

MESSING / BRONZE - BSPT



Stål kobber belagt nippel

Varenr.	BSPT	L	D	DKK
EC41-1	1/8"	22	12	9,85
EC41-2	1/4"	28,5	15	16,75
EC41-3	3/8"	38,5	19	34,90
EC41-4	1/2"	45	23	48,90
EC41-5	3/4"	57	30	90,65
EC41-6	1"	66,5	37	183,00

Lyddæmper MELLEML MODEL

MESSING / BRONZE - BSPT



Varenr.	BSPT	L1	L total	DKK
EC6-1	1/8"	15	21	15,20
EC6-2	1/4"	19	27	20,50
EC6-3	3/8"	28	38	37,85
EC6-4	1/2"	33	43	52,70
EC6-5	3/4"	40	53	97,70
EC6-6	1"	48	63	163,00

Støjreduktion >20dB

Lyddæmper MELLEML MODEL

MESSING / BRONZE - BSPT



Stål kobber belagt nippel

Varenr.	BSPT	L	NV	DKK
EC42-1	1/8"	24	8	9,85
EC42-2	1/4"	31,5	10	16,75
EC42-3	3/8"	39	13	16,75
EC42-4	1/2"	46,5	15	48,90
EC42-5	3/4"	59	19	94,20
EC42-6	1"	72	24	174,50

NV = nøglevidde

Lyddæmper MELLEML MODEL

MESSING - BSPT



Varenr.	BSPT	L1	L total	DKK
EC19-0	M5	8,5	13	12,65
EC19-1	1/8"	15	21	12,95
EC19-2	1/4"	19	27	18,65
EC19-3	3/8"	28	36	31,50
EC19-4	1/2"	33	43	42,75
EC19-5	3/4"	40	53	93,90
EC19-6	1"	48	63	141,50
EC19-7	1 1/4"	65	80	849,00 α
EC19-8	1 1/2"	77	93	1132,00 α
EC19-9	2"	90	107	1585,25 α

Støjreduktion >20dB, α = >25dB

Lyddæmper MELLEML MODEL

MESSING / BRONZE - BSPT



Kobber belagt nippel

Varenr.	BSPT	L	D	DKK
EC43-7	M5	17,5	8	12,55
EC43-1	1/8"	23,5	11	24,40
EC43-2	1/8"	37	13	45,35
EC43-3	1/4"	51	14	59,35

Lyddæmper MELLEML MODEL

MESSING / BRONZE - BSPT



Varenr.	BSPT	L1	L total	DKK
EC7-1	1/8"	6	12	11,55
EC7-2	1/4"	6	14	14,15
EC7-3	3/8"	8	16	27,20
EC7-4	1/2"	8	20	36,70
EC7-5	3/4"	9	23	66,10
EC7-6	1"	11	25	108,00

Støjreduktion >20dB

Lyddæmper LANG MODEL

MESSING / BRONZE - BSPT



Varenr.	BSPT	L1	L total	DKK
EC8-7	M5	14	18	16,45
EC8-1	1/8"	21	27	15,70
EC8-2	1/4"	24	32	21,75
EC8-3	3/8"	32	40	41,95
EC8-4	1/2"	37	47	53,30
EC8-5	3/4"	43	53	109,00
EC8-6	1"	55	65	163,00

Støjreduktion >20dB

Lyddæmper LANG MODEL

MESSING / BRONZE - BSPT



Varenr.	BSPT	L1	L total	DKK
EC9-1	1/8"	36	42	23,40
EC9-2	1/4"	40	47	31,50
EC9-3	3/8"	44	52	56,50
EC9-4	1/2"	57	67	79,75
EC9-5	3/4"	64	74	144,00
EC9-6	1"	79	89	232,25

Støjreduktion >20dB

Lyddæmper med slangestuds

MESSING / BRONZE



Varenr.	Ø/ø	L1	L total	DKK
EC21-1	4/2,5	15,5	32	13,35
EC21-2	5/3	18	37	18,10
EC21-3	6/4	18	37	18,10
EC21-4	8/6	25	44	28,15

Støjreduktion >20dB

Lyddæmper LANG MODEL

MESSING / BRONZE - BSPP



Varenr.	BSPP	L1	L total	DKK
EC8F-8	1/8"	20	26	21,50

Støjreduktion >20dB

Lyddæmper LANG MODEL

MESSING - BSPT



Varenr.	BSPT	L1	L total	DKK
EC15-1	3/4"	200	212	1690,25
EC15-2	1"	200	214	1690,25
EC15-3	1 1/4"	200	215	1690,25
EC15-4	1 1/2"	200	217	1690,25
EC15-5	2"	200	219	2131,25

Støjreduktion >20dB

Lyddæmper med slangestuds

AISI 316 - BSPT



Varenr.	Ø	L1	L max	DKK
EC37-1	6	39,5	54,5	184,75
EC37-2	6	64	79,5	256,00

Støjreduktion >20dB

Lyddæmper PLAST

PE (POLYETHYLEN) - BSPT



M5 og 1/8" = POM

Flow ved 6 bar:

M5 = 280 L/min, 1/8" = 1450 L/min

1/4" = 2600 L/min, 3/8" = 5050 L/min

1/2" = 8640 L/min

Varenr.	BSPT	L1	L total	DKK
EC30-7	M5	13	18	5,30
EC30-1	1/8"	33	40	7,20
EC30-2	1/4"	54,5	64,5	14,45
EC30-3	3/8"	72	85	21,65
EC30-4	1/2"	80	94	30,35
EC30-5	3/4"	99	115	139,75
EC30-6	1"	100	117	136,75

Max 10bar. Støjreduktion >30dB

Lyddæmper PLAST

PE (POLYETHYLEN) - BSPT



M5 og 1/8" = POM

Flow ved 6 bar:

M5 = 280 L/min, 1/8" = 1450 L/min

1/4" = 2600 L/min, 3/8" = 5050 L/min

1/2" = 8640 L/min

Varenr.	BSPT	L1	L total	DKK
EC31-7	M5	13	18	5,30
EC31-1	1/8"	33	40	7,60
EC31-2	1/4"	54,5	64,5	14,45
EC31-3	3/8"	72	85	22,70
EC31-4	1/2"	80	94	30,35
EC31-5	3/4"	99	115	139,75
EC31-6	1"	100	117	143,50

Max 10bar. Støjreduktion >30dB

Lyddæmper PLAST

PA (POLYAMID) / AISI 304 - BSPT



Varenr.	BSPT	L1	L total	DKK
EC20-1	1/8"	9	15	9,55
EC20-2	1/4"	11	18	13,35
EC20-3	3/8"	12	20	22,50
EC20-4	1/2"	12	22	31,20

Max 6bar. Støjreduktion >20dB

Lyddæmper PLAST

POM (ACETAL) - BSPT



Varenr.	BSPT	L1	L total	DKK
EC10-1	1/8"	26,5	32,5	15,85
EC10-2	1/4"	35	43	19,00
EC10-3	3/8"	47	58	38,90
EC10-4	1/2"	47	58	38,90
EC10-5	3/4"	97	115	150,25
EC10-6	1"	97	115	150,25

Max 6bar. Støjreduktion >20dB

Lyddæmper PLAST

POM (ACETAL) - BSPT



Varenr.	BSPT	L1	L total	DKK
EC11-1	1/8"	28	34	15,85
EC11-2	1/4"	36	44	19,00
EC11-3	3/8"	47	56	38,90
EC11-4	1/2"	47	56	38,90

Max 6bar. Støjreduktion >20dB

Lyddæmper PLAST

PE (POLYETHYLEN) - BSPT



Varenr.	Dim	L1	L total	DKK
EC22-0	M5	21	25	6,35
EC22-1	1/8"	27,5	33,5	8,45
EC22-2	1/4"	33	42	13,50
EC22-3	3/8"	56	66	28,15
EC22-4	1/2"	62	75	31,20
EC22-5	3/4"	126	138,5	89,00
EC22-6	1"	140	160	151,50

Max 10bar. Støjreduktion >20dB

Drøvløse lyddæmper

PE (POLYETHYLEN) - BSPT



Varenr.	BSPT	L1	L total	DKK
EC25-1	1/8"	14	20	21,15
EC25-2	1/4"	23	29	26,45
EC25-3	3/8"	31	38	33,90
EC25-4	1/2"	42	49,5	45,75

Max 10bar. Støjreduktion >20dB

Drøvløse lyddæmper / PE

MESSING - BSPT



Varenr.	BSPT	L1	L total	DKK
EC26-1	1/8"	24	31	45,25
EC26-2	1/4"	31,5	40	64,20
EC26-3	3/8"	39	47,5	113,50
EC26-4	1/2"	46,5	58	218,75
EC26-5	3/4"	56	71	354,50
EC26-6	1"			452,50

Støjreduktion >20dB

Drøvle lydæmper

MESSING - BSPT



Varenr.	BSPT	L1	L max	DKK
EC12-1	1/8"	22	28	34,20
EC12-2	1/4"	24	32	37,85
EC12-3	3/8"	28	38	63,65
EC12-4	1/2"	29	40	66,60
EC12-5	3/4"	37	49	169,00
EC12-6	1"	37	49	245,25

Støjreduktion >20dB

Drøvle lydæmper

MESSING - BSPT



Varenr.	BSPT	L1	L max	DKK
EC33-1	1/8"	25	31,5	42,75
EC33-2	1/4"	27,5	36	58,75
EC33-3	3/8"	32	42	82,15
EC33-4	1/2"	33,5	44	128,00
EC33-5	3/4"	41,5	55	213,50
EC33-6	1"	50	65,5	352,75

Støjreduktion >20dB

Drøvle lydæmper

MESSING - BSPT



Varenr.	BSPT	L1	L total	DKK
EC28-1	1/8"	18,5	26,5	37,25
EC28-2	1/4"	22	29,5	52,95
EC28-3	3/8"	25	35	86,30
EC28-4	1/2"	33	45	147,25

Støjreduktion >20dB

Drøvle lydæmper

MESSING - BSPT



Varenr.	BSPT	L1	L max	DKK
EC13-7	M5	18	21	62,55
EC13-1	1/8"	36	44	57,90
EC13-2	1/4"	36	45	59,00
EC13-3	3/8"	50	60	114,00
EC13-4	1/2"	50	61	117,75
EC13-5	3/4"	80	92	226,25
EC13-6	1"	80	92	326,50

Støjreduktion >20dB

Drøvle lydæmper

MESSING - BSPT



Varenr.	BSPT	L1	L max	DKK
EC35-1	1/8"	28,5	35,5	53,55
EC35-2	1/4"	34,5	43,5	74,80
EC35-3	3/8"	36	45,5	117,50
EC35-4	1/2"	45	56	171,00
EC35-5	3/4"	51,5	65	267,25
EC35-6	1"	65,5	79,5	427,00

Støjreduktion >20dB

Drøvle lydæmper

AISI 304 - BSPT



Varenr.	BSPT	L1	L total	DKK
EC27-1	1/8"	24	30,5	165,50
EC27-2	1/4"	28	37	210,75
EC27-3	3/8"	29	39	271,75
EC27-4	1/2"	34	45	362,00
EC27-5	3/4"	40	52	452,50
EC27-6	1"			724,00

Støjreduktion >20dB

Drøvle lydæmper

MESSING - BSPT



Varenr.	BSPT	L1	L max	DKK
EC34-1	1/8"	27,2	34,2	41,10
EC34-2	1/4"	29	38,5	55,45
EC34-3	3/8"	33,5	44	80,00
EC34-4	1/2"	36,5	48,5	128,00
EC34-5	3/4"	45,5	60	235,25
EC34-6	1"	54	70	352,75

Støjreduktion >20dB

Drøvle lydæmper

MESSING - BSPT



Varenr.	BSPT	L1	L max	DKK
EC36-1	1/8"	27	34	38,60
EC36-2	1/4"	27,5	37	57,35
EC36-3	3/8"	37,5	48	85,45
EC36-4	1/2"	46,5	58,5	138,75
EC36-5	3/4"	54	66	254,75
EC36-6	1"	66	80,5	331,00

Støjreduktion >20dB

Lyddæmper "flet" RUSTFRI

AISI 304 - BSPT



Varenr.	BSPT	L1	L total	DKK
EC18-7	M5			60,90
EC18-1	1/8"	23	29	83,00
EC18-2	1/4"	25	32	105,25
EC18-3	3/8"	32	40	149,00
EC18-4	1/2"	36	45	235,00

Støjreduktion >20dB

Lyddæmper

ALUMINIUM - BSPT



Varenr.	BSPT	L	øD	DKK
EC54-1	1/8"	42,5	20,5	57,85
EC54-2	1/4"	45	20,5	57,85
EC54-3	3/8"	79,5	31,5	123,00
EC54-4	1/2"	81	31,5	123,00
EC54-5	3/4"	108,5	51	361,50
EC54-6	1"	111	51	361,50

Lyddæmper "Inline"

MESSING / AISI 316 - BSPT



Både udvendigt og indvendigt gevind

Varenr.	Str.	DKK
EC14-1	1/8"	75,10
EC14-2	1/4"	90,35
EC14-3	3/8"	104,25
EC14-4	1/2"	122,00

Støjreduktion >20dB

Lyddæmper "sinter" RUSTFRI

AISI 304 - BSPT



Varenr.	BSPT	L1	L total	DKK
EC32-0	M5	16	21	37,50
EC32-1	1/8"	21,5	28,5	50,20
EC32-2	1/4"	24	33,5	76,20
EC32-3	3/8"	30	40,5	112,50
EC32-4	1/2"	39	50,5	175,50
EC32-5	3/4"	47	59	292,50
EC32-6	1"	56	71	459,50

Støjreduktion >20dB

Lyddæmper

STÅL - BSPT



Varenr.	BSPT	L1	L total	DKK
EC23-1	1/8"	28	28	45,25
EC23-2	1/4"	34	43,5	60,35
EC23-3	3/8"	40	50,5	75,35
EC23-4	1/2"	54	66	128,25
EC23-5	3/4"	62	74	162,25
EC23-6	1"	75,5	90	264,25
EC23-7	1 1/4"	91	106	905,00 α
EC23-8	1 1/2"	101,5	116,5	1131,00 α
EC23-9	2"	114	130,5	1507,00 α

Støjreduktion >20dB, α = >25dB

Lyddæmper "Inline"

ALUMINIUM - BSPT



Varenr.	BSPT	L	NV	DKK
EC55-1	M14x1	81	38,1	361,50

NV = nøglevidde

PNEUMATIK & LUFTBEHANDLING

Lyddæmper

ALUMINIUM - BSPT



Varenr.	BSPT	L1	L total	DKK
EC24-1	1/8"	28	28	52,45
EC24-2	1/4"	34	43,5	75,35
EC24-3	3/8"	40	50,5	113,25
EC24-4	1/2"	54	66	188,50
EC24-5	3/4"	62	74	301,75

Støjreduktion >20dB

Lyddæmper "Inline"

ALUMINIUM - BSPT



Varenr.	BSPT	L	NV	DKK
EC52-1	1/8"	58,8	19	86,70
EC52-2	1/4"	58,8	19	108,50

NV = nøglevidde

Lyddæmper STOR

ALUMINIUM - BSPT



Varenr.	BSPT	L1	L total	DKK
EC16-1	1/8"	70	80	367,50
EC16-2	1/4"	93	106	439,50
EC16-3	3/8"	113	126	663,00
EC16-4	1/2"	132	146	463,25
EC16-5	3/4"	162	179	551,25
EC16-6	1"	192	219	838,50
EC16-7	1 1/4"	192	219	1471,00 α
EC16-8	1 1/2"	318	351	1720,25 α
EC16-9	2"	450	484	3058,25 α

Støjreduktion >20dB, α = >25dB

LAD OS HØRE FRA DIG

ROYKON AS har bred erfaring i levering af specialkomponenter i rustfri og messing. Vi kan tilbyde serier fra 100 til mange 100.000 enheder.

De fabrikker, vi får produceret på, besøges i gennemsnit en gang om året. Vi har igennem årene haft et langt udskillelsesløb, hvor de fabrikker, vi bruger i dag, er fabrikker med meget høje standarder og kvalitetskrav.

Vi tilbyder at give en hurtig pris på dine specialkomponenter og på pro-

duktionssiden betyder det, at vi i udviklingsfasen har lynhurtig tilbagemelding og at kvaliteten af produkterne er, som vores kunder har specificeret.

Vores leverandører er miljøbeviste, benytter ikke børnearbejde og har ordnede forhold for alle medarbejdere.

Således føler vi os nu rustet til at levere kvalitetsfittings til virksomheder, for hvem kvalitet er en selvfølge og hvor miljø og social bevidsthed har betydning.

**RING FOR ET
UFORPLIGTENDE
BESØG PÅ TELEFON:**

75 945 955



CYLINDRE



Cylindre fra Aignep er produceret efter strenge kvalitetskrav og serien udbygges til stadighed.

Cylinder enkeltvirk.

STÅL - MM

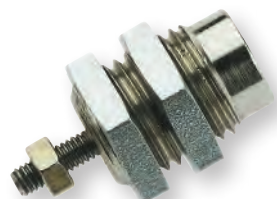

Varenr.	Ø	S	C	DKK
EA1-1	6	5	M5	149,75
EA1-2	6	10	M5	154,50
EA1-3	6	15	M5	159,00
EA1-4	10	5	M5	159,00
EA1-5	10	10	M5	164,25
EA1-6	10	15	M5	168,00
EA1-7	16	5	M5	179,25
EA1-8	16	10	M5	185,25
EA1-9	16	15	M5	191,50

S = slaglængde, C = tilslutning

A	Ø	B	C	D	E	F	5	10	15	H	M	CH
M10x1,0	6	8,5	M5	M3	9	5	18,5	25,5	32,5	9,0	3	14
M15x1,5	10	13	M5	M4	14	5	20,5	27,0	34,0	11,5	4	19
M22x1,5	16	19	M5	M5	20	6	23,5	29,5	36,0	14,0	5	27

SPECIFICATION EA1

Body: Nickel plated brass

Stem: AISI 303

Seals: NBR

Nut: Zink-coated steel

Spring: Steel

Operating press: Min 2 bar, max 7 bar

Temp.: -20°C +80°C

Media: Filtrated compressed air

NB: Use only clean air and avoid side-wise impact on the stem. Avoid impacting stem during spring pull-back. Avoid cylinder action at larger inertia.

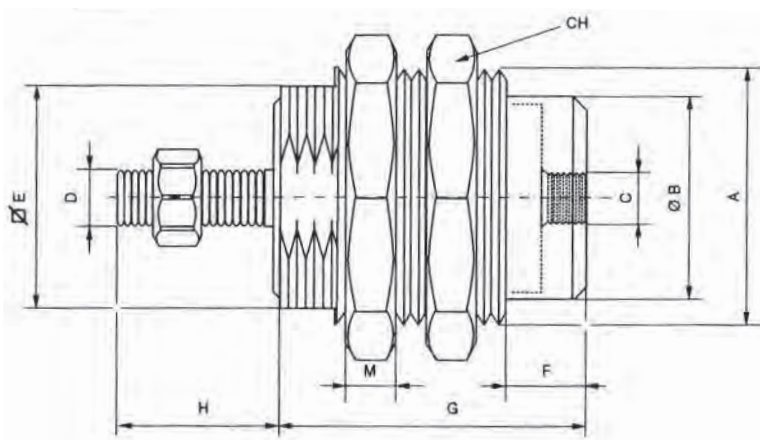

Ø	A	C	D	E	F	G	K	A1	B	L	M	N	P	R	CH
8	M4	8	16	4	12	M5	16	4	M12x1,25	12	86	6	46	64	-
10	M4	8	16	4	12	M5	16	4	M12x1,25	12	86	6	46	64	-
12	M6	12	19	6	16	M5	22	6	M16x1,5	18	104	9	48	75	5
16	M6	12	19	6	16	M5	22	6	M16x1,5	18	109	9	53	82	5
20	M8	16	27	8	20	1/8G	24	8	M22x1,5	20	131	12	67	95	7
25	M10x1,25	16	30	8	20	1/8G	28	10	M22x1,5	22	140	12	68	104	9

SPECIFIKATION EA2

Cylinderrør: AISI 304
Endebunde: Anodiseret aluminium
Stempelstang: Messing
Pakninger: NBR
Arbejdstryk: Max 10 bar
Temp.: -20°C +80°C
Medie: Filtreret trykluft, smurt eller usmurt

VIGTIGT:

Brug kun ren luft, undgå sidebelastning på stempelstang. Undgå at belaste stempelstang under fjedertilbagetrækning. Undgå igangsætning af cylindre ved større inerti.

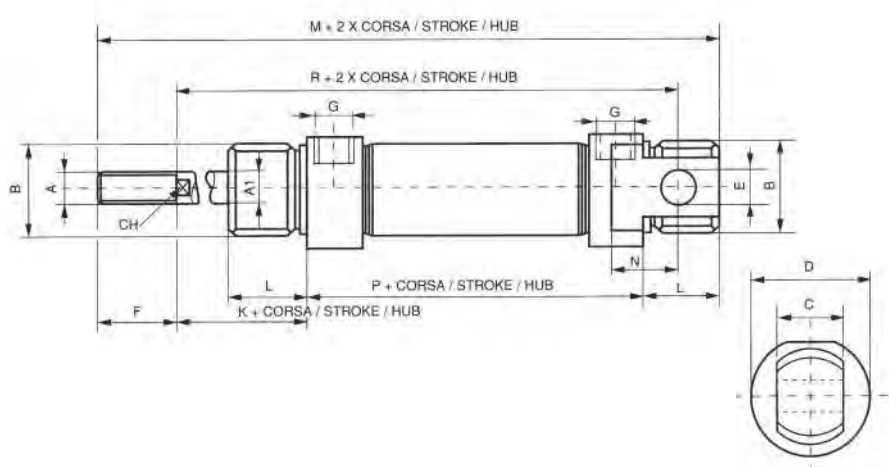

Cylinder enkeltvirkende

STÅL - MM×BSPP

ISO 6432, magnetisk

Varenr.	Ø	S	G	DKK
EA2-1	8	10	M5	384,00
EA2-2	8	25	M5	402,75
EA2-3	8	50	M5	422,25
EA2-4	10	10	M5	386,25
EA2-5	10	25	M5	405,50
EA2-6	10	50	M5	424,75
EA2-7	12	10	M5	411,25
EA2-8	12	25	M5	424,75
EA2-9	12	50	M5	437,25
EA2-10	16	10	M5	432,75
EA2-11	16	25	M5	443,00
EA2-12	16	50	M5	460,00
EA2-13	20	10	1/8"	449,50
EA2-14	20	25	1/8"	460,00
EA2-15	20	50	1/8"	478,00
EA2-16	25	10	1/8"	503,00
EA2-17	25	25	1/8"	513,75
EA2-18	25	50	1/8"	528,75

S = slaglængde, G = tilslutning

Ø	A	C	D	E	F	G	K	A1	B	L	M	N	P	R	CH
8	M4	8	16	4	12	M5	16	4	M12x1,25	12	86	6	46	64	-
10	M4	8	16	4	12	M5	16	4	M12x1,25	12	86	6	46	64	-
12	M6	12	19	6	16	M5	22	6	M16x1,5	18	104	9	48	75	5
16	M6	12	19	6	16	M5	22	6	M16x1,5	18	109	9	53	82	5
20	M8	16	27	8	20	1/8G	24	8	M22x1,5	20	131	12	67	95	7
25	M10x1,25	16	30	8	20	1/8G	28	10	M22x1,5	22	140	12	68	104	9

SPECIFIKATION EA3

Cylinderrør: AISI 304
Endebunde: Anodiseret aluminium
Stempelstang: Messing
Pakninger: NBR
Arbejdstryk: Max 10 bar
Temp.: -20°C +80°C
Medie: Filtret trykluft, smurt eller usmurt

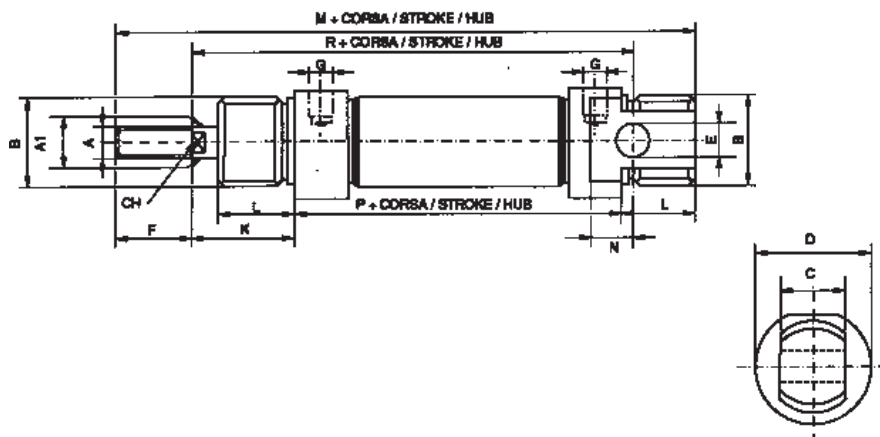

VIGTIGT:

Brug kun ren luft, undgå sidebelastning på stempelstang. Undgå at belaste stempelstang under fjedertilbagetrækning. Undgå igangsætning af cylindre ved større inerti.



Cylinder dobbeltvirkende

STÅL - MMxBSPP

ISO 6432, magnetisk

Varenr.	Ø	S	G	DKK
EA3-1	8	10	M5	386,25
EA3-2	8	25	M5	405,25
EA3-3	8	50	M5	423,50
EA3-4	8	80	M5	433,75
EA3-5	8	100	M5	444,75
EA3-6	8	125	M5	462,25
EA3-7	10	10	M5	388,00
EA3-8	10	25	M5	407,75
EA3-9	10	50	M5	427,50
EA3-10	10	80	M5	436,25
EA3-11	10	100	M5	447,00
EA3-12	10	125	M5	467,00
EA3-13	12	10	M5	412,75
EA3-14	12	25	M5	421,25
EA3-15	12	50	M5	438,75
EA3-16	12	80	M5	448,50
EA3-17	12	100	M5	465,25
EA3-18	12	125	M5	476,75
EA3-19	12	160	M5	484,75
EA3-20	12	200	M5	503,00
EA3-21	16	10	M5	433,75
EA3-22	16	25	M5	444,75
EA3-23	16	50	M5	462,25
EA3-24	16	80	M5	481,25
EA3-25	16	100	M5	490,50
EA3-26	16	125	M5	496,50
EA3-27	16	160	M5	525,25
EA3-28	16	200	M5	542,50
EA3-29	16	250	M5	563,50
EA3-30	20	10	1/8"	451,00
EA3-31	20	25	1/8"	462,25
EA3-32	20	50	1/8"	481,25
EA3-33	20	80	1/8"	505,25
EA3-34	20	100	1/8"	526,75
EA3-35	20	125	1/8"	534,75
EA3-36	20	160	1/8"	551,50
EA3-37	20	200	1/8"	588,00
EA3-38	20	250	1/8"	623,75
EA3-39	20	320	1/8"	658,75
EA3-40	25	10	1/8"	505,25
EA3-41	25	25	1/8"	515,00
EA3-42	25	50	1/8"	531,25
EA3-43	25	80	1/8"	551,50
EA3-44	25	100	1/8"	559,75
EA3-45	25	125	1/8"	588,00
EA3-46	25	160	1/8"	611,50
EA3-47	25	200	1/8"	651,00
EA3-48	25	250	1/8"	694,25
EA3-49	25	320	1/8"	751,50

S = slaglængde, G = tilslutning

Flange STÅL

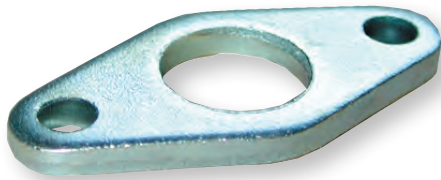

Varenr.	Cyl. Ø	O	DKK
EA6-1-1	8-10	Ø12	21,05
EA6-1-3	12-16	Ø16	25,30
EA6-1-5	20-25	Ø22	38,10

O = hul dim.

Fodbeslag STÅL

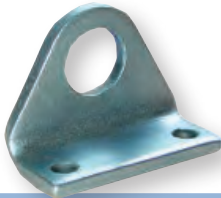

Varenr.	Cyl. Ø	O	DKK
EA6-2-1	8-10	Ø12	21,05
EA6-2-3	12-16	Ø16	27,25
EA6-2-5	20-25	Ø22	40,00

O = hul dim.

Drejebeslag STÅL



Varenr.	Cyl. Ø	O	DKK
EA6-3-1	8-10	Ø4	34,75
EA6-3-3	12-16	Ø6	41,95
EA6-3-5	20-25	Ø8	50,50

O = aksel dim.

Gaffel til stempelstang STÅL - MM



Varenr.	Cyl. Ø	Int. dim	O	DKK
EA6-5-1	8-10	M4	Ø4	32,30
EA6-5-3	12-16	M6	Ø6	26,00
EA6-5-5	20	M8	Ø8	30,35
EA6-5-6	25-32	M10*1,25	Ø10	41,70

O = aksel dim.

Kontramøtrik STÅL - MM

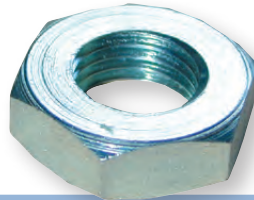

Varenr.	Cyl. Ø	Int. dim	DKK
EA6-4-1	8-10	M12*1,25	9,50 x
EA6-4-3	12-16	M16*1,5	11,55 x
EA6-4-5	20-25	M22*1,5	15,75 x
EA6-4-7	8-10	M4	0,56 x
EA6-4-9	12-16	M6	0,83 x
EA6-4-11	20	M8*1,25	2,65 x
EA6-4-12	25	M10*1,25	3,14 x

x = til krop, x = til stang

Kugleled STÅL - MM

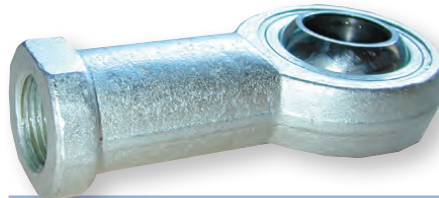

Varenr.	Cyl. Ø	Int. dim	O	DKK
EA6-6-1	8-10	M4*0,7	Ø5	162,75
EA6-6-3	12-16	M6*1	Ø6	203,50
EA6-6-5	20	M8*1,25	Ø8	210,00
EA6-6-6	25-32	M10*1,25	Ø10	312,25

O = hul dim.

Montageclips



Varenr.	Cyl. Ø	Ø	DKK
EA13-1	8	9,4	33,10
EA13-2	10	11,3	33,10
EA13-3	12	13,3	33,10
EA13-4	16	17,3	33,10
EA13-5	20	21,3	33,10
EA13-6	25	26,3	33,10

Signalkabel



Varenr.	Str.	DKK
EA11-1	-	400,00

CYLINDRE RUSTFRI



Rustfri cylindre fra Aignep er produceret efter strenge kvalitetskrav og serien udbygges til stadighed.



Cylinder dobbeltvirk.

AISI 316 / 304 - MM×BSPP

ISO 6432, magnetisk

Varenr.	Ø	S	G	DKK
EA5-21	16	10	M5	1172,25
EA5-22	16	25	M5	1168,25
EA5-23	16	50	M5	1182,50
EA5-24	16	80	M5	1197,00
EA5-25	16	100	M5	1207,25
EA5-26	16	125	M5	1220,75
EA5-27	16	160	M5	1245,50
EA5-28	16	200	M5	1267,00
EA5-29	16	250	M5	1292,75
EA5-30	20	10	1/8"	1335,00
EA5-31	20	25	1/8"	1341,25
EA5-32	20	50	1/8"	1357,75
EA5-33	20	80	1/8"	1376,25
EA5-34	20	100	1/8"	1386,50
EA5-35	20	125	1/8"	1401,00
EA5-36	20	160	1/8"	1431,75
EA5-37	20	200	1/8"	1454,50
EA5-38	20	250	1/8"	1485,50
EA5-39	20	320	1/8"	1525,50
EA5-40	25	10	1/8"	1413,25
EA5-41	25	25	1/8"	1427,75
EA5-42	25	50	1/8"	1448,25
EA5-43	25	80	1/8"	1475,00
EA5-44	25	100	1/8"	1491,50
EA5-45	25	125	1/8"	1513,25
EA5-46	25	160	1/8"	1555,50
EA5-47	25	200	1/8"	1588,50
EA5-48	25	250	1/8"	1630,50
EA5-49	25	320	1/8"	1692,50

S = slaglængde, G = tilslutning

Ø	A	C	D	E	F	G	K	A1	B	L	M	N	P	R	CH
8	M4	8	16	4	12	M5	16	4	M12x1,25	12	86	6	46	64	-
10	M4	8	16	4	12	M5	16	4	M12x1,25	12	86	6	46	64	-
12	M6	12	19	6	16	M5	22	6	M16x1,5	18	104	9	48	75	5
16	M6	12	19	6	16	M5	22	6	M16x1,5	18	109	9	53	82	5
20	M8	16	27	8	20	1/8G	24	8	M22x1,5	20	131	12	67	95	7
25	M10x1,25	16	30	8	20	1/8G	28	10	M22x1,5	22	140	12	68	104	9

SPECIFIKATION EA5

Cylinderrør: AISI 304
Endebunde: AISI 316
Stempelstang: AISI 316
Pakninger: NBR
Arbejdstryk: Max 10 bar
Temp.: -20°C +80°C
Medie: Filtreret trykluft, smurt eller usmurt

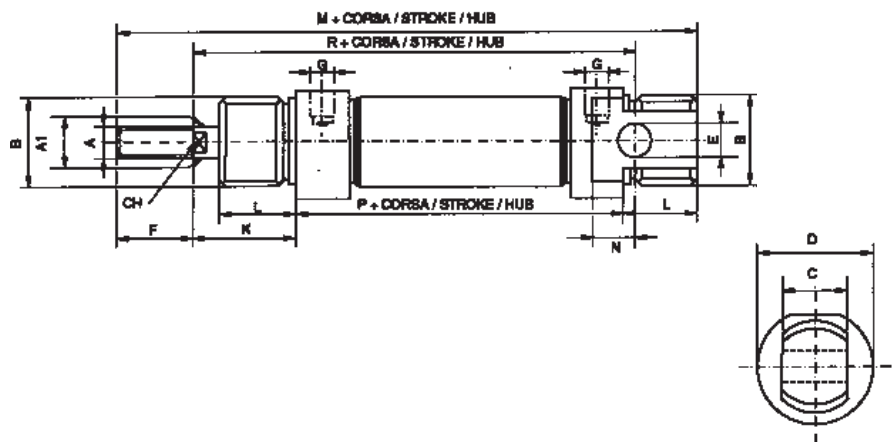

VIGTIGT:

Brug kun ren luft, undgå sidebelastning på stempelstang. Undgå at belaste stempelstang under fjedertilbagetrækning. Undgå igangsætning af cylindre ved større inerti.

Flange

AISI 316

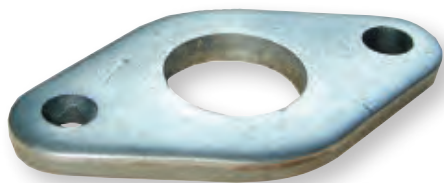

Varenr.	Cyl. Ø	O	DKK
EA7-1	16	Ø16	75,90
EA7-2	20-25	Ø22	131,25

O = hul dim.

Drejebeslag

AISI 316



Varenr.	Cyl. Ø	O	DKK
EA9-1	16	Ø6	121,25
EA9-2	20-25	Ø8	177,00

O = aksel dim.

Montageclips



Varenr.	Cyl. Ø	Ø	DKK
EA13-1	8	9,4	33,10
EA13-2	10	11,3	33,10
EA13-3	12	13,3	33,10
EA13-4	16	17,3	33,10
EA13-5	20	21,3	33,10
EA13-6	25	26,3	33,10

Fodbeslag

AISI 316

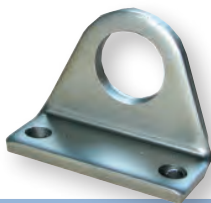

Varenr.	Cyl. Ø	O	DKK
EA8-1	16	Ø16	82,75
EA8-2	20-25	Ø22	152,00

O = hul dim.

Kontramøtrik

AISI 316 - MM

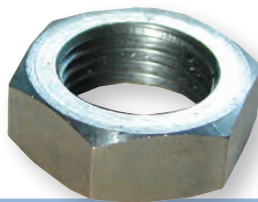

Varenr.	Cyl. Ø	Int. dim	DKK
EA10-1	16	M16*1,5	44,40 x
EA10-2	20-25	M22*1,5	57,90 x
EA10-4	16	M6	0,83 x
EA10-5	20	M8*1,25	4,62 x
EA10-6	25	M10*1,25	19,40 x

x = til krop, x = til stang

CYLINDRE ALUMINIUM



Aluminium cylindre fra Aignep er produceret efter strenge kvalitetskrav og serien udbygges til stadighed.

Ø	A	B	D	E	F	G	L	R	AM	BG	EE	KK	SW	VA	VD	WH
32	12	30	M6	47	48	28	94	32,5	22	16	1/8G	M10x1,25	10	4	20	26
40	16	35	M6	53	54	31,5	106	38	24	16	1/4G	M12x1,25	13	4	22	30
50	20	40	M8	65	69	31,5	106	46,5	32	16	1/4G	M16x1,5	16	4	28	37
63	20	45	M8	75	69	35	121	56,5	32	16	3/8G	M16x1,5	16	4	28	37
80	25	45	M10	95	86	36	128	72	40	16	3/8G	M20x1,5	21	4	34	46
100	25	55	M10	115	91	41	138	89	40	16	1/2G	M20x1,5	21	4	38	51
125	32	60	M12	140	119	45	160	110	54	20	1/2G	M27x2	27	5	50	65
160	40	65	M16	180	152	49	180	140	72	24	3/4G	M36x2	36		25	80
200	40	75	M16	220	167	49	180	175	72	24	3/4G	M36x2	36		25	95

SPECIFIKATION

Dobbeltvirkende, leveres iflg. ISO 6431, VDMA 24562 og NFE 49-003-1. Polyurethan pakninger for lav friktion og lang levetid. Leveres incl. stempelstangs-møtrik.

Cylinderrør: Anodiseret aluminium

Endebunde: Anodiseret aluminium

Stempelstang: Forkromet stål

Pakninger: Polyurethan

Arbejdstryk: max 10 bar

Temp.: -20°C til +80°C med tør luft

Medie: filtreret trykluft, smurt eller usmurt

VIGTIGT:

Brug kun ren luft, undgå sidebelastning på stempelstang. Undgå at belaste stempelstang under fjedertilbagetrækning. Undgå igangsætning af cylindre ved større inerti.

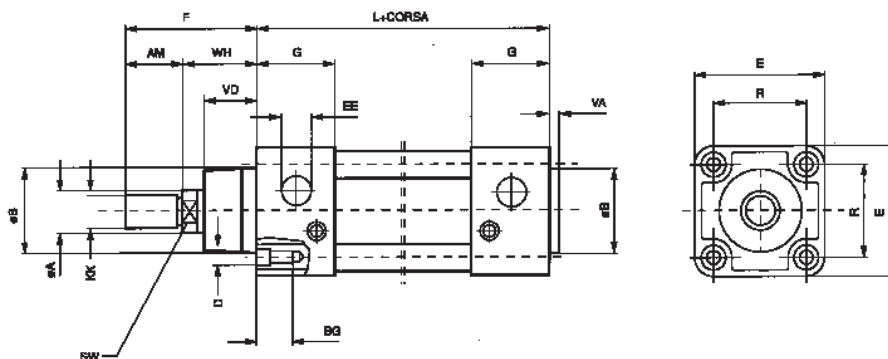



Cylinder dobbeltvirkende

ALUMINIUM - 1/8" BSPP

1/8" tilslutning

ISO 6431, magnetisk			
Varenr.	Ø	S	DKK
EA4-32-25	32	25	846,75
EA4-32-50	32	50	870,00
EA4-32-75	32	75	892,25
EA4-32-100	32	100	919,75
EA4-32-125	32	125	949,75
EA4-32-150	32	150	966,25
EA4-32-200	32	200	1010,50
EA4-32-250	32	250	1133,00
EA4-32-300	32	300	1164,00
EA4-32-350	32	350	1164,00
EA4-32-400	32	400	1197,00
EA4-32-500	32	500	1197,00
EA4-32-800	32	800	1584,25
EA4-32-1000	32	1000	1775,75

S = slaglængde

Cylinder dobbeltvirkende

ALUMINIUM - 1/4" BSPP

1/4" tilslutning

ISO 6431, magnetisk			
Varenr.	Ø	S	DKK
EA4-40-25	40	25	964,50
EA4-40-50	40	50	992,75
EA4-40-75	40	75	1021,75
EA4-40-100	40	100	1050,75
EA4-40-125	40	125	1081,50
EA4-40-150	40	150	1107,25
EA4-40-200	40	200	1162,00
EA4-40-250	40	250	1231,00
EA4-40-300	40	300	1277,25
EA4-40-350	40	350	1277,25
EA4-40-400	40	400	1389,50
EA4-40-600	40	600	1389,50
EA4-40-700	40	700	1389,50
EA4-40-800	40	800	1857,25
EA4-40-1000	40	1000	1857,25
EA4-50-25	50	25	1149,50
EA4-50-50	50	50	1186,75
EA4-50-75	50	75	1223,75
EA4-50-100	50	100	1261,75
EA4-50-125	50	125	1303,00
EA4-50-150	50	150	1336,00
EA4-50-160	50	150	1336,00
EA4-50-200	50	200	1397,75
EA4-50-250	50	250	1453,50
EA4-50-300	50	300	1564,75
EA4-50-350	50	350	1564,75
EA4-50-400	50	400	1685,25
EA4-50-500	50	500	1685,25
EA4-50-800	50	800	2269,25
EA4-50-1000	50	1000	2269,25
EA4-63-25	63	25	1367,00
EA4-63-50	63	50	1406,00

S = slaglængde

Cylinder dobbeltvirkende

ALUMINIUM - 3/8" BSPP

3/8" tilslutning

ISO 6431, magnetisk			
Varenr.	Ø	S	DKK
EA4-63-75	63	75	1445,25
EA4-63-100	63	100	1485,50
EA4-63-125	63	125	1538,00
EA4-63-150	63	150	1563,75
EA4-63-200	63	200	1633,75
EA4-63-250	63	250	1703,75
EA4-63-300	63	300	1826,25
EA4-63-350	63	350	1826,25
EA4-63-400	63	400	1944,75
EA4-63-500	63	500	1944,75
EA4-63-600	63	600	1944,75
EA4-63-800	63	800	2574,00
EA4-63-1000	63	1000	2574,00
EA4-80-25	80	25	1734,75
EA4-80-50	80	50	1789,25
EA4-80-75	80	75	1842,75
EA4-80-100	80	100	1906,75
EA4-80-125	80	125	1964,25
EA4-80-150	80	150	2014,75
EA4-80-200	80	200	2123,00
EA4-80-250	80	250	2237,25
EA4-80-300	80	300	2383,50
EA4-80-350	80	350	2383,50
EA4-80-400	80	400	2561,75
EA4-80-800	80	800	3223,00
EA4-80-1000	80	1000	3878,00

S = slaglængde



Cylinder dobbeltvirkende

ALUMINIUM - 1/2" BSPP
1/2" tilslutning

ISO 6431, magnetisk

Varenr.	Ø	S	DKK
EA4-100-25	100	25	2078,75
EA4-100-50	100	50	2142,50
EA4-100-75	100	75	2211,50
EA4-100-100	100	100	2288,75
EA4-100-125	100	125	2352,75
EA4-100-150	100	150	2415,50
EA4-100-200	100	200	2549,25
EA4-100-250	100	250	2689,50
EA4-100-300	100	300	2872,75
EA4-100-320	100	320	2872,75
EA4-100-350	100	350	2872,75
EA4-100-400	100	400	3095,25
EA4-100-500	100	500	3095,25
EA4-100-800	100	800	4151,00
EA4-100-1000	100	1000	4678,50
EA4-125-25	125	25	3305,50
EA4-125-50	125	50	3381,50
EA4-125-75	125	75	3464,00
EA4-125-100	125	100	3547,50
EA4-125-125	125	125	3629,75
EA4-125-150	125	150	3706,00
EA4-125-200	125	200	3878,00
EA4-125-250	125	250	4049,00
EA4-125-350	125	350	4291,00
EA4-125-400	125	400	4570,25
EA4-125-500	125	500	4570,25
EA4-125-800	125	800	5961,75
EA4-125-1000	125	1000	6662,25

S = slaglængde

For/bagflange

STÅL

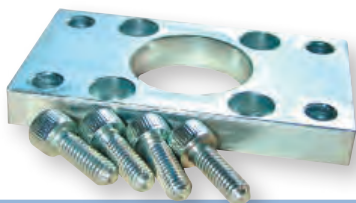

Varenr.	Cyl. Ø	DKK
EA14-1	32	216,50
EA14-2	40	267,25
EA14-3	50	296,50
EA14-4	63	396,75
EA14-5	80	509,00
EA14-6	100	α
EA14-7	125	α

α = spørg på pris

Drejebeslag

ALUMINIUM / STÅL



Varenr.	Cyl. Ø	O dim	DKK
EA17-1	32	ø10	178,25
EA17-2	40	ø12	196,50
EA17-3	50	ø12	225,00
EA17-4	63	ø16	279,00
EA17-5	80	ø16	355,50
EA17-6	100	ø20	α
EA17-7	125	ø25	α

α = spørg på pris

Fodbeslag

STÅL



Varenr.	Cyl. Ø	DKK
EA15-1	32	80,00
EA15-2	40	91,20
EA15-3	50	118,75
EA15-4	63	141,75
EA15-5	80	221,50
EA15-6	100	α
EA15-7	125	α

α = spørg på pris

Drejebeslag

STÅL



Varenr.	Cyl. Ø	O dim	DKK
EA18-1	32	Ø12	668,00
EA18-2	40	Ø16	731,50
EA18-3	50	Ø16	846,25
EA18-4	63	Ø20	1122,75
EA18-5	80	Ø20	1335,00
EA18-6	100	Ø25	α
EA18-7	125	Ø25	α

α = spørg på pris

Drejebeslag

ALUMINIUM / STÅL



Varenr.	Cyl. Ø	O dim	DKK
EA16-1	32	ø10	217,75
EA16-2	40	ø12	250,75
EA16-3	50	ø12	275,75
EA16-4	63	ø16	336,25
EA16-5	80	ø16	428,50
EA16-6	100	ø20	480,50
EA16-7	125	ø25	951,75

α = spørg på pris

Drejebeslag

ALUMINIUM / STÅL



Varenr.	Cyl. Ø	O dim	DKK
EA20-1	32	ø10	169,00
EA20-2	40	ø12	232,25
EA20-3	50	ø12	253,00
EA20-4	63	ø16	369,50
EA20-5	80	ø16	92,45
EA20-6	100	ø20	567,25
EA20-7	125	ø25	656,25

α = spørg på pris

Split STÅL



Varenr.	Cyl. Ø	O dim	L	DKK
EA21-1	32	Ø10	53	34,75
EA21-2	40	Ø12	60	36,70
EA21-3	50	Ø12	68	38,10
EA21-4	63	Ø16	78	51,65
EA21-5	80	Ø16	98	55,45
EA21-6	100	Ø20	118	67,20
EA21-7	125	Ø24	-	¤

¤ = spørg på pris

Signalkabel



Varenr.	Str.	DKK
EA11-1	-	400,00

Gaffel til stempelstang

STÅL - MM



Varenr.	Cyl. Ø	Int. dim	O dim	DKK
EA25-1	25-32	M10*1,25	Ø10	41,70
EA25-2	40	M12*1,25	Ø12	72,10
EA25-3	50-63	M16*1,5	Ø16	147,25
EA25-5	80-100	M20*1,5	Ø20	256,25
EA25-7	125	M27*2	Ø30	305,00

¤ = spørg på pris

Kugleled

STÅL - MM

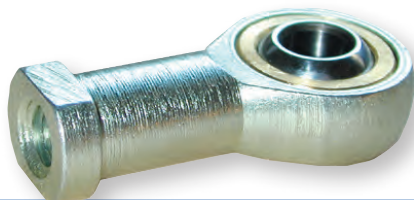

Varenr.	Cyl. Ø	Int. dim	O dim	DKK
EA26-1	25-32	M10*1,25	ø10	312,25
EA26-2	40	M12*1,25	ø12	334,75
EA26-3	50-63	M16*1,5	ø16	542,50
EA26-5	80-100	M20*1,5	ø20	891,75
EA26-7	125	M27*2	ø28	¤

¤ = spørg på pris

DRØVLEVENTILER



Max 10bar



0°C til +80°C



En serie justerbare drøvleventiler, der kan kontrollere mængden af luft ind i et pneumatisk system, enten ensidigt (uni-direktional) eller tosidigt (bi-direktional). At kunne kontrollere luften fra den ene side og frit udblæse fra den anden, gør dem velegnet til pneumatiske cylindre. Den lille størrelse tillader montage direkte på en cylinder, hvilket forhindrer en

evt. elastisk effekt fra en slange og giver en meget præcis regulering af luftmængden på en cylinder.

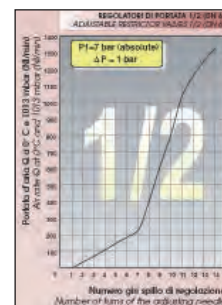
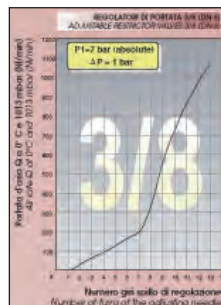
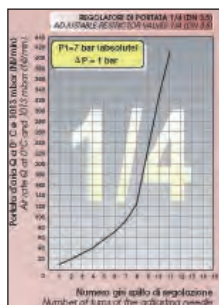
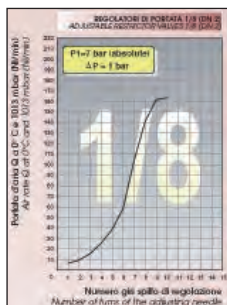
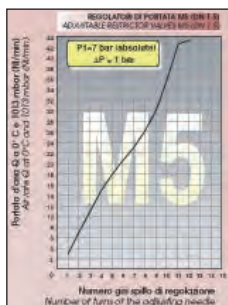

C: uni-direktional cylinder V: uni-direktional ventil B: bi-direktional

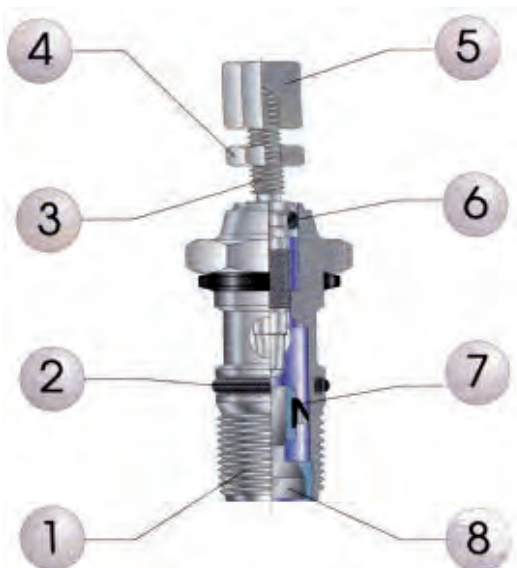

DRØVLEVENTIL EKSPLOSIONSTEGNING

- 1 Forniklet messingkrop
- 2 NBR 70 O-ring
- 3 Forniklet messing justeringsnål
- 4 Forniklet messing låsemøtrik
- 5 Forniklet messing justerings fingerskrue
- 6 NBR 70 O-ring
- 7 NBR 70 læbetætning
- 8 Forniklet messing tætningsanlæg
- 9 PA66 mellemring

Drøvekontraventil

MESSING - BSPP



Til cylinder, skruetrækker reg.

Varenr.	BSPP	Type	DKK
E8952-1	1/8"	3 - C	154,25
E8952-2	1/4"	3 - C	141,25

Drøvekontraventil

MESSING - BSPP



Til ventil, skruetrækker reg.

Varenr.	BSPP	Type	DKK
E8962-1	1/8"	2 - V	154,25
E8962-2	1/4"	2 - V	141,25

Drøveventil

MESSING - BSPP



Skruetrækker regulering

Varenr.	BSPP	Type	DKK
E8972-1	1/8"	1 - B	142,75
E8972-2	1/4"	1 - B	129,00

Drøvekontraventil

MESSING - BSPP



Til cylinder, manuel reg.

Varenr.	BSPP	Type	DKK
E8957-1	1/8"	3 - C	161,50
E8957-2	1/4"	3 - C	147,75

Drøvekontraventil

MESSING - BSPP



Til ventil, manuel reg.

Varenr.	BSPP	Type	DKK
E8967-1	1/8"	2 - V	161,50
E8967-2	1/4"	2 - V	147,75

Drøveventil

MESSING - BSPP



Manuel regulering

Varenr.	BSPP	Type	DKK
E8977-1	1/8"	1 - B	154,25
E8977-2	1/4"	1 - B	137,00

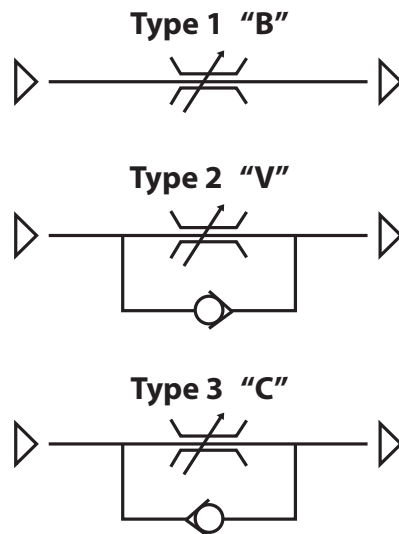

Drøveventil

ALUMINIUM - BSPP



Varenr.	BSPP	Type	DKK
E8860-1	M5	1 - B	130,50
E8860-2	1/8"	1 - B	126,50
E8860-3	1/4"	1 - B	167,50
E8860-4	3/8"	1 - B	340,25
E8860-5	1/2"	1 - B	371,25

Drøvekontraventil

ALUMINIUM - BSPP



Varenr.	BSPP	Type	DKK
E8850-1	M5	2 - V	130,50
E8850-2	1/8"	2 - V	126,50
E8850-3	1/4"	2 - V	167,50
E8850-4	3/8"	2 - V	340,25
E8850-5	1/2"	2 - V	371,25

Drøveventil

ALUMINIUM - BSPP



Varenr.	BSPP	Type	DKK
EC196-1	1/8"	3 - C	138,75
EC196-2	1/4"	3 - C	152,75
EC196-3	3/8"	3 - C	183,75
EC196-4	1/2"	3 - C	259,50

Drøveventil

ALUMINIUM - BSPP



Med hurtigudluft knap

Varenr.	BSPP	Type	DKK
EC197-1	1/8"	3 - C	190,00
EC197-2	1/4"	3 - C	204,75
EC197-3	3/8"	3 - C	237,75
EC197-4	1/2"	3 - C	298,75

EC198K

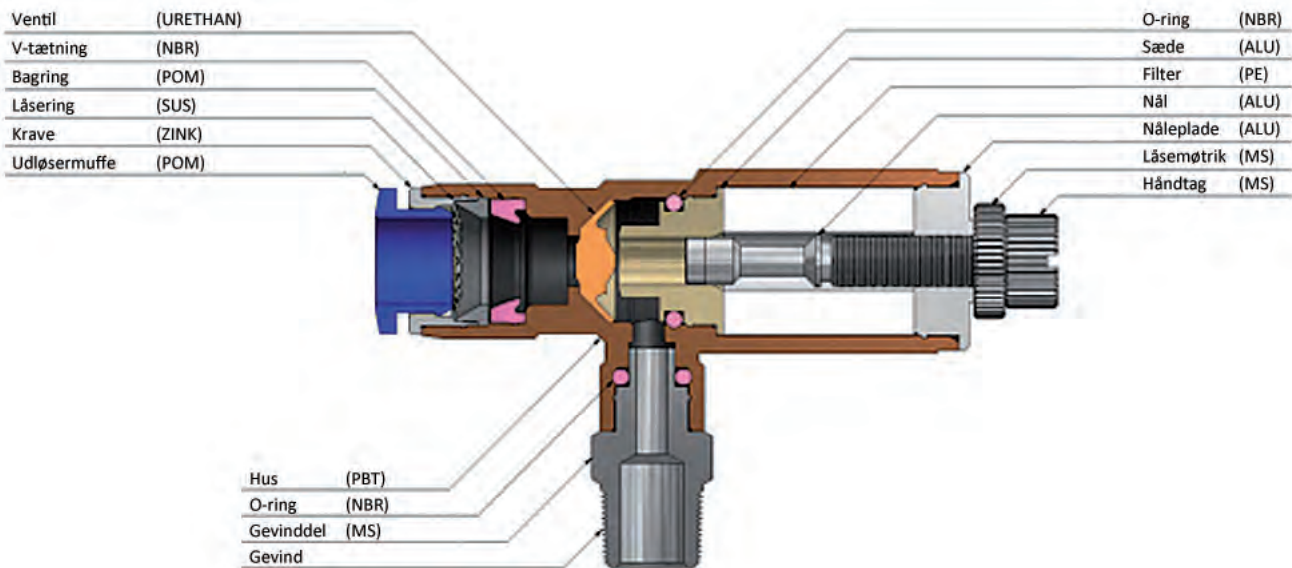

Hurtigudluffer

PBT / MESSING - BSPT



Med drøvfefunktion og lyddæmper

Varenr.	ø × BSPT	DKK
EC198K-0618	ø6×1/8"	131,50
EC198K-0614	ø6×1/4"	138,00
EC198K-0818	ø8×1/8"	138,00
EC198K-0814	ø8×1/4"	142,75
EC198K-0838	ø8×3/8"	175,50
EC198K-1018	ø10×1/8"	171,25
EC198K-1014	ø10×1/4"	178,75
EC198K-1038	ø10×3/8"	180,75
EC198K-1012	ø10×1/2"	239,00
EC198K-1214	ø12×1/4"	230,00
EC198K-1238	ø12×3/8"	228,75
EC198K-1212	ø12×1/2"	240,25

Hurtigudluffer muf/muf

MESSING - BSPP



Varenr.	BSPP	DKK
E6050-0	M5	64,30
E6050-1	1/8"	86,55
E6050-2	1/4"	106,25
E6050-3	3/8"	125,75
E6050-4	1/2"	179,50
E6050-5	3/4"	233,50
E6050-6	1"	230,50

-20° til +80°C. Min 0,3 bar, max 10

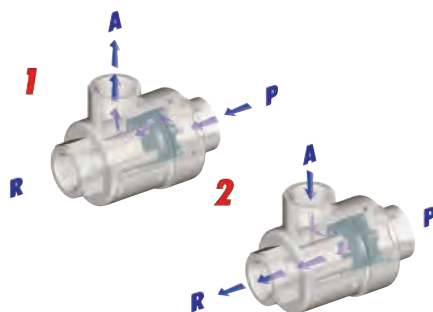

Hurtigudluffer muffe/muffe

AISI 316 - BSPP

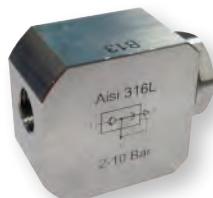

Varenr.	BSPP	DKK
B6050-1	1/8"	1208,75
B6050-2	1/4"	1281,00
B6050-3	3/8"	1557,25
B6050-4	1/2"	1705,25

Drøvfekontraventil 90° muf/nip

AISI 316 - BSPP



Til cylinder, skruetrækker reg.

Varenr.	BSPP	Type	DKK
B8952-1	1/8"	3 - C	1151,00
B8952-2	1/4"	3 - C	1322,00

Drøvfekontraventil muffe/muffe

AISI 316 - BSPP



Til cylinder, finger reg.

Varenr.	BSPP	Type	DKK
B8850-1	1/8"	2 - V	1525,75
B8850-2	1/4"	2 - V	2310,00
B8850-3	3/8"	2 - V	2558,00
B8850-4	1/2"	2 - V	2591,50

FILTER, REGULATOR & SMØREAPPARATER



Driftstryk 0-8 bar. Max 15bar



-10°C til +50°C



Disse apparater fås i 4 forskellige størrelser, hvor mini serien adskiller sig ved andet udseende.

Apparaterne komplementeres også med en meget omfattende tilbehørssamling.

Apparaterne kan opbygges modulært med mange kombinationsmuligheder og gør brug af de nyeste materialer.

SAMLEVEJLEDNING TIL FRS ENHED

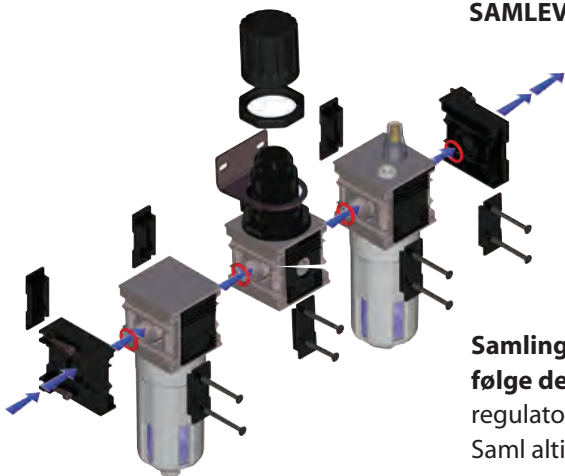

Samling af FRS systemer skal altid følge denne orden: lukkeventil, filter, regulator, smøreapparat. Saml altid emnerne med flowpile i den samme retning, disse forefindes på topfladen af komponenterne.

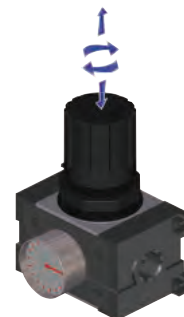

For at regulere trykket udføres følgende: Træk reguleringshåndhjulet opad, regulér altid trykket opad f.eks. fra 4 til 6 bar. Tryk derefter håndhjulet ned for at låse trykket.

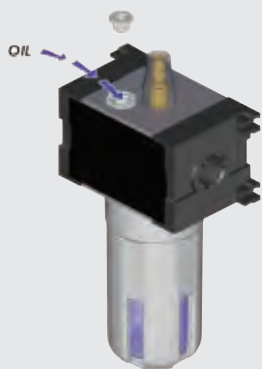

Ved påfyldning af smørelie afmonteres oliepåfyldningsproppen og smørelie påfyldes gennem hullet eller oliebeholderen afmonteres og fyldes. For at regulere mængden af smørelie drejes oliemængderegulatoren med en skruetrækker.



Beholderen kan afmonteres med hånden eller ved brug af sekskantsværktøj. Beholderen har transparente vinduer dette tillader visuel tjek af oliestand eller vandstand i filter.



Ved at dreje på tømmeudslen kan der aftømmes under tryk, ved at dreje modsat uret låses tømmeudslen.

FR+S enhed
PA (POLYAMID) - BSPP



Varenr.	BSPP	dim	L/min	DKK
Serie 1				
E460-1-1	1/8"	198x129	1100	782,50 ☐
E460-2-1	1/4"	198x129	1100	836,75
E460-3-1	3/8"	198x129	1100	836,75
Serie 2				
E460-2-2	1/4"	244,5x159	2500	1212,25 ☐
E460-3-2	3/8"	244,5x159	2500	1212,25 ☐
E460-4-2	1/2"	244,5x159	2500	1212,25
Serie 3				
E460-4-3	1/2"	273x180	4300	1388,25 ☐
E460-5-3	3/4"	273x180	4300	1388,25
E460-6-3	1"	273x180	4300	1388,25

Filter: 20 micron. ☐ = skaffevare

Filter
PA (POLYAMID) - BSPP



Varenr.	BSPP	dim	L/min	DKK
Serie 1				
E460-1-1B	1/8"	146x86	1900	276,50 ☐
E460-2-1B	1/4"	146x86	1900	276,50
E460-3-1B	3/8"	146x86	1900	295,25
Serie 2				
E460-2-2B	1/4"	178,5x104	3750	424,50 ☐
E460-3-2B	3/8"	178,5x104	3750	424,50 ☐
E460-4-2B	1/2"	178,5x104	3750	424,50
Serie 3				
E460-4-3B	1/2"	197,5x115	6250	591,75 ☐
E460-5-3B	3/4"	197,5x115	6250	591,75 ☐
E460-6-3B	1"	197,5x115	6250	591,75

Filter: 20 micron. ☐ = skaffevare

LAGERVARER:

- 1/4" serie1
- 3/8" serie1
- 1/2" serie2
- 1" serie3

Resten:

Regn med 3-4 ugers levering

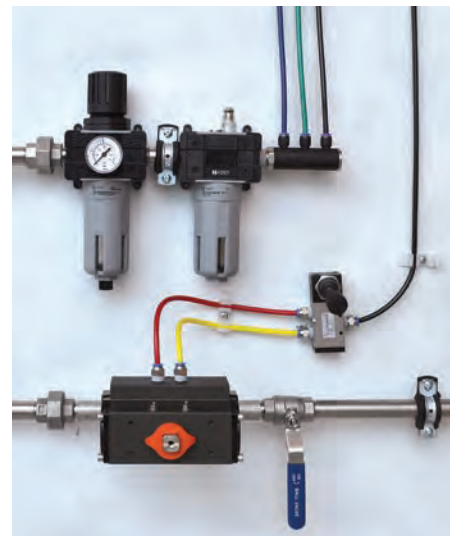

Manometer Ø40
PA (POLYAMID) / STUDS = MESSING



BSPP studs bagud			
Varenr.	BSPP	BAR	DKK
GC7-2	1/8"	0 - 1	120,00
GC7-3	1/8"	0 - 1,6	117,25
GC7-4	1/8"	0 - 2,5	82,50
GC7-5	1/8"	0 - 4	82,50
GC7-6	1/8"	0 - 6	82,50
GC7-6-1/4	1/4"	0 - 6	82,50
GC7-7	1/8"	0 - 10	82,50
GC7-8	1/8"	0 - 12	82,50
GC7-9	1/8"	0 - 16	82,50
GC7-10	1/8"	0 - 20	82,50

Fortætningsfilter
PA (POLYAMID) - BSPP



Varenr.	BSPP	dim	L/min	DKK
Serie 1				
E460-2-1A	1/4"	146x86	700	904,25
E460-3-1A	3/8"	146x86	700	904,25
Serie 2				
E460-3-2A	3/8"	178,5x104	725	1140,75 ☐
E460-4-2A	1/2"	178,5x104	725	1140,75
Serie 3				
E460-5-3A	3/4"	197,5x115	920	1362,00 ☐
E460-6-3A	1"	197,5x115	920	1362,00

Filter: 0,01 micron. ☐ = skaffevare

Trykluftolie
RANDO HD32



Rando HD anbefales til brug i alle typer højtydende industrielle og mobile hydrauliske systemer, der arbejder under moderate omgivelsestemperaturer, høje tryk og pumpehastigheder.

Varenr.	L	DKK
S1010-1	1	156,25
S1010-2	2,5	364,25

Regulator

PA (POLYAMID) - BSPP



Varenr.	BSPP	dim	L/min	DKK
Serie 1				
E460-1-1C	1/8"	97×86	2050	353,50 ☐
E460-2-1C	1/4"	97×86	2050	353,50
E460-3-1C	3/8"	97×86	2050	330,75
Serie 2				
E460-2-2C	1/4"	121×104	3200	485,75 ☐
E460-3-2C	3/8"	121×104	3200	453,50 ☐
E460-4-2C	1/2"	121×104	3200	485,75
Serie 3				
E460-5-3C	3/4"	140,5×115	6200	640,50 ☐
E460-6-3C	1"	140,5×115	6200	684,25

☐ = skaffevare

Filter Regulator

PA (POLYAMID) - BSPP



Varenr.	BSPP	dim	L/min	DKK
Serie 1				
E460-1-1D	1/8"	198×86	1650	483,25 ☐
E460-2-1D	1/4"	198×86	1650	517,75
E460-3-1D	3/8"	198×86	1650	517,75
Serie 2				
E460-2-2D	1/4"	244,5×104	3000	739,75 ☐
E460-3-2D	3/8"	244,5×104	3000	692,50 ☐
E460-4-2D	1/2"	244,5×104	3000	739,75
Serie 3				
E460-4-3D	1/2"	273×115	4500	861,75 ☐
E460-5-3D	3/4"	273×115	4500	861,75 ☐
E460-6-3D	1"	273×115	4500	922,00

Filter: 20 micron. ☐ = skaffevare

Smøreapparat

PA (POLYAMID) - BSPP



Varenr.	BSPP	dim	L/min	DKK
Serie 1				
E460-1-1E	1/8"	162×86	2600	326,00 ☐
E460-2-1E	1/4"	162×86	2600	349,75
E460-3-1E	3/8"	162×86	2600	349,75
Serie 2				
E460-2-2E	1/4"	195×104	5600	498,75 ☐
E460-3-2E	3/8"	195×104	5600	498,75 ☐
E460-4-2E	1/2"	195×104	5600	498,75
Serie 3				
E460-4-3E	1/2"	214×115	8200	608,25 ☐
E460-5-3E	3/4"	214×115	8200	651,00 ☐
E460-6-3E	1"	214×115	8200	552,75

☐ = skaffevare

Shut-off ventil

PA (POLYAMID) - BSPP



Varenr.	BSPP	dim	L/min	DKK
Serie 1				
E460-2-1G	1/4"	105,5×72	1850	754,00
E460-3-1G	3/8"	105,5×72	1850	754,00
Serie 2				
E460-3-2G	3/8"	119,5×89	3000	836,75 ☐
E460-4-2G	1/2"	119,5×89	3000	836,75
Serie 3				
E460-5-3G	3/4"	131,5×100	5200	920,50 ☐
E460-6-3G	1"	131,5×100	5200	920,50

☐ = skaffevare

Filter Regulator m. AUTO aftap

PA (POLYAMID) - BSPP



Varenr.	BSPP	dim	L/min	DKK
Serie 2				
E460-4-2D-A	1/2"	244,5×104	3000	1451,00

Smøreapparat

PE (POLYETHYLEN) - BSPP



Varenr.	BSPP	dim	L/min	DKK
E450-3C	1/4"	167×42	2060	292,25
E450-3D	Samlebeslag 1/4"			13,85
E450-4C	1/2"	227×75	3550	417,00
E450-4D	Samlebeslag 1/2"			24,45

Softstart ventil PA (POLYAMID) - BSPP



Spole bestilles på varenr. E465T-X

Med hurtig udluftning

Varenr.	BSPP	dim	L/min	DKK
Serie 1				
E460-3-1H	3/8"	126,5×115	1850	2917,25
Serie 2				
E460-3-2H	3/8"	142×104	3000	2773,25
E460-4-2H	1/2"	142×104	3000	2773,25
Serie 3				
E460-5-3H	3/4"	131,5×115	5200	3218,75
E460-6-3H	1"	131,5×115	5200	3218,75

¤ = skaffevare

V+FR+S enhed PA (POLYAMID) - BSPP



Varenr.	BSPP	dim	L/min	DKK
Serie 1				
E460-2-1i	1/4"	198×115	800	1579,75
E460-3-1i	3/8"	198×115	800	1579,75
Serie 2				
E460-3-2i	3/8"	244,5×144	2100	2022,00
E460-4-2i	1/2"	244,5×144	2100	2022,00
Serie 3				
E460-5-3i	3/4"	273×165	3500	2309,00
E460-6-3i	1"	273×165	3500	2309,00

Filter: 20 micron. ¤ = skaffevare

F+R+S enhed PA (POLYAMID) - BSPP



Varenr.	BSPP	dim	L/min	DKK
Serie 1				
E460-1-1J	1/8"	198×158	1000	715,75
E460-2-1J	1/4"	198×158	1000	871,25
E460-3-1J	3/8"	198×158	1000	958,50
Serie 2				
E460-3-2J	3/8"	244,5×199	2400	1368,50
E460-4-2J	1/2"	244,5×199	2400	1368,50
Serie 3				
E460-5-3J	3/4"	273×230	4250	1791,00
E460-6-3J	1"	273×230	4250	1791,00

Filter: 20 micron. ¤ = skaffevare

V+F+R+S enhed PA (POLYAMID) - BSPP



Varenr.	BSPP	dim	L/min	DKK
Serie 1				
E460-2-1K	1/4"	198×201	1000	1683,00
E460-3-1K	3/8"	198×201	1000	1683,00
Serie 2				
E460-3-2K	3/8"	244,5×254	2200	2113,25
E460-4-2K	1/2"	244,5×254	2200	2113,25
Serie 3				
E460-5-3K	3/4"	273×295	3900	2649,00
E460-6-3K	1"	273×295	3900	2649,00

Filter: 20 micron. ¤ = skaffevare

F+S enhed PA (POLYAMID) - BSPP



Varenr.	BSPP	dim	L/min	DKK
Serie 1				
E460-2-1L	1/4"	198×201	1350	628,00
E460-3-1L	3/8"	198×201	1350	628,00
Serie 2				
E460-3-2L	3/8"	244,5×254	3200	917,75
E460-4-2L	1/2"	244,5×254	3200	917,75
Serie 3				
E460-5-3L	3/4"	273×295	5000	1162,75
E460-6-3L	1"	273×295	5000	1162,75

Filter: 20 micron. ¤ = skaffevare

Filter+ fortætningsfilter PA (POLYAMID) - BSPP



Varenr.	BSPP	dim	L/min	DKK
Serie 1				
E460-2-1M	1/4"	198×201	370	1155,00
E460-3-1M	3/8"	198×201	370	1155,00
Serie 2				
E460-3-2M	3/8"	244,5×254	600	1511,50
E460-4-2M	1/2"	244,5×254	600	1511,50
Serie 3				
E460-5-3M	3/4"	273×295	910	1905,25
E460-6-3M	1"	273×295	910	1905,25

Filter: 20+0,01 micron. ¤ = skaffevare

LAGERVARER:

- 1/4" serie1
- 3/8" serie1
- 1/2" serie2
- 1" serie3

Resten:
Regn med 3-4 ugers levering

Afspærringsventil

ALUMINIUM - BSPP

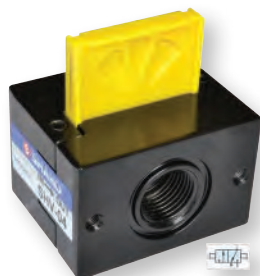

0-60°C, max 8bar.

Til hurtig afspærring af pneumatiske rørstrækninger. Med indbygget udluftning af afspærringssiden, så man kan arbejde uden tryk på den ene side af ventilen og bibeholde tryk på den anden side.

Varenr.	BSPP	DKK
EV22-2	1/4"	176,50
EV22-3	3/8"	176,50
EV22-4	1/2"	176,50

In-line regulator

ALUMINIUM



Temp: -10° til +60°C
Driftstryk: 2 - 8 bar
Max flow 650L/min

Varenr.	BSPP	DKK
E425-2	1/4"	480,50

Mini FR+S enhed

PA (POLYAMID) - BSPP



Varenr.	BSPP	dim	L/min	DKK
E455-1	1/8"	156x80	260	640,50
E455-2	1/4"	156x80	260	640,50

Filter: 20 micron

Mini Regulator

PA (POLYAMID) - BSPP



Varenr.	BSPP	dim	L/min	DKK
E455-1C	1/8"	74x40	600	209,50
E455-2C	1/4"	74x40	600	209,50

Mini fortætningsfilter

PA (POLYAMID) - BSPP



Varenr.	BSPP	dim	DKK
E455-1A	1/8"	109x40	714,25
E455-2A	1/4"	109x40	714,25

Filter: 0,01 micron

Mini hurtigudlifter

PA (POLYAMID) - BSPP



Varenr.	BSPP	dim	L/min	DKK
E455-1G	1/8"	74x40	600	209,50
E455-2G	1/4"	74x40	600	209,50

Mini Filter Regulator

PA (POLYAMID) - BSPP



Varenr.	BSPP	dim	L/min	DKK
E455-1D	1/8"	156x40	600	352,50
E455-2D	1/4"	156x40	600	352,50

Filter: 20 micron

Mini Filter
PA (POLYAMID) - BSPP



Varenr.	BSPP	dim	L/min	DKK
E455-1B	1/8"	109x40	800	204,75
E455-2B	1/4"	109x40	800	204,75

Filter: 20 micron

Mini F+R+S enhed
PA (POLYAMID) - BSPP



Varenr.	BSPP	dim	L/min	DKK
E455-1J	1/8"	156x120	280	715,75
E455-2J	1/4"	156x120	280	715,75

Filter: 20 micron

Forbindelsesstykker



Varenr.	Type	DKK
E465A-0	Mini	10,80
E465A-1	Serie 1	22,95
E465A-2	Serie 2	30,95
E465A-3	Serie 3	33,65

Mini vandregulator
PA (POLYAMID) - BSPP



+5° til +50°C

Varenr.	BSPP	dim	DKK
E455-1H	1/8"	74x40	209,50
E455-2H	1/4"	74x40	209,50

Mini Filter+fortætn.filter
PA (POLYAMID) - BSPP



Varenr.	BSPP	dim	DKK
E455-1M	1/8"	109x80	941,00
E455-2M	1/4"	109x80	941,00

Filter: 20+0,01 micron

Forbindelsessæt



Varenr.	BSPP	Type	DKK
E465B-1-1	1/8"	Serie 1	114,75
E465B-1-2	1/4"	Serie 1	114,75
E465B-1-3	3/8"	Serie 1	114,75
E465B-2-2	1/4"	Serie 2	143,75
E465B-2-3	3/8"	Serie 2	143,75
E465B-2-4	1/2"	Serie 2	143,75
E465B-3-4	1/2"	Serie 3	152,50
E465B-3-5	3/4"	Serie 3	152,50
E465B-3-6	1"	Serie 3	152,50

Mini Smøreapparat
PA (POLYAMID) - BSPP



Varenr.	BSPP	dim	L/min	DKK
E455-1E	1/8"	130x40	700	274,75
E455-2E	1/4"	130x40	700	274,75

Beslag
STÅL



Varenr.	Type	DKK
E460-1-0F	Mini	23,65
E460-1-1F	Serie 1	23,65
E460-2-2F	Serie 2	30,35
E460-4-3F	Serie 3	41,20

Manometer Ø40

PA (POLYAMID) / STUDS = MESSING



BSPP studs bagud

Varenr.	BSPP	BAR	DKK
E465C-1	1/8"	0 - 12	86,30

Membran



Varenr.	Type	DKK
E465D-0	Mini	44,50
E465D-1	Serie 1	53,90
E465D-2	Serie 2	62,10
E465D-3	Serie 3	63,25

Endestykker

ALUMINIUM - BSPP



Varenr.	BSPP	Type	DKK
E465E-1-1	1/8"	Serie 1	67,35
E465E-1-2	1/4"	Serie 1	67,35
E465E-1-3	3/8"	Serie 1	67,35
E465E-2-2	1/4"	Serie 2	81,05
E465E-2-3	3/8"	Serie 2	81,05
E465E-2-4	1/2"	Serie 2	81,05
E465E-3-4	1/2"	Serie 3	83,40
E465E-3-5	3/4"	Serie 3	83,40
E465E-3-6	1"	Serie 3	83,40

Filterelement



Varenr.	my	Type	DKK
E465G-0-1	5	Mini	49,80
E465G-0-2	20	Mini	49,80
E465G-0-3	50	Mini	49,80
E465G-1-1	5	Serie 1	64,75
E465G-1-2	20	Serie 1	64,75
E465G-1-3	50	Serie 1	64,75
E465G-2-1	5	Serie 2	108,25
E465G-2-2	20	Serie 2	108,25
E465G-2-3	50	Serie 2	108,25
E465G-3-1	5	Serie 3	145,75
E465G-3-2	20	Serie 3	145,75
E465G-3-3	50	Serie 3	145,75

Registerfeder

STÅL



Varenr.	BAR	Type	DKK
E465H-0-1	0 - 2	Mini	14,85
E465H-0-2	0 - 4	Mini	14,85
E465H-0-3	0 - 8	Mini	14,85
E465H-0-4	0 - 12	Mini	14,85
E465H-1-1	0 - 2	Serie 1	25,70
E465H-1-2	0 - 4	Serie 1	25,70
E465H-1-3	0 - 8	Serie 1	25,70
E465H-1-4	0 - 12	Serie 1	25,70
E465H-2-1	0 - 2	Serie 2	25,70
E465H-2-2	0 - 4	Serie 2	25,70
E465H-2-3	0 - 8	Serie 2	25,70
E465H-2-4	0 - 12	Serie 2	25,70
E465H-3-1	0 - 2	Serie 3	28,35
E465H-3-2	0 - 4	Serie 3	28,35
E465H-3-3	0 - 8	Serie 3	28,35
E465H-3-4	0 - 12	Serie 3	28,35

Venturi enhed



Varenr.	type	DKK
E465I-0	Mini	6,80
E465I-1	Serie 1	14,85
E465I-2	Serie 2	14,85
E465I-3	Serie 3	14,85

Regulator dele



Varenr.	BAR	Type	DKK
E465J-0-1	0 - 2	Mini	106,75
E465J-0-2	0 - 4	Mini	106,75
E465J-0-3	0 - 8	Mini	106,75
E465J-0-4	0 - 12	Mini	106,75
E465J-1-1	0 - 2	Serie 1	139,00
E465J-1-2	0 - 4	Serie 1	139,00
E465J-1-3	0 - 8	Serie 1	139,00
E465J-1-4	0 - 12	Serie 1	139,00
E465J-2-1	0 - 2	Serie 2	166,25
E465J-2-2	0 - 4	Serie 2	166,25
E465J-2-3	0 - 8	Serie 2	166,25
E465J-2-4	0 - 12	Serie 2	166,25
E465J-3-1	0 - 2	Serie 3	315,50
E465J-3-2	0 - 4	Serie 3	315,50
E465J-3-3	0 - 8	Serie 3	315,50
E465J-3-4	0 - 12	Serie 3	315,50

Lukke- og filter dele



Varenr.	my	Type	DKK
E465K-0-1	5	Mini	74,40
E465K-0-2	20	Mini	74,40
E465K-0-3	50	Mini	74,40
E465K-1-1	5	Serie 1	86,30
E465K-1-2	20	Serie 1	86,30
E465K-1-3	50	Serie 1	86,30
E465K-2-1	5	Serie 2	120,25
E465K-2-2	20	Serie 2	120,25
E465K-2-3	50	Serie 2	120,25
E465K-3-1	5	Serie 3	175,50
E465K-3-2	20	Serie 3	175,50
E465K-3-3	50	Serie 3	175,50

Luftfordeler

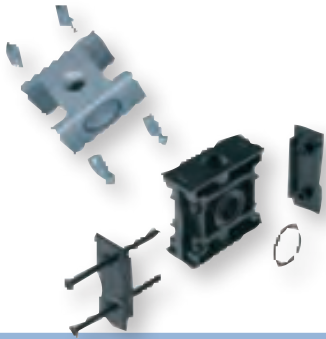

Varenr.	BSPP	Type	DKK
E465L-0	1/8"	Mini	139,00
E465L-1	1/4"	Serie 1	81,05
E465L-2	1/4"	Serie 2	105,25
E465L-3	3/8"	Serie 3	188,00

Olieføder enhed



Varenr.	Type	DKK
E465M-0	Mini	48,60
E465M-1	Serie 1	48,60
E465M-2	Serie 2	48,60
E465M-3	Serie 3	48,60

Reguleringsprop dele



Varenr.	Type	DKK
E465N-0	Mini	35,05
E465N-1	Serie 1	41,75
E465N-2	Serie 2	66,20
E465N-3	Serie 3	121,50

Spole



ø8,15		
Varenr.	Type	DKK
E465T-1	24V DC 3W	91,55
E465T-2	230V AC 5W	91,55

Sinterfilter



Varenr.	my	Type	DKK
E465O-0-1	5	Mini	18,85
E465O-0-2	20	Mini	18,85
E465O-0-3	50	Mini	18,85
E465O-1-1	5	Serie 1	27,05
E465O-1-2	20	Serie 1	27,05
E465O-1-3	50	Serie 1	27,05
E465O-2-1	5	Serie 2	28,35
E465O-2-2	20	Serie 2	28,35
E465O-2-3	50	Serie 2	28,35
E465O-3-1	5	Serie 3	56,55
E465O-3-2	20	Serie 3	56,55
E465O-3-3	50	Serie 3	56,55

Hus til filterelement

PA (POLYAMID)



Varenr.	Type	DKK
E465P-0	Mini	83,40
E465P-1	Serie 1	108,25
E465P-2	Serie 2	174,25
E465P-3	Serie 3	192,00

Hus til auto. vandudskil

PA (POLYAMID)



Varenr.	Type	DKK
E465Q-2	Serie 2	885,50
E465Q-3	Serie 3	903,25

Hus til smøreenhed

PA (POLYAMID)



Varenr.	Type	DKK
E465R-0	Mini	66,20
E465R-1	Serie 1	91,55
E465R-2	Serie 2	157,75
E465R-3	Serie 3	183,25

Hus til auto. olietilførsel

PA (POLYAMID)



Varenr.	Type	DKK
E465s-1	Serie 1	207,75
E465s-2	Serie 2	274,75
E465s-3	Serie 3	299,75

FILTER, REGULATOR & SMØREAPPARATER RUSTFRI



1/4" til 1/2": max 15bar
3/4" til 1": max 20bar



-10°C til +70°C



Rustfri syrefast filterregulator eller smøreapparat. Kan bruges i salte omgivelser, ved halvautomatisk industri og i meget aggressive miljøer. Mulighed for sammenbygning via højtryksnippel. Mulighed for højt indgangstryk på op til 40bar.

FILTERREGULATOR OG SMØREAPPARAT

Bruges til højere tryk ved både tilgang og afgang. Rustfri syrefast AISI 316 krop og beholder, der blandt andet kan bruges i salte omgivelser og ved halvautomatisk industri. Smøreolie kan tilføres uden at stoppe for trykket. Giver derfor en perfekt tågesmøring til dine værktøjer. Oliemængden justeres med en skruetrækker. Dette forhindrer utilsigtet ændring af oliemængden.

SPECIFIKATION:

- Medie:** Luft
- Konstruktion:** Stempel type
- Krop/beholder:** Rustfri AISI 316
- Manometer:** Kappe AISI 304
Gevind AISI 316
- Indgangstryk:** Max 40 bar
- Beholder kap.:** 1/4" - 1/2": 0,1L.
3/4" - 1": 0,2L.
- Filter element:** 5my
- Filter element materiale:** Sintered AISI 316
- Standard aftapning:** Halvautomatisk - kan på forespørgelse leveres hel automatisk.
- Tilbehør:** Manometer bestilles separat
- Vægt:** 1/4" - 1/2" 2000 gram
3/4" - 1" 3000 gram

FILTERREGULATOR

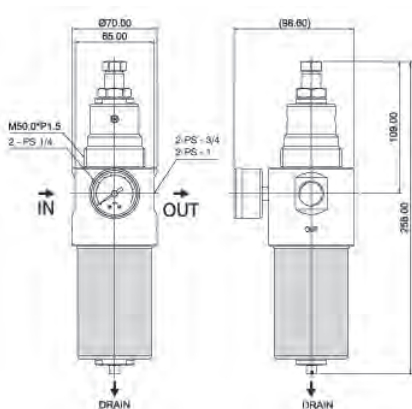

SMØREAPPARAT

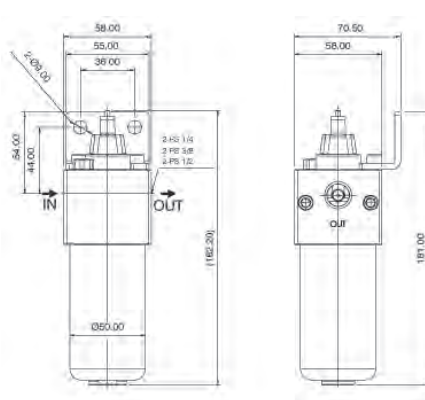

FILTERREGULATOR OG SMØREAPPARAT KAN SAMMENBYGGES

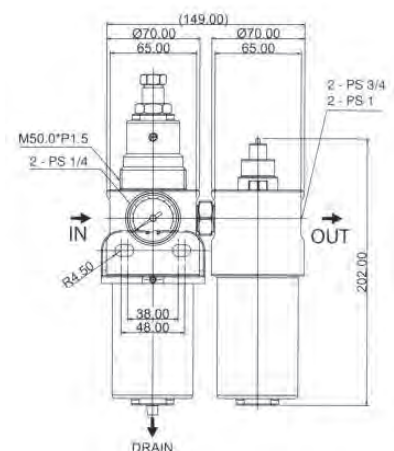

Filter Regulator

AISI 316 - BSPP



Varenr.	BSPP	L/min	DKK
B460-2-2D	1/4"	2200	3298,00
B460-3-2D	3/8"	2500	3298,00
B460-4-2D	1/2"	2800	3298,00
B460-5-2D	3/4"	7250	7478,00
B460-6-2D	1"	7600	7478,00

Smøreapparat

AISI 316 - BSPP



Giver perfekt tågesmøring til værktøjer. Smøreolie kan tilføres uden at stoppe for trykket og justeres med en skruetrækker.

Varenr.	BSPP	L/min	DKK
B460-2-2E	1/4"	2200	1707,25
B460-3-2E	3/8"	2500	1707,25
B460-4-2E	1/2"	2800	1707,25
B460-5-2E	3/4"	7250	5570,50
B460-6-2E	1"	7600	5570,50

Manometer Ø50

AISI 304 / STUDS = AISI 316



BSPP studs bagud

Varenr.	BSPP	BAR	DKK
GC25-4	1/4"	0 - 2,5	530,75 α
GC25-5	1/4"	0 - 4	530,75 α
GC25-6	1/4"	0 - 6	530,75
GC25-7	1/4"	0 - 10	530,75
GC25-8	1/4"	0 - 12	530,75 α
GC25-9	1/4"	0 - 16	530,75 α
GC25-11	1/4"	0 - 25	530,75 α
GC25-12	1/4"	0 - 40	530,75 α

α = skaffevare

Brystnippel højtryk

AISI 316 - BSPT



Varenr.	BSPT	bar	DKK
CP86-2	1/4"	400	110,25
CP86-3	3/8"	400	119,75
CP86-4	1/2"	400	174,00
CP86-5	3/4"	400	239,50
CP86-6	1"	400	329,50
CP86-7	1 1/4"	200	682,75
CP86-8	1 1/2"	200	879,75
CP86-9	2"	100	1153,75

Trykluftolie

RANDO HD32



Rando HD anbefales til brug i alle typer højtydende industrielle og mobile hydrauliske systemer, der arbejder under moderate omgivelsestemperaturer, høje tryk og pumpehastigheder.

Varenr.	L	DKK
S1010-1	1	156,25
S1010-2	2,5	364,25

TRYKLUFFILTRE



Trykluffiltre til brug i systemer, der producerer komprimeret luft. Filtrene leveres med filtrering fra 25 my til 0,5my, hvor mindre tal betyder tættere filter.

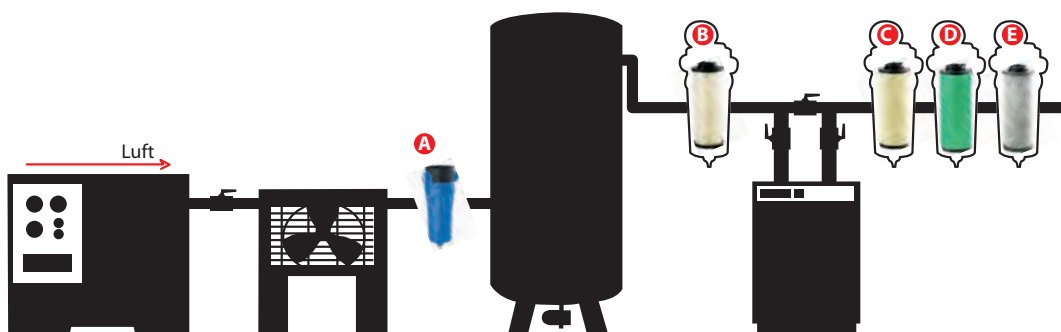



FILTRERINGSGRAD



LUFTKVALITET

PRODUKTEKSEMPLER

INSTALLATIONSEKS.

 <p>Seperatorfilter FA29 ISO 8573-1 klasse 5</p>	<p>Fri for alle faste eller flydende partikler op til 25my.</p>	 <p>FA29</p>	<p>Efter kompressor, før lufttank.</p>
--	---	--	--

EFTER KONDENSUDSKILLER VÆLGES ET FILTER UD FRA NEDENSTÅENDE KRITERIER:

 <p>Filterindsats 5my FA31 ISO 8573-1 klasse 3</p>	<p>Fri for alle faste eller flydende partikler op til 5my.</p>	 <p>FA30</p>	<p>Pneumatisk installation Før vakuumpumpe</p>
 <p>Filterindsats 1my FA33 ISO 8573-1 klasse 2</p>	<p>Fri for alle faste eller flydende partikler op til 1my.</p>	 <p>FA30 + FA32</p>	<p>Malersystemer Pneumatisk værktøj Pneumatisk transport Kompressionsluft motor</p>
 <p>Filterindsats 0,1my FA35 ISO 8573-1 klasse 1</p>	<p>Fri for alle faste eller flydende partikler op til 0,1my.</p>	 <p>FA30 eller FA32 + FA34</p>	<p>Måleinstrument Pneumatiske lejer Robotter Hydraulik</p>
 <p>Aktiv kulfilterindsats FA37 ISO 8573-1 klasse 1</p>	<p>Fri for alle faste eller flydende partikler op til 0,01my.</p>	 <p>FA30 eller FA32 + FA34 + FA36</p>	<p>Kemikalie industri Farmaceutisk industri Sygehuse Fødevareindustri Filmindustri Indåndingsluft</p>

Separatorfilter 25my BSPP



Inkl. filterelement			
Varenr.	BSPP	L/min	DKK
FA29-4	1/2"	1000	1809,75
FA29-5	3/4"	3000	2529,75
FA29-6	1"	5000	3011,75
FA29-8	1 1/2"	9500	4666,00
FA29-9	2"	16500	6028,75
FA29-10	2 1/2"	22000	7874,50

Finfilter 1my BSPP



Inkl. filterelement			
Varenr.	BSPP	L/min	DKK
FA32-4	1/2"	1000	1809,75
FA32-5	3/4"	3000	2529,75
FA32-6	1"	5000	3011,75
FA32-8	1 1/2"	9500	4666,00
FA32-9	2"	16500	6028,75
FA32-10	2 1/2"	22000	7874,50

Aktivkul filter BSPP



Inkl. filterelement			
Varenr.	BSPP	L/min	DKK
FA36-4	1/2"	1000	1809,75
FA36-5	3/4"	3000	2529,75
FA36-6	1"	5000	3011,75
FA36-8	1 1/2"	9500	4666,00
FA36-9	2"	16500	6028,75
FA36-10	2 1/2"	22000	7874,50

Forfilter 5my BSPP



Inkl. filterelement			
Varenr.	BSPP	L/min	DKK
FA30-4	1/2"	1000	1633,75
FA30-5	3/4"	3000	2238,25
FA30-6	1"	5000	2624,50
FA30-8	1 1/2"	9500	4279,75
FA30-9	2"	16500	5344,75
FA30-10	2 1/2"	22000	6511,75

Microfilter 0,1my BSPP



Inkl. filterelement			
Varenr.	BSPP	L/min	DKK
FA34-4	1/2"	1000	1809,75
FA34-5	3/4"	3000	2529,75
FA34-6	1"	5000	3011,75
FA34-8	1 1/2"	9500	4666,00
FA34-9	2"	16500	6028,75
FA34-10	2 1/2"	22000	7874,50

Filterindsats 5my



Varenr.	Dim	Timer	DKK
FA31-4	1/2"	4000	384,00
FA31-5	3/4"	4000	567,25
FA31-6	1"	4000	687,25
FA31-8	1 1/2"	4000	849,00
FA31-9	2"	4000	1374,25
FA31-10	2 1/2"	4000	2143,50

Aktivkul filterindsats



Varenr.	dim	Timer	DKK
FA37-4	1/2"	3500	567,25
FA37-5	3/4"	3500	808,25
FA37-6	1"	3500	1011,00
FA37-8	1 1/2"	3500	1535,75
FA37-9	2"	3500	2422,75
FA37-10	2 1/2"	3500	3535,00

Tids+intervalstyret aftapn.



Varenr.	Str.	DKK
FA42-1	-	1772,75

Filterindsats 1my



Varenr.	dim	Timer	DKK
FA33-4	1/2"	3500	567,25
FA33-5	3/4"	3500	808,25
FA33-6	1"	3500	1011,00
FA33-8	1 1/2"	3500	1535,75
FA33-9	2"	3500	2422,75
FA33-10	2 1/2"	3500	3535,00

Differential indikator



Varenr.	Str.	DKK
FA38-1	-	420,50

Vægbeslag STÅL

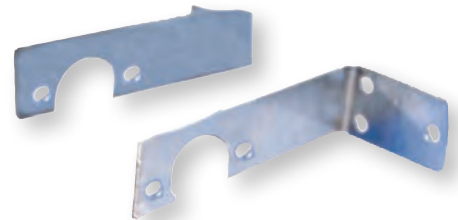

Varenr.	dim	DKK
FA43-4	1/2"	850,25
FA43-5	3/4"	850,25
FA43-6	1"	1104,25
FA43-8	1 1/2"	1104,25

Differential manometer



Varenr.	Str.	DKK
FA39-1	-	1172,25

Montagekit til flere filtre

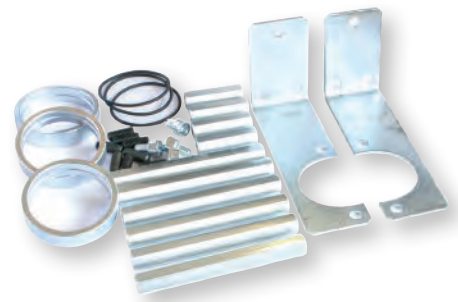

Varenr.	dim	Filter	DKK
FA44-4	1/2"	×2	1359,75
FA44-5	3/4"	×2	1359,75
FA44-6	1"	×2	1958,25
FA44-8	1 1/2"	×2	2208,50
FA45-4	1/2"	×3	1868,50
FA45-5	3/4"	×3	1868,50
FA45-6	1"	×3	2125,00
FA45-8	1 1/2"	×3	2547,25
FA46-4	1/2"	×4	2558,75
FA46-5	3/4"	×4	2558,75
FA46-6	1"	×4	2833,75
FA46-8	1 1/2"	×4	3470,25

Filterindsats 0,1my



Varenr.	dim	Timer	DKK
FA35-4	1/2"	3500	567,25
FA35-5	3/4"	3500	808,25
FA35-6	1"	3500	1011,00
FA35-8	1 1/2"	3500	1535,75
FA35-9	2"	3500	2422,75
FA35-10	2 1/2"	3500	3535,00

Automatisk aftapning



Varenr.	Str.	DKK
FA40-1	-	1052,75

El-styret aftapning



Varenr.	Str.	DKK
FA41-1	-	2160,00

KOMPRESSIONS FITTINGS MESSING INDUSTRI



Messing kompressionsfittings, bredt program til brug i industrien. Særlig stærk til brug under extreme installationer både med hensyn til tryk og temperatur.

Max tryk: Ø4 = 148bar, Ø6 = 148bar, Ø8 = 128 bar, Ø10 = 178bar, Ø12 = 128bar, Ø14 = 113 bar, Ø16 = 74 bar, Ø18 = 59bar, Ø22 = 39bar

Nippel kompres MESSING - BSPT

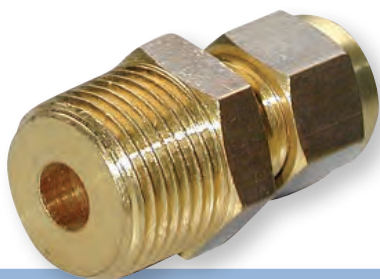

Varenr.	ø × BSPT	DKK
E10480418	4 × 1/8"	11,20
E10480414	4 × 1/4"	10,20
E10480618	6 × 1/8"	11,65
E10480614	6 × 1/4"	13,30
E10480638	6 × 3/8"	16,45
E10480814	8 × 1/4"	14,85
E10480838	8 × 3/8"	17,40
E104801014	10 × 1/4"	19,65
E104801038	10 × 3/8"	19,10
E104801012	10 × 1/2"	20,95
E104801214	12 × 1/4"	19,65
E104801238	12 × 3/8"	19,65
E104801212	12 × 1/2"	23,20
E104801438	14 × 3/8"	22,90
E104801412	14 × 1/2"	23,20
E104801538	15 × 3/8"	48,00
E104801512	15 × 1/2"	23,50
E104801612	16 × 1/2"	26,10
E104801812	18 × 1/2"	31,50
E104801834	18 × 3/4"	37,85
E104802212	22 × 1/2"	55,45
E104802234	22 × 3/4"	56,25
E10480221	22 × 1"	108,00
E104802834	28 × 3/4"	110,00
E10480281	28 × 1"	104,25
E1048028114	28 × 1 1/4"	160,00
E10480351	35 × 1"	158,75
E10480542	54 × 2"	252,25

Nippel kompres MESSING - BSPP



Varenr.	ø × BSPP	DKK
E10485418	4 × 1/8"	16,70
E10485618	6 × 1/8"	17,40
E10485614	6 × 1/4"	19,65
E10485818	8 × 1/8"	19,65
E10485814	8 × 1/4"	20,30
E10485838	8 × 3/8"	31,50
E104851014	10 × 1/4"	31,20
E104851038	10 × 3/8"	37,85
E104851438	14 × 3/8"	40,85
E104851412	14 × 1/2"	51,65
E104852234	22 × 3/4"	102,00
E10485221	22 × 1"	158,75

Muffe kompres MESSING - BSPP



Varenr.	ø × BSPP	DKK
E10500418	4 × 1/8"	13,95
E10500414	4 × 1/4"	15,45
E10500618	6 × 1/8"	14,85
E10500614	6 × 1/4"	15,75
E10500818	8 × 1/8"	16,20
E10500814	8 × 1/4"	17,10
E10500838	8 × 3/8"	19,35
E105001014	10 × 1/4"	19,65
E105001038	10 × 3/8"	21,30
E105001012	10 × 1/2"	23,80
E105001214	12 × 1/4"	20,95
E105001238	12 × 3/8"	22,60
E105001212	12 × 1/2"	25,45
E105001438	14 × 3/8"	23,50
E105001512	15 × 1/2"	26,10
E105001612	16 × 1/2"	29,50
E105001634	16 × 3/4"	37,85
E105001812	18 × 1/2"	30,90
E105001834	18 × 3/4"	40,00
E105002234	22 × 3/4"	57,90
E10500281	28 × 1"	46,95
E1050042112	42 × 1 1/2"	142,75
E10500542	54 × 2"	257,25

Union kompres

MESSING



Varenr.	∅	DKK
E104604	4	18,40
E104606	6	20,70
E104608	8	23,80
E1046010	10	27,05
E1046012	12	31,50
E1046014	14	35,85
E1046015	15	36,70
E1046016	16	42,20
E1046018	18	49,95
E1046022	22	84,65
E1046028	28	92,25

Skotgennemføring kompres

MESSING



Varenr.	∅	Ext. dim	DKK
E104654	4	8	18,40
E104656	6	10	20,70
E104658	8	12	40,85
E1046510	10	16	27,05
E1046512	12	18	31,50
E1046514	14	20	35,85

Slangenippel kompres

MESSING



Varenr.	A × B	DKK
E105400810	10 × 8	18,75
E105401010	10 × 10	19,65
E105401213	13 × 12	24,80

Nippel m. rørstyrke

MESSING - BSPP



Varenr.	∅ × BSPP	DKK
E10530618	6 × 1/8"	14,25
E105301014	10 × 1/4"	18,40
E105301038	10 × 3/8"	31,50

Prop kompres

MESSING



Varenr.	∅	DKK
E107806	6	5,85
E107808	8	7,15
E1078010	10	8,30
E1078012	12	10,20
E1078014	14	12,55
E1078015	15	14,85
E1078016	16	16,20
E1078018	18	19,35
E1078022	22	22,60

Vinkel 90° kompres

MESSING

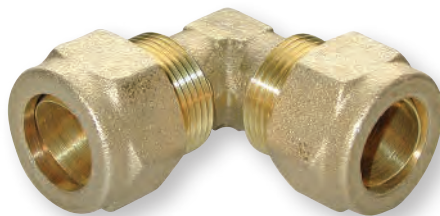

Varenr.	∅	DKK
E102604	4	19,65
E102606	6	22,60
E102608	8	26,10
E1026010	10	30,90
E1026012	12	37,85
E1026014	14	42,20
E1026015	15	45,25
E1026016	16	51,65
E1026018	18	60,05
E1026022	22	95,30
E1026042	42	292,25

Vinkel 90° kompres/nippel

MESSING - BSPT



Varenr.	∅ × BSPT	DKK
E10280418	4 × 1/8"	13,95
E10280618	6 × 1/8"	16,20
E10280614	6 × 1/4"	15,75
E10280818	8 × 1/8"	18,75
E10280814	8 × 1/4"	19,10
E10280838	8 × 3/8"	21,60
E102801014	10 × 1/4"	22,60
E102801038	10 × 3/8"	22,60
E102801012	10 × 1/2"	26,75
E102801214	12 × 1/4"	24,80
E102801238	12 × 3/8"	26,10
E102801212	12 × 1/2"	28,40
E102801412	14 × 1/2"	33,65
E102801512	15 × 1/2"	35,05
E102801612	16 × 1/2"	38,60
E102801812	18 × 1/2"	46,95
E102801834	18 × 3/4"	48,00
E102802234	22 × 3/4"	71,55
E102802834	28 × 3/4"	99,95

Vinkel 90° kompres/muffe

MESSING - BSPP



Varenr.	∅ × BSPP	DKK
E10290418	4 × 1/8"	16,20
E10290618	6 × 1/8"	17,10
E10290614	6 × 1/4"	17,75
E10290818	8 × 1/8"	19,35
E10290814	8 × 1/4"	26,75
E10290838	8 × 3/8"	26,10
E102901014	10 × 1/4"	22,90
E102901038	10 × 3/8"	27,35
E102901012	10 × 1/2"	29,25
E102901214	12 × 1/4"	26,40
E102901238	12 × 3/8"	28,70
E102901212	12 × 1/2"	31,20
E102901512	15 × 1/2"	37,25
E102901612	16 × 1/2"	39,75
E102901812	18 × 1/2"	46,95
E102901834	18 × 3/4"	52,15

Banjo kompres/nippel

MESSING - BSPP



Varenr.	ø × BSPP	DKK
E10550418	4 × 1/8"	47,45
E10550618	6 × 1/8"	38,90
E10550818	8 × 1/8"	57,90
E10550814	8 × 1/4"	57,90
E105501014	10 × 1/4"	89,25
E105501038	10 × 3/8"	94,50

T-stk kompres

MESSING



Varenr.	ø	DKK
E102004	4	26,75
E102006	6	30,35
E102008	8	35,05
E1020010	10	44,15
E1020012	12	49,95
E1020014	14	64,45
E1020016	16	71,55
E1020018	18	89,00
E1020022	22	130,25
E1020042	42	347,25

T-stk kompres/nippel gren

MESSING - BSPT



Varenr.	ø × BSPT × ø	DKK
E10220418	4 × 1/8" × 4	21,30
E10220618	6 × 1/8" × 6	24,50
E10220614	6 × 1/4" × 6	24,80
E10220818	8 × 1/8" × 8	28,15
E10220814	8 × 1/4" × 8	28,40
E10220838	8 × 3/8" × 8	33,40
E102201014	10 × 1/4" × 10	35,60
E102201038	10 × 3/8" × 10	40,55
E102201012	10 × 1/2" × 10	38,90
E102201214	12 × 1/4" × 12	39,15
E102201238	12 × 3/8" × 12	40,00
E102201212	12 × 1/2" × 12	41,95
E102201412	14 × 1/2" × 14	54,05
E102201812	18 × 1/2" × 18	73,15
E102201834	18 × 3/4" × 18	75,10
E102202234	22 × 3/4" × 22	110,25

T-stk kompres/muffe gren

MESSING - BSPP



Varenr.	ø × BSPP × ø	DKK
E10240618	6 × 1/8" × 6	24,50
E10240614	6 × 1/4" × 6	30,90
E10240818	8 × 1/8" × 8	27,65
E10240814	8 × 1/4" × 8	33,40
E10240838	8 × 3/8" × 8	36,45
E102401014	10 × 1/4" × 10	35,60
E102401038	10 × 3/8" × 10	38,35
E102401012	10 × 1/2" × 10	43,05
E102401214	12 × 1/4" × 12	41,45
E102401238	12 × 3/8" × 12	41,45
E102401212	12 × 1/2" × 12	39,75
E102401512	15 × 1/2" × 15	54,60
E102401612	16 × 1/2" × 16	60,65
E102401812	18 × 1/2" × 18	73,15

T-stk kompres/nippel ende

MESSING - BSPT



Varenr.	BSPT × ø × ø	DKK
E10230618	1/8" × 6 × 6	24,80
E10230614	1/4" × 6 × 6	24,80
E10230818	1/8" × 8 × 8	28,15
E10230814	1/4" × 8 × 8	28,40
E10230838	3/8" × 8 × 8	32,85
E102301014	1/4" × 10 × 10	35,60
E102301038	3/8" × 10 × 10	35,85
E102301238	3/8" × 12 × 12	40,00
E102301212	1/2" × 12 × 12	45,50

Kryds kompres

MESSING



Varenr.	ø	DKK
E105106	6	62,00
E105108	8	74,80
E1051010	10	94,20
E1051014	14	118,75

Rør i rulle

KOBBER



Varenr.	Ø	- -	L	DKK/m
CU1-1	4	1	65m	31,60
CU1-4	6	1	50m	45,70
CU1-6	8	1	50m	52,05
CU1-8	10	1	50m	70,45
CU1-9	12	1	50m	78,65
	ø			
CU2-0	1/8"		50m	97,80
CU2-1	3/16"		50m	45,35
CU2-2	1/4"		50m	52,30
CU2-4	3/8"		50m	59,00
CU2-6	1/2"		50m	79,75

Sælges kun i fuld længde

Skotgennemføring kompres

MESSING



Varenr.	∅	Ext. dim	DKK
E114515	15	21	46,05
E114522	22	29	61,70
E114528	28	35	91,75
E114535	35	42	166,25
E114542	42	49	250,50
E114554	54	64	332,25

T-stk kompres m. aftap

MESSING



Varenr.	∅	DKK
E114215	15	109,50
E114222	22	120,75
E114228	28	144,25

Vinkel 90° kompres/muffe

MESSING - BSPP



Med vægbeslag		
Varenr.	∅ × BSPP	DKK
E11061012	10 × 1/2"	35,60
E11061212	12 × 1/2"	35,60
E11061412	14 × 1/2"	35,60
E11061512	15 × 1/2"	37,85
E11061534	15 × 3/4"	81,40
E11061612	16 × 1/2"	35,60
E11061812	18 × 1/2"	66,10
E11061834	18 × 3/4"	78,90
E11062212	22 × 1/2"	71,00
E11062234	22 × 3/4"	87,95

Slutmuffe kompres

MESSING



Varenr.	∅	DKK
E113508	8	15,75
E113510	10	14,85
E113512	12	12,30
E113515	15	16,70
E113518	18	32,30
E113522	22	29,25
E113528	28	42,50
E113535	35	141,75
E113542	42	194,25
E113554	54	236,75

Omløber kompres

MESSING



Varenr.	∅	Int. dim	DKK
E106804	4	M8*1	3,52
E106806	6	M10*1	3,86
E106808	8	M12*1	4,74
E1068010	10	M16*1,5	6,45
E1068012	12	M18*1,5	6,85
E1068014	14	M20*1,5	7,15
E1068015	15	M20*1,5	7,15
E1068016	16	M22*1,5	8,15
E1068018	18	M24*1,5	10,45
E1068022	22	M30*1,5	19,35

Konusring kompres

MESSING



Varenr.	∅	DKK
E107404	4	1,32
E107406	6	1,60
E107408	8	1,82
E1074010	10	2,32
E1074012	12	2,87
E1074014	14	3,75
E1074015	15	3,64
E1074016	16	4,52
E1074018	18	4,90
E1074020	20	8,50
E1074022	22	6,20
E1074028	28	9,60

Konusring kompres

PTFE (TEFLON)



Varenr.	∅	DKK
E107604	4	1,32
E107606	6	1,60
E107608	8	1,82
E1076010	10	2,32
E1076012	12	3,09
E1076015	15	3,64
E1076018	18	4,90
E1076022	22	6,20

Støttebøsning

MESSING



Varenr.	∅1	∅2	DKK
E10770427	2,7	4	3,25
E1077064	4	6	3,42
E1077086	6	8	3,52
E10770108	8	10	3,86
E10770129	9	12	4,19
E107701210	10	12	4,31
E107701412	12	14	8,15
E1077015125	12,5	15	7,15
E107701613	13	16	7,25
E107701614	14	16	8,40
E107701815	15	18	10,75
E107701816	16	18	10,75
E107702218	18	22	10,75
E107702820	20	28	15,75
E107702822	22	28	14,70

∅1 = hylse udvendigt, ∅2 = krave udvendigt

ROYKON A/S

- EN ARBEJDSPLADS FOR MEDARBEJDERNE

Vi gør alt, for at have en god arbejdsplads med plads til alle.

Vi holder af vores medarbejdere og forsøger konstant at udvikle virksomheden.

Vi holder undervisning i vores produkter, således medarbejderne er fortrolige med dem.

Vi har medarbejdere på flextid, vi har medarbejdere på parttids barselsordning, vi har medarbejdere på halvdag, blot for at nævne nogle af dem.

Årlige traditioner som sommerfest og julefrokost er en del af virksomheden og en god måde at komme til at kende hinanden bedre på.

Vi har rigtig mange kunder, der har handlet hos os i mange år, som vi også følger i tykt og tyndt. Vi mener, motiverede medarbejdere gør en forskel i den daglige kontakt.

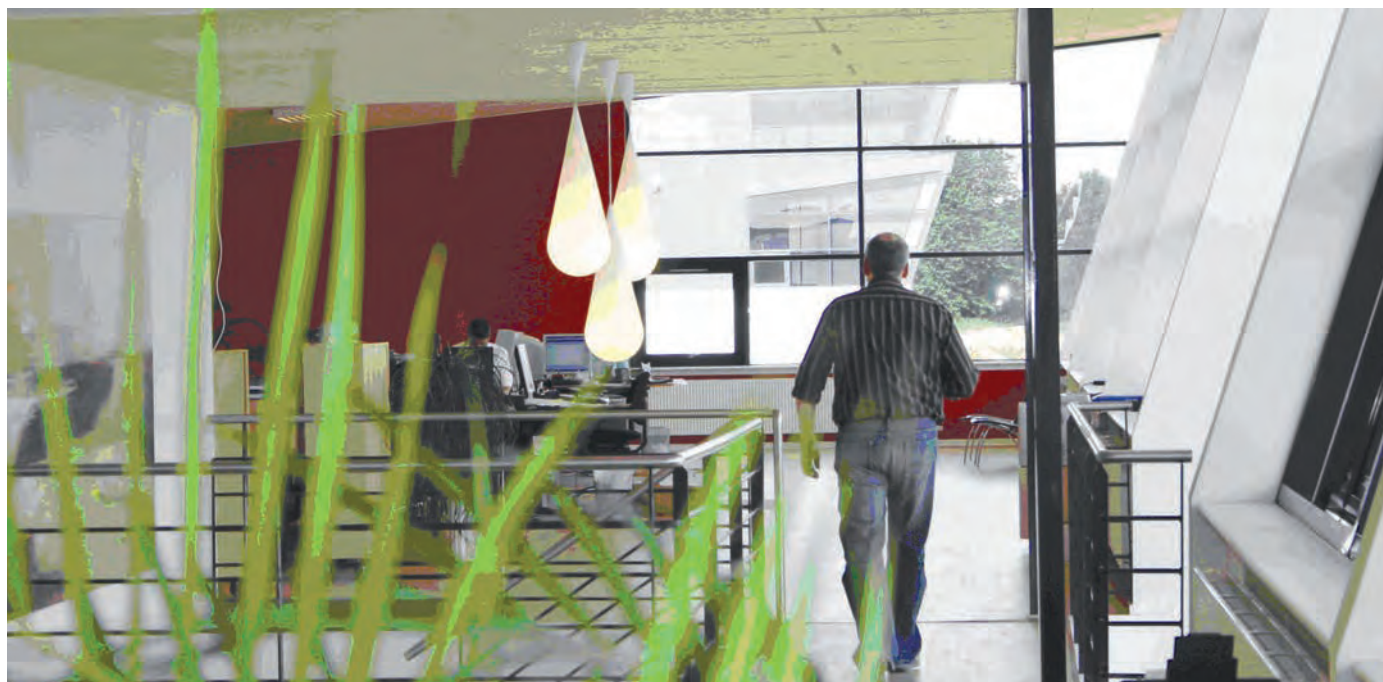

SVIVEL FITTINGS



Svivel fittings i forskellige udførelse, mange af dem beregnet til højtryk. Fås i rustfri stål og messing.

Svivel nip/muf flow: 30L/min MESSING - BSPP×BSPT

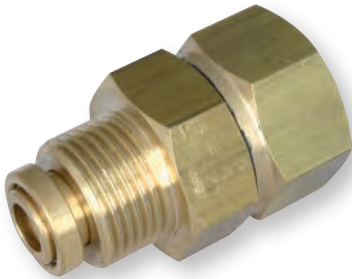

Arbejdstryk: 220bar - max: 250bar
Arbejdstemperatur: +90°C

Varenr.	BSPT × BSPP	DKK
E30s-3-2	3/8" × 1/4"	393,00
E30s-3	3/8"	164,25

Svivel nip/muf flow: 40L/min MESSING - BSPP×BSPT



Arbejdstryk: 250bar - max: 280bar
Arbejdstemperatur: +160°C

Varenr.	BSPT × BSPP	DKK
E32s-2	1/4"	726,25
E32s-3	3/8"	726,25
E32s-4	1/2"	UDGÅET

Svivel nip/muf 160L/min MESSING - 1/2" BSPP×1/2" BSPT

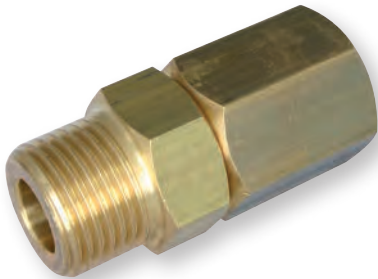

Arbejdstryk: 200bar - max: 220bar
Arbejdstemperatur: +90°C

Varenr.	BSPT × BSPP	DKK
E31s-4	1/2"	358,00

Svivel nip/muf 100L/min MESSING - 1/2" BSPP



Arbejdstryk: 24bar
Arbejdstemperatur: +90°C

Varenr.	BSPP	DKK
E33s-4	1/2"	UDGÅET

Svivel nip/muf 160L/min

AISI 316 - 1/2" BSPTx1/2" BSPP



Arbejdstryk: 200bar - max: 220bar
Arbejdtemperatur: +90°C
Positionsniappel

Varenr.	BSPTxBSPP	DKK
B40s-4	1/2"	1109,50

Svivel 90° muf/nip 80L/min

AISI 316 - 1/2" BSPTx1/2" BSPP



Arbejdstryk: 350bar - max: 390bar
Arbejdtemperatur: +90°C
Max 30 RPM

Varenr.	BSPTxBSPP	DKK
B43s-4	1/2"	4155,00

Forlænger svivel

MESSING - BSPPxBSPT



Varenr.	BSPP x BSPT	DKK
E30-61	1/8"	29,50
E30-62	1/4"	35,60
E30-63	3/8"	43,85

Forlænger svivel

MESSING - BSPP

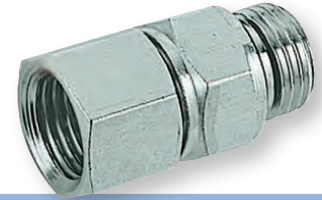

Varenr.	BSPP	DKK
E30-71	1/8"	29,50
E30-72	1/4"	35,60
E30-73	3/8"	43,85

Svivel nip/muf 40L/min

AISI 316 - BSPTxBSPP



Arbejdstryk: 350bar - max: 390bar
Arbejdtemperatur: +160°C
Max 30 RPM

Varenr.	BSPTxBSPP	DKK
B41s-2	1/4"	1982,50
B41s-3	3/8"	880,75

Svivel nippel/muffe 40L/min

AISI 316 - BSPP



Arbejdstryk: 250bar - max: 280bar
Arbejdtemperatur: +120°C
Max 30 RPM

med kugleleje		
Varenr.	BSPP	DKK
B44s-2	1/4"	3352,50
B44s-3	3/8"	1511,25

Svivel

MESSING - BSPP



Varenr.	BSPP	L	DKK
E30-81	1/8"	25	16,25
E30-82	1/4"	29	21,75
E30-83	3/8"	33	42,00
E30-84	1/2"	37	68,00
E30-85	3/4"	48,5	123,00
E30-86	1"	52	167,00

Svivel 90° muf/nip 40L/min

MESSING - BSPPxBSPT



Arbejdstryk: 250bar - max: 280bar
Arbejdtemperatur: +90°C

Skruer = AISI 316		
Varenr.	BSPPxBSPT	DKK
B42s-2	1/4"	2217,50
B42s-3	3/8"	1247,00

Svivel nippel/muffe 60L/min

AISI 316 - 3/8" BSPTx3/8" BSPP



Arbejdstryk: 600bar - max: 660bar
Arbejdtemperatur: +100°C
Max 30 RPM

Varenr.	BSPTxBSPP	DKK
B45s-3	3/8"	6675,00

PUSH-IN FITTINGS RUSTFRI AISI 316



B serie: -0,99 til +15 bar
CP serie: -0,99 til +140 bar



B serie: -15°C til +225°C
CP serie: -110°C til +300°C



Rustfri syrefast push-in fittings i flot, ergonomisk design. Kan bruges til mange slags rør: PA, PE, PU samt PTFE. Alle cylindriske gevind kommer med VITON O-ringe, der sikrer nem og hurtig montering og gør dem særdeles velegnet til farmaceutisk-, kemi-, fødevarer- og medicinalindustri. Fødevarer godkendt.



Vores fødevarerprodukter opfylder kravene til direkte kontakt med fødevarer.

Fittings der hører til eliten!

Push-in har en ring med bagudrettede tænder, der griber ind i slangen og hindrer, at man kan trække slangen ud. Udløseringen presser tænderne væk fra slangen, der så kan tages ud af fittingen.

Selve tætningen er en O-ring, placeret lige under de tænder, der fastholder slangen i fittingen. O-ringstype se teknisk beskrivelse.

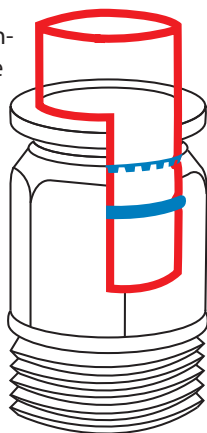

Nippel push-in

AISI 316 - BSPT



Varenr.	ø × BSPT	DKK
B80-1	4 × 1/8"	173,25
B80-1-1	4 × 1/4"	193,00
B80-2	6 × 1/8"	206,50
B80-3	6 × 1/4"	216,75
B80-4	8 × 1/8"	227,75
B80-5	8 × 1/4"	233,25
B80-6	10 × 1/4"	302,25
B80-7	10 × 3/8"	239,25
B80-8	12 × 3/8"	477,50
B80-9	12 × 1/2"	531,00

Nippel push-in

AISI 316 / VITON - BSPP



Varenr.	ø × BSPP	DKK
B81-1	4 × M5	239,00
B81-2	4 × 1/8"	235,50
B81-2-1	4 × 1/4"	237,75
B81-3	6 × 1/8"	235,50
B81-4	6 × 1/4"	263,75
B81-5	8 × 1/8"	261,50
B81-6	8 × 1/4"	296,75
B81-7	10 × 1/4"	324,00
B81-8	10 × 3/8"	392,00
B81-9	12 × 3/8"	493,25
B81-10	12 × 1/2"	546,75

Vinkel 90° push-in

AISI 316



Varenr.	ø	DKK
B82-1	4	335,50
B82-2	6	357,25
B82-3	8	413,25
B82-4	10	568,25
B82-5	12	790,00

Vinkel 90° push-in/nippel svivel

AISI 316 - BSPT



Varenr.	ø × BSPT	DKK
B84-0	4 × 1/8"	440,75
B84-2	4 × 1/4"	481,75
B84-3	6 × 1/8"	444,00
B84-4	6 × 1/4"	510,50
B84-5	8 × 1/8"	520,75
B84-6	8 × 1/4"	529,75
B84-7	10 × 1/4"	699,25
B84-8	10 × 3/8"	715,00
B84-8-1	10 × 1/2"	740,25
B84-9	12 × 3/8"	914,25
B84-10	12 × 1/2"	940,50

Vinkel 90° push-in/nippel svivel

AISI 316 / VITON - BSPP



Varenr.	∅ × BSPP	DKK
B86-1	4 × M5	433,25
B86-2	4 × 1/8"	447,75
B86-2-1	4 × 1/4"	482,75
B86-3	6 × 1/8"	482,75
B86-4	6 × 1/4"	513,50
B86-5	8 × 1/8"	528,50
B86-6	8 × 1/4"	531,00
B86-8	10 × 1/4"	703,00
B86-9	10 × 3/8"	774,25
B86-10	10 × 1/2"	967,75
B86-11	12 × 3/8"	932,75
B86-12	12 × 1/2"	1186,75

T-stk push-in/nippel svivel

AISI 316 - BSPT



Varenr.	∅ × BSPT × ∅	DKK
B89K-1	4 × 1/8" × 4	463,00
B89K-2	4 × 1/4" × 4	586,25
B89K-3	6 × 1/8" × 6	588,75
B89K-4	6 × 1/4" × 6	626,00
B89K-5	8 × 1/8" × 8	651,75
B89K-6	8 × 1/4" × 8	660,75
B89K-7	10 × 1/4" × 10	902,25
B89K-8	10 × 3/8" × 10	916,25
B89K-9	10 × 1/2" × 10	942,50
B89K-10	12 × 3/8" × 12	1180,50
B89K-11	12 × 1/2" × 12	1205,25

Union push-in

AISI 316



Varenr.	∅	DKK
B97-1	4	258,75
B97-2	6	262,75
B97-3	8	300,75
B97-4	10	407,25
B97-5	12	603,00

T-stk push-in

AISI 316



Varenr.	∅	DKK
B94-1	4	471,25
B94-2	6	494,75
B94-3	8	572,00
B94-4	10	769,75
B94-5	12	956,25

T-stk push-in/nippel svivel

AISI 316 / VITON - BSPP



Varenr.	∅ × BSPP × ∅	DKK
B89C-1	4 × M5 × 4	528,50
B89C-2	4 × 1/8" × 4	513,50
B89C-3	4 × 1/4" × 4	588,75
B89C-4	6 × 1/8" × 6	621,75
B89C-5	6 × 1/4" × 6	626,00
B89C-6	8 × 1/8" × 8	658,50
B89C-7	8 × 1/4" × 8	662,25
B89C-8	10 × 1/4" × 10	906,75
B89C-9	10 × 3/8" × 10	977,50
B89C-10	10 × 1/2" × 10	1171,25
B89C-11	12 × 3/8" × 12	1197,00
B89C-12	12 × 1/2" × 12	1453,50

Skotgennemføring push-in

AISI 316



Varenr.	∅	Ext. dim	DKK
B98-1	4	M12*1	428,00
B98-2	6	M14*1	462,00
B98-3	8	M16*1	552,00
B98-4	10	M20*1	703,00
B98-5	12	M22*1	865,75

Brystnippel

AISI 316 - BSPT



Max 140 bar

Varenr.	BSPT	DKK
CP200-1	1/8"	109,50
CP200-2	1/4"	133,00
CP200-3	3/8"	145,50
CP200-4	1/2"	174,00
CP200-5	3/4"	199,50

Nippelmuffe

AISI 316 - BSPT×BSPP



Max 140 bar

Varenr.	BSPT × BSPP	DKK
CP203-2-1	1/4" × 1/8"	127,00
CP203-3-1	3/8" × 1/8"	138,75
CP203-3-2	3/8" × 1/4"	142,00
CP203-4-2	1/2" × 1/4"	169,25
CP203-4-3	1/2" × 3/8"	178,75
CP203-5-4	3/4" × 1/2"	215,25

Rørprop Unbrako

AISI 316 / VITON - BSPP



-15° til +225°C, 15bar

Varenr.	BSPP	DKK
CP206-1	1/8"	157,25
CP206-2	1/4"	175,50
CP206-3	3/8"	194,75
CP206-4	1/2"	195,75

Brystnippel reduktion

AISI 316 - BSPT



Max 140 bar

Varenr.	BSPT	DKK
CP201-1-2	1/4" × 1/8"	150,25
CP201-1-3	3/8" × 1/8"	163,75
CP201-2-3	3/8" × 1/4"	163,75
CP201-2-4	1/2" × 1/4"	187,50
CP201-3-4	1/2" × 3/8"	188,50
CP201-4-5	3/4" × 1/2"	253,25

Muffe

AISI 316 - BSPP



Max 140 bar

Varenr.	BSPP	DKK
CP204-1	1/8"	61,70
CP204-2	1/4"	87,35
CP204-3	3/8"	124,00
CP204-4	1/2"	200,50
CP204-5	3/4"	300,00

Rørprop sekskant

AISI 316 - BSPT



Max 140 bar

Varenr.	BSPT	DKK
CP207-1	1/8"	118,00
CP207-2	1/4"	129,25
CP207-3	3/8"	142,00
CP207-4	1/2"	176,50
CP207-5	3/4"	220,00

Spidsmuffe

AISI 316 - BSPP×BSPT



Max 140 bar

Varenr.	BSPP × BSPT	DKK
CP202-1-2	1/4" × 1/8"	140,00
CP202-2-3	3/8" × 1/4"	171,50
CP202-2-4	1/2" × 1/4"	211,00
CP202-3-4	1/2" × 3/8"	215,25
CP202-4-5	3/4" × 1/2"	275,00

Formmuffe

AISI 316 - BSPP



Max 140 bar

Varenr.	BSPP	DKK
CP205-1-2	1/4" × 1/8"	82,75
CP205-2-3	3/8" × 1/4"	122,25
CP205-3-4	1/2" × 3/8"	152,50
CP205-4-5	3/4" × 1/2"	255,25

Rørprop Unbrako

AISI 316 - BSPT



Max 140 bar

Varenr.	BSPT	DKK
CP208-1	1/8"	100,25
CP208-2	1/4"	108,50
CP208-3	3/8"	121,50
CP208-4	1/2"	153,50

Slangenippel

AISI 316 - BSPT



Max 140 bar

Varenr.	Ø × BSPT	DKK
CP209-1	6 × 1/8"	72,90
CP209-2	7 × 1/8"	72,90
CP209-3	7 × 1/4"	88,75
CP209-4	8 × 1/4"	88,75
CP209-5	9 × 1/4"	88,75
CP209-6	9 × 3/8"	115,00
CP209-7	10 × 1/4"	88,75
CP209-8	10 × 3/8"	115,00
CP209-9	10 × 1/2"	172,75
CP209-10	12 × 1/4"	88,75
CP209-11	12 × 3/8"	115,00
CP209-12	12 × 1/2"	172,75
CP209-13	14 × 3/8"	113,50
CP209-14	14 × 1/2"	172,75
CP209-15	16 × 1/2"	172,75
CP209-16	18 × 1/2"	172,75
CP209-17	18 × 3/4"	246,50
CP209-18	20 × 1/2"	172,75
CP209-19	20 × 3/4"	246,50

Slangenippel

AISI 316 / VITON - BSPP



Varenr.	Ø × BSPP	DKK
B105-10	10 × 1/4"	125,75
B105-11	10 × 3/8"	171,00
B105-12	12 × 3/8"	182,00
B105-13	12 × 1/2"	270,00

Vinkel 90° muffe

AISI 316 - BSPP



Max 140 bar

Varenr.	BSPP	DKK
CP213-1	1/8"	243,00
CP213-2	1/4"	332,00
CP213-3	3/8"	415,75
CP213-4	1/2"	510,00

Vinkel 90° muffe/nippel

AISI 316 - BSPP × BSPT



Max 140 bar

Varenr.	BSPP × BSPT	DKK
CP214-1	1/8"	243,00
CP214-2	1/4"	332,00
CP214-3	3/8"	415,75
CP214-4	1/2"	510,00

T-stk muffe

AISI 316 - BSPP



Max 140 bar

Varenr.	BSPP	DKK
CP210-1	1/8"	301,25
CP210-2	1/4"	422,75
CP210-3	3/8"	546,50
CP210-4	1/2"	674,00

T-stk muffe/nippel/muffe

AISI 316 - BSPP × BSPT



Max 140 bar

Varenr.	BSPP × BSPT × BSPP	DKK
CP211-1	1/8"	301,25
CP211-2	1/4"	422,75
CP211-3	3/8"	546,50
CP211-4	1/2"	674,00

T-stk muffe/muffe/nippel

AISI 316 - BSPT × BSPP



Max 140 bar

Varenr.	BSPT × BSPP × BSPP	DKK
CP212-1	1/8"	301,25
CP212-2	1/4"	422,75
CP212-3	3/8"	546,50
CP212-4	1/2"	674,00

PUSH-IN FITTINGS MESSING HØJTRYK



0 bar til +150 bar ved væsker
0 bar til +30 bar ved luft



-30°C til +150°C

Denne serie messingfittings kan tåle op til 150 bar tryk, når de bruges til olie, vand eller fedt. Brugt som luftfittings er max. tryk 30 bar.

Nippel push-in/nippel højtryk

MESSING - BSPT



Varenr.	ø × BSPT	DKK
EH80-1	4 × 1/8"	31,20
EH80-2	6 × 1/8"	31,20

Vinkel 90° push-in/nip højtryk

MESSING - BSPT



Varenr.	ø × dim	DKK
EH83-1	4 × M6*1	59,25
EH83-2	4 × M8*1	61,45
EH83-3	4 × M10*1	46,65
EH83-4	4 × 1/8"	46,65
EH83-5	6 × M6*1	46,65
EH83-6	6 × M8*1	46,65
EH83-7	6 × M10*1	50,50
EH83-8	6 × 1/8"	50,50

Nippel push-in/nippel højtryk

MESSING - BSPP



Varenr.	ø × dim	DKK
EH81-1	4 × M6*1	31,20
EH81-2	4 × M8*1	31,20
EH81-3	4 × M10*1	36,70
EH81-4	6 × M6*1	36,70
EH81-5	6 × M8*1	36,70
EH81-6	6 × M10*1	34,75

Vinkel 90° push-in/nip svivel

MESSING - BSPT

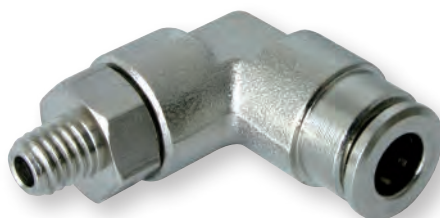

Højtryk		
Varenr.	ø × BSPT	DKK
EH84-1	4 × 1/8"	50,50
EH84-2	6 × 1/8"	50,50

Vinkel 90° push-in/nip svivel

MESSING - MM

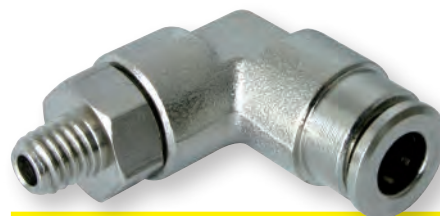

Højtryk		
Varenr.	ø × dim	DKK
EH85-1	4 × M6*1	60,90
EH85-2	4 × M8*1	60,90
EH85-3	4 × M10*1	60,90
EH85-4	6 × M6*1	60,90
EH85-5	6 × M8*1	62,30
EH85-6	6 × M10*1	62,30

Union push-in højtryk

MESSING



Varenr.	ø	DKK
EH97-1	4	65,55
EH97-2	6	65,55

Højtryksslange 100m neutral

PA (POLYAMID)



Varenr.	Ø/ø	U	DKK
J10400402	4/2	25	578,00
J10400603	6/3	45	1084,75

U = bøjeradius i mm

STØDDÆMPERE



Denne serie af støddæmpere i en normal version, en tung version med højere drejningsmoment og en dobbelt udgave, giver mange forskellige længder til stødabsorbering.

Hydraulisk støddæmper

STÅL



Stempel Ø6

Varenr.	Stroke	Max Nm/cycl	Max m/s	DKK
VS4-20H	20	35	3.2	694,75
VS4-20M	20	35	2	681,75
VS4-20L	20	35	1.2	694,75
VS4-30H	30	46	3.2	747,75
VS4-30M	30	46	2	736,75
VS4-30L	30	46	1.2	747,75
VS4-50H	50	62	4.2	1068,25
VS4-50M	50	62	2.6	1036,25
VS4-50L	50	62	1.5	1068,25

Hydraulisk støddæmper

STÅL



Stempel Ø5

Varenr.	Stroke	Max Nm/cycl	Max m/s	DKK
VS6-30H	30	46	3.2	1406,00
VS6-30M	30	46	2	1384,50
VS6-30L	30	46	1.2	1406,00

Stopkrave

STÅL



Varenr.	Dim	L	DKK
VS10-0	M8×1,0	15	26,75
VS10-1	M10×1,0	17	35,50
VS10-2	M12×1,0	20	35,75
VS10-3	M14×1,0	27	71,00
VS10-4	M20×1,5	36	89,00
VS10-5	M25×1,5	46	109,00
VS10-6	M25×1,5	66	115,50
VS10-7	M36×1,5	80	267,75

Hydraulisk støddæmper

STÅL



Stempel Ø8

Varenr.	Stroke	Max Nm/cycl	Max m/s	DKK
VS5-25H	25	78	3.2	999,25
VS5-25M	25	78	2	976,00
VS5-25L	25	78	1.2	999,25

PROFIL SKALA 1:1

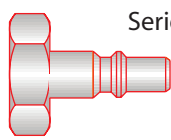

Serie 200 mini

$\text{\textcircled{DN}}$ 2,5 mm

Kompatibilitet:
Norma UNI ISO 6150 A-6

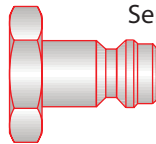

Serie 210 mignon

$\text{\textcircled{DN}}$ 5 mm

Kompatibilitet: Mignon, Rectus 21, Rectus 90, Camozzi 5150, Asturo 11400, Legris 21.

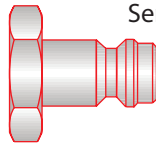

Serie 210 mignon, dobbelt

$\text{\textcircled{DN}}$ 5 mm

Kompatibilitet: Mignon, Rectus 21, Rectus 90, Camozzi 5150, Asturo 11400, Legris 21.

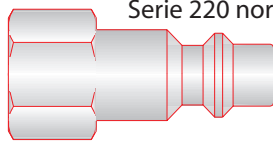

Serie 220 norma

$\text{\textcircled{DN}}$ 5,5 mm

Kompatibilitet: Norma UNI ISO 6150 B-12, Rectus 23, Rectus 24, US-MIL SPEC C-4109, Hansen 3000, Gromelle 600, Parker 30 1/4, CEJN 310, JWL 521/531, Nordgren Dynaquip DC3.

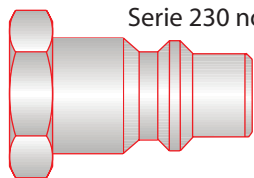

Serie 230 norma

$\text{\textcircled{DN}}$ 9 mm

Kompatibilitet:
Norma UNI ISO 6150 B-15, Rectus 30, US-MIL SPEC C-4109, Hansen 4000, Gromelle 90, ARO, Parker 30 3/8.

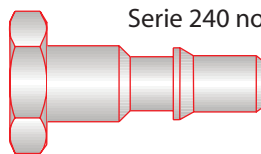

Serie 240 norma

$\text{\textcircled{DN}}$ 5,5 mm

Kompatibilitet: Norma UNI ISO 6150 C-10, Rectus 18, Staubli RCS-RBE 6, Oetiker ISO standard DP 6150, CEJN 291, Gromelle, Legris 18.

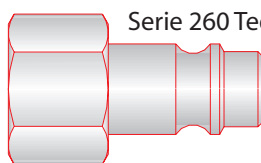

Serie 260 Tedesco

$\text{\textcircled{DN}}$ 7,5 mm

Kompatibilitet: Standard Tedesco, Rectus 25/26, CEJN 320, Camozzi 5180, JWL 520/530, Festo KD serie, TST, Asturo 11140, Legris 25/26, Prevost ERC07.

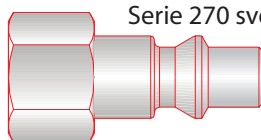

Serie 270 svensk

$\text{\textcircled{DN}}$ 5,5 mm

Kompatibilitet: Standard Svedese, Rectus 14, Rectus 22, CEJN 300, ARO 210, Parker 50, Orion 44510, JWL 522/523, Asturo 11110, Legris 14/24, Prevost ARM06.



Serie 410-510

Kompatibilitet: Staubli



Serie 660 europæisk

$\text{\textcircled{DN}}$ 7,5 mm

Kompatibilitet: Standard Tedesco, Rectus 25/26, CEJN 320, Camozzi 5180, JWL 520/530, Festo KD serie, TST, Asturo 11140, Legris 25/26, Prevost ERC07.



Serie 670 svensk

$\text{\textcircled{DN}}$ 5,5 mm

Kompatibilitet: Standard Svedese, Rectus 14, Rectus 22, CEJN 300, ARO 210, Parker 50, Orion 44510, JWL 522/523, Asturo 11110, Legris 14/24, Prevost ARM06.

MATERIALEOVERSIGT

SERIE 200 - 270

- 1. Forniklet messing krop
- 2. Fjeder, AISI 302
- 3. Forniklet messing lukkestyrer
- 4+5+6. NBR 70 O-ring
- 7. Forniklet messing koblingring
- 8. Omløber, AISI 302
- 9. Kugle, AISI 420
- 10. Forniklet messing udløserring
- 11. Forniklet messing krop
- 12. Forniklet messing prop

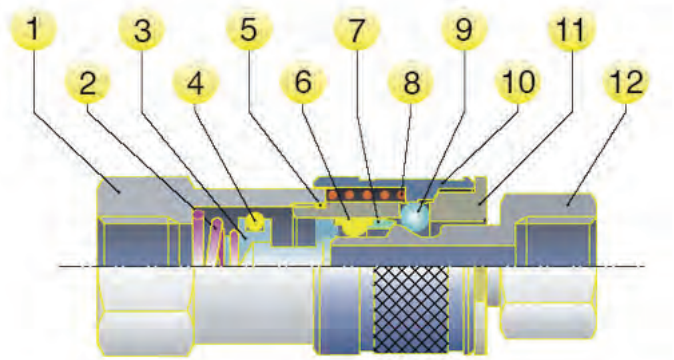

SERIE 410 - 510

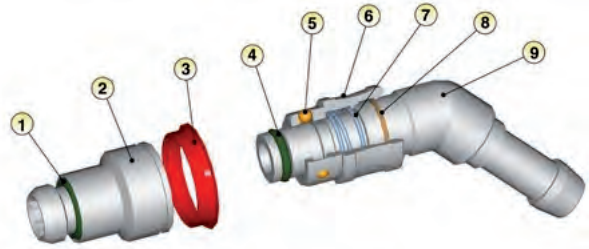

- 1+4. FKM O-ring
- 2. Forniklet messing studs
- 3. PA66 ring
- 5. Kugle, AISI 420
- 6. Forniklet messing udløserring
- 7. Fjeder, AISI 302
- 8. Bronze griber
- 9. Forniklet messing krop

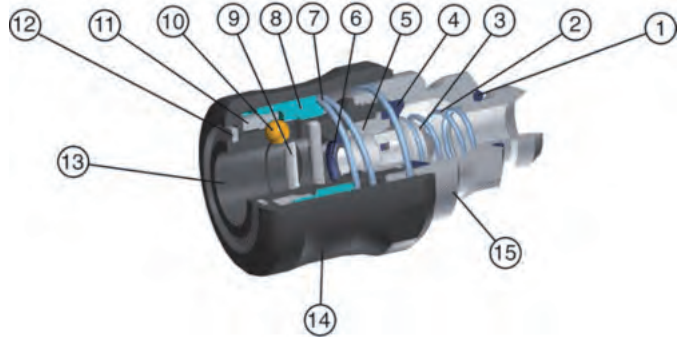

SERIE 660 - 670

- 1+6. NBR 70 O-ring
- 2+7. Fjeder, AISI 302
- 3. Forniklet messing lukkestyrer
- 4. NBR pakning
- 5. Forniklet messing ring
- 8. Forniklet messing aksel
- 9. Plast ring
- 10. Kugle, AISI 420
- 11. Kugle holder ring, AISI 303
- 12. Griber, AISI 302
- 13. Plast krop
- 14. Plast udløserring
- 15. Forniklet messing bagpart



	SERIE 200	SERIE 210	SERIE 220	SERIE 230	SERIE 240	SERIE 260	SERIE 270	SERIE 410-510	SERIE 660	SERIE 670
	0 - 10 bar	0 - 12 bar	0 - 16 bar	0 - 16 bar	0 - 25 bar	0 - 16 bar	0 - 12 bar	0 - 15 bar	-1 - 15 bar	-1 - 15 bar
	-18°C +80°C							0°C +110°C	-18°C +80°C	

FLOW KARAKTERISTIK FOR AUTOMATISKE LYNKOBLINGER 100 - 200 SERIEN

Flow karakteristisk med udstødning
til atmosfære

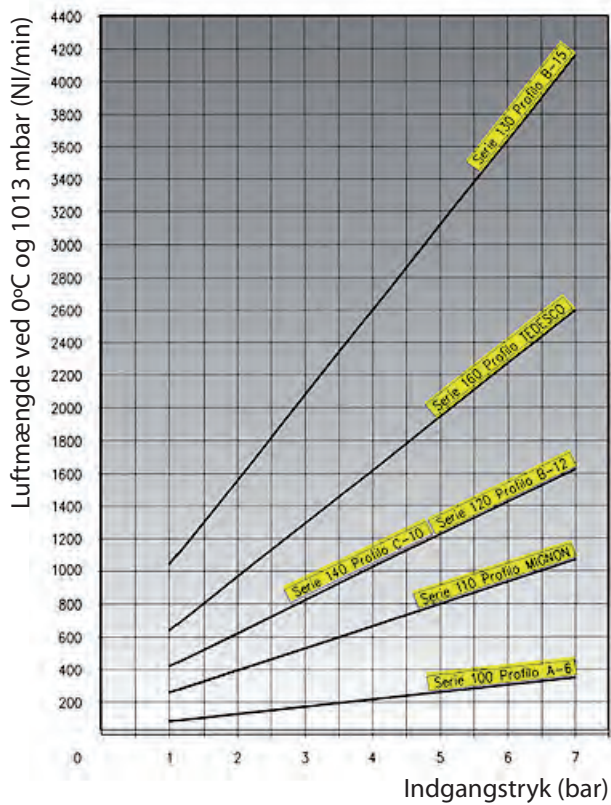

Flow karakteristisk med 1 bar tryktab

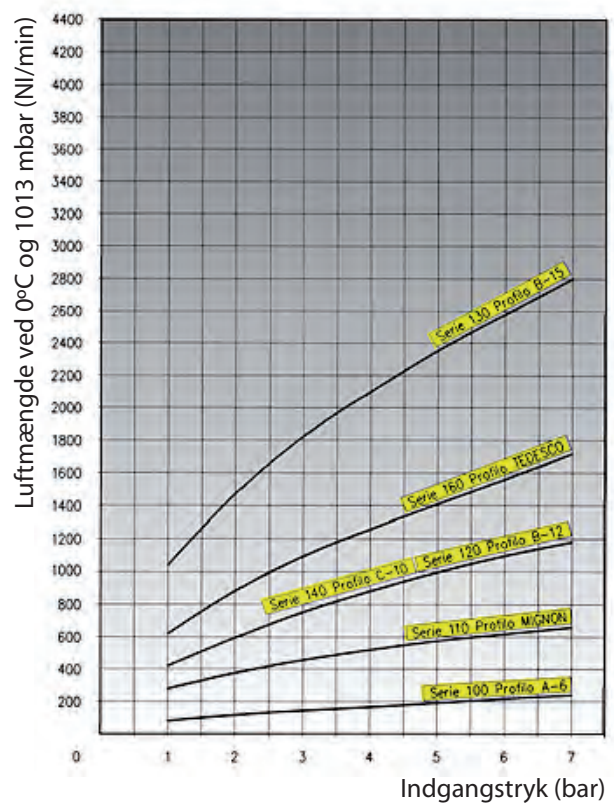

LYNKOBLING SERIE 200 MINI



0-10 bar



-18°C til +80°C



ISO 6150 A-6



Flow: 200L/min (6bar)

Kompatibilitet: Norma UNI ISO 6150 A-6

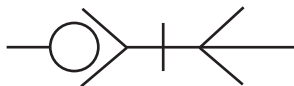

PROFIL SKALA 1:1

Lynkobling push-on

MESSING



Varenr.	Ø/ø	DKK
MA104-1	4/2,7	48,15
MA104-2	6/4	48,15

Nippel push-on

MESSING



Varenr.	Ø/ø	DKK
MA204-1	4/2,7	13,40
MA204-2	6/4	13,40

Lynkobling m. slangestuds

MESSING

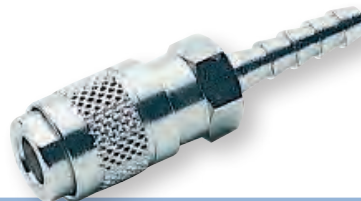

Varenr.	Ø	DKK
MA105-1	4	45,55
MA105-2	6	45,55

Nippel m. slangestuds

MESSING



Varenr.	Ø	DKK
MA205-1	4	9,85
MA205-2	6	9,85

Lynkobling m. udv. gev.

MESSING - BSPP



Varenr.	BSPP	DKK
MA101-1	1/8"	41,95

Nippel m. udv. gevind

MESSING - BSPP



Varenr.	BSPP	DKK
MA201-1	1/8"	7,70

Lynkobling m. indiv. gev.

MESSING - BSPP



Varenr.	BSPP	DKK
MA102-1	1/8"	45,55

Nippel m. indiv. gevind

MESSING - BSPP



Varenr.	BSPP	DKK
MA202-1	1/8"	7,70

Ved push-on sættes slangen ned over en midterstuds med krave, der udvider slangen. Omløberens hul passer til den ikke-udvidede slange og klemmer derfor slangen fast, når den skrues på. Løsnes omløberen, kan slangen fjernes igen.

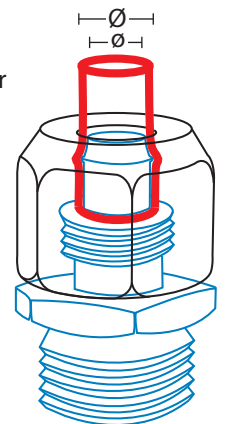

LYNKOBLING SERIE 210 MIGNON



0-12 bar



-18°C til +80°C



Flow: 200L/min (6bar)

Kompatibilitet: Mignon, Rectus 21, Rectus 90, Camozzi 5150, Asturo 11400, Legris 21

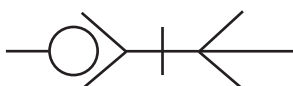

PROFIL SKALA 1:1

Lynkobling m. udv. gev.

MESSING - BSPP



Varenr.	BSPP	DKK
MA111-1	1/8"	48,15
MA111-2	1/4"	48,15
MA111-3	3/8"	49,50

Lynkobling m. udv. gev.

MESSING - BSPP



Skotgennemføring		
Varenr.	BSPP	DKK
MA116-1	1/8"	65,55
MA116-2	1/4"	66,10
MA116-3	3/8"	69,90

Lynkobling m. indiv. gev.

MESSING - BSPP



Varenr.	BSPP	DKK
MA112-1	1/8"	49,85
MA112-2	1/4"	49,85
MA112-3	3/8"	53,20

Lynkobling push-on

MESSING



Varenr.	Ø/ø	DKK
MA114-1	6/4	52,40
MA114-2	8/6	52,40

Lynkobling push-on

MESSING



Skotgennemføring		
Varenr.	Ø/ø	DKK
MA118-1	6/4	69,35
MA118-2	8/6	70,75

Lynkobling m. slangestuds

MESSING



Varenr.	Ø	DKK
MA115-1	4	49,50
MA115-2	6	49,50
MA115-3	8	49,50

Lynkobling m. slangestuds

MESSING



Skotgennemføring		
Varenr.	Ø	DKK
MA119-1	4	65,55
MA119-2	6	66,10
MA119-3	8	67,75

Lynkobling push-on

MESSING



Aflastningsfjeder		
Varenr.	Ø/ø	DKK
MA113-1	6/4	61,15
MA113-2	8/6	61,15

Lynkobling push-on

MESSING



Skotgennemføring, aflastfeder

Varenr.	Ø/ø	DKK
MA117-1	6/4	76,70
MA117-2	8/6	78,35

Nippel m. slangestuds

MESSING



Varenr.	Ø	DKK
MA215-1	4	8,80
MA215-2	6	8,80
MA215-3	8	10,65

Nippel m. udv. gevind

MESSING - BSPP



Varenr.	BSPP	DKK
MA211-1	1/8"	8,35
MA211-2	1/4"	10,05
MA211-3	3/8"	13,40

Nippel push-on

MESSING



Aflastningsfeder

Varenr.	Ø/ø	DKK
MA213-1	6/4	21,00
MA213-2	8/6	22,05

Nippel m. indiv. gevind

MESSING - BSPP



Varenr.	BSPP	DKK
MA212-1	1/8"	8,35
MA212-2	1/4"	10,05
MA212-3	3/8"	13,40

Ved push-on sættes slangen ned over en midterstuds med krave, der udvider slangen. Omløberens hul passer til den ikke-udvidede slange og klemmer derfor slangen fast, når den skrues på. Løsnes omløberen, kan slangen fjernes igen.

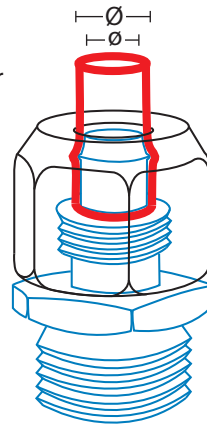

Nippel push-on

MESSING



Varenr.	Ø/ø	DKK
MA214-1	6/4	13,80
MA214-2	8/6	14,35

LYNKOBLING SERIE 210 MIGNON DOBBELT



0-12 bar



-18°C til +80°C



Flow: 200L/min (6bar)

Kompatibilitet:

Mignon, Rectus 21, Rectus 90, Camozzi
5150, Asturo 11400, Legris 21

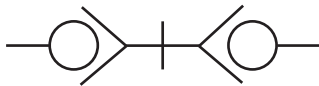

PROFIL SKALA 1:1

Lynkobling m. udv. gev.

MESSING - BSPP



Varenr.	BSPP	DKK
MA181-1	1/8"	53,50
MA181-2	1/4"	53,75
MA181-3	3/8"	58,15

Lynkobling m. indiv. gev.

MESSING - BSPP



Varenr.	BSPP	DKK
MA182-1	1/8"	58,15
MA182-2	1/4"	58,75
MA182-3	3/8"	61,45

Lynkobling push-on

MESSING



Varenr.	Ø/ø	DKK
MA184-1	6/4	60,05
MA184-2	8/6	61,70

Lynkobling m. slangestuds

MESSING



Varenr.	Ø	DKK
MA185-1	4	58,45
MA185-2	6	58,45
MA185-3	8	58,45

Lynkobling push-on

MESSING



Aflastningsfjeder

Varenr.	Ø/ø	DKK
MA183-1	6/4	67,75
MA183-2	8/6	68,50

Nippel m. udv. gevind

MESSING - BSPP



Varenr.	BSPP	DKK
MA281-1	1/8"	30,70
MA281-2	1/4"	32,95
MA281-3	3/8"	35,20

Nippel m. indiv. gevind

MESSING - BSPP



Varenr.	BSPP	DKK
MA282-1	1/8"	35,75
MA282-2	1/4"	38,05
MA282-3	3/8"	39,10

Nippel push-on

MESSING



Varenr.	Ø/ø	DKK
MA283-1	6/4	42,75
MA283-2	8/6	43,40

Nippel m. slangestuds

MESSING



Varenr.	Ø	DKK
MA285-1	4	32,10
MA285-2	6	32,10
MA285-3	8	35,50

Nippel push-on

MESSING



Aflastningsfjeder

Varenr.	Ø/ø	DKK
MA284-1	6/4	35,50
MA284-2	8/6	36,05

Ved push-on sættes slangen ned over en midterstuds med krave, der udvider slangen. Omløberens hul passer til den ikke-udvidede slange og klemmer derfor slangen fast, når den skrues på. Løsnes omløberen, kan slangen fjernes igen.

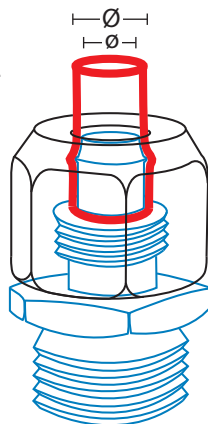

LYNKOBLING SERIE 220 NORMA



0-16 bar



-18°C til +80°C



ISO 6150 B-12



Flow: 1100L/min (6 bar)

Kompatibilitet: Norma UNI ISO 6150
B-12, Rectus 23, Rectus 24, US-MIL SPEC
C-4109, Hansen 3000, Gromelle 600,
Parker 30 1/4, CEJN 310, JWL 521/531,
Nordgren Dynaquip DC3

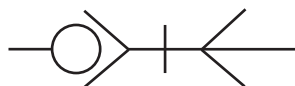

PROFIL SKALA 1:1

Lynkobling m. udv. gev.

MESSING - BSPP



Varenr.	BSPP	DKK
MA121-1	1/4"	62,80
MA121-2	3/8"	62,80
MA121-3	1/2"	68,25

Lynkobling m. indiv. gev.

MESSING - BSPP



Varenr.	BSPP	DKK
MA122-1	1/4"	66,60
MA122-2	3/8"	66,60
MA122-3	1/2"	71,25

Lynkobling push-on

MESSING



Varenr.	Ø/ø	DKK
MA124-1	6/4	61,15
MA124-2	8/6	63,05
MA124-3	10/8	63,05

Lynkobling m. slangestuds

MESSING



Varenr.	Ø	DKK
MA125-1	6	66,60
MA125-2	8	66,60
MA125-3	10	66,60
MA125-4	12	66,60

Lynkobling push-on

MESSING



Aflastningsfjeder		
Varenr.	Ø/ø	DKK
MA123-1	6/4	76,70
MA123-2	8/6	78,65
MA123-3	10/8	78,65

Nippel m. udv. gevind

MESSING - BSPP



Varenr.	BSPP	DKK
MA221-1	1/4"	13,20
MA221-2	3/8"	15,30
MA221-3	1/2"	22,05

Nippel m. indiv. gevind

MESSING - BSPP

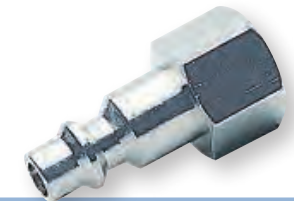

Varenr.	BSPP	DKK
MA222-1	1/4"	13,20
MA222-2	3/8"	15,60
MA222-3	1/2"	22,70

Nippel push-on

MESSING



Varenr.	Ø/ø	DKK
MA224-1	6/4	15,60
MA224-2	8/6	16,15
MA224-3	10/8	19,20
MA224-4	12/10	19,20

Nippel m. slangestuds

MESSING



Varenr.	Ø	DKK
MA225-1	6	10,85
MA225-2	8	11,90
MA225-3	10	13,20
MA225-4	12	14,35

Nippel push-on

MESSING



Aflastningsfjeder

Varenr.	Ø/ø	DKK
MA223-1	6/4	23,85
MA223-2	8/6	24,85
MA223-3	10/8	28,10
MA223-4	12/10	28,10

Ved push-on sættes slangen ned over en midterstuds med krave, der udvider slangen. Omløberens hul passer til den ikke-udvidede slange og klemmer derfor slangen fast, når den skrues på. Løsnes omløberen, kan slangen fjernes igen.

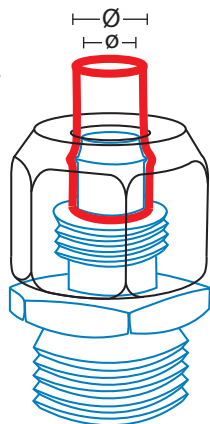

LYNKOBLING SERIE 230 NORMA



0-16 bar



-18°C til +80°C



ISO 6150



Flow: 2600L/min (6bar)

Kompatibilitet: Norma UNI ISO 6150 B-15,
Rectus 30, US_MIL SPEC C-4109, Hansen
4000, Gromelle 90, ARO, Parker 30 3/8

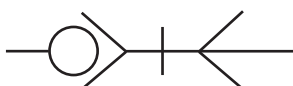

PROFIL SKALA 1:1

Lynkobling m. udv. gev.

MESSING - BSPP



Varenr.	BSPP	DKK
MA131-1	3/8"	74,80
MA131-2	1/2"	74,80

Lynkobling m. indiv. gev.

MESSING - BSPP



Varenr.	BSPP	DKK
MA132-1	3/8"	79,45
MA132-2	1/2"	79,45

Lynkobling push-on

MESSING



Varenr.	Ø/ø	DKK
MA134-1	10/8	75,35
MA134-2	12/10	75,35

Lynkobling m. slangestuds

MESSING



Varenr.	Ø	DKK
MA135-1	8	79,75
MA135-2	10	79,75
MA135-3	12	79,75

Lynkobling push-on

MESSING



Aflastningsfjeder

Varenr.	Ø/ø	DKK
MA133-1	10/8	85,20
MA133-2	12/10	85,20

Nippel m. udv. gevind

MESSING - BSPP



Varenr.	BSPP	DKK
MA231-1	3/8"	16,15
MA231-2	1/2"	22,70

Nippel m. indiv. gevind

MESSING - BSPP



Varenr.	BSPP	DKK
MA232-1	3/8"	17,05
MA232-2	1/2"	24,55

Nippel push-on

MESSING



Varenr.	Ø/ø	DKK
MA234-1	10/8	17,60
MA234-2	12/10	19,20

Nippel m. slangestuds

MESSING



Varenr.	Ø	DKK
MA235-1	8	15,30
MA235-2	10	13,80

Nippel push-on

MESSING



Aflastningsfjeder

Varenr.	Ø/ø	DKK
MA233-1	10/8	28,10
MA233-2	12/10	32,10

Ved push-on sættes slangen ned over en midterstuds med krave, der udvider slangen. Omløberens hul passer til den ikke-udvidede slange og klemmer derfor slangen fast, når den skrues på. Løsnes omløberen, kan slangen fjernes igen.

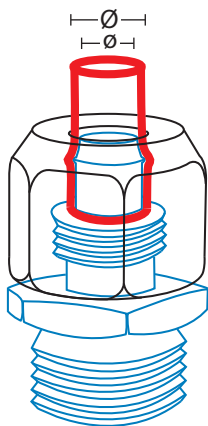

LYNKOBLING SERIE 240 NORMA



0-25 bar



-18°C til +80°C



ISO 6150 C-10



Flow: 1100L/min (6 bar)

Kompatibilitet: Norma UNI ISO 6150 C-10, Rectus 18, Staubli RCS-RBE 6, Oetiker ISO Standard DP 6150, CEJN 291, Gromelle, Legris 18

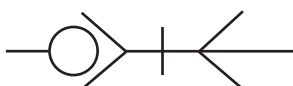

PROFIL SKALA 1:1

Lynkobling m. udv. gev.

MESSING - BSPP



Varenr.	BSPP	DKK
MA141-1	1/4"	59,80
MA141-2	3/8"	59,80
MA141-3	1/2"	64,95

Lynkobling m. indiv. gev.

MESSING - BSPP



Varenr.	BSPP	DKK
MA142-1	1/4"	65,55
MA142-2	3/8"	65,55
MA142-3	1/2"	70,15

Lynkobling push-on

MESSING



Varenr.	Ø/ø	DKK
MA144-1	6/4	59,80
MA144-2	8/6	59,80
MA144-3	10/8	60,90

Lynkobling m. slangestuds

MESSING



Varenr.	Ø	DKK
MA145-1	6	63,65
MA145-2	8	63,65
MA145-3	10	63,65
MA145-4	12	57,90

Lynkobling push-on

MESSING



Aflastningsfjeder

Varenr.	Ø/ø	DKK
MA143-1	6/4	68,00
MA143-2	8/6	68,00
MA143-3	10/8	69,65

Nippel m. udv. gevind

MESSING - BSPP



Varenr.	BSPP	DKK
MA241-1	1/4"	13,40
MA241-2	3/8"	15,30
MA241-3	1/2"	23,60

Nippel m. indiv. gevind

MESSING - BSPP



Varenr.	BSPP	DKK
MA242-1	1/4"	13,80
MA242-2	3/8"	15,60
MA242-3	1/2"	24,25

Nippel push-on

MESSING



Varenr.	Ø/ø	DKK
MA244-1	6/4	16,15
MA244-2	8/6	17,60
MA244-3	10/8	18,95

Nippel m. slangestuds

MESSING



Varenr.	Ø	DKK
MA245-1	6	10,25
MA245-2	8	11,70
MA245-3	10	12,90
MA245-4	12	13,40

Nippel push-on

MESSING



Aflastningsfjeder

Varenr.	Ø/ø	DKK
MA243-1	6/4	24,25
MA243-2	8/6	26,00
MA243-3	10/8	28,10

Ved push-on sættes slangen ned over en midterstuds med krave, der udvider slangen. Omløberens hul passer til den ikke-udvidede slange og klemmer derfor slangen fast, når den skrues på. Løsnes omløberen, kan slangen fjernes igen.

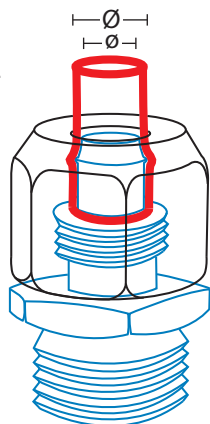

LYNKOBLING SERIE 260 TEDESCO

DE MEST BRUGTE KOBLINGER I NORDEN



0-16 bar



-18°C til +80°C



Flow: 2600L/min (6 bar)

Kompatibilitet: Standard Tedesco, Rectus 25/26, CEJN 320, Camozzi 5180, JWJ 520/530, Festo KD serie, TST, Asturo 11140, Legris 25/26, Prevost ERC07

Mest brugte luftkobling i Nordeuropa.

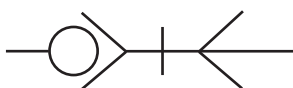

PROFIL SKALA 1:1

Lynkobling m. udv. gev.

MESSING - BSPP



Varenr.	BSPP	DKK
MA161-1	1/4"	71,55
MA161-2	3/8"	73,45
MA161-3	1/2"	78,65

Lynkobling m. indiv. gev.

MESSING - BSPP



Varenr.	BSPP	DKK
MA162-1	1/4"	66,10
MA162-2	3/8"	66,10
MA162-3	1/2"	71,00

Lynkobling push-on

MESSING



Varenr.	Ø/ø	DKK
MA164-1	6/4	67,75
MA164-2	8/6	69,10
MA164-3	10/8	69,10

Lynkobling m. slangestuds

MESSING



Varenr.	Ø	DKK
MA165-1	6	66,10
MA165-2	8	66,10
MA165-3	10	66,10
MA165-4	12	66,10

Lynkobling push-on

MESSING



Aflastningsfjeder		
Varenr.	Ø/ø	DKK
MA163-1	6/4	75,35
MA163-2	8/6	78,35
MA163-3	10/8	78,35

Nippel m. udv. gevind

MESSING - BSPP



Varenr.	BSPP	DKK
MA261-1	1/4"	17,15
MA261-2	3/8"	18,35
MA261-3	1/2"	22,25

Nippel m. indiv. gevind

MESSING - BSPP



Varenr.	BSPP	DKK
MA262-1	1/4"	17,85
MA262-2	3/8"	20,05
MA262-3	1/2"	21,15

Nippel push-on

MESSING



Varenr.	Ø/ø	DKK
MA264-1	6/4	15,05
MA264-2	8/6	15,85
MA264-3	10/8	17,05

Nippel m. slangestuds

MESSING



Varenr.	Ø	DKK
MA265-1	6	9,60
MA265-2	8	11,80
MA265-3	10	12,20
MA265-4	12	14,70

Nippel push-on

MESSING



Aflastningsfjeder

Varenr.	Ø/ø	DKK
MA263-1	6/4	22,45
MA263-2	8/6	23,30
MA263-3	10/8	25,15

Ved push-on sættes slangen ned over en midterstuds med krave, der udvider slangen. Omløberens hul passer til den ikke-udvidede slange og klemmer derfor slangen fast, når den skrues på. Løsnes omløberen, kan slangen fjernes igen.

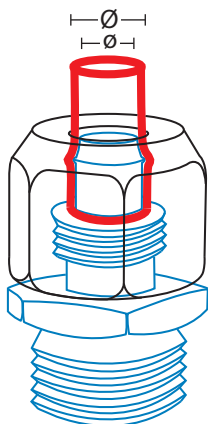

LYNKOBLING SERIE 520 JWL



1-35 bar



-20°C til +60°C



JWL er produceret med meget høj kvalitet og et program med fantastisk stabilitet.

Standard: EURO

Flowdiameter: 7,8mm

Kompatibilitet: Cejn 320, Hansen Auto Flo 24, Proquix 1420 & 1421, Legris 94xx A, Oetiker SC Series C, Prevost ESC 07 / ERC 07, Rectus-Tema 25, 26 & 1600.

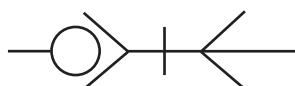

PROFIL SKALA 1:1



JWL lynkobling m. indv. gev.

STÅL - BSPP



Varenr.	BSPP	Type	DKK
JT50-2	1/4"	520	175,50
JT50-3	3/8"	520	175,50
JT50-4	1/2"	520	192,25

JWL nippel m. indv. gevind

STÅL - BSPP



Varenr.	BSPP	Type	DKK
JT53-2	1/4"	520	36,55
JT53-3	3/8"	520	49,40
JT53-4	1/2"	520	84,10

JWL lynkobling m. udv. gev.

STÅL - BSPT



Varenr.	BSPT	Type	DKK
JT51-2	1/4"	520	175,50
JT51-3	3/8"	520	175,50
JT51-4	1/2"	520	192,25

JWL nippel m. udv. gevind

STÅL - BSPT



Varenr.	BSPT	Type	DKK
JT54-2	1/4"	520	39,90
JT54-3	3/8"	520	49,15
JT54-4	1/2"	520	84,10

JWL lynkobling m. slangestuds

STÅL



Varenr.	Ø	Type	DKK
JT52-6	6	520	175,50
JT52-8	8	520	175,50
JT52-10	10	520	175,75
JT52-13	13	520	192,25

JWL nippel m. slangestuds

STÅL

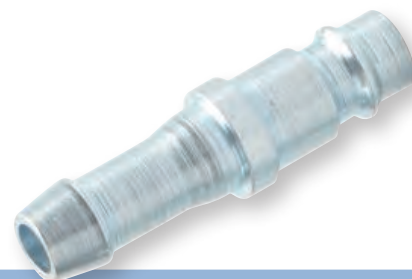

Varenr.	Ø	Type	DKK
JT55-6	6	520	39,90
JT55-8	8	520	39,90
JT55-10	10	520	49,15
JT55-13	13	520	49,15

LYNKOBLING SERIE 270 SVENSK



0-16 bar



-18°C til +80°C



Flow: 600L/min (6 bar)

Kompatibilitet: Standard Svedese, Rectus 14, Rectus 22, CEJN 300, ARO 210, Parker 50, Orion 44510, JWL 522/523, Asturo 11110, Legris 14/24, Prevost ARM06

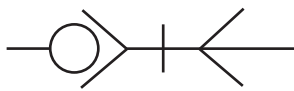

PROFIL SKALA 1:1

Lynkobling m. udv.gev.

MESSING - BSPP



Varenr.	BSPP	DKK
MA191-1	1/4"	64,20
MA191-2	3/8"	64,20
MA191-3	1/2"	68,85

Lynkobling m. indiv. gev.

MESSING - BSPP



Varenr.	BSPP	DKK
MA192-1	1/4"	68,50
MA192-2	3/8"	68,50
MA192-3	1/2"	72,90

Lynkobling push-on

MESSING



Varenr.	Ø/ø	DKK
MA194-1	6/4	6298,50
MA194-2	8/6	64,45
MA194-3	10/8	64,45

Lynkobling m. slangestuds

MESSING



Varenr.	Ø	DKK
MA195-1	6	68,50
MA195-2	8	68,50
MA195-3	10	68,50
MA195-4	12	68,50

Lynkobling push-on

MESSING



Aflastningsfeder		
Varenr.	Ø/ø	DKK
MA193-1	6/4	71,00
MA193-2	8/6	73,45
MA193-3	10/8	80,85

Nippel m. udv. gevind

MESSING - BSPP



Varenr.	BSPP	DKK
MA271-1	1/4"	12,55
MA271-2	3/8"	14,35
MA271-3	1/2"	20,70

Nippel m. indiv. gevind

MESSING - BSPP



Varenr.	BSPP	DKK
MA272-1	1/4"	13,20
MA272-2	3/8"	15,05
MA272-3	1/2"	21,80

Nippel push-on

MESSING



Varenr.	Ø/ø	DKK
MA274-1	6/4	15,05
MA274-2	8/6	15,85
MA274-3	10/8	18,20

Nippel m. slangestuds

MESSING



Varenr.	Ø	DKK
MA275-1	6	10,65
MA275-2	8	11,80
MA275-3	10	13,20
MA275-4	12	14,10

Nippel push-on

MESSING



Aflastningsfeder

Varenr.	Ø/ø	DKK
MA273-1	6/4	20,80
MA273-2	8/6	21,70
MA273-3	10/8	26,95

Ved push-on sættes slangen ned over en midterstuds med krave, der udvider slangen. Omløberens hul passer til den ikke-udvidede slange og klemmer derfor slangen fast, når den skrues på. Løsnes omløberen, kan slangen fjernes igen.

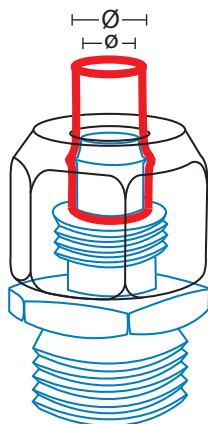

LYNKOBLING SERIE 410-510



Max 15 bar



0°C til +110°C



Flow:

Kompatibilitet: Staubli

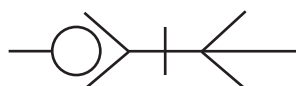

PROFIL SKALA 1:1

Nippel 45° slangestuds

MESSING



Varenr.	Ø	DKK
MA416-1	8	119,25
MA416-2	10	119,25
MA416-3	12	119,25

Lynkobling m. udv. gev.

MESSING - BSPP

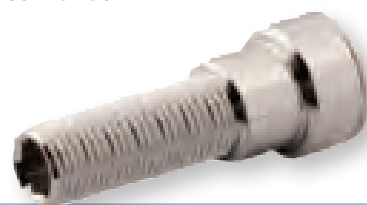

Varenr.	BSPP	L	DKK
MA512-1	1/8"	50mm	82,50
MA512-2	1/8"	100mm	137,25
MA512-3	1/8"	150mm	175,75
MA512-4	1/8"	200mm	225,50
MA512-5	1/4"	50mm	82,50
MA512-6	1/4"	100mm	137,25
MA512-7	1/4"	150mm	175,75
MA512-8	1/4"	200mm	225,50
MA512-9	3/8"	50mm	82,50
MA512-10	3/8"	100mm	137,25
MA512-11	3/8"	150mm	175,75
MA512-12	3/8"	200mm	225,50

Lynkobling indvendig gevind

MESSING - BSPP



Varenr.	BSPP	DKK
MA412-1	1/4"	86,55

Nippel 90° slangestuds

MESSING



Varenr.	Ø	DKK
MA418-1	8	110,25
MA418-2	10	110,25
MA418-3	12	110,25

Nippel med slangestuds

MESSING



Varenr.	Ø	DKK
MA415-1	8	88,75
MA415-2	10	88,75
MA415-3	12	88,75

Lynkobling m. udv. gev.

MESSING - BSPP



Varenr.	BSPP	DKK
MA511-1	1/8"	20,30
MA511-2	1/4"	20,30
MA511-3	3/8"	23,30

Identifikationsring

PA (POLYAMID)



Varenr.	Str.	farve	DKK
MA513R-1	1/8"	rød/red	5,45
MA513R-2	1/4"	rød/red	5,45
MA513R-3	3/8"	rød/red	5,45
MA513B-1	1/8"	blå/blue	5,45
MA513B-2	1/4"	blå/blue	5,45
MA513B-3	3/8"	blå/blue	5,45

LYNKOBLING SERIE 660 EUROPÆISK



1-15 bar



-18°C til +80°C



Flow: 1000L/min (6 bar)

Kompatibilitet: Standard Tedesco, Rectus 25/26, CEJN 320, Camozzi 5180, JWL 520/530, Festo KD serie, TST, Asturo 11140, Legris 25/26, Prevost ERC07

To-trinskobling:
Trin 1: trykdøsning
Trin 2: afkobling

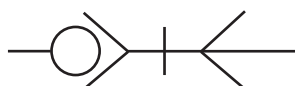

PROFIL SKALA 1:1

Lynkobling push-on

MESSING



Sikkerhedskobling

Varenr.	Ø/ø	DKK
MA664-1	6/4	187,50
MA664-2	8/6	187,50
MA664-3	10/6,5	188,00
MA664-4	10/8	188,00
MA664-5	12/8	197,00
MA664-6	12/10	197,00

Nippel m. indiv. gevind

MESSING - BSPP



Varenr.	BSPP	DKK
MA262-1	1/4"	17,85
MA262-2	3/8"	20,05
MA262-3	1/2"	21,15

Lynkobling m. udv. gev.

MESSING - BSPP



Sikkerhedskobling

Varenr.	BSPP	DKK
MA661-1	1/4"	181,75
MA661-2	3/8"	183,75
MA661-3	1/2"	193,75

Lynkobling m. slangestuds

MESSING



Sikkerhedskobling

Varenr.	Ø	DKK
MA665-1	6	185,75
MA665-2	8	185,75
MA665-3	10	185,75
MA665-4	12	188,50

Nippel m. slangestuds

MESSING

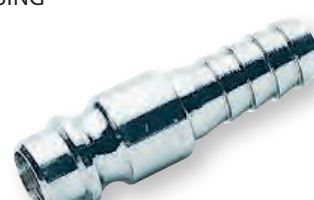

Varenr.	Ø	DKK
MA265-1	6	9,60
MA265-2	8	11,80
MA265-3	10	12,20
MA265-4	12	14,70

Lynkobling m. indiv. gev.

MESSING - BSPP



Sikkerhedskobling

Varenr.	BSPP	DKK
MA662-1	1/4"	185,75
MA662-2	3/8"	190,25
MA662-3	1/2"	195,75

Nippel m. udv. gevind

MESSING - BSPP



Varenr.	BSPP	DKK
MA261-1	1/4"	17,15
MA261-2	3/8"	18,35
MA261-3	1/2"	22,25

Aflastningshylse

EPDM



Varenr.	Str.	DKK
MA628-1	6/8/10/12	9,60

LYNKOBLING SERIE 670 SVENSK



1-15 bar



-18°C til +80°C



Flow: 800L/min (6 bar)

Kompatibilitet: Standard Svedese, Rectus 14, Rectus 22, CEJN 300, ARO 210, Parker 50, Orion 44510, JWL 522/523, Asturo 11110, Legris 14/24, Prevost ARM06

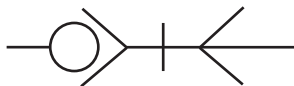

PROFIL SKALA 1:1

Lynkobling push-on

MESSING



Sikkerhedskobling

Varenr.	Ø/ø	DKK
MA674-1	6/4	199,00
MA674-2	8/6	199,00
MA674-3	10/6,5	199,50
MA674-4	10/8	199,50
MA674-5	12/8	209,00
MA674-6	12/10	209,00

Nippel m. indiv. gevind

MESSING - BSPP



Varenr.	BSPP	DKK
MA272-1	1/4"	13,20
MA272-2	3/8"	15,05
MA272-3	1/2"	21,80

Nippel m. slangestuds

MESSING



Varenr.	Ø	DKK
MA275-1	6	10,65
MA275-2	8	11,80
MA275-3	10	13,20
MA275-4	12	14,10

Lynkobling m. udv. gev.

MESSING - BSPP



Sikkerhedskobling

Varenr.	BSPP	DKK
MA671-1	1/4"	192,50
MA671-2	3/8"	194,75
MA671-3	1/2"	205,25

Lynkobling m. slangestuds

MESSING



Sikkerhedskobling

Varenr.	Ø	DKK
MA675-1	6	196,75
MA675-2	8	196,75
MA675-3	10	196,75
MA675-4	12	200,00

Lynkobling m. indiv. gev.

MESSING - BSPP



Sikkerhedskobling

Varenr.	BSPP	DKK
MA672-1	1/4"	196,75
MA672-2	3/8"	201,50
MA672-3	1/2"	207,75

Nippel m. udv. gevind

MESSING - BSPP



Varenr.	BSPP	DKK
MA271-1	1/4"	12,55
MA271-2	3/8"	14,35
MA271-3	1/2"	20,70

LYNKOBLING SERIE 800 MINI



0-10 bar



-18°C til +80°C



Serie af mini lynkoblinger med slangetilslutning ned til 4/2,7mm og med M5 eller 1/8" gevind.

Flow: 236L/min (6 bar)

Kompatibilitet: Serto KA202 og Serto coT 203

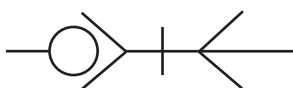

PROFIL SKALA 1:1

Lynkobling m. udv. gev.

MESSING - BSPP



Varenr.	BSPP	DKK
MA701-1	M5	50,65
MA701-2	1/8"	50,65

Nippel m. udv. gevind

MESSING - BSPP



Varenr.	BSPP	DKK
MA801-1	M5	8,15
MA801-2	1/8"	8,15

Lynkobling m. indiv. gev.

MESSING - BSPP



Varenr.	BSPP	DKK
MA702-1	M5	54,00
MA702-2	1/8"	54,00

Nippel m. indiv. gevind

MESSING - BSPP



Varenr.	BSPP	DKK
MA802-1	M5	8,15
MA802-2	1/8"	8,15

Lynkobling push-on

MESSING



Varenr.	Ø/ø	DKK
MA704-1	4/2,7	56,25
MA704-2	6/4	56,25

Nippel push-on

MESSING

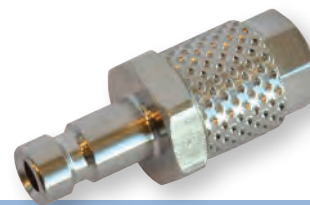

Varenr.	Ø/ø	DKK
MA804-1	4/2,7	14,40
MA804-2	6/4	14,40



524

LYNKOBLING ISO B



Se tekst



AISI 316: -20°C til +200°C
Messing: -18°C til +80°C



ISO B



Flow (6 bar): se hver varelinie

Fordele: Robust konstruktion, enhånds-udløsning.

Kompatibilitet: PARKER, HANSEN HK (ISO 7241 Serie B).

Max tryk AISI 316:

1/4" = 250 bar

3/8" = 230 bar

1/2" = 200 bar

3/4" = 160 bar

Max tryk messing:

- 150 bar

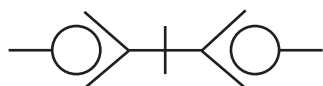

ISO B lynkobling m. indv. gevind

AISI 316 / VITON - BSPP



Varenr.	BSPP	L/min	DKK
B111-1	1/8"	2	215,00
B111-2	1/4"	4.5	303,25
B111-3	3/8"	12.5	399,00
B111-4	1/2"	27	577,00
B111-5	3/4"	53	965,25
B111-6	1"	110	1190,75

ISO B nippel m. indv. gevind

AISI 316 / VITON - BSPP



Varenr.	BSPP	L/min	DKK
B112-1	1/8"	2	121,50
B112-2	1/4"	4.5	138,00
B112-3	3/8"	12.5	172,50
B112-4	1/2"	27	234,00
B112-5	3/4"	53	442,75
B112-6	1"	110	558,25

ISO B kobling m. indv. gevind

MESSING / NBR - BSPP



Varenr.	BSPP	L/min	DKK
M300-1	1/8"	2	74,55
M300-2	1/4"	4.5	85,20
M300-3	3/8"	12.5	140,50
M300-4	1/2"	27	224,25
M300-5	3/4"	53	358,25
M300-6	1"	110	614,75

ISO B nippel m. indv. gevind

MESSING / NBR - BSPP



Varenr.	BSPP	L/min	DKK
M301-1	1/8"	2	32,40
M301-2	1/4"	4.5	37,15
M301-3	3/8"	12.5	60,65
M301-4	1/2"	27	96,40
M301-5	3/4"	53	154,25
M301-6	1"	110	263,25

Støvhætte han ISO B

GUMMI



Varenr.	Dim	DN	DKK
M309-2	1/4"	6	57,70
M309-3	3/8"	13	57,70
M309-4	1/2"	13	59,75
M309-5	3/4"	20	70,05

Støvprop hun ISO B

GUMMI



Varenr.	Dim	DN	DKK
M310-2	1/4"	6	57,70
M310-3	3/8"	10	57,70
M310-4	1/2"	10	65,95
M310-5	3/4"	20	70,05

LYNKOBLING PLASTIK



Max 14 bar



-20°C til +110°C



Lynkobling med forskellige tilslutninger. Kobling produceret af Acetal med rustfri fjeder og med NBR O-ring. Kan bruges både til luft og vand.

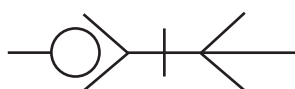

Lynkobling m. indv. gevind

POM (ACETAL) - BSPP



Varenr.	BSPP	DKK
A27-1	1/4"	90,10

Nippel m. indv. gevind

POM (ACETAL) - BSPP



Varenr.	BSPP	DKK
A28-2	1/4"	27,25

Nippel m. udv. gevind

POM (ACETAL) - BSPT



Varenr.	BSPT	DKK
A28-1	1/4"	27,25

Nippel m. slangestuds

POM (ACETAL)



Varenr.	Ø	DKK
A28-3	5	27,25
A28-4	6	27,25
A28-5	8	27,25
A28-6	10	27,25
A28-7	12	27,25

JWL KOBLINGER OG TRYKLUFTHVÆRNSPISTOLER



Bredt program af JWL blæsepistoler og tilbehør. JWL er produceret med meget høj kvalitet og et program med fantastisk stabilitet.

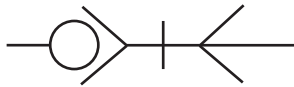

PROFIL SKALA 1:1

JWL lynkobling m. udv. gev. STÅL - BSPT



Varenr.	BSPT	Type	DKK
JT51-2	1/4"	520	175,50
JT51-3	3/8"	520	175,50
JT51-4	1/2"	520	192,25

JWL nippel m. indv. gevind STÅL - BSPP



Varenr.	BSPP	Type	DKK
JT53-2	1/4"	520	36,55
JT53-3	3/8"	520	49,40
JT53-4	1/2"	520	84,10

JWL lynkobling m. indv. gev. STÅL - BSPP



Varenr.	BSPP	Type	DKK
JT50-2	1/4"	520	175,50
JT50-3	3/8"	520	175,50
JT50-4	1/2"	520	192,25

JWL nippel m. udv. gevind STÅL - BSPT



Varenr.	BSPT	Type	DKK
JT54-2	1/4"	520	39,90
JT54-3	3/8"	520	49,15
JT54-4	1/2"	520	84,10

JWL lynkobling m. slangestuds STÅL



Varenr.	Ø	Type	DKK
JT52-6	6	520	175,50
JT52-8	8	520	175,50
JT52-10	10	520	175,75
JT52-13	13	520	192,25

JWL nippel m. slangestuds STÅL



Varenr.	Ø	Type	DKK
JT55-6	6	520	39,90
JT55-8	8	520	39,90
JT55-10	10	520	49,15
JT55-13	13	520	49,15

JWL blæsepistol m. bøjet rør

BSPP



-10°C til +80°C, 8mm rør

Varenr.	BSPP	DKK
JT60-1	1/4"	177,75

Max 16 bar - 380L/min (8 bar)

JWL blæsepistol m. lige rør

BSPP



-10°C til +80°C, 8mm rør

Varenr.	BSPP	L	DKK
JT61-1	1/4"	0,3m	214,00
JT61-2	1/4"	0,5m	230,75
JT61-4	1/4"	1,0m	286,00
JT61-5	1/4"	1,5m	1839,75
JT61-6	1/4"	2,0m	2092,00

Max 16 bar - 380L/min (8 bar)

JWL rensespistol

BSPP



Kunststofdyse

Varenr.	BSPP	L	Vol.	DKK
JT62-1	1/4"	150mm	1,2L	619,75
JT62-2	1/4"	200mm	1,2L	619,75

JWL vaskepistol

BSPP



Varenr.	BSPP	DKK
JT63-1	1/4"	595,75

JWL bremseudluffer

BSPP



Standard med beholder

Varenr.	BSPP	Vol.	DKK
JT64-1	1/4"	1,2L	1150,75
JT64-2	1/4"	2,0L	1271,25

JWL bremseudluffer

BSPP



Til motorcykel med beholder

Varenr.	BSPP	Vol.	DKK
JT65-1	1/4"	1,2L	1203,25

JWL boldpistol inkl. pumpe nål

BSPP



Varenr.	BSPP	DKK
JT66-1	1/4"	312,50

JWL universal pumpepistol

BSPP



8mm bøjet rør til cykler

Varenr.	BSPP	DKK
JT67-1	1/4"	307,75

JWL pumpepistol m/manometer

BSPP



0,5m slange

Varenr.	BSPP	Ø	DKK
JT68-1	1/4"	63	800,25
JT68-2	1/4"	80	913,00

JWL sandblæser med beholder

BSPP



Varenr.	BSPP	Vol.	DKK
JT69-1	1/4"	1,2L	692,00

JWL sandblæsesæt

BSPP

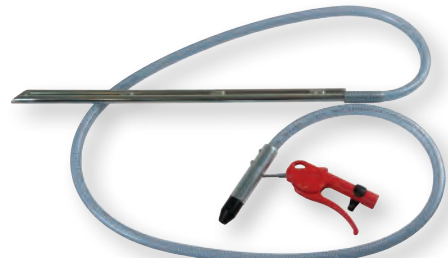

Varenr.	BSPP	DKK
JT70-1	1/4"	1547,25

JWL sprøjte m/kunststofsugerør

BSPP



Passer på engangsdåser

Varenr.	BSPP	DKK
JT71-1	1/4"	607,75

JWL hulrumsslange sæt BSPP



Med 2 sugerør og hulrumsslange

Varenr.	Str.	DKK
JT72-1	-	1736,75

JWL standard malersprøjte



1L underkop

Varenr.	DS	DKK
JT76-1	1,6mm	1765,50
JT76-2	2,0mm	1765,50

DS = dysestørrelse

JWL spiralslange PUR (POLYURETHAN)



Med JWL 530 kobling+nippel, max 10bar

Varenr.	ø × Ø	Type	L	DKK
JT80-1-1	4 × 6	530	1m	715,75
JT80-2-1	5 × 8	530	1m	800,25
JT80-2-2	5 × 8	530	2m	833,75
JT80-2-4	5 × 8	530	4m	949,00
JT80-2-6	5 × 8	530	6m	1033,25
JT80-2-8	5 × 8	530	8m	1197,00
JT80-3-2	6,5 × 10	530	2m	924,75
JT80-3-4	6,5 × 10	530	4m	1014,00
JT80-3-6	6,5 × 10	530	6m	1282,50
JT80-3-8	6,5 × 10	530	8m	1424,50
JT80-4-2	8 × 12	530	2m	1085,75
JT80-4-4	8 × 12	530	4m	1282,50
JT80-4-6	8 × 12	530	6m	1558,50
JT80-4-8	8 × 12	530	8m	1919,00

JWL hulrumsslange



Med ø8mm drypfri inderlange

Varenr.	L	DKK
JT73-1	0,9m	206,75
JT73-2	1,5m	286,00
JT73-3	2,0m	319,75
JT73-4	3,0m	367,75

JWL standard malersprøjte



0,6L overkop

Varenr.	DS	DKK
JT77-1	1,4mm	2687,50
JT77-2	1,7mm	2687,50
JT77-3	2,0mm	2687,50

DS = dysestørrelse

JWL slange blød armeret PVC (POLYVINYLCHLORID)



Med JWL 520 kobling+nippel, max 15bar

Varenr.	ø × Ø	Type	L	DKK
JT81-1-5	6,3 × 11	520	5m	471,00
JT81-1-10	6,3 × 11	520	10m	610,25
JT81-1-15	6,3 × 11	520	15m	831,25
JT81-1-20	6,3 × 11	520	20m	987,50
JT81-2-5	9 × 14,5	520	5m	547,50
JT81-2-10	9 × 14,5	520	10m	751,75
JT81-2-15	9 × 14,5	520	15m	1049,75
JT81-2-20	9 × 14,5	520	20m	1237,25

JWL oliesuger til små motorer BSPP



Varenr.	BSPP	Vol.	DKK
JT74-1	1/4"	1,2L	1121,75

JWL professionel malerpistol



1L underkop

Varenr.	DS	DKK
JT78-1	2,2mm	3454,75

DS = dysestørrelse

PNEUMATISKE VIBRATORER



Vibrationsteknik løser mange problemstillinger i industrien og byggeriet.

I takt med at industriproduktionen bliver større og mere automatiseret, oplever mange virksomheder udfordringer undervejs, som hurtigt og simpelt kan løses med vibration.

- Separation, transport, komprimering og dosering af tørre materialer.
- Rensning af siloer, tragte, beholdere, sigte og filtre.
- Løsne og spredning.
- Sikre produktflow i transport kæder, rør og tragte.

Turbine vibrator

ALUMINIUM



Stor effekt, uden smøring, meget stille. Nominel frekvens 5800 ~ 46000 RMP. Vibrationskraft 135 ~ 10600N. Justerbar parameter (justere lufttryk). Kan anvendes i ekstremt dårligt miljø.

Anvendelse:

Turbine pneumatiske vibratorer forhindrer materialer i at klæbe til sien eller tragtens vægge. Særlig velegnet til fødevarer- og medicinalindustrien.

Varenr.	Dim	Model	DKK
CV1-1	1/8"	GT-04	731,50
CV1-2	1/8"	GT-06	731,50
CV1-3	1/8"	GT-08	880,75
CV1-4	1/8"	GT-10	880,75
CV1-5	1/4"	GT-13	1110,50
CV1-6	1/4"	GT-16	1110,50
CV1-7	1/4"	GT-20	1903,50
CV1-8	1/4"	GT-25	1903,50
CV1-9	3/8"	GT-30	2196,00
CV1-10	3/8"	GT-36	2196,00
CV1-11	3/8"	GT-40	3441,25
CV1-12	3/8"	GT-48	3441,25

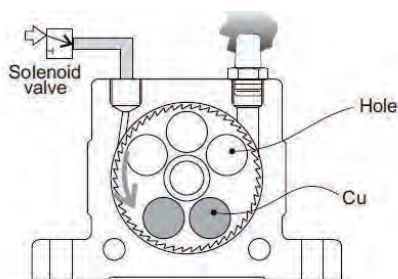

Kugle vibrator

ALUMINIUM



Stor effekt. Nominel frekvens 7300~35000 RMP. Vibrationskraft 132~4100N. Justerbar parameter (justere lufttryk).

Materiale separation, transport og komprimering, rengøring af siloer/ beholdere/ skærme og filtre. I transport kæder fremmes strømmen og problemer med blokering elimineres.

Varenr.	Dim	Model	DKK
CV2-1	1/4"	K-08	497,50
CV2-2	1/4"	K-10	497,50
CV2-3	1/4"	K-13	659,25
CV2-4	1/4"	K-16	659,25
CV2-5	1/4"	K-20	1025,00
CV2-6	1/4"	K-25	1025,00
CV2-7	3/8"	K-30	1390,50
CV2-8	3/8"	K-36	1390,50

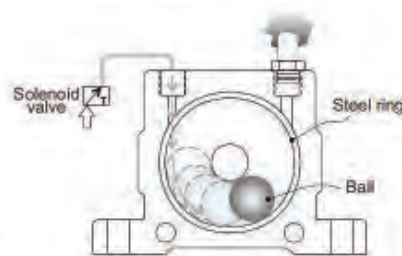

Turbine vibrator

AISI 316



Stor effekt, uden smøring, meget stille. Nominel frekvens 5800 ~ 46000 RMP. Vibrationskraft 135 ~ 10600N. Justerbar parameter (justere lufttryk). Kan anvendes i ekstremt dårligt miljø.

Anvendelse:

Turbine pneumatiske vibratorer forhindrer materialer i at klæbe til sien eller tragtens vægge. Særlig velegnet til fødevarer- og medicinalindustrien.

Varenr.	Dim	Model	DKK
CV3-1	1/8"	GT-08	3294,00
CV3-2	1/8"	GT-10	3294,00
CV3-3	1/4"	GT-13	3660,75
CV3-4	1/4"	GT-16	3660,75
CV3-5	1/4"	GT-20	4758,75
CV3-6	1/4"	GT-25	4758,75
CV3-7	3/8"	GT-30	5856,75

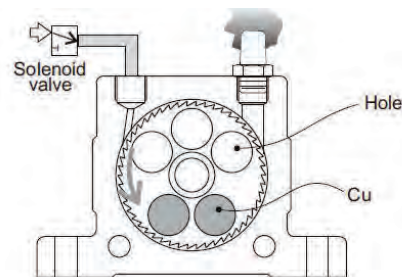

Rullelejer vibrator ALUMINUM



Stor effekt.

Nominal frekvens 10100 ~ 36100 RMP.

Vibrationskraft 1170 ~ 6150N.

Justerbar parameter (justere lufttryk).

Anvendelse:

De rullelejer pneumatiske vibratorer forbedre strømmen af produkter i tragte, beholdere og sliske samt komprimerer og adskiller.

Varenr.	Dim	Model	DKK
CV4-1	1/8"	R-50	951,75
CV4-2	1/4"	R-65	1098,00

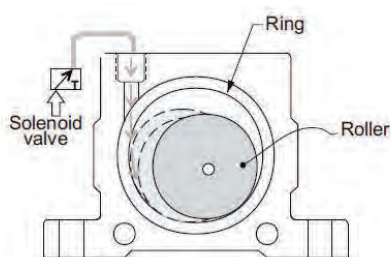

VARERNE TIL TIDEN OG OGSÅ DE RIGTIGE VARER TIL TIDEN

Vi forsøger konstant at udvikle vores leveringer og med mere end 1.600.000 fittings på lager, kræver det god orden og styr på tingene.

Vi har igennem de sidste år gjort store investinger i at køre vores lager så effektivt som muligt.

Vi har på nuværende tidspunkt alle fittings, ventiler og ... liggende inde i vores automatiske lagersystem, der rummer mere end 80.000 kasser med fittings.

Lad os hjælpe dig med få tingene til tiden, så du slipper for at bruge tid på restordre og lignende.

Hvis vi ved, hvad og hvor meget, du skal bruge, sikrer vi, at dine fittings konstant er på lager, således du ikke løber tør i din produktion eller til dit projekt.

PNEUMATIK & LUFTBEHANDLING



PRESFITTINGS



368 PRESFITTINGS
RUSTFRI AISI 316



374 PRESFITTINGS
STÅL FZ



378 PRESFITTINGS
VÆRKTØJ

PRESFITTINGS RUSTFRI AISI 316



Max 16bar



-10°C til +110°C



VA godkendt



UNI EN 10088

Rustfri AISI 316 stål presfittings til M kæber, beregnet og godkendt til drikkevandsinstallationer.

Også særdeles velegnet til industri installationer med demineraliseret eller blødgjort vand.

NB! Husk O-ring skal være af VITON, hvis denne type fittings bruges i forbindelse med olie eller smøremiddel, fx. i forbindelse med trykluft.

Press rør 6m

AISI 316



Varenr.	Ø	- -	DKK
PC1-15	15	1	666,75
PC1-18	18	1	760,00
PC1-22	22	1.2	1015,50
PC1-28	28	1.2	1229,00
PC1-35	35	1.5	1871,75
PC1-42	42	1.5	2259,00
PC1-54	54	1.5	2917,00
PC1-76	76.1	2	5693,00
PC1-88	88.9	2	6328,50
PC1-108	108	2	8126,75

Sælges kun i hele længder

Press brystnippel kort

AISI 316 / O-RING = EPDM - BSPT



Varenr.	Ø × BSPT	DKK
PC2-1512	15 × 1/2"	102,75
PC2-1534	15 × 3/4"	78,65
PC2-1812	18 × 1/2"	109,25
PC2-1834	18 × 3/4"	110,75
PC2-2212	22 × 1/2"	131,50
PC2-2234	22 × 3/4"	124,75
PC2-221	22 × 1"	136,75
PC2-2834	28 × 3/4"	170,25
PC2-281	28 × 1"	158,00
PC2-28114	28 × 1 1/4"	222,75
PC2-351	35 × 1"	216,50
PC2-35114	35 × 1 1/4"	222,75
PC2-35112	35 × 1 1/2"	269,25
PC2-42114	42 × 1 1/4"	307,25
PC2-42112	42 × 1 1/2"	324,25
PC2-54112	54 × 1 1/2"	430,50
PC2-542	54 × 2"	442,25
PC2-76212	76.1 × 2 1/2"	1735,75
PC2-883	88.9 × 3"	2586,50

Leveringstid 3-6 dage for skaffevarer

Muffe press

AISI 316 / O-RING = EPDM - BSPP



Varenr.	Ø × BSPP	DKK
PC3-1512	15 × 1/2"	128,00
PC3-1534	15 × 3/4"	135,25
PC3-1812	18 × 1/2"	136,75
PC3-1834	18 × 3/4"	135,25
PC3-2212	22 × 1/2"	126,75
PC3-2234	22 × 3/4"	191,00
PC3-221	22 × 1"	201,75
PC3-2834	28 × 3/4"	167,25
PC3-281	28 × 1"	204,25
PC3-351	35 × 1"	224,50
PC3-35114	35 × 1 1/4"	273,50
PC3-42112	42 × 1 1/2"	331,50
PC3-542	54 × 2"	425,25

Leveringstid 3-6 dage for skaffevarer

Press muffe

AISI 316 / O-RING = EPDM - BSPP



Varenr.	Ø × BSPP	DKK
PC4-1512	15 × 1/2"	188,50 ₺
PC4-28114	28 × 1 1/4"	319,50 ₺

₺ = så længe lager haves

Nippelmuffe press

AISI 316 / O-RING = EPDM



Varenr.	Ø × ø	DKK
PC5-1815	18 × 15	60,65
PC5-2215	22 × 15	65,55
PC5-2218	22 × 18	68,00
PC5-2815	28 × 15	85,70
PC5-2818	28 × 18	82,75
PC5-2822	28 × 22	84,10
PC5-3515	35 × 15	248,75
PC5-3522	35 × 22	104,75
PC5-3528	35 × 28	114,75
PC5-4222	42 × 22	231,50
PC5-4228	42 × 28	235,25
PC5-4235	42 × 35	128,50
PC5-5428	54 × 28	312,75
PC5-5435	54 × 35	274,50
PC5-5442	54 × 42	208,25
PC5-7642	76.1 × 42	647,00
PC5-7654	76.1 × 54	671,25
PC5-8854	88.9 × 54	736,75
PC5-8876	88.9 × 76.1	912,75
PC5-10854	108 × 54	851,50
PC5-10876	108 × 76.1	1075,50
PC5-10888	108 × 88.9	1191,75

Leveringstid 3-6 dage for skaffeverer

Press vinkel 90° nippel

AISI 316 / O-RING = EPDM - BSPT



Varenr.	ø × BSPT	DKK
PC6-1512	15 × 1/2"	135,25
PC6-1812	18 × 1/2"	164,50
PC6-2234	22 × 3/4"	198,25
PC6-281	28 × 1"	252,00
PC6-35114	35 × 1 1/4"	367,75
PC6-42112	42 × 1 1/2"	658,50
PC6-542	54 × 2"	830,50

Leveringstid 3-6 dage for skaffeverer

Press vinkel 90° muffe

AISI 316 / O-RING = EPDM - BSPP



Varenr.	ø × BSPP	DKK
PC7-1512	15 × 1/2"	154,00
PC7-1812	18 × 1/2"	172,75
PC7-2234	22 × 3/4"	204,75
PC7-281	28 × 1"	280,75
PC7-35114	35 × 1 1/4"	402,00

Leveringstid 3-6 dage for skaffeverer

Press bøjning 90° nip/nip

AISI 316



Varenr.	Ø	DKK
PC10-15	15	90,65
PC10-18	18	59,25
PC10-22	22	96,40
PC10-28	28	119,50
PC10-35	35	208,75
PC10-42	42	254,25
PC10-54	54	364,00

Leveringstid 3-6 dage for skaffeverer

Bøjning 90° 1D press

AISI 316 / O-RINGE = EPDM



Varenr.	ø	DKK
PC8-35	35	269,50
PC8-42	42	437,00
PC8-54	54	659,50
PC8-76,1	76.1	1147,00
PC8-88,9	88.9	2127,00
PC8-108	108	2970,75

Leveringstid 3-6 dage for skaffeverer

Bøjning 90° 1,5D press

AISI 316 / O-RINGE = EPDM



Varenr.	ø	DKK
PC9-15	15	83,55
PC9-18	18	89,60
PC9-22	22	110,00
PC9-28	28	139,50
PC9-35	35	256,00
PC9-42	42	415,50
PC9-76	76.1	1192,75
PC9-88	88.9	1491,50
PC9-108	108	2311,50

Leveringstid 3-6 dage for skaffeverer

Bøjning 45° 1D press

AISI 316 / O-RING = EPDM



Varenr.	∅	DKK
PC13-35	35	200,00 α
PC13-42	42	323,25 α
PC13-76	76.1	1192,75 α

α = så længe lager haves

Bøjning 45° 1,5D press

AISI 316 / O-RING = EPDM



Varenr.	∅	DKK
PC14-15	15	91,75
PC14-18	18	98,55
PC14-22	22	117,25
PC14-28	28	142,50
PC14-35	35	179,25
PC14-42	42	288,50
PC14-54	54	374,50
PC14-76	76.1	1178,50
PC14-88	88.9	1440,00
PC14-108	108	1964,25

Leveringstid 3-6 dage for skaffevarer

Press bøjning 90° 1D

AISI 316 / O-RING = EPDM



Varenr.	∅ × ∅	DKK
PC18-35	35	237,25
PC18-42	42	383,75
PC18-54	54	552,50
PC18-76	76.1	1173,25
PC18-88	88.9	2138,50
PC18-108	108	2889,25

Leveringstid 3-6 dage for skaffevarer

Press bøjning 90° 1,5D

AISI 316 / O-RING = EPDM



Varenr.	∅ × ∅	DKK
PC19-15	15	72,90
PC19-18	18	84,40
PC19-22	22	99,95
PC19-28	28	124,25
PC19-35	35	193,00
PC19-42	42	336,25
PC19-54	54	469,75
PC19-76	76.1	1211,50
PC19-88	88.9	1421,50
PC19-108	108	1944,75

Leveringstid 3-6 dage for skaffevarer

Press bøjning 45° 1,5D

AISI 316 / O-RING = EPDM



Varenr.	∅ × ∅	DKK
PC23-15	15	86,05
PC23-18	18	95,80
PC23-22	22	104,50
PC23-28	28	142,25
PC23-35	35	169,25
PC23-42	42	273,00
PC23-54	54	356,25
PC23-76	76.1	1177,50
PC23-88	88.9	1441,00
PC23-108	108	1964,25

Leveringstid 3-6 dage for skaffevarer

Press bøjning 60° 1D

AISI 316 / O-RING = EPDM



Varenr.	∅ × ∅	DKK
PC20-35	35	225,75 α
PC20-42	42	360,50 α
PC20-54	54	473,00 α
PC20-76	76.1	1139,00
PC20-88	88.9	1913,00
PC20-108	108	2514,00

α = så længe lager haves

Press bøjning 60° 1,5D

AISI 316 / O-RING = EPDM



Varenr.	∅ × ∅	DKK
PC21-15	15	100,25 α

α = så længe lager haves

T-stk press

AISI 316 / O-RINGE = EPDM



Varenr.	ø	DKK
PC27-15	15	127,00
PC27-18	18	131,50
PC27-22	22	141,25
PC27-28	28	172,75
PC27-35	35	243,50
PC27-42	42	314,50
PC27-54	54	393,75
PC27-76	76.1	1866,50
PC27-88	88.9	2128,00
PC27-108	108	2639,00

Leveringstid 3-6 dage for skaffeverer

T-stk press/muf gren

AISI 316 / O-RINGE = EPDM - BSPP



Varenr.	ø × BSPP × ø	DKK
PC29-1512	15 × 1/2" × 15	152,50
PC29-1812	18 × 1/2" × 18	154,50
PC29-2212	22 × 1/2" × 22	159,00
PC29-2234	22 × 3/4" × 22	173,25
PC29-2812	28 × 1/2" × 28	185,00
PC29-2834	28 × 3/4" × 28	224,00
PC29-3512	35 × 1/2" × 35	224,50
PC29-3534	35 × 3/4" × 35	246,00
PC29-4212	42 × 1/2" × 42	280,75
PC29-4234	42 × 3/4" × 42	322,75
PC29-5412	54 × 1/2" × 54	326,75
PC29-5434	54 × 3/4" × 54	376,25
PC29-542	54 × 2" × 54	604,50
PC29-7634	76.1 × 3/4" × 76.1	1702,75
PC29-762	76.1 × 2" × 76.1	1899,50
PC29-8834	88.9 × 3/4" × 88.9	1866,50
PC29-882	88.9 × 2" × 88.9	2128,00
PC29-10834	108 × 3/4" × 108	2389,75
PC29-1082	108 × 2" × 108	2410,25

Leveringstid 3-6 dage for skaffeverer

T-stk press reduktion

AISI 316 / O-RINGE = EPDM



Varenr.	ø	DKK
PC28-1815	18 × 15 × 18	144,00
PC28-2215	22 × 15 × 22	147,25
PC28-2218	22 × 18 × 22	149,00
PC28-2815	28 × 15 × 28	150,75
PC28-2818	28 × 18 × 28	158,00
PC28-2822	28 × 22 × 28	167,25
PC28-3515	35 × 15 × 35	203,00
PC28-3518	35 × 18 × 35	204,75
PC28-3522	35 × 22 × 35	206,50
PC28-3528	35 × 28 × 35	209,75
PC28-4222	42 × 22 × 42	297,75
PC28-4228	42 × 28 × 42	301,25
PC28-4235	42 × 35 × 42	307,75
PC28-5422	54 × 22 × 54	333,50
PC28-5428	54 × 28 × 54	337,00
PC28-5435	54 × 35 × 54	343,75
PC28-5442	54 × 42 × 54	350,25
PC28-7622	76.1 × 22 × 76.1	1603,75
PC28-7628	76.1 × 28 × 76.1	1636,75
PC28-7635	76.1 × 35 × 76.1	1751,00
PC28-7642	76.1 × 42 × 76.1	1915,00
PC28-7654	76.1 × 54 × 76.1	2045,75
PC28-8835	88.9 × 35 × 88.9	1934,25

Leveringstid 3-6 dage for skaffeverer

Muffe press

AISI 316 / O-RINGE = EPDM



Varenr.	ø	DKK
PC30-15	15	49,65
PC30-18	18	55,45
PC30-22	22	63,35
PC30-28	28	76,45
PC30-35	35	94,20
PC30-42	42	127,00
PC30-54	54	165,50
PC30-76	76.1	720,00
PC30-88	88.9	915,25
PC30-108	108	1179,50

Leveringstid 3-6 dage for skaffeverer

Skydemuffe press

AISI 316 / O-RINGE = EPDM



Varenr.	ø	DKK
PC31-15	15	85,20
PC31-18	18	88,45
PC31-22	22	99,70
PC31-28	28	121,25
PC31-35	35	154,00
PC31-42	42	168,75
PC31-54	54	231,00
PC31-76	76.1	1211,50
PC31-88	88.9	1368,00
PC31-108	108	1642,00

Leveringstid 3-6 dage for skaffeverer

Union press/muffe

AISI 316 / O-RING = EPDM - BSPP



Varenr.	∅ × BSPP	DKK
PC32-1512	15 × 1/2"	252,75
PC32-1812	18 × 1/2"	269,50
PC32-2234	22 × 3/4"	369,50
PC32-221	22 × 1"	437,00
PC32-281	28 × 1"	474,00
PC32-35114	35 × 1 1/4"	621,75
PC32-42112	42 × 1 1/2"	878,50
PC32-542	54 × 2"	958,50

Leveringstid 3-6 dage for skaffevarer

Press slutmuffe

AISI 316 / O-RING = EPDM



Varenr.	∅	DKK
PC38-15	15	86,80
PC38-18	18	89,00
PC38-22	22	96,10
PC38-28	28	124,75
PC38-35	35	141,25
PC38-42	42	196,25
PC38-54	54	262,25
PC38-76	76.1	540,50
PC38-88	88.9	708,25
PC38-108	108	873,00

Leveringstid 3-6 dage for skaffevarer

Press O-ring/pakning

EPDM



Varenr.	∅	DKK
PC80-12	12	6,05
PC80-15	15	5,95
PC80-18	18	6,35
PC80-22	22	6,35
PC80-28	28	7,30
PC80-35	35	10,85
PC80-42	42	11,55
PC80-54	54	13,55
PC80-76	76.1	24,95
PC80-88	88.9	30,10
PC80-108	108	56,50

Leveringstid 3-6 dage for skaffevarer

Union press/nippel

AISI 316 / O-RING = EPDM - BSPT



Varenr.	∅ × BSPT	DKK
PC35-1512	15 × 1/2"	276,50
PC35-1812	18 × 1/2"	279,50
PC35-2234	22 × 3/4"	334,75
PC35-281	28 × 1"	469,25
PC35-35114	35 × 1 1/4"	596,50
PC35-42112	42 × 1 1/2"	855,75
PC35-542	54 × 2"	1032,25

Leveringstid 3-6 dage for skaffevarer

Kompensator press

AISI 316 / O-RINGE = EPDM



Varenr.	∅	DKK
PC71-22	22	3190,00
PC71-28	28	3628,75
PC71-35	35	4357,00
PC71-42	42	4946,25
PC71-54	54	6234,75
PC71-76	76.1	9290,75
PC71-88	88.9	11567,00
PC71-108	108	14095,75

Leveringstid 3-6 dage for skaffevarer

Press O-ring/pakning

VITON



Varenr.	∅	DKK
PC81-15	15	9,20
PC81-18	18	10,65
PC81-22	22	11,75
PC81-28	28	13,65
PC81-35	35	17,15
PC81-42	42	22,40
PC81-54	54	25,95
PC81-76	76.1	51,70
PC81-88	88.9	77,00
PC81-108	108	141,75

Press overbøjning

AISI 316



Varenr.	∅	DKK
PC37-15	15	142,25
PC37-18	18	161,00
PC37-22	22	189,50
PC37-28	28	230,00

Leveringstid 3-6 dage for skaffevarer

Rørholder med skrue

AISI 304



Varenr.	Ø	DKK
BR700-12	12	9,00
BR700-15	15	11,40
BR700-18	18	13,30
BR700-22	22	17,55
BR700-28	28	28,15

Rørholder med skrue

AISI 304



Varenr.	Ø	DKK
BR701-12	12	42,50
BR701-15	15	36,20
BR701-18	18	40,55
BR701-22	22	51,25

Rørholder med sokkel

AISI 304



M5 gevind i sokkel

Varenr.	Ø	DKK
BR702-15	15	21,85
BR702-18	18	24,85
BR702-22	22	29,50
BR702-28	28	40,85

PRESFITTINGS STÅL FZ



Max 16bar



-10°C til +110°C



Stål presfittings beregnet til M kæber. Særlig velegnet til industri installationer.

Presfittings leveres som standard med EPDM O-ring

NB! Husk O-ring skal være af NBR, hvis denne type fittings bruges i forbindelse med olie eller smøremiddel, fx. i forbindelse med trykluft.

Press rør 6m STÅL FZ

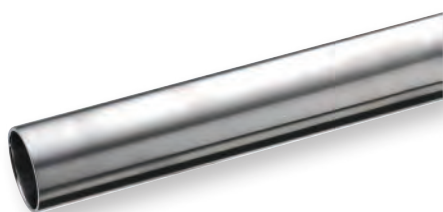

Varenr.	Ø	- -	DKK
PG1-12	12	1,2	327,75
PG1-15	15	1,2	262,75
PG1-18	18	1,2	318,50
PG1-22	22	1,5	426,50
PG1-28	28	1,5	552,25
PG1-35	35	1,5	693,25
PG1-42	42	1,5	823,00
PG1-54	54	1,5	1067,25

Leveringstid 3-6 dage for skaffevarer

Press brystnippel kort STÅL FZ/EPDM - BSPT



Varenr.	Ø × BSPP	DKK
PG2-1238	12 × 3/8"	52,95
PG2-1538	15 × 3/8"	51,00
PG2-1512	15 × 1/2"	51,65
PG2-1812	18 × 1/2"	55,70
PG2-2212	22 × 1/2"	72,90
PG2-1534	15 × 3/4"	72,90
PG2-1834	18 × 3/4"	72,90
PG2-2234	22 × 3/4"	64,45
PG2-2834	28 × 3/4"	100,50
PG2-221	22 × 1"	100,50
PG2-281	28 × 1"	83,30
PG2-351	35 × 1"	133,50
PG2-35114	35 × 1 1/4"	126,50
PG2-42114	42 × 1 1/4"	176,50
PG2-42112	42 × 1 1/2"	158,50
PG2-542	54 × 2"	237,25
PG2-76212	76.1 × 2 1/2"	806,00
PG2-883	88.9 × 3"	1108,50

Leveringstid 3-6 dage for skaffevarer

Press muffe kort STÅL FZ/EPDM - BSPP



Varenr.	Ø × BSPP	DKK
PG3-1212	12 × 1/2"	57,10
PG3-1512	15 × 1/2"	54,05
PG3-1812	18 × 1/2"	61,45
PG3-2212	22 × 1/2"	66,10
PG3-1834	18 × 3/4"	62,80
PG3-2234	22 × 3/4"	66,10
PG3-221	22 × 1"	106,00
PG3-281	28 × 1"	83,30
PG3-35114	35 × 1 1/4"	126,50
PG3-42112	42 × 1 1/2"	208,75
PG3-542	54 × 2"	311,50

Leveringstid 3-6 dage for skaffevarer

Press muffe lang
STÅL FZ/EPDM - BSPP



Varenr.	ø × BSPP	DKK
PG4-1512	15 × 1/2"	83,30
PG4-1812	18 × 1/2"	86,25
PG4-1534	15 × 3/4"	86,55
PG4-1834	18 × 3/4"	88,45
PG4-2234	22 × 3/4"	106,00
PG4-221	22 × 1"	106,00
PG4-281	28 × 1"	138,00
PG4-28114	28 × 1 1/4"	138,00
PG4-35114	35 × 1 1/4"	194,50
PG4-35112	35 × 1 1/2"	194,50
PG4-42112	42 × 1 1/2"	278,00
PG4-42134	42 × 1 3/4"	278,00
PG4-542	54 × 2"	356,75
PG4-54238	54 × 2 3/8"	356,75
PG4-76212	76.1 × 2 1/2"	717,00

Leveringstid 3-6 dage for skaffevarer

Vinkel 90° press/nippel
STÅL FZ/EPDM - BSPP



Varenr.	ø × BSPT	DKK
PG6-1812	18 × 1/2"	64,70
PG6-2234	22 × 3/4"	93,40

Leveringstid 3-6 dage for skaffevarer

Vinkel 90° press/muffe
STÅL FZ/EPDM - BSPP



Varenr.	ø × BSPP	DKK
PG7-1512	15 × 1/2"	84,65
PG7-1812	18 × 1/2"	91,75
PG7-2234	22 × 3/4"	109,25
PG7-2812	28 × 1"	141,25

Leveringstid 3-6 dage for skaffevarer

Press bøjning 90° 1,5D
STÅL FZ/EPDM



Varenr.	ø	DKK
PG9-12	12	28,95
PG9-15	15	27,65
PG9-18	18	35,05
PG9-22	22	38,35
PG9-28	28	50,75
PG9-35	35	123,75
PG9-42	42	188,50
PG9-54	54	239,00
PG9-76	76.1	683,25
PG9-88	88.9	1013,75
PG9-108	108	1290,75

Leveringstid 3-6 dage for skaffevarer

Press bøjning 90° 1D muf/nip
STÅL FZ/EPDM



Varenr.	ø	DKK
PG18-12	12	28,70
PG18-15	15	28,95
PG18-18	18	34,50
PG18-22	22	37,00
PG18-28	28	48,85
PG18-35	35	123,75
PG18-42	42	189,50
PG18-54	54	239,00
PG18-76	76.1	611,00
PG18-88	88.9	1041,50
PG18-108	108	1360,75

Leveringstid 3-6 dage for skaffevarer

Bøjning 90° press/muffe
STÅL FZ/EPDM



Varenr.	ø × BSPP	DKK
PG43-1512	15 × 1/2"	84,65
PG43-1812	18 × 1/2"	91,75
PG43-2234	18 × 3/4"	109,25
PG43-281	22 × 1"	141,25

Leveringstid 3-6 dage for skaffevarer

Press bøjning 90° nip/nip
STÅL FZ



Varenr.	ø	DKK
PG10-12	12	25,65
PG10-15	15	27,05
PG10-18	18	27,90
PG10-22	22	27,65
PG10-28	28	37,85
PG10-35	35	97,20
PG10-42	42	153,00
PG10-54	54	194,25

Leveringstid 3-6 dage for skaffevarer

Press bøjning 45° 1D STÅL FZ/EPDM



Varenr.	ø	DKK
PG13-12	12	32,30
PG13-15	15	33,10
PG13-18	18	34,50
PG13-22	22	37,00
PG13-28	28	50,20
PG13-35	35	121,00
PG13-42	42	145,50
PG13-54	54	188,50
PG13-76	76.1	673,25
PG13-88	88.9	971,75
PG13-108	108	1249,50

Leveringstid 3-6 dage for skaffevarer

T-stk press STÅL FZ/EPDM



Varenr.	ø	DKK
PG27-12	12	56,50
PG27-15	15	56,85
PG27-18	18	60,05
PG27-22	22	67,75
PG27-28	28	83,30
PG27-35	35	135,75
PG27-42	42	194,25
PG27-54	54	239,00
PG27-76	76.1	1462,75
PG27-88	88.9	1677,00
PG27-108	108	1958,25

Leveringstid 3-6 dage for skaffevarer

T-stk press reduktion STÅL FZ/EPDM



Varenr.	ø	DKK
PG28-1512	15 × 12 × 15	54,05
PG28-1812	18 × 12 × 18	58,45
PG28-1815	18 × 15 × 18	57,90
PG28-2212	22 × 12 × 22	62,55
PG28-2215	22 × 15 × 22	61,45
PG28-2218	22 × 18 × 22	63,35
PG28-2815	28 × 15 × 28	78,10
PG28-2818	28 × 18 × 28	78,65
PG28-2822	28 × 22 × 28	80,85
PG28-3515	35 × 15 × 35	121,50
PG28-3518	35 × 18 × 35	127,50
PG28-3522	35 × 22 × 35	132,00
PG28-3528	35 × 28 × 35	133,50
PG28-4222	42 × 22 × 42	175,50
PG28-4228	42 × 28 × 42	179,25
PG28-4235	42 × 35 × 42	183,25
PG28-5422	54 × 22 × 54	207,00
PG28-5428	54 × 28 × 54	211,00
PG28-5435	54 × 35 × 54	218,00
PG28-5442	54 × 42 × 54	228,25
PG28-7654	76.1 × 54 × 76.1	1205,25
PG28-8876	88.9 × 76 × 88.9	1585,25
PG28-10888	108 × 88 × 108	1882,00

Leveringstid 3-6 dage for skaffevarer

Press bøjning 45° 1D muf/nip STÅL FZ/EPDM



Varenr.	ø	DKK
PG22-12	12	32,55
PG22-15	15	32,55
PG22-18	18	33,65
PG22-22	22	36,45
PG22-28	28	48,85
PG22-35	35	120,00
PG22-42	42	145,50
PG22-54	54	188,50
PG22-76	76.1	638,50
PG22-88	88.9	971,75
PG22-108	108	1249,50

Leveringstid 3-6 dage for skaffevarer

Press T-stk med muffe STÅL FZ/EPDM - BSPP



Varenr.	ø × BSPP × ø	DKK
PG29-1512	15 × 1/2" × 15	74,55
PG29-1812	18 × 1/2" × 18	77,25
PG29-2212	22 × 1/2" × 22	78,35
PG29-1834	18 × 3/4" × 18	67,45
PG29-2234	22 × 3/4" × 22	96,65
PG29-2812	28 × 1/2" × 28	86,05
PG29-2834	28 × 3/4" × 28	107,25
PG29-3512	35 × 1/2" × 35	134,75
PG29-3534	35 × 3/4" × 35	155,75
PG29-4212	42 × 1/2" × 42	203,00
PG29-4234	42 × 3/4" × 42	236,25
PG29-5412	54 × 1/2" × 54	242,75
PG29-5434	54 × 3/4" × 54	254,25
PG29-7634	76.1 × 3/4" × 76.1	1465,75
PG29-8834	88.9 × 3/4" × 88.9	1626,50
PG29-10834	108 × 3/4" × 108	1988,00

Leveringstid 3-6 dage for skaffevarer

Press muffe

STÅL FZ/EPDM



Varenr.	ø	DKK
PG30-12	12	19,35
PG30-15	15	19,90
PG30-18	18	21,25
PG30-22	22	24,10
PG30-28	28	28,40
PG30-35	35	49,95
PG30-42	42	66,10
PG30-54	54	85,20
PG30-76	76.1	406,50
PG30-88	88.9	504,50
PG30-108	108	655,25

Leveringstid 3-6 dage for skaffevarer

Press O-ring/pakning

EPDM



Varenr.	ø	DKK
PC80-12	12	6,05
PC80-15	15	5,95
PC80-18	18	6,35
PC80-22	22	6,35
PC80-28	28	7,30
PC80-35	35	10,85
PC80-42	42	11,55
PC80-54	54	13,55
PC80-76	76.1	24,95
PC80-88	88.9	30,10
PC80-108	108	56,50

Leveringstid 3-6 dage for skaffevarer

Press skydemuffe

STÅL FZ/EPDM



Varenr.	ø	DKK
PG31-12	12	25,65
PG31-15	15	27,30
PG31-18	18	34,75
PG31-22	22	35,85
PG31-28	28	46,65
PG31-35	35	81,10
PG31-42	42	97,20
PG31-54	54	113,75
PG31-76	76.1	590,00
PG31-88	88.9	739,00
PG31-108	108	906,00

Leveringstid 3-6 dage for skaffevarer

PRESFITTINGS VÆRKTØJ



Værktøj til at sikre korrekt montering af presfittings.

UDGÅET

PUMPER, TANKE- & BEHOLDERE TILBHØR



380 PUMPER & LIGN.



385 TANKE- & BEHOLDERE
TILBEHØR

PUMPER & LIGN.



Pumper til almindelige industrielle behov.



Pumpe til olie

STØBEJERN / PAKNING = NBR

Varenr.	dim	Vol.	DKK
R2-0	2"	0,35ltr.	678,75



Pumpe til div. væsker

PP (POLYPROPYLEN) / PTFE (TEFLON)

Varenr.	dim	Vol.	DKK
R2-1	2"	0,35ltr.	1260,75



Pumpe til fødevarer

AISI 304 / PAKNING = PTFE (TEFLON) + NBR

Varenr.	dim	Vol.	DKK
R2-2	2"	0,35ltr.	2166,25

Fedtpresser m. pumpegang



Varenr.	Str.	DKK
K33-1	-	650,00

Fedtpresser enhånds



Varenr.	Str.	DKK
K34-1	-	829,75

Fedtpresser elektrisk



Varenr.	Batterier	DKK
K35-1	1	5472,50
K35-2	2	6727,00

Smøreslange



Varenr.	Str.	DKK
K36-1	12-300	195,00
K36-2	18-500	277,75
K36-3	24-600	286,50

Hydraulisk smørehoved



Varenr.	BSPP	DKK
K37-1	1/8"	108,00

Smørenippel sortiment



Varenr.	Antal	DKK
K38-1	120	1949,00

Beholderpumpe AISI 316 / PTFE (TEFLON)



Flow: 235ml pr. træk. Max temp: +60°C.
Max viskositet: 5000 SSU. Brugbar til syre, methylenclorid og andre aggressive medier, samt olie, benzin mm.

Varenr.	dim	Vol.	DKK
R1-1	2"	0,25ltr.	735,25

Beholderpumpe

PP (POLYPROPYLEN) / PAKNING = NBR



Flow: 235ml pr. træk. Max temp: +60°C. Max viskositet: 4000 SSU. Brugbar til vandbase-rede væsker.

Varenr.	ø indv.	Vol.	DKK
R3-1	51	0,25ltr.	163,50

Sugepumpe

PE (POLYETHYLEN)



Flow: 7,5 LPM. Max temp: +60°C. Max viskositet: 500 SSU. Brugbar til petroleum, lette olier, benzin etc.

Varenr.	Str.	DKK
R4-1	-	50,60

Sugepumpe

PE (POLYETHYLEN)



Flow: 19 LPM. Max temp: +60°C. Max viskositet: 500 SSU. Brugbar til petroleum, lette olier, benzin etc.

Varenr.	dim	DKK
R4-3	2"	153,75

Sugepumpe

PE (POLYETHYLEN)

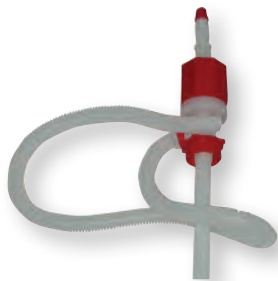

Flow: 26,5 LPM. Max temp: +60°C. Max viskositet: 500 SSU. Brugbar til petroleum, lette olier, benzin etc.

Varenr.	dim	DKK
R4-4	2"	153,75

Mini sugepumpe

PE (POLYETHYLEN)



Letvægtstype, bærbar, økonomisk.

Varenr.	Str.	DKK
R4-2	-	37,25

Sugepumpe

PU (POLYURETHAN) / PP (POLYPROPYLEN)

Handy pumpetype til forefaldende pumpearbejde.



Handy pumpetype til forefaldende pumpearbejde.

Varenr.	Str.	DKK
R4-5	-	131,75

Oliekande



Varenr.	Str.	DKK
K21-1	0,4L	298,50

Oliekande



Varenr.	Str.	DKK
K21-2	0,4L	405,00

Oliekande



Varenr.	Str.	DKK
K21-3	0,4L	587,75

Penselkande



Varenr.	Str.	DKK
K21-4	0,4L	714,75

Olieflaske m. messingspids



Varenr.	Str.	DKK
K22-1	0,3L	69,35

Oliemål



Varenr.	Str.	DKK
K29-1	1L	174,25
K29-2	2L	236,50
K29-3	5L	397,25

Tragtsæt



Varenr.	Str.	DKK
K31-1	ø50/75/100/120	62,00

Tragt



Varenr.	Str.	DKK
K31-2	ø150/ø16	44,40

Tragt



Varenr.	Str.	DKK
K31-3	ø200/ø22	171,50

Dieselpumpesæt 230V



Varenr.	Str.	DKK
K32-1	-	6780,50

Forstøver



KABI Chemo sprayhoved med justerbar dyse. Benyttes til mange aggressive væsker, da sprayhovedet er produceret af kemikalie resistente materialer.

Varenr.	Str.	DKK
K19-1	0,65L	251,25

Tragt



Varenr.	Str.	DKK
K31-4	ø250/ø24	277,75

Tragt



Varenr.	Str.	DKK
K31-5	ø220/ø22	207,00

Tragt



Varenr.	Str.	DKK
K31-6	ø200/ø22	511,25

Tryksprayer 1,0 ltr.

PA - PAKNING VITON



KABI Chemo tryk-sprayer 1,0 ltr. Velegnet til forstøvning af aggressive væsker, dog ikke sprit- og acetoneholdige produkter. Specielt velegnet til til oliebaseerede væsker. Man skal dog altid sikre sig at sprayeren ikke beskadiges af det anvendte produkt. Er forsynet med justerbar dyse. Arbejdstryk: 3 bar

Varenr.	Str.	DKK
K20-1	1L	983,50

Målebæger



Varenr.	Str.	DKK
K30-1	2L	114,00
K30-2	5L	161,00

Trykprøvningspumpe PLAST



Varenr.	Vægt	BAR	DKK
R5-2	4,6Kg	0 - 25	1206,25

Trykprøvningspumpe STÅL

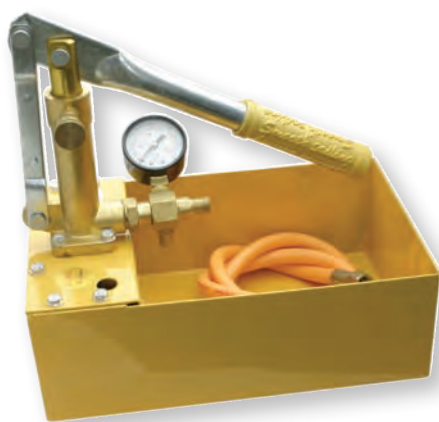

Varenr.	Vægt	BAR	DKK
R5-5	5,5Kg	0 - 25	1467,75

Trykprøvningspumpe PLAST



Varenr.	Vægt	BAR	DKK
R5-4	5,5Kg	0 - 60	1350,50

Trykprøvningspumpe STÅL



Varenr.	Vægt	BAR	DKK
R5-7	5,5Kg	0 - 60	1552,25

TANKE- OG BEHOLDERE TILBEHØR



Dette afsnit omfatter tilbehør til tanke, tønder og beholdere.

Især til sidst i afsnittet er der nogle deciderede livreddere, hvis man står og mangler dem:

TØNDEADAPTERE.

Disse plastikadaptere bruges, hvor tønder, tromler og IBC'ere med ikke-standard gevind skal konverteres til 2" BSP gevind, så man kan bruge standardpumper og -haner.

At finde den rigtige adapter kan være rigtig svært, da der typisk ikke er nogen informationer på den aktuelle beholder om gevindet. Men bemærk at farven på adapteren ikke er tilfældigt valgt og kan hjælpe til at sikre, at man får den rigtige

Afløbsstuds PE (POLYETHYLEN)

Studs m. minihane PE (POLYETHYLEN)

Ventil 'butterfly' PE (POLYETHYLEN)



Med 'Gardena' tilslutning

Varenr.	dim	DKK
R24-1	2" α	252,75

α = tøndegevind

Afløbsstuds PE (POLYETHYLEN)

Spidsmuffe PP (POLYPROPYLEN)

Kugleventil PE (POLYETHYLEN)



Varenr.	dim	DKK
R25-1	3" x 2" α	303,00

α = tøndegevind

Slangestuds PE (POLYETHYLEN)

Afløbsstuds PE (POLYETHYLEN)



Varenr.	dim	DKK
R23-1	Ø12 ~ 1/2" x 2" α	252,75
R23-2	Ø19 ~ 3/4" x 2" α	252,75

α = tøndegevind

UDGÅET

UDGÅET

UDGÅET

UDGÅET

UDGÅET

Aftapningshane PP (POLYPROPYLEN)



Varenr.	Str.	DKK
K25-1	DIN51	69,35
K25-2	DIN61	69,35

Adapter AD/M PP (POLYPROPYLEN)



Bruges til plastiktromler med MAUSER gevind M70*6, f.eks. fra Mauser, Rexam Harcostar, Wiva, Gallay, Dynoplast, Roug, Ostenjo.

M70 = nippel, 2" = muffe

Varenr.	dim	DKK
R6-1	M70*6 x 2" BSPP	200,00

Adapter AD/USIBC PP (POLYPROPYLEN)



Bruges til amerikanske IBC'ere, f.eks. fra Hoover, Sonoco.

DIN61 = nippel, 2" = muffe

Varenr.	dim	DKK
R6-3	DIN61 x 2" BSPP	127,00

UV tankcover til R20-1/IBC

UDGÅET

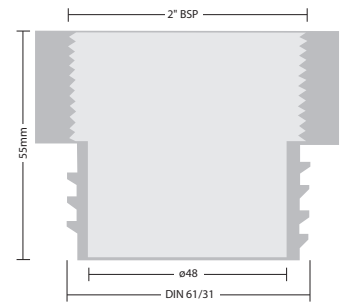
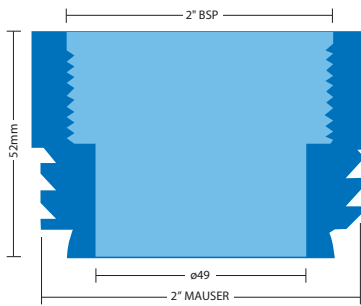

Adapter AD/TS PP (POLYPROPYLEN)



Bruges til tønder med TriSure gevind M56*4, f.eks. fra Van Leer, Economic Drums, Gem Plastics, Dynoplast, Rexam Harcostar, Roug, Hannelis, Sotralentz, Schutz.

M56 = nippel, 2" = muffe

Varenr.	dim	DKK
R6-2	M56*4 x 2" BSPP	127,00

Adapter AD/DIN51 PP (POLYPROPYLEN)



DIN51 = nippel, 2" = muffe

Varenr.	dim	DKK
R6-4	DIN51 x 2" BSPP	200,00

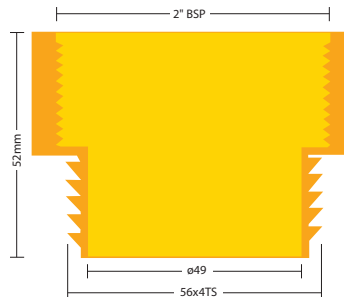

Adapter AD/DIN61

PP (POLYPROPYLEN)



Bruges til tønder/IBC'ere med DIN61 gevind, f.eks. fra Van Leer (Valerex), Economic Drums, Gallay, Mauser, Schutz Drums & IBC's, Sotralentz IBC's, Van Leer Unicubes.

Muffe i begge ender

Varenr.	dim	DKK
R6-5	DIN61 × 2" BSPP	200,00

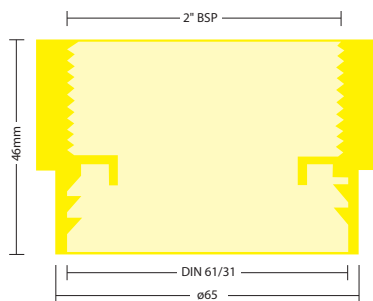

Adapter AD/DIN71

PP (POLYPROPYLEN)



Bruges til L-ring tønder fra Tyskland med stor åbning, f.eks. fra Mauser og andre tyske producenter.

Muffe i begge ender

Varenr.	dim	DKK
R6-7	DIN71 × 2" BSPP	200,00

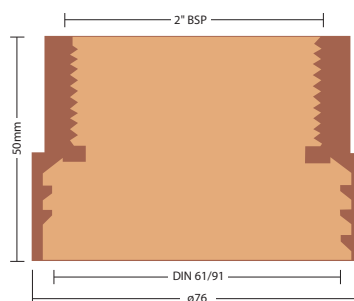

Adapter AD/DIN2XM

PP (POLYPROPYLEN)



Bruges til nogle amerikanske IBC'ere, f.eks. fra Schutz og Finncont.

Nippel i begge ender

Varenr.	dim	DKK
R6-9	DIN61 × 2" BSPP	294,75

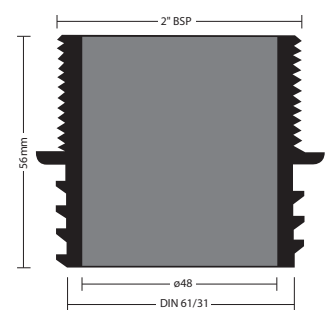

Adapter AD/63mm

PP (POLYPROPYLEN)



Muffe i begge ender

Varenr.	dim	DKK
R6-6	DIN63 × 2" BSPP	200,00

Mauser prop

PP (POLYPROPYLEN)



Med ekstra 3/4" prop

Varenr.	dim	DKK
R6-10	MAUSER M70*6	145,75

TriSure prop

PP (POLYPROPYLEN)



Med ekstra 3/4" prop

Varenr.	dim	DKK
R6-11	TRISURE M56*4	145,75

Adapter AD/M-TS

PP (POLYPROPYLEN)



Mauser M70 muffe, TriSure M56 nippel

Varenr.	dim	DKK
R6-8	M70*6 × M56*4	410,75

HJÆLP OS MED AT UDVIKLE ROYKON A/S

Vi har brug for din hjælp til at udvikle os i den rigtige retning.

Hvis du har ideer til nye produkter eller du kender en, der kan bruge vores produkter, så vent ikke med at henvende dig til os.

Vi elsker nye udfordringer med hensyn til nye produkter og hvis du kunne tænke dig, at vi havde et bestemt produkt i vores program, så skriv eller ring til os.

Vi sender også gerne vores katalog til en person, som du mener burde have det. Du er selvfølgelig også velkommen til at rekvirere flere kataloger til jeres virksomhed, hellere et for meget end et for lidt.

PUMPER, TANKE- & BEHOLDERE TILBEHØR



RUSTFRI FITTINGS



390 GEVINDFITTINGS
RUSTFRI AISI 316



402 GEVINDFITTINGS
RUSTFRI AISI 316 LIGHT



405 MUFFER & NIPPELRØR
RUSTFRI AISI 316



408 NPT FITTINGS
RUSTFRI AISI 316



411 FLANGER
RUSTFRI/ALU



417 FLANGER PVC



419 REPARATIONSMUFFER
RUSTFRI AISI 316



420 SKÆRERINGSFITTINGS
RUSTFRI AISI 316



436 GEVINDFITTINGS
RS. AISI 316 HØJTRYK



442 KLEMRINGSFITTINGS
AIS I 316 TIL METRISKE RØR



449 KLEMRINGSFITTINGS
AIS I 316 TIL TOMME RØR



454 PUSH-IN FITTINGS
RUSTFRI AISI 316



459 PUSH-ON FITTINGS
RUSTFRI AISI 316

GEVINDFITTINGS RUSTFRI AISI 316



Normalt max 10bar



-20°C til +400°C



Komplet program af rustfri syrefast rørgvind fittings, voksstøbt med glatte overflader.

Leveres som standard med BSP gevind, men bemærk, vi har et afsnit med NPT gevind.



RUSTFRI FITTINGS

Vinkel 90° muf/muf
AISI 316 - BSPP



Varenr.	BSPP	DKK
B1-1	1/8"	32,10
B1-2	1/4"	33,25
B1-3	3/8"	36,35
B1-4	1/2"	50,10
B1-5	3/4"	81,65
B1-6	1"	126,75
B1-7	1 1/4"	178,00
B1-8	1 1/2"	208,00
B1-9	2"	327,75
B1-10	2 1/2"	736,25
B1-11	3"	1065,25
B1-12	4"	1807,75

Vinkel 90° red. muf/muf
AISI 316 - BSPP



Varenr.	BSPP	DKK
B1-2-1	1/4" x 1/8"	43,10
B1-3-2	3/8" x 1/4"	68,25
B1-4-3	1/2" x 3/8"	71,55
B1-5-2	3/4" x 1/4"	98,55
B1-5-3	3/4" x 3/8"	98,55
B1-5-4	3/4" x 1/2"	98,55
B1-6-4	1" x 1/2"	155,25
B1-6-5	1" x 3/4"	155,25
B1-7-5	1 1/4" x 3/4"	206,00
B1-7-6	1 1/4" x 1"	206,00
B1-8-6	1 1/2" x 1"	299,50
B1-8-7	1 1/2" x 1 1/4"	299,50
B1-9-8	2" x 1 1/2"	457,75

T-stk m. muffer
AISI 316 - BSPP



Varenr.	BSPP	DKK
B2-1	1/8"	39,35
B2-2	1/4"	41,10
B2-3	3/8"	53,20
B2-4	1/2"	74,55
B2-5	3/4"	113,50
B2-6	1"	155,25
B2-7	1 1/4"	231,00
B2-8	1 1/2"	282,00
B2-9	2"	424,75
B2-10	2 1/2"	1011,50
B2-11	3"	1250,50
B2-12	4"	2367,00

T-stk m. muffe red.

AISI 316 - BSPP



Varenr.	BSPP	DKK
B2-2-1	1/4" x 1/8" x 1/4"	46,20
B2-3-2	3/8" x 1/4" x 3/8"	62,30
B2-4-1	1/2" x 1/8" x 1/2"	80,25
B2-4-2	1/2" x 1/4" x 1/2"	80,25
B2-4-3	1/2" x 3/8" x 1/2"	80,25
B2-5-2	3/4" x 1/4" x 3/4"	128,00
B2-5-3	3/4" x 3/8" x 3/4"	128,00
B2-5-4	3/4" x 1/2" x 3/4"	128,00
B2-6-2	1" x 1/4" x 1"	186,25
B2-6-3	1" x 3/8" x 1"	186,25
B2-6-4	1" x 1/2" x 1"	186,25
B2-6-5	1" x 3/4" x 1"	186,25
B2-7-3	1 1/4" x 3/8" x 1 1/4"	241,00
B2-7-4	1 1/4" x 1/2" x 1 1/4"	241,00
B2-7-5	1 1/4" x 3/4" x 1 1/4"	241,00
B2-7-6	1 1/4" x 1" x 1 1/4"	241,00
B2-8-4	1 1/2" x 1/2" x 1 1/2"	296,00
B2-8-5	1 1/2" x 3/4" x 1 1/2"	296,00
B2-8-6	1 1/2" x 1" x 1 1/2"	296,00
B2-8-7	1 1/2" x 1 1/4" x 1 1/2"	296,00
B2-9-4	2" x 1/2" x 2"	441,25
B2-9-5	2" x 3/4" x 2"	441,25
B2-9-6	2" x 1" x 2"	441,25
B2-9-7	2" x 1 1/4" x 2"	441,25
B2-9-8	2" x 1 1/2" x 2"	441,25

Overbøjning muf/muf

AISI 316 - BSPP



Varenr.	BSPP	DKK
B0-3	3/8"	136,25
B0-4	1/2"	157,75
B0-5	3/4"	194,50
B0-6	1"	311,25
B0-7	1 1/4"	320,00

Kryds m. muffe

AISI 316 - BSPP



Varenr.	BSPP	DKK
B3-1	1/8"	70,75
B3-2	1/4"	70,75
B3-3	3/8"	90,10
B3-4	1/2"	100,25
B3-5	3/4"	132,00
B3-6	1"	218,00
B3-7	1 1/4"	342,75
B3-8	1 1/2"	378,25
B3-9	2"	531,75
B3-10	2 1/2"	1201,00
B3-11	3"	1683,25
B3-12	4"	2749,25

Vinkel 90° muf/nip

AISI 316 - BSPP x BSPT



Varenr.	BSPP x BSPT	DKK
B4-1	1/8"	36,35
B4-2	1/4"	39,10
B4-3	3/8"	44,20
B4-4	1/2"	52,65
B4-5	3/4"	82,50
B4-6	1"	136,25
B4-7	1 1/4"	182,00
B4-8	1 1/2"	214,00
B4-9	2"	361,00
B4-10	2 1/2"	783,75
B4-11	3"	1140,25
B4-12	4"	1984,00

Vinkel 45° muf/muffe

AISI 316 - BSPP



Varenr.	BSPP	DKK
B5-1	1/8"	35,50
B5-2	1/4"	37,45
B5-3	3/8"	50,10
B5-4	1/2"	55,20
B5-5	3/4"	82,50
B5-6	1"	127,75
B5-7	1 1/4"	180,75
B5-8	1 1/2"	208,00
B5-9	2"	327,75
B5-10	2 1/2"	736,25
B5-11	3"	1049,75
B5-12	4"	1431,75

Vinkel 45° muf/nippel

AISI 316 - BSPT x BSPP



Varenr.	BSPT x BSPP	DKK
B5U-1	1/8"	44,45
B5U-2	1/4"	55,20
B5U-3	3/8"	60,05
B5U-4	1/2"	70,15
B5U-5	3/4"	99,35
B5U-6	1"	150,25
B5U-7	1 1/4"	229,25
B5U-8	1 1/2"	296,00
B5U-9	2"	436,00
B5U-10	2 1/2"	1329,75
B5U-11	3"	1958,25
B5U-12	4"	3689,50

Vinkel 45° med beslag

AISI 316 - BSPP

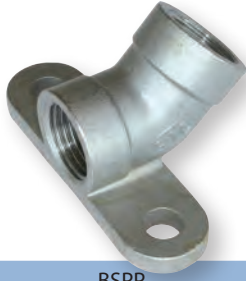

Varenr.	BSPP	DKK
B5V-4	1/2"	106,00

Vinkel 60° med beslag

AISI 316 - BSPP



Varenr.	BSPP	DKK
B5V-4-1	1/2"	106,00

Vinkel 75° med beslag

AISI 316 - BSPP



Varenr.	BSPP	DKK
B5V-4-2	1/2"	106,00

Vinkel 90° med beslag

AISI 316 - BSPP



Varenr.	BSPP	DKK
B5V-4-3	1/2"	106,00

Rørbøjning 90° nip/nip

AISI 316 - BSPT



Varenr.	BSPT	DKK
B38-1	1/8"	191,75
B38-2	1/4"	191,75
B38-3	3/8"	250,00
B38-4	1/2"	160,25
B38-5	3/4"	213,00
B38-6	1"	372,00
B38-7	1 1/4"	477,25
B38-8	1 1/2"	613,75
B38-9	2"	1134,25
B38-10	2 1/2"	1524,50

Y-stk m. muffe

AISI 316 - BSPP



Varenr.	BSPP	DKK
B5Y-1	1/8"	68,00
B5Y-2	1/4"	95,55
B5Y-3	3/8"	105,75
B5Y-4	1/2"	125,50
B5Y-5	3/4"	186,25
B5Y-6	1"	269,75
B5Y-7	1 1/4"	424,75
B5Y-8	1 1/2"	525,25
B5Y-9	2"	765,50
B5Y-10	2 1/2"	1501,75
B5Y-11	3"	1934,50
B5Y-12	4"	2885,25

Brystnippel

AISI 316 - BSPT



Varenr.	BSPT	DKK
B9-1	1/8"	24,15
B9-2	1/4"	26,15
B9-3	3/8"	31,00
B9-4	1/2"	38,30
B9-5	3/4"	50,65
B9-6	1"	83,30
B9-7	1 1/4"	131,00
B9-8	1 1/2"	152,75
B9-9	2"	234,75
B9-10	2 1/2"	423,50
B9-11	3"	491,75
B9-12	4"	905,75

Brystnippel reduktion

AISI 316 - BSPT



Varenr.	BSPT	DKK
B10-2-1	1/4" x M5	70,15
B10-2	1/4" x 1/8"	36,35
B10-3-1	3/8" x 1/8"	40,25
B10-3	3/8" x 1/4"	40,25
B10-4-1	1/2" x 1/8"	52,20
B10-4-2	1/2" x 1/4"	52,20
B10-4	1/2" x 3/8"	52,20
B10-5-1	3/4" x 1/8"	63,65
B10-5-2	3/4" x 1/4"	63,65
B10-5-3	3/4" x 3/8"	63,65
B10-5	3/4" x 1/2"	63,65
B10-6-2	1" x 1/4"	94,50
B10-6-3	1" x 3/8"	94,50
B10-6-4	1" x 1/2"	94,50
B10-6	1" x 3/4"	94,50
B10-7-4	1 1/4" x 1/2"	135,25
B10-7-5	1 1/4" x 3/4"	135,25
B10-7	1 1/4" x 1"	135,25
B10-8-4	1 1/2" x 1/2"	180,75
B10-8-5	1 1/2" x 3/4"	180,75
B10-8-6	1 1/2" x 1"	180,75
B10-8	1 1/2" x 1 1/4"	180,75
B10-9-4	2" x 1/2"	284,75
B10-9-5	2" x 3/4"	284,75
B10-9-6	2" x 1"	284,75
B10-9-7	2" x 1 1/4"	284,75
B10-9	2" x 1 1/2"	284,75
B10-10-6	2 1/2" x 1"	424,75
B10-10-7	2 1/2" x 1 1/4"	424,75
B10-10-8	2 1/2" x 1 1/2"	424,75
B10-10	2 1/2" x 2"	424,75
B10-11-6	3" x 1"	579,50
B10-11-7	3" x 1 1/4"	579,50
B10-11-8	3" x 1 1/2"	579,50
B10-11-9	3" x 2"	579,50
B10-11	3" x 2 1/2"	579,50
B10-12	4" x 3"	1049,75

Nippelmuffe

AISI 316 - BSPTxBSPP



BSPT

BSPP

Varenr.	BSPTxBSPP	DKK
B28-2	1/4" x 1/8"	26,50
B28-3-1	3/8" x 1/8"	30,15
B28-3	3/8" x 1/4"	30,15
B28-4-1	1/2" x 1/8"	33,50
B28-4-2	1/2" x 1/4"	33,50
B28-4	1/2" x 3/8"	33,50
B28-5-1	3/4" x 1/8"	44,45
B28-5-2	3/4" x 1/4"	44,45
B28-5-3	3/4" x 3/8"	44,45
B28-5	3/4" x 1/2"	44,45
B28-6-2	1" x 1/4"	71,55
B28-6-3	1" x 3/8"	71,55
B28-6-4	1" x 1/2"	71,55
B28-6	1" x 3/4"	71,55
B28-7-4	1 1/4" x 1/2"	107,75
B28-7-5	1 1/4" x 3/4"	107,75
B28-7	1 1/4" x 1"	107,75
B28-8-4	1 1/2" x 1/2"	135,25
B28-8-5	1 1/2" x 3/4"	135,25
B28-8-6	1 1/2" x 1"	135,25
B28-8	1 1/2" x 1 1/4"	135,25
B28-9-4	2" x 1/2"	226,00
B28-9-5	2" x 3/4"	226,00
B28-9-6	2" x 1"	226,00
B28-9-7	2" x 1 1/4"	226,00
B28-9	2" x 1 1/2"	226,00
B28-10-6	2 1/2" x 1"	405,00
B28-10-7	2 1/2" x 1 1/4"	405,00
B28-10-8	2 1/2" x 1 1/2"	405,00
B28-10	2 1/2" x 2"	405,00
B28-11-6	3" x 1"	539,50
B28-11-7	3" x 1 1/4"	539,50
B28-11-8	3" x 1 1/2"	539,50
B28-11-9	3" x 2"	539,50
B28-11	3" x 2 1/2"	539,50
B28-12-9	4" x 2"	991,25
B28-12-10	4" x 2 1/2"	991,25
B28-12	4" x 3"	991,25
B28-13	5" x 4"	5344,75

Spidsmuffe

AISI 316 - BSPPxBSPT



BSPT

BSPP

Varenr.	BSPPxBSPT	DKK
B29-2	1/4" x 1/8"	39,10
B29-2-2	1/4" x 1/4"	39,10
B29-3-1	3/8" x 1/8"	46,20
B29-3	3/8" x 1/4"	46,20
B29-3-3	3/8" x 3/8"	46,20
B29-4-1	1/2" x 1/8"	59,00
B29-4-2	1/2" x 1/4"	59,00
B29-4	1/2" x 3/8"	59,00
B29-4-4	1/2" x 1/2"	59,00
B29-5-1	3/4" x 1/8"	81,10
B29-5-2	3/4" x 1/4"	81,10
B29-5-3	3/4" x 3/8"	81,10
B29-5	3/4" x 1/2"	81,10
B29-5-5	3/4" x 3/4"	81,10
B29-6-1	1" x 1/8"	126,75
B29-6-2	1" x 1/4"	126,75
B29-6-3	1" x 3/8"	126,75
B29-6-4	1" x 1/2"	126,75
B29-6	1" x 3/4"	126,75
B29-6-6	1" x 1"	126,75
B29-7-4	1 1/4" x 1/2"	195,25
B29-7-5	1 1/4" x 3/4"	195,25
B29-7	1 1/4" x 1"	195,25
B29-7-7	1 1/4" x 1 1/4"	195,25
B29-8-2	1 1/2" x 1/4"	255,50
B29-8-4	1 1/2" x 1/2"	255,50
B29-8-5	1 1/2" x 3/4"	255,50
B29-8-6	1 1/2" x 1"	255,50
B29-8	1 1/2" x 1 1/4"	255,50
B29-8-8	1 1/2" x 1 1/2"	255,50
B29-9-6	2" x 1"	365,00
B29-9-7	2" x 1 1/4"	365,00
B29-9-8	2" x 1 1/2"	365,00
B29-9-9	2" x 2"	365,00

Formmuffe

AISI 316 - BSPP



Varenr.	BSPP	DKK
B18-2	1/4" x 1/8"	34,00
B18-3-1	3/8" x 1/8"	53,50
B18-3	3/8" x 1/4"	40,25
B18-4-1	1/2" x 1/8"	65,55
B18-4-2	1/2" x 1/4"	65,55
B18-4	1/2" x 3/8"	49,25
B18-5-1	3/4" x 1/8"	84,65
B18-5-2	3/4" x 1/4"	90,35
B18-5-3	3/4" x 3/8"	90,35
B18-5	3/4" x 1/2"	67,75
B18-6-2	1" x 1/4"	102,25
B18-6-3	1" x 3/8"	141,00
B18-6-4	1" x 1/2"	141,00
B18-6	1" x 3/4"	106,00
B18-7-4	1 1/4" x 1/2"	210,25
B18-7-5	1 1/4" x 3/4"	210,25
B18-7	1 1/4" x 1"	156,50
B18-8-4	1 1/2" x 1/2"	253,25
B18-8-5	1 1/2" x 3/4"	253,25
B18-8-6	1 1/2" x 1"	253,25
B18-8	1 1/2" x 1 1/4"	190,25
B18-9-4	2" x 1/2"	392,75
B18-9-5	2" x 3/4"	392,75
B18-9-6	2" x 1"	392,75
B18-9-7	2" x 1 1/4"	392,75
B18-9	2" x 1 1/2"	294,25
B18-10-6	2 1/2" x 1"	617,50
B18-10-7	2 1/2" x 1 1/4"	617,50
B18-10-8	2 1/2" x 1 1/2"	617,50
B18-10	2 1/2" x 2"	538,25
B18-11-6	3" x 1"	800,50
B18-11-7	3" x 1 1/4"	800,50
B18-11-8	3" x 1 1/2"	800,50
B18-11-9	3" x 2"	856,00
B18-11	3" x 2 1/2"	712,25
B18-12-9	4" x 2"	1339,00
B18-12-10	4" x 2 1/2"	1339,00
B18-12	4" x 3"	1271,25

Rørprop firkant

AISI 316 - BSPT



Varenr.	BSPT	DKK
B11-1	1/8"	16,35
B11-2	1/4"	17,40
B11-3	3/8"	20,35
B11-4	1/2"	24,40
B11-5	3/4"	33,50
B11-6	1"	50,65
B11-7	1 1/4"	73,15
B11-8	1 1/2"	95,55
B11-9	2"	112,00
B11-10	2 1/2"	242,00
B11-11	3"	310,00
B11-12	4"	620,00

Rørprop sekskant

AISI 316 - BSPT



Varenr.	BSPT	DKK
B12-1	1/8"	17,40 α
B12-2	1/4"	19,20 α
B12-3	3/8"	22,45
B12-4	1/2"	28,10
B12-5	3/4"	35,50
B12-6	1"	58,45
B12-7	1 1/4"	82,50
B12-8	1 1/2"	117,25
B12-9	2"	176,50
B12-10	2 1/2"	321,50
B12-11	3"	361,00
B12-12	4"	823,00

α = massiv pga. lille størrelse

Rørprop massiv

AISI 316 - BSPT



Varenr.	BSPT	DKK
B12s-1	1/8"	17,40
B12s-2	1/4"	19,20
B12s-3	3/8"	24,15
B12s-4	1/2"	35,20
B12s-5	3/4"	61,45
B12s-6	1"	104,25
B12s-7	1 1/4"	172,50
B12s-8	1 1/2"	227,00
B12s-9	2"	418,25

Rørprop Unbrako

AISI 316 - BSPP

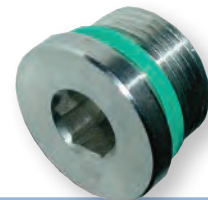

Varenr.	BSPP	DKK
B12-1-1	1/8"	99,35
B12-2-1	1/4"	132,00
B12-3-1	3/8"	216,75
B12-4-1	1/2"	283,25
B12-5-1	3/4"	453,75
B12-6-1	1"	511,25

Slutmuffe sekskant

AISI 316 - BSPP



Varenr.	BSPP	DKK
B17-1	1/8"	20,35
B17-2	1/4"	21,15
B17-3	3/8"	25,40
B17-4	1/2"	32,40
B17-5	3/4"	53,50
B17-6	1"	84,40
B17-7	1 1/4"	115,00
B17-8	1 1/2"	145,75
B17-9	2"	269,75
B17-10	2 1/2"	378,25
B17-11	3"	613,75
B17-12	4"	1006,25

Kontramøtrik

AISI 316 - BSPP



Varenr.	BSPP	DKK
B15-1	1/8"	20,35
B15-2	1/4"	22,45
B15-3	3/8"	26,15
B15-4	1/2"	28,10
B15-5	3/4"	35,50
B15-6	1"	47,05
B15-7	1 1/4"	56,25
B15-8	1 1/2"	75,10
B15-9	2"	108,75
B15-10	2 1/2"	220,75
B15-11	3"	261,00
B15-12	4"	491,75

Slangenippel

AISI 316 - BSPT



Varenr.	Ø × BSPT	DKK
B14-1-6	6 × 1/8"	56,25
B14-2	6 × 1/4"	44,60
B14-4-6	6 × 1/2"	95,55
B14-1-7	7 × 1/8"	35,25
B14-3-7	7 × 3/8"	78,10
B14-1-8	8 × 1/8"	56,25
B14-2-8	8 × 1/4"	64,95
B14-3-8	8 × 3/8"	78,10
B14-4-8	8 × 1/2"	95,55
B14-2-9	9 × 1/4"	64,95
B14-1-10	10 × 1/8"	86,80
B14-2-10	10 × 1/4"	64,95
B14-3	10 × 3/8"	53,75
B14-4-10	10 × 1/2"	95,55
B14-2-11	11 × 1/4"	64,95
B14-3-13	13 × 3/8"	78,10
B14-4	13 × 1/2"	64,95
B14-4-14	14 × 1/2"	95,55
B14-3-16	16 × 3/8"	78,10
B14-4-16	16 × 1/2"	95,55
B14-5-16	16 × 3/4"	145,75
B14-4-19	19 × 1/2"	95,55
B14-5	19 × 3/4"	100,50
B14-6-19	19 × 1"	133,00
B14-4-20	20 × 1/2"	95,55
B14-5-20	20 × 3/4"	145,75
B14-6-20	20 × 1"	133,00
B14-5-25	25 × 3/4"	145,75
B14-6	25 × 1"	136,25
B14-7	32 × 1 1/4"	183,50
B14-8	39 × 1 1/2"	299,00
B14-9	51 × 2"	440,50
B14-10	63 × 2 1/2"	599,25
B14-11	76 × 3"	793,00
B14-12	105 × 4"	1364,75

Slangenippel m. indv. gevind

AISI 316 - BSPP



Varenr.	Ø × BSPP	DKK
B14I-1	6 × 1/8"	55,70
B14I-2	9 × 1/4"	55,70
B14I-3	11 × 3/8"	67,20
B14I-4	14 × 1/2"	81,40
B14I-5	20 × 3/4"	125,75
B14I-6	27 × 1"	171,50
B14I-7	33 × 1 1/4"	229,00
B14I-8	39 × 1 1/2"	372,75
B14I-9	50 × 2"	454,75

Slangenippel 90°

AISI 316 - BSPT

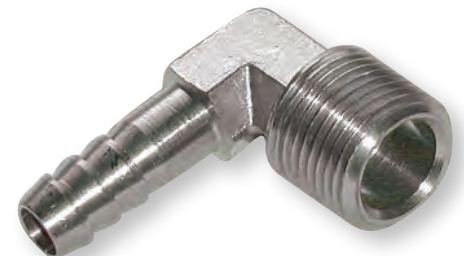

Varenr.	Ø × BSPT	DKK
B14V-2-6	6 × 1/4"	55,70
B14V-2-8	8 × 1/4"	63,90
B14V-3-10	10 × 3/8"	75,90
B14V-4-10	10 × 1/2"	109,75
B14V-4-12	12 × 1/2"	119,00
B14V-5-19	19 × 3/4"	128,50

Slangeforskruing flad

AISI 316 - BSPP

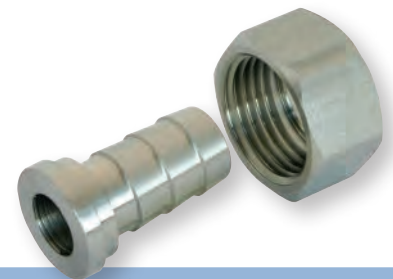

Varenr.	Ø × BSPP	DKK
B46-2	6 × 1/4"	101,25
B46-3	10 × 3/8"	118,50
B46-4	13 × 1/2"	137,75
B46-5	20 × 3/4"	162,00
B46-6	25 × 1"	304,00

HUSK PAKNINGER



Slangenippel t. svejs

AISI 316



Varenr.	Ø × dim	DKK
B14s-1	10,2 × 1/8"	39,80
B14s-2	13,5 × 1/4"	39,80
B14s-3	17,2 × 3/8"	48,35
B14s-4	21,3 × 1/2"	57,60
B14s-5	26,9 × 3/4"	67,75
B14s-6	33,7 × 1"	99,35
B14s-7	42,4 × 1 1/4"	136,25
B14s-8	48,3 × 1 1/2"	163,75
B14s-9	60,3 × 2"	217,75
B14s-10	76,1 × 2 1/2"	327,25
B14s-11	88,9 × 3"	474,75
B14s-12	114,3 × 4"	681,25

Slangenippel af rør

AISI 316 - BSPT



Varenr.	Ø × BSPT	DKK
B14G-2	13,5 × 1/4"	39,80
B14G-3	17,2 × 3/8"	48,35
B14G-4	21,3 × 1/2"	57,60
B14G-5	26,9 × 3/4"	67,75
B14G-6	33,7 × 1"	99,35
B14G-7	42,4 × 1 1/4"	136,25
B14G-8	48,3 × 1 1/2"	163,75
B14G-9	60,3 × 2"	217,75
B14G-10	76,1 × 2 1/2"	327,25
B14G-11	88,9 × 3"	474,75
B14G-12	114,3 × 4"	682,50

Slangesamler

AISI 304



Varenr.	dim	L mm	DKK
LB3-4	13,5 ~ 1/2"	79,8	105,25
LB3-5	19,7 ~ 3/4"	99,8	134,75
LB3-6	26,0 ~ 1"	99,8	202,00
LB3-7	32,3 ~ 1 1/4"	99,8	268,50
LB3-8	38,7 ~ 1 1/2"	99,8	356,00
LB3-9	51,4 ~ 2"	111	511,00
LB3-10	64,7 ~ 2 1/2"	136	926,25
LB3-11	77,5 ~ 3"	146	1189,75
LB3-12	102,8 ~ 4"	171	1998,25
LB3-13	128,3 ~ 5"	236	3485,75
LB3-14	153,6 ~ 6"	255	4465,25
LB3-16	204,5 ~ 8"	291	8631,50

Slangenippel

AISI 304 - BSPP



Varenr.	Ø × BSPP	L mm	DKK
LB2-4	13,5 × 1/2"	75	50,65
LB2-5	19,7 × 3/4"	77	77,25
LB2-6	26,0 × 1"	81	103,00
LB2-7	32,3 × 1 1/4"	88	120,75
LB2-8	38,7 × 1 1/2"	98	188,50
LB2-9	51,4 × 2"	108	260,00
LB2-10	64,7 × 2 1/2"	133	400,75
LB2-11	77,5 × 3"	143	528,00
LB2-12	102,8 × 4"	168	917,50
LB2-13	128,3 × 5"	233	1827,25
LB2-14	153,6 × 6"	252	2266,00
LB2-16	204,5 × 8"	288	3898,75

Union kon højtryk nippel/ muffe

AISI 316 - BSPT×BSPP



Max 40 bar

Varenr.	BSPP×BSPT	DKK
BH8-2	1/4"	341,25
BH8-3	3/8"	341,25
BH8-4	1/2"	515,75
BH8-5	3/4"	535,75
BH8-6	1"	675,75

Union konisk muffe/muffe

AISI 316 - BSPP



Varenr.	BSPP	DKK
B6-1	1/8"	85,20
B6-2	1/4"	85,20
B6-3	3/8"	93,40
B6-4	1/2"	108,00
B6-5	3/4"	165,00
B6-6	1"	258,00
B6-7	1 1/4"	239,25
B6-8	1 1/2"	417,25
B6-9	2"	627,00
B6-10	2 1/2"	972,50
B6-11	3"	1286,50
B6-12	4"	2225,00

Union konisk nippel/muffe

AISI 316 - BSPT×BSPP



Varenr.	BSPP×BSPT	DKK
B8-1	1/8"	90,90
B8-2	1/4"	90,90
B8-3	3/8"	102,75
B8-4	1/2"	117,00
B8-5	3/4"	183,00
B8-6	1"	292,75
B8-7	1 1/4"	383,00
B8-8	1 1/2"	501,25
B8-9	2"	729,50
B8-10	2 1/2"	1140,25
B8-11	3"	1570,75
B8-12	4"	2776,00

Union pakning

PTFE (TEFLON)



Varenr.	dim	DKK
BFP-2	1/4"	6,20
BFP-3	3/8"	12,80
BFP-4	1/2"	24,80
BFP-5	3/4"	25,40
BFP-6	1"	25,70
BFP-7	1 1/4"	31,55
BFP-8	1 1/2"	31,55
BFP-9	2"	69,90

Union flad muffe/muffe

AISI 316 / PTFE (TEFLON) - BSPP



Varenr.	BSPP	DKK
BF6-1	1/8"	123,25
BF6-2	1/4"	123,25
BF6-3	3/8"	136,25
BF6-4	1/2"	155,25
BF6-5	3/4"	222,00
BF6-6	1"	312,50
BF6-7	1 1/4"	419,50
BF6-8	1 1/2"	514,25
BF6-9	2"	814,00
BF6-10	2 1/2"	1129,00
BF6-11	3"	1751,00
BF6-12	4"	2794,50

Union flad muffe/nippel

AISI 316 / PTFE - BSPP×BSPT



Varenr.	BSPP×BSPT	DKK
BF8-1	1/8"	123,50
BF8-2	1/4"	123,25
BF8-3	3/8"	136,25
BF8-4	1/2"	155,25
BF8-5	3/4"	222,00
BF8-6	1"	312,50
BF8-7	1 1/4"	419,50
BF8-8	1 1/2"	514,25
BF8-9	2"	814,00
BF8-10	2 1/2"	1129,00
BF8-11	3"	1752,25
BF8-12	4"	2794,50

Union konisk m. svejseender AISI 316



Varenr.	dim	DKK
B7-1	10,2 ~ 1/8"	88,75
B7-2	13,5 ~ 1/4"	88,75
B7-3	17,2 ~ 3/8"	98,30
B7-4	21,3 ~ 1/2"	108,00
B7-5	26,9 ~ 3/4"	145,75
B7-6	33,7 ~ 1"	211,75
B7-7	42,4 ~ 1 1/4"	318,75
B7-8	48,3 ~ 1 1/2"	392,75
B7-9	60,3 ~ 2"	272,00
B7-10	76,1 ~ 2 1/2"	884,50
B7-11	88,9 ~ 3"	1221,75
B7-12	114,3 ~ 4"	1945,75

Union konisk muffe/svejs AISI 316 - BSPP



Varenr.	Ø × BSPP	DKK
B6B7-1	10,2 × 1/8"	157,75
B6B7-2	13,5 × 1/4"	135,25
B6B7-3	17,2 × 3/8"	148,75
B6B7-4	21,3 × 1/2"	157,75
B6B7-5	26,9 × 3/4"	196,50
B6B7-6	33,7 × 1"	266,50
B6B7-7	42,4 × 1 1/4"	526,50
B6B7-8	48,3 × 1 1/2"	634,75
B6B7-9	60,3 × 2"	864,25
B6B7-10	76,1 × 2 1/2"	1871,75
B6B7-11	88,9 × 3"	2697,75
B6B7-12	114,3 × 4"	4266,50

Union konisk nippel/svejs AISI 316 - BSPT



Varenr.	Ø × BSPT	DKK
B8B7-1	10,2 × 1/8"	157,75
B8B7-2	13,5 × 1/4"	135,25
B8B7-3	17,2 × 3/8"	148,75
B8B7-4	21,3 × 1/2"	157,75
B8B7-5	26,9 × 3/4"	196,50
B8B7-6	33,7 × 1"	266,50
B8B7-7	42,4 × 1 1/4"	526,50
B8B7-8	48,3 × 1 1/2"	634,75
B8B7-9	60,3 × 2"	864,25
B8B7-10	76,1 × 2 1/2"	1871,75
B8B7-11	88,9 × 3"	2697,75
B8B7-12	114,3 × 4"	4266,50

Union flad m. svejseender AISI 316 / PTFE (TEFLON)



Varenr.	Ø	DKK
BF7-1	10,2 ~ 1/8"	157,75
BF7-2	13,5 ~ 1/4"	135,25
BF7-3	17,2 ~ 3/8"	186,25
BF7-4	21,3 ~ 1/2"	157,75
BF7-5	26,9 ~ 3/4"	196,50
BF7-6	33,7 ~ 1"	267,50
BF7-7	42,4 ~ 1 1/4"	526,50
BF7-8	48,3 ~ 1 1/2"	634,75
BF7-9	60,3 ~ 2"	864,25
BF7-10	76,1 ~ 2 1/2"	1871,75
BF7-11	88,9 ~ 3"	2697,75
BF7-12	114,3 ~ 4"	4266,50

Union flad svejs/muffe AISI 316 / PTFE (TEFLON) - BSPP



Varenr.	Ø × BSPP	DKK
BF6B7-1	10,2 × 1/8"	157,75
BF6B7-2	13,5 × 1/4"	135,25
BF6B7-3	17,2 × 3/8"	148,75
BF6B7-4	21,3 × 1/2"	157,75
BF6B7-5	26,9 × 3/4"	196,50
BF6B7-6	33,7 × 1"	266,50
BF6B7-7	42,4 × 1 1/4"	526,50
BF6B7-8	48,3 × 1 1/2"	634,75
BF6B7-9	60,3 × 2"	864,25
BF6B7-10	76,1 × 2 1/2"	1871,75
BF6B7-11	88,9 × 3"	2697,75
BF6B7-12	114,3 × 4"	4266,50

Union flad svejs/nippel AISI 316 / PTFE (TEFLON) - BSPT



Varenr.	Ø × BSPT	DKK
BF8B7-1	10,2 × 1/8"	157,75
BF8B7-2	13,5 × 1/4"	135,25
BF8B7-3	17,2 × 3/8"	148,75
BF8B7-4	21,3 × 1/2"	157,75
BF8B7-5	26,9 × 3/4"	196,50
BF8B7-6	33,7 × 1"	266,50
BF8B7-7	42,4 × 1 1/4"	526,50
BF8B7-8	48,3 × 1 1/2"	634,75
BF8B7-9	60,3 × 2"	864,25
BF8B7-10	76,1 × 2 1/2"	1871,75
BF8B7-11	88,9 × 3"	2697,75
BF8B7-12	114,3 × 4"	4266,50

Union konisk studs/muffe

AISI 316 - BSPP

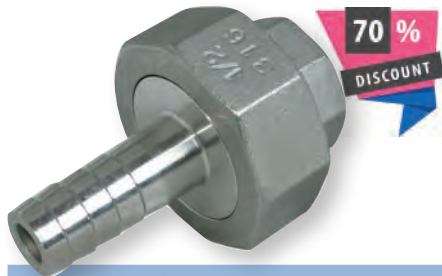

Varenr.	Ø × BSPP	DKK
B6s-1	6,5 × 1/8"	47,30 ₺
B6s-2	6,35 × 1/4"	40,60 ₺
B6s-2-1	9 × 1/4"	40,60 ₺
B6s-3	9,5 × 3/8"	44,60 ₺
B6s-3-1	11 × 3/8"	44,60 ₺
B6s-4	12,7 × 1/2"	47,30 ₺
B6s-5-1	20,5 × 3/4"	58,95 ₺
B6s-6-1	27 × 1"	79,90 ₺
B6s-7	31,8 × 1 1/4"	158,00 ₺
B6s-7-1	33 × 1 1/4"	158,00 ₺
B6s-8	38,1 × 1 1/2"	190,50 ₺
B6s-8-1	39,5 × 1 1/2"	190,50 ₺
B6s-9	50,8 × 2"	259,50 ₺
B6s-9-1	52 × 2"	259,50 ₺

₺ = så længe lager havet

Union konisk studs/nippel

AISI 316 - BSPT



Varenr.	Ø × BSPT	DKK
B8s-2	6,35 × 1/4"	40,60 ₺
B8s-2-1	9 × 1/4"	40,60 ₺
B8s-3	9,5 × 3/8"	44,60 ₺
B8s-3-1	11 × 3/8"	44,60 ₺
B8s-4	12,7 × 1/2"	47,30 ₺
B8s-4-1	14 × 1/2"	47,30 ₺
B8s-6	25,4 × 1"	79,90 ₺
B8s-6-1	27 × 1"	79,90 ₺
B8s-7	31,8 × 1 1/4"	158,00 ₺
B8s-7-1	33 × 1 1/4"	158,00 ₺
B8s-8	38,1 × 1 1/2"	190,50 ₺
B8s-8-1	39,5 × 1 1/2"	190,50 ₺
B8s-9	50,8 × 2"	259,50 ₺
B8s-9-1	52 × 2"	259,50 ₺

₺ = så længe lager havet

Union konisk studs/svejs

AISI 316

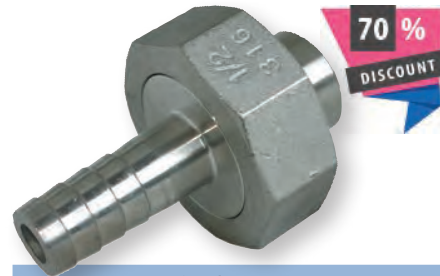

Varenr.	Ø × dim	DKK
B7s-1	6,5 × 1/8"	47,30 ₺
B7s-2	6,35 × 1/4"	40,60 ₺
B7s-2-1	9 × 1/4"	40,60 ₺
B7s-3	9,5 × 3/8"	44,60 ₺
B7s-3-1	11 × 3/8"	44,60 ₺
B7s-4	12,7 × 1/2"	47,30 ₺
B7s-4-1	14 × 1/2"	47,30 ₺
B7s-5	19,05 × 3/4"	58,95 ₺
B7s-5-1	20,5 × 3/4"	58,95 ₺
B7s-6	25,4 × 1"	79,90 ₺
B7s-6-1	27 × 1"	79,90 ₺
B7s-7	31,8 × 1 1/4"	158,00 ₺
B7s-7-1	33 × 1 1/4"	158,00 ₺
B7s-8	38,1 × 1 1/2"	190,50 ₺
B7s-8-1	39,5 × 1 1/2"	190,50 ₺
B7s-9	50,8 × 2"	259,50 ₺
B7s-9-1	52 × 2"	259,50 ₺

₺ = så længe lager havet

Union flad studs/muffe

AISI 316 / PTFE (TEFLON) - BSPP

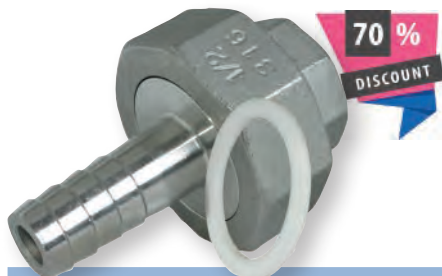

Varenr.	Ø × BSPP	DKK
BF6s-1	6,5 × 1/8"	47,30 ₺
BF6s-2	6,35 × 1/4"	40,60 ₺
BF6s-2-1	9 × 1/4"	40,60 ₺
BF6s-3	9,5 × 3/8"	44,60 ₺
BF6s-3-1	11 × 3/8"	44,60 ₺
BF6s-4	12,7 × 1/2"	47,30 ₺
BF6s-5-1	20,5 × 3/4"	58,95 ₺
BF6s-6-1	27 × 1"	79,90 ₺
BF6s-7	31,8 × 1 1/4"	158,00 ₺
BF6s-7-1	33 × 1 1/4"	158,00 ₺
BF6s-8	38,1 × 1 1/2"	190,50 ₺
BF6s-9	50,8 × 2"	259,50 ₺
BF6s-9-1	52 × 2"	259,50 ₺

₺ = så længe lager havet

Union flad studs/nippel

AISI 316 / PTFE (TEFLON) - BSPT



Varenr.	Ø × BSPT	DKK
BF8s-1	6,5 × 1/8"	47,30 ₺
BF8s-2	6,35 × 1/4"	40,60 ₺
BF8s-2-1	9 × 1/4"	40,60 ₺
BF8s-3	9,5 × 3/8"	44,60 ₺
BF8s-3-1	11 × 3/8"	44,60 ₺
BF8s-4	12,7 × 1/2"	47,30 ₺
BF8s-4-1	14 × 1/2"	47,30 ₺
BF8s-5	19,05 × 3/4"	58,95 ₺
BF8s-5-1	20,5 × 3/4"	58,95 ₺
BF8s-6-1	27 × 1"	79,90 ₺
BF8s-7	31,8 × 1 1/4"	158,00 ₺
BF8s-7-1	33 × 1 1/4"	158,00 ₺
BF8s-8	38,1 × 1 1/2"	190,50 ₺
BF8s-8-1	39,5 × 1 1/2"	190,50 ₺
BF8s-9	50,8 × 2"	259,50 ₺
BF8s-9-1	52 × 2"	259,50 ₺

₺ = så længe lager havet

Union flad studs/svejs

AISI 316 / PTFE (TEFLON)

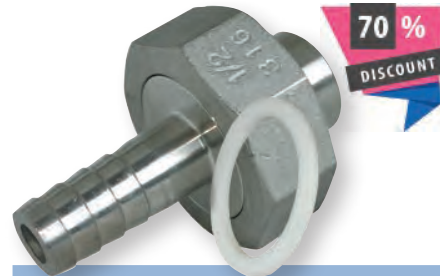

Varenr.	Ø × dim	DKK
BF7s-1	6,5 × 1/8"	47,30 ₺
BF7s-2	6,35 × 1/4"	40,60 ₺
BF7s-2-1	9 × 1/4"	40,60 ₺
BF7s-3	9,5 × 3/8"	44,60 ₺
BF7s-3-1	11 × 3/8"	44,60 ₺
BF7s-4	12,7 × 1/2"	47,30 ₺
BF7s-4-1	14 × 1/2"	47,30 ₺
BF7s-5	19,05 × 3/4"	58,95 ₺
BF7s-5-1	20,5 × 3/4"	58,95 ₺
BF7s-6	25,4 × 1"	79,90 ₺
BF7s-6-1	27 × 1"	79,90 ₺
BF7s-7	31,8 × 1 1/4"	158,00 ₺
BF7s-7-1	33 × 1 1/4"	158,00 ₺
BF7s-8	38,1 × 1 1/2"	190,50 ₺
BF7s-8-1	39,5 × 1 1/2"	190,50 ₺
BF7s-9	50,8 × 2"	259,50 ₺
BF7s-9-1	52 × 2"	259,50 ₺

₺ = så længe lager havet

Union konisk studs/studs

AISI 316



Varenr.	Ø	DKK
B14U-1	6,5	47,30 α
B14U-2	6,35	40,60 α
B14U-2-1	9	40,60 α
B14U-3	9,5	44,60 α
B14U-3-1	11	44,60 α
B14U-4	12,7	47,30 α
B14U-4-1	14	47,30 α
B14U-5	19,05	58,95 α
B14U-5-1	20,5	58,95 α
B14U-6	25,4	79,90 α
B14U-6-1	27	79,90 α
B14U-7	31,8	158,00 α
B14U-7-1	33	158,00 α
B14U-8	38,1	190,50 α
B14U-8-1	39,5	190,50 α
B14U-9	50,8	259,50 α
B14U-9-1	52	259,50 α

α = så længe lager haves

Union 90° konisk studs/muf

AISI 316 - BSPP



Varenr.	Ø × BSPP	DKK
B20s-1	6,5 × 1/8"	47,30 α
B20s-2	6,35 × 1/4"	40,60 α
B20s-2-1	9 × 1/4"	40,60 α
B20s-3	9,5 × 3/8"	44,60 α
B20s-3-1	11 × 3/8"	44,60 α
B20s-4	12,7 × 1/2"	47,30 α
B20s-7	31,8 × 1 1/4"	158,00 α
B20s-7-1	33 × 1 1/4"	158,00 α
B20s-8	38,1 × 1 1/2"	190,50 α
B20s-8-1	39,5 × 1 1/2"	190,50 α
B20s-9	50,8 × 2"	259,50 α
B20s-9-1	52 × 2"	259,50 α

α = så længe lager haves

Union 90° konisk nip/muf

AISI 316 - BSPT×BSPP



Varenr.	BSPT×BSPP	DKK
B19-1	1/8"	43,05 α
B19-3	3/8"	159,00
B19-4	1/2"	176,50
B19-5	3/4"	247,25
B19-6	1"	374,50
B19-7	1 1/4"	476,25
B19-8	1 1/2"	612,50
B19-9	2"	900,25

α = så længe lager haves

Union 90° konisk muf/muf

AISI 316 - BSPP



Varenr.	BSPP	DKK
B20-2	1/4"	112,50
B20-3	3/8"	141,00
B20-4	1/2"	159,00
B20-5	3/4"	224,50
B20-6	1"	345,75
B20-7	1 1/4"	440,00
B20-8	1 1/2"	550,75
B20-9	2"	830,75

Union flad studs/studs

AISI 316 / PTFE (TEFLON)



Varenr.	Ø	DKK
BF14U-1	6,5	47,30 α
BF14U-2	6,35	40,60 α
BF14U-2-1	9	40,60 α
BF14U-3	9,5	44,60 α
BF14U-3-1	11	44,60 α
BF14U-4	12,7	47,30 α
BF14U-4-1	14	47,30 α
BF14U-5	19,05	58,95 α
BF14U-5-1	20,5	58,95 α
BF14U-6	25,4	79,90 α
BF14U-6-1	27	79,90 α
BF14U-7	31,8	158,00 α
BF14U-7-1	33	158,00 α
BF14U-8	38,1	190,50 α
BF14U-8-1	39,5	190,50 α
BF14U-9	50,8	259,50 α
BF14U-9-1	52	259,50 α

α = så længe lager haves

Union 90° flad studs/muffe

AISI 316 / PTFE (TEFLON) - BSPP



Varenr.	Ø × BSPP	DKK
BF20s-1	6,5 × 1/8"	47,30 α
BF20s-2	6,35 × 1/4"	47,30 α
BF20s-2-1	9 × 1/4"	47,30 α
BF20s-3	9,5 × 3/8"	44,60 α
BF20s-3-1	11 × 3/8"	44,60 α
BF20s-4	12,7 × 1/2"	47,30 α
BF20s-4-1	14 × 1/2"	47,30 α
BF20s-5	19,05 × 3/4"	58,95 α
BF20s-5-1	20,5 × 3/4"	58,95 α
BF20s-6	25,4 × 1"	79,90 α
BF20s-7	31,8 × 1 1/4"	158,00 α
BF20s-7-1	33 × 1 1/4"	158,00 α
BF20s-8-1	39,5 × 1 1/2"	190,50 α
BF20s-9	50,8 × 2"	259,50 α
BF20s-9-1	52 × 2"	259,50 α

α = så længe lager haves

Union 90° flad nippel/muffe

AISI 316 / PTFE (TEFLON) - BSPT×BSPP



Varenr.	BSPT×BSPP	DKK
BF19-1	1/8"	131,25
BF19-2	1/4"	131,25
BF19-3	3/8"	159,00
BF19-4	1/2"	176,50
BF19-5	3/4"	247,75
BF19-6	1"	374,50
BF19-7	1 1/4"	475,25
BF19-8	1 1/2"	611,25
BF19-9	2"	916,00

Union 90° flad muffe/muffe

AISI 316 / PTFE (TEFLON) - BSPP



Varenr.	BSPP	DKK
BF20-1	1/8"	98,30
BF20-2	1/4"	98,30
BF20-3	3/8"	141,00
BF20-4	1/2"	159,00
BF20-5	3/4"	224,50
BF20-6	1"	345,75
BF20-7	1 1/4"	440,00
BF20-8	1 1/2"	550,25
BF20-9	2"	829,75



Dobbeltsidet fordeler

AISI 304 - BSPP



Varenr.	Ind + ud	DKK
BL5-2	2·1" + 2·2-1/2"	129,25
BL5-3	2·1" + 2·3-1/2"	191,00
BL5-4	2·1" + 2·4-1/2"	256,00
BL5-5	2·1" + 2·5-1/2"	297,00
BL5-6	2·1" + 2·6-1/2"	356,25
BL5-7	2·1" + 2·7-1/2"	414,00
BL5-8	2·1" + 2·8-1/2"	473,00
BL5-9	2·1" + 2·9-1/2"	526,25
BL5-10	2·1" + 2·10-1/2"	585,00
BL5-11	2·1" + 2·11-1/2"	643,75
BL5-12	2·1" + 2·12-1/2"	701,50
BL5-13	2·1" + 2·13-1/2"	760,25

Svivel nippel/muf 160L/min

AISI 316 - 1/2" BSPT×1/2" BSPP



Arbejdstryk: 200bar - max: 220bar
Arbejdtemperatur: +90°C
Positionsnippel

Varenr.	BSPT×BSPP	DKK
B40s-4	1/2"	1109,50

Svivel nippel/muf 40L/min

AISI 316 - BSPT×BSPP



Arbejdstryk: 350bar - max: 390bar
Arbejdtemperatur: +160°C
Max 30 RPM

Varenr.	BSPT×BSPP	DKK
B41s-2	1/4"	1982,50
B41s-3	3/8"	880,75

Svivel 90° muf/nip 80L/min

AISI 316 - 1/2" BSPT×1/2" BSPP



Arbejdstryk: 350bar - max: 390bar
Arbejdtemperatur: +90°C
Max 30 RPM

Varenr.	BSPT×BSPP	DKK
B43s-4	1/2"	4155,00

Svivel nippel/muffe 40L/min

AISI 316 - BSPP



Arbejdstryk: 250bar - max: 280bar
Arbejdtemperatur: +120°C
Max 30 RPM

med kugleleje

Varenr.	BSPP	DKK
B44s-2	1/4"	3352,50
B44s-3	3/8"	1511,25

Svivel nippel/muffe 60L/min

AISI 316 - 3/8" BSPT×3/8" BSPP



Arbejdstryk: 600bar - max: 660bar
Arbejdtemperatur: +100°C
Max 30 RPM

Varenr.	BSPT×BSPP	DKK
B45s-3	3/8"	6675,00

GEVINDFITTINGS RUSTFRI AISI 316 LIGHT



Normalt max 10bar



-20°C til +400°C



Komplet program af rustfri syrefast rørgvind fittings, voksstøbt med glatte overflader.

Vinkel 90° muf/muf

AISI 316 - BSPP - LIGHT



Varenr.	BSPP	DKK
B1-1L	1/8"	15,35
B1-2L	1/4"	16,85
B1-3L	3/8"	18,25
B1-4L	1/2"	26,40
B1-5L	3/4"	39,00
B1-6L	1"	56,65

Kryds m. muffer

AISI 316 - BSPP - LIGHT



Varenr.	BSPP	DKK
B3-2L	1/4"	32,90
B3-3L	3/8"	40,20
B3-4L	1/2"	49,55
B3-5L	3/4"	76,65
B3-6L	1"	105,25

Vinkel 45° muffe/muffe

AISI 316 - BSPP - LIGHT



Varenr.	BSPP	DKK
B5-2L	1/4"	16,85
B5-3L	3/8"	18,25
B5-4L	1/2"	26,90
B5-5L	3/4"	40,05
B5-6L	1"	57,25

T-stk m. muffer

AISI 316 - BSPP - LIGHT



Varenr.	BSPP	DKK
B2-1L	1/8"	20,50
B2-2L	1/4"	21,20
B2-3L	3/8"	26,30
B2-4L	1/2"	37,15
B2-5L	3/4"	54,05
B2-6L	1"	80,05

Vinkel 90° muf/nip

AISI 316 - BSPT×BSPP - LIGHT



Varenr.	BSPT×BSPP	DKK
B4-1L	1/8"	16,90
B4-2L	1/4"	18,25
B4-3L	3/8"	21,55
B4-4L	1/2"	25,05
B4-5L	3/4"	36,10
B4-6L	1"	56,95

Vinkel 45° muffe/nippel

AISI 316 - BSPT×BSPP - LIGHT



Varenr.	BSPT×BSPP	DKK
B5U-2L	1/4"	19,85
B5U-3L	3/8"	23,40
B5U-4L	1/2"	32,60
B5U-5L	3/4"	45,45
B5U-6L	1"	76,00

Brystnippel

AISI 316 - BSPT - LIGHT



Varenr.	BSPT	DKK
B9-1L	1/8"	12,15
B9-2L	1/4"	12,15
B9-3L	3/8"	14,75
B9-4L	1/2"	19,90
B9-5L	3/4"	26,00
B9-6L	1"	42,55

Formmuffe

AISI 316 - BSPP - LIGHT



Varenr.	BSPP	DKK
B18-3L	3/8" x 1/4"	18,25
B18-4L	1/2" x 3/8"	20,80
B18-5L	3/4" x 1/2"	30,85
B18-6L	1" x 3/4"	45,00

Slangenippel

AISI 316 - BSPT - LIGHT



Varenr.	Ø x BSPT	DKK
B14-2L	6 x 1/4"	17,60
B14-3L	10 x 3/8"	20,75
B14-4L	13 x 1/2"	22,90
B14-5L	19 x 3/4"	29,70
B14-6L	25 x 1"	47,45

Brystnippel reduktion

AISI 316 - BSPT - LIGHT



Varenr.	BSPT	DKK
B10-2L	1/4" x 1/8"	16,85
B10-3L	3/8" x 1/4"	16,85
B10-4-1L	1/2" x 1/8"	19,25
B10-4-2L	1/2" x 1/4"	19,85
B10-4L	1/2" x 3/8"	20,50
B10-5-2L	3/4" x 1/4"	20,50
B10-5L	3/4" x 1/2"	30,00
B10-6-4L	1" x 1/2"	38,85
B10-6L	1" x 3/4"	41,95

Rørprop sekskant

AISI 316 - BSPT - LIGHT



Varenr.	BSPT	DKK
B12-1L	1/8"	16,10
B12-2L	1/4"	16,10
B12-3L	3/8"	16,85
B12-4L	1/2"	18,25
B12-5L	3/4"	22,85
B12-6L	1"	35,70

Union konisk nippel/muffe

AISI 316 - BSPT x BSPP - LIGHT



Varenr.	BSPP x BSPT	DKK
B8-1L	1/8"	58,45
B8-2L	1/4"	58,45
B8-3L	3/8"	67,70
B8-4L	1/2"	79,05
B8-5L	3/4"	115,50
B8-6L	1"	150,25

Slutmuffe sekskant

AISI 316 - BSPP - LIGHT



Varenr.	BSPP	DKK
B17-1L	1/8"	16,10
B17-2L	1/4"	16,10
B17-3L	3/8"	16,85
B17-4L	1/2"	20,55
B17-5L	3/4"	28,45
B17-6L	1"	39,95

Nippelmuffe

AISI 316 - BSPT x BSPP - LIGHT



Varenr.	BSPT x BSPP	DKK
B28-2L	1/4" x 1/8"	16,85
B28-3-1L	3/8" x 1/8"	18,25
B28-3L	3/8" x 1/4"	18,25
B28-4-1L	1/2" x 1/8"	18,25
B28-4-2L	1/2" x 1/4"	18,25
B28-4L	1/2" x 3/8"	18,25
B28-5-2L	3/4" x 1/4"	23,80
B28-5-3L	3/4" x 3/8"	22,90
B28-5L	3/4" x 1/2"	21,20
B28-6-4L	1" x 1/2"	36,45
B28-6L	1" x 3/4"	32,70

Kontramøtrik

AISI 316 - BSPP - LIGHT



Varenr.	BSPP	DKK
B15-1L	1/8"	16,10
B15-2L	1/4"	16,10
B15-3L	3/8"	16,10
B15-4L	1/2"	16,85
B15-5L	3/4"	19,75
B15-6L	1"	16,95

Union konisk muffe/muffe

AISI 316 - BSPP - LIGHT



Varenr.	BSPP	DKK
B6-1L	1/8"	54,85
B6-2L	1/4"	54,85
B6-3L	3/8"	62,75
B6-4L	1/2"	72,40
B6-5L	3/4"	115,50
B6-6L	1"	133,25

Union 90° konisk nip/muf

AISI 316 - BSPT×BSPP - LIGHT



Varenr.	BSPT×BSPP	DKK
B19-4L	1/2"	91,85
B19-5L	3/4"	132,50
B19-6L	1"	169,00

Union 90° konisk muf/muf

AISI 316 - BSPP - LIGHT



Varenr.	BSPP	DKK
B20-4L	1/2"	85,25
B20-5L	3/4"	121,25
B20-6L	1"	152,25

Svejsenippel

AISI 316 - BSPT - LIGHT



Varenr.	BSPT	L	DKK
B26-2-030L	1/4"	30mm	11,25
B26-3-030L	3/8"	30mm	13,00
B26-4-035L	1/2"	35mm	15,15
B26-5-040L	3/4"	40mm	20,35
B26-6-040L	1"	40mm	26,85

Nippelrør

AISI 316 - BSPT - LIGHT



Varenr.	BSPT	L	DKK
B25-2-040L	1/4"	40mm	14,75
B25-3-040L	3/8"	40mm	16,45
B25-4-040L	1/2"	40mm	15,15
B25-4-060L	1/2"	60mm	18,65
B25-4-070L	1/2"	70mm	20,35
B25-4-080L	1/2"	80mm	22,10
B25-4-090L	1/2"	90mm	23,80
B25-4-100L	1/2"	100mm	25,55
B25-4-110L	1/2"	110mm	27,30
B25-4-120L	1/2"	120mm	29,45
B25-4-130L	1/2"	130mm	30,75
B25-4-140L	1/2"	140mm	32,45
B25-4-150L	1/2"	150mm	34,20
B25-4-160L	1/2"	160mm	35,95
B25-5-040L	3/4"	40mm	18,20
B25-5-050L	3/4"	50mm	20,35
B25-5-060L	3/4"	60mm	22,50
B25-5-070L	3/4"	70mm	25,10
B25-5-080L	3/4"	80mm	27,30
B25-5-090L	3/4"	90mm	29,45
B25-5-100L	3/4"	100mm	32,05
B25-5-110L	3/4"	110mm	34,20
B25-5-120L	3/4"	120mm	36,80
B25-5-130L	3/4"	130mm	38,55
B25-5-140L	3/4"	140mm	41,10
B25-6-040L	1"	40mm	23,80
B25-6-050L	1"	50mm	26,85
B25-6-060L	1"	60mm	29,85
B25-6-070L	1"	70mm	33,35
B25-6-080L	1"	80mm	44,15
B25-6-090L	1"	90mm	38,95
B25-6-100L	1"	100mm	42,00
B25-6-110L	1"	110mm	45,00
B25-6-120L	1"	120mm	48,50
B25-6-130L	1"	130mm	51,50

Kuglehane 2-delt

AISI 316 - BSPP - FULD GENNEMLØB - LIGHT



Varenr.	BSPP	BAR	DKK
B33-2L	1/4"	63	115,50
B33-3L	3/8"	63	121,25
B33-4L	1/2"	63	136,50
B33-5L	3/4"	63	246,75
B33-6L	1"	63	279,25

Kuglehane muf/muf

AISI 316 - BSPP - REDUCERET GENNEMLØB - LIGHT



Varenr.	BSPP	BAR	DKK
B32-2L	1/4"	40	102,75
B32-3L	3/8"	40	102,75
B32-4L	1/2"	40	102,75
B32-5L	3/4"	40	142,25
B32-6L	1"	40	205,50

Kuglehane 3-delt

AISI 316 - BSPP - FULD GENNEMLØB - LIGHT



Varenr.	BSPP	BAR	DKK
B33-22L	1/4"	63	178,50
B33-23L	3/8"	63	178,50
B33-24L	1/2"	63	192,75
B33-25L	3/4"	63	292,50
B33-26L	1"	63	392,50

MUFFER & NIPPELRØR RUSTFRI AISI 316



Støbte muffer: max 15bar.
Resten: 20°C: 1" 250bar,
4" 140bar



-20° til +180°C



Ikke støbte kan leveres
med 3.1 certifikat

3.1 certifikat skal bestilles ved ordrefgi-
velse og koster et mindre tillæg.

Muffe sekskant

AISI 316 - BSPP



Varenr.	BSPP	DKK
B24-5NB	3/4"	34,90 ₺

₺ = så længe lager haves

Halvmuffe

AISI 316 - BSPP



Varenr.	BSPP	DKK
BC21-5	3/4"	11,90 ₺
BC21-8	1 1/2"	30,50 ₺
BC21-9	2"	42,40 ₺
BC21-10	2 1/2"	75,20 ₺
BC21-12	4"	162,50 ₺

₺ = så længe lager haves

Halvmuffe

AISI 316 - BSPP



Med chargenr, 3.1 certifikat muligt

Varenr.	BSPP	DKK
B21-1	1/8"	13,95
B21-2	1/4"	13,95
B21-3	3/8"	17,00
B21-4	1/2"	25,25
B21-5	3/4"	31,70
B21-6	1"	50,25
B21-7	1 1/4"	68,50
B21-8	1 1/2"	80,60
B21-9	2"	UDGÅET
B21-10	2 1/2"	198,50
B21-11	3"	255,50
B21-12	4"	427,50

Nippelrør gennemskåret

AISI 316 - BSPP



Varenr.	BSPP	L	DKK
B27-1-016	1/8"	16mm	33,05
B27-2-018	1/4"	18mm	15,85
B27-2-030	1/4"	30mm	26,45
B27-3-022	3/8"	22mm	19,00
B27-4-025	1/2"	25mm	23,20
B27-5-030	3/4"	30mm	29,95
B27-6-035	1"	35mm	43,60
B27-7-038	1 1/4"	38mm	58,15
B27-8-038	1 1/2"	38mm	64,95
B27-9-045	2"	45mm	103,50
B27-10-055	2 1/2"	55mm	172,25
B27-11-060	3"	60mm	282,25
B27-12-070	4"	70mm	459,00

Halvmuffe støbt

AISI 316 - BSPP



Varenr.	BSPP	DKK
B23-1	1/8"	14,45 ₺
B23-4	1/2"	16,75 ₺
B23-7	1 1/4"	39,35 ₺
B23-9	2"	71,00 ₺
B23-10	2 1/2"	176,50 ₺

₺ = så længe lager haves

Muffe

AISI 316 - BSPP



Varenr.	BSPP	DKK
BC22-12	4"	231,25 α

α = så længe lager havet

Nippelrør

AISI 304 - BSPT



Varenr.	BSPT	L	DKK
BC27-6-035-304	1"	35mm	4,27 α
BC25-8-040-304	1 1/2"	40mm	9,65 α
BC25-9-040-304	2"	40mm	10,95 α

α = så længe lager havet

Svejsenippel

AISI 316 - BSPT



Med chargin, 3.1 certifikat muligt

Varenr.	BSPT	L	DKK
B26-1-030	1/8"	30mm	17,65
B26-2-030	1/4"	30mm	16,40
B26-3-030	3/8"	30mm	19,65
B26-3-040	3/8"	40mm	21,40
B26-4-035	1/2"	35mm	25,55
B26-4-040	1/2"	40mm	27,20
B26-4-100	1/2"	100mm	68,25
B26-4-110	1/2"	110mm	71,80
B26-5-030	3/4"	30mm	27,90
B26-5-040	3/4"	40mm	33,10
B26-5-100	3/4"	100mm	82,75
B26-6-040	1"	40mm	44,50
B26-6-050	1"	50mm	49,10
B26-6-100	1"	100mm	98,30
B26-6-150	1"	150mm	147,25
B26-7-035	1 1/4"	35mm	88,60
B26-7-050	1 1/4"	50mm	66,10
B26-7-100	1 1/4"	100mm	121,25
B26-8-050	1 1/2"	50mm	73,15
B26-8-080	1 1/2"	80mm	118,00
B26-8-100	1 1/2"	100mm	146,50
B26-9-050	2"	50mm	105,25
B26-9-080	2"	80mm	126,00
B26-9-100	2"	100mm	134,50
B26-9-120	2"	120mm	161,25
B26-10-060	2 1/2"	60mm	164,75
B26-11-065	3"	65mm	271,00
B26-11-070	3"	70mm	311,25
B26-12-080	4"	80mm	327,75
B26-12-100	4"	100mm	559,25

Muffe

AISI 316 - BSPP



Med chargin, 3.1 certifikat muligt

Varenr.	BSPP	DKK
B22-1	1/8"	19,55
B22-2	1/4"	20,10
B22-3	3/8"	24,25
B22-4	1/2"	36,05
B22-5	3/4"	45,10
B22-6	1"	71,60
B22-7	1 1/4"	97,85
B22-8	1 1/2"	115,25
B22-9	2"	159,75
B22-10	2 1/2"	283,25
B22-11	3"	364,75
B22-12	4"	610,50

Nippelrør

AISI 316 - BSPT



Varenr.	BSPT	L	DKK
BC25-1-015s	1/8"	15mm	5,65 α
BC25-3-025s	3/8"	25mm	6,65 α
BC25-3-080	3/8"	80mm	12,15 α
BC25-5-040	3/4"	40mm	12,95 α
BC25-5-150	3/4"	150mm	29,95 α
BC25-9-040s	2"	40mm	36,55 α
BC25-9-060	2"	60mm	32,90 α
BC25-10-050	2 1/2"	50mm	55,75 α
BC25-10-060	2 1/2"	60mm	45,10 α
BC25-10-100	2 1/2"	100mm	77,25 α
BC25-10-150	2 1/2"	150mm	125,50 α
BC25-10-200	2 1/2"	200mm	136,50 α

α = så længe lager havet



Med chargenr, 3.1 certifikat muligt			
Varenr.	BSPT	L	DKK
B25-1-015s	1/8"	15mm	23,05 ☒
B25-1-025	1/8"	25mm	20,75
B25-1-030	1/8"	30mm	21,55
B25-1-040	1/8"	40mm	23,75
B25-1-060	1/8"	60mm	44,70
B25-1-100	1/8"	100mm	67,75
B25-2-018s	1/4"	18mm	43,90 ☒
B25-2-025s	1/4"	25mm	27,90
B25-2-025	1/4"	25mm	23,45
B25-2-030	1/4"	30mm	23,55
B25-2-040	1/4"	40mm	23,55
B25-2-050	1/4"	50mm	24,60
B25-2-060	1/4"	60mm	26,15
B25-2-080	1/4"	80mm	32,85
B25-2-100	1/4"	100mm	49,35
B25-3-025s	3/8"	25mm	28,15 ☒
B25-3-030	3/8"	30mm	25,50
B25-3-040	3/8"	40mm	24,85
B25-3-050	3/8"	50mm	27,90
B25-3-060	3/8"	60mm	31,85
B25-3-080	3/8"	80mm	38,10
B25-3-100	3/8"	100mm	40,85
B25-3-180	3/8"	180mm	49,35
B25-4-030s	1/2"	30mm	35,05 ☒
B25-4-040	1/2"	40mm	35,05
B25-4-050	1/2"	50mm	33,10
B25-4-060	1/2"	60mm	39,15
B25-4-075	1/2"	75mm	44,70
B25-4-080	1/2"	80mm	43,35
B25-4-100	1/2"	100mm	51,65
B25-4-120	1/2"	120mm	62,00
B25-4-150	1/2"	150mm	74,80

B25-4-200	1/2"	200mm	95,30
B25-4-250	1/2"	250mm	98,70
B25-5-030s	3/4"	30mm	40,55 ☒
B25-5-040	3/4"	40mm	40,55
B25-5-050	3/4"	50mm	42,05
B25-5-060	3/4"	60mm	48,00
B25-5-080	3/4"	80mm	53,55
B25-5-090	3/4"	90mm	58,75
B25-5-100	3/4"	100mm	63,90
B25-5-120	3/4"	120mm	73,15
B25-5-150	3/4"	150mm	93,90
B25-5-170	3/4"	170mm	103,50
B25-5-200	3/4"	200mm	112,25
B25-5-250	3/4"	250mm	129,50
B25-6-030s	1"	30mm	72,40 ☒
B25-6-034s	1"	34mm	72,40 ☒
B25-6-040	1"	40mm	49,95
B25-6-050	1"	50mm	52,95
B25-6-060	1"	60mm	59,25
B25-6-080	1"	80mm	73,15
B25-6-100	1"	100mm	86,80
B25-6-120	1"	120mm	107,75
B25-6-150	1"	150mm	122,00
B25-6-200	1"	200mm	155,50
B25-6-250	1"	250mm	160,25
B25-6-300	1"	300mm	174,00
B25-7-040s	1 1/4"	40mm	61,70 ☒
B25-7-050	1 1/4"	50mm	71,80
B25-7-060	1 1/4"	60mm	82,50
B25-7-080	1 1/4"	80mm	93,10
B25-7-150	1 1/4"	150mm	155,50
B25-7-200	1 1/4"	200mm	199,75
B25-7-250	1 1/4"	250mm	219,50
B25-8-040s	1 1/2"	40mm	110,75 ☒

B25-8-050	1 1/2"	50mm	94,20
B25-8-080	1 1/2"	80mm	103,50
B25-8-120	1 1/2"	120mm	143,50
B25-8-150	1 1/2"	150mm	185,50
B25-8-180	1 1/2"	180mm	204,25
B25-8-200	1 1/2"	200mm	222,75
B25-8-250	1 1/2"	250mm	234,25
B25-9-040s	2"	40mm	114,75 ☒
B25-9-050	2"	50mm	149,75
B25-9-060	2"	60mm	177,00
B25-9-080	2"	80mm	204,25
B25-9-100	2"	100mm	220,75
B25-9-120	2"	120mm	271,75
B25-9-200	2"	200mm	322,75
B25-9-250	2"	250mm	338,75
B25-10-050	2 1/2"	50mm	141,50
B25-10-060	2 1/2"	60mm	174,75
B25-10-100	2 1/2"	100mm	242,25
B25-10-150	2 1/2"	150mm	334,75
B25-10-200	2 1/2"	200mm	427,50
B25-11-060	3"	60mm	265,75
B25-11-080	3"	80mm	334,00
B25-11-120	3"	120mm	467,75
B25-11-150	3"	150mm	569,00
B25-11-200	3"	200mm	737,75
B25-11-260	3"	260mm	1024,25
B25-12-080	4"	80mm	467,75
B25-12-100	4"	100mm	565,00
B25-12-120	4"	120mm	659,50
B25-12-150	4"	150mm	803,50
B25-12-200	4"	200mm	1043,50

☒ = sammenskåret

NPT FITTINGS RUSTFRI AISI 316



Max 10bar



-20°C til +400°C



NPT gevind er en amerikansk standard, som typisk kun finder anvendelse i forbindelse med amerikansk udstyr eller maskiner.

Bemærk, at der ved muffer er tale om NPS (cylindrisk) gevind i vores fittings.

Vinkel 90° muf/muf

AISI 316 - NPT



Varenr.	NPT	DKK
B1-2NPT	1/4"	63,65
B1-3NPT	3/8"	70,75
B1-4NPT	1/2"	96,65
B1-5NPT	3/4"	156,50
B1-6NPT	1"	243,50

Vinkel 90° muffe/nippel

AISI 316 - NPT



Varenr.	NPT	DKK
B4-2NPT	1/4"	74,80
B4-3NPT	3/8"	85,20
B4-4NPT	1/2"	101,25
B4-5NPT	3/4"	159,00
B4-6NPT	1"	262,50

Rørprop

AISI 316 - NPT



Varenr.	NPT	DKK
B12-2NPT	1/4"	36,90
B12-3NPT	3/8"	42,75
B12-4NPT	1/2"	72,90
B12-5NPT	3/4"	68,85
B12-6NPT	1"	97,20

T-stk m. muffer

AISI 316 - NPT



Varenr.	NPT	DKK
B2-2NPT	1/4"	78,90
B2-3NPT	3/8"	102,25
B2-4NPT	1/2"	143,50
B2-5NPT	3/4"	218,00
B2-6NPT	1"	336,75

Brystnippel

AISI 316 - NPT



Varenr.	NPT	DKK
B9-2NPT	1/4"	49,85
B9-3NPT	3/8"	59,25
B9-4NPT	1/2"	72,90
B9-5NPT	3/4"	97,20
B9-6NPT	1"	159,00

Slangenippel

AISI 316 - NPT



Varenr.	Ø × NPT	DKK
B14-2NPT	6 × 1/4"	85,20
B14-3NPT	10 × 3/8"	102,25
B14-4NPT	13 × 1/2"	95,55
B14-5NPT	19 × 3/4"	188,50
B14-6NPT	25 × 1"	261,00
B14-7NPT	32 × 1 1/4"	247,00
B14-8NPT	39 × 1 1/2"	303,50
B14-9NPT	51 × 2"	503,00

Nippelmuffe

AISI 316 - NPT



Varenr.	NPT	DKK
B28-2NPT	1/4" × 1/8"	57,35
B28-3NPT	3/8" × 1/4"	57,35
B28-4-1NPT	1/2" × 1/8"	64,45
B28-4NPT	1/2" × 3/8"	64,45
B28-4-2NPT	1/2" × 1/4"	54,35
B28-5NPT	3/4" × 1/2"	64,45
B28-6NPT	1" × 3/4"	64,45

Nippelmuffe

AISI 316 - NPT×BSPP

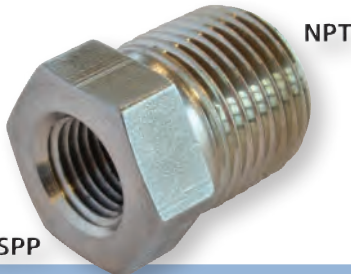

BSPP			
Varenr.	NPT × BSPP	bar	DKK
B47-3	1/4" × 1/4"	400	406,00
B47-6	1/4" × 1/2"	400	406,00
B47-4	3/8" × 1/4"	400	406,00
B47-7	3/8" × 1/2"	400	406,00
B47-8	1/2" × 1/2"	400	406,00
B47-9	3/4" × 1/2"	400	547,00

Muffe

AISI 316 - NPT



Varenr.	NPT	DKK
B22-2NPT	1/4"	28,70
B22-3NPT	3/8"	32,85
B22-4NPT	1/2"	43,00
B22-5NPT	3/4"	193,75
B22-6NPT	1"	122,00

Muffe

AISI 316 - NPT



Varenr.	NPT	L	DKK
BC22-4NPT-50	1/2"	50	12,20 ₪

₪ = så længe lager haves

Brystnippel højtryk

AISI 316 - BSPP×NPT



60° konus i BSPP-enden			
Varenr.	BSPP × NPT	bar	DKK
CP84-1	1/8"	400	143,00
CP84-2	1/4"	400	128,00
CP84-3	3/8"	400	154,50
CP84-4	1/2"	400	171,50
CP84-5	3/4"	400	233,75
CP84-6	1"	400	363,25
CP84-7	1 1/4"	200	674,00
CP84-8	1 1/2"	200	743,50
CP84-9	2"	100	1094,00

Brystnippel højtryk

AISI 316 - NPT



Varenr.	NPT	bar	DKK
CP85-2	1/4"	630	116,50
CP85-3	3/8"	630	161,75
CP85-4	1/2"	630	184,75
CP85-5	3/4"	630	251,75
CP85-6	1"	400	358,50
CP85-7	1 1/4"	400	694,50
CP85-8	1 1/2"	400	905,00
CP85-9	2"	315	1195,00

Brystnippel højtryk red.

AISI 316 - BSPP×NPT



60° konus i BSPP-enden			
Varenr.	BSPP × NPT	bar	DKK
CP132-1-2	1/8" × 1/4"	400	182,50
CP132-2-1	1/4" × 1/8"	400	182,50
CP132-2-3	1/4" × 3/8"	400	153,50
CP132-2-4	1/4" × 1/2"	400	209,00
CP132-3-2	3/8" × 1/4"	400	184,75
CP132-3-4	3/8" × 1/2"	400	187,00
CP132-3-5	3/8" × 3/4"	400	336,75
CP132-4-3	1/2" × 3/8"	400	199,50
CP132-4-5	1/2" × 3/4"	400	328,00
CP132-4s-5	5/8" × 3/4"	400	328,00
CP132-5-2	3/4" × 1/4"	400	355,00
CP132-5-3	3/4" × 3/8"	400	285,75
CP132-5-4	3/4" × 1/2"	400	340,25
CP132-5-6	3/4" × 1"	400	438,75
CP132-5-7	3/4" × 1 1/4"	200	₪
CP132-5-8	3/4" × 1 1/2"	200	1244,25
CP132-6-5	1" × 3/4"	400	502,25
CP132-6-7	1" × 1 1/4"	200	782,50
CP132-7-6	1 1/4" × 1"	200	828,75
CP132-7-8	1 1/4" × 1 1/2"	200	1142,50
CP132-8-7	1 1/2" × 1 1/4"	200	1072,25
CP132-8-9	1 1/2" × 2"	100	1519,25
CP132-9-8	2" × 1 1/2"	100	991,50

₪ = spørg på pris

Adapter

MESSING - BSPP×NPT



Varenr.	BSPP×NPT	bar	DKK
E74-1	1/8"	150	17,00
E74-2	1/4"	100	20,15
E74-3	3/8"	75	47,30

Adapter

MESSING - NPT×BSPP



Varenr.	NPT×BSPP	bar	DKK
E75-1	1/8"	150	11,40
E75-2	1/4"	100	23,85
E75-3	3/8"	75	44,10
E75-4	1/2"	50	59,25

Union kon nippel/muffe

AISI 316 - NPT



Varenr.	NPT	DKK
B8-2NPT	1/4"	171,50
B8-3NPT	3/8"	196,50
B8-4NPT	1/2"	231,50
B8-5NPT	3/4"	297,00
B8-6NPT	1"	386,75
B8-7NPT	1 1/4"	544,00
B8-8NPT	1 1/2"	697,25

FLANGER RUSTFRI/ALU



PN10/16



DIN norm



Kan leveres med 3.1 certifikat

Rustfri syrefaste 316L flanger, DIN dimensioner. Størrelser fra 10,2 til 219,1mm samt gevindflanger fra 1/8" til 8" lagres.

Alle flangepriser = dagspriser!

Gevindflange type 13

AISI 316 - BSPP

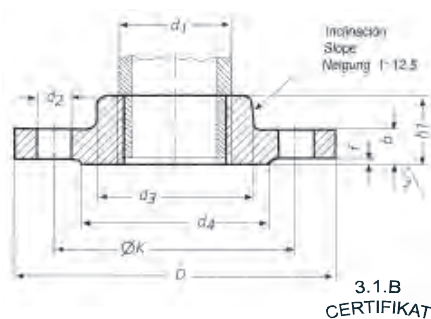

Varenr.	dim	D	ØK	Bolthuller	DKK
F256606	6 1/8"	75	50	4	☒
F256610	10 3/8"	90	60	4	603,00
F256615	15 1/2"	95	65	4	229,25
F256620	20 3/4"	105	75	4	311,25
F256625	25 1"	115	85	4	413,00
F256632	32 1 1/4"	140	100	4	433,50
F256640	40 1 1/2"	150	110	4	668,25
F256650	50 2"	165	125	4	773,25
F256665	65 2 1/2"	185	145	4	976,25
F256680	80 3"	200	160	8	1266,00
F2566100	100 4"	220	180	8	1371,00
F2566125	125 5"	250	210	8	☒

☒ = spørg på pris

ND10/16		FLANGE					BOLT	
Varenr.	mm	b	h1	d3	d4	f	d2	kg
F256606	10,2	12	18	20	32	2	M10 11	0,33
F256610	17,2	14	20	30	40	2	M12 14	0,54
F256615	21,3	14	20	35	45	2	M12 14	0,61
F256620	26,9	16	24	45	58	2	M12 14	0,91
F256625	33,7	16	24	52	68	2	M12 14	1,10
F256632	42,4	16	26	60	78	2	M16 18	1,60
F256640	48,3	16	26	70	88	3	M16 18	1,78
F256650	60,3	18	28	85	102	3	M16 18	2,43
F256665	76,1	18	32	105	122	3	M16 18	3,18
F256680	88,9	20	34	118	138	3	M16 18	4,12
F2566100	114,3	20	38	140	158	3	M16 18	4,47
F2566125	139,7	22	40	168	188	3	M16 18	6,13
F2566150	168,3	22	44	195	212	3	M20 22	7,92

Blindflange type 05

AISI 316

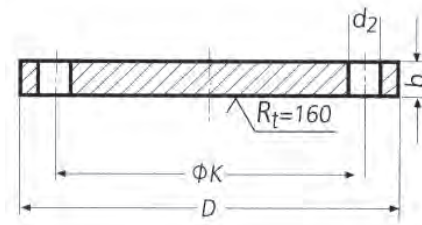

3.1.B
CERTIFIKAT

Varenr.	dim	D	ØK	Bolthuller	DKK
F252710	10	90	60	4	145,25
F252715	15	95	65	4	196,00
F252720	20	105	75	4	208,50
F252725	25	115	85	4	284,25
F252732	32	140	100	4	490,00
F252740	40	150	110	4	627,00
F252750	50	165	125	4	587,50
F252765	65	185	145	4	967,50
F252780	80	200	160	8	1201,00
F2527100	100	220	180	8	1422,50
F2527125	125	250	210	8	1651,25
F2527150	150	285	240	8	2096,25
F2527200	200	340	295	8	4711,25
F2527250	250	395	350	12	4935,00

α = spørg på pris

ND10		FLANGE	BOLT	
Varenr.	Dim	b	d2	kg
F252710	10	14	M12 14	0,63
F252715	15	14	M12 14	0,72
F252720	20	16	M12 14	1,01
F252725	25	16	M12 14	1,23
F252732	32	16	M16 18	1,80
F252740	40	16	M16 18	2,09
F252750	50	18	M16 18	2,88
F252765	65	18	M16 18	3,66
F252780	80	20	M16 18	4,77
F2527100	100	20	M16 18	4,65
F2527125	125	22	M16 18	8,42
F2527150	150	22	M20 22	10,40
F2527200	200	24	M20 22	16,50
F2527250	250	26	M20 22	24,00

Glatflange type 01

AISI 316

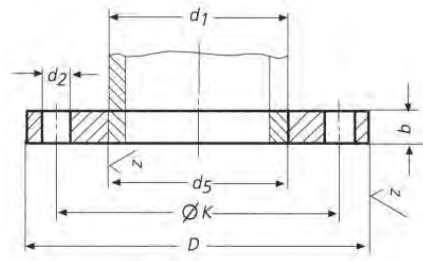

3.1.B
CERTIFIKAT

Varenr.	dim	d1	D	ØK	Bolthuller	DKK
F257610	10	17,2	90	60	4	156,25
F257615	15	21,3	95	65	4	182,50
F257620	20	26,9	105	75	4	181,50
F257625	25	33,7	115	85	4	306,75
F257632	32	42,4	140	100	4	441,25
F257640	40	48,3	150	110	4	478,25
F257650	50	60,3	165	125	4	661,75
F257665	65	76,1	185	145	4	875,50
F257680	80	88,9	200	160	8	709,75
F2576100	100	114,3	220	180	8	864,75
F2576125	125	139,7	250	210	8	1443,25
F2576150	150	168,3	285	240	8	α
F2576200	200	219,1	340	295	8	1741,75
F2576250	250	273,0	395	350	12	3144,75
F2576300	300	323,9	445	400	12	3646,25
F2576400	400	406,4	565	515	16	7587,00
F2576450	450	457,0	615	565	20	10058,00
F2576500	500	508,0	670	620	20	11500,00

α = spørg på pris

Varenr.	ND10		FLANGE		BOLT	
	d5	b	e	d2	kg	
F257610	17,7	14	5	M12 14	0,61	
F257615	22,0	14	5	M12 14	0,67	
F257620	27,6	16	5	M12 14	0,94	
F257625	34,4	16	5	M12 14	1,11	
F257632	43,1	16	5	M16 18	1,62	
F257640	49,0	16	5	M16 18	1,86	
F257650	61,1	18	6	M16 18	2,47	
F257665	77,1	18	6	M16 18	3,00	
F257680	90,3	20	7	M16 18	3,79	
F2576100	115,9	20	7	M16 18	4,03	
F2576125	141,6	22	7	M16 18	5,46	
F2576150	170,5	22	7	M20 22	6,57	
F2576200	221,8	24	7	M20 22	9,31	
F2576250	276,2	26	7	M20 22	11,9	
F2576300	327,6	26	7	M20 22	13,8	
F2576400	411,0	32	7	M24 26	27,9	
F2576500	462,5	38	7	M24 26	35,6	

Svejsseflange type 11

AISI 316

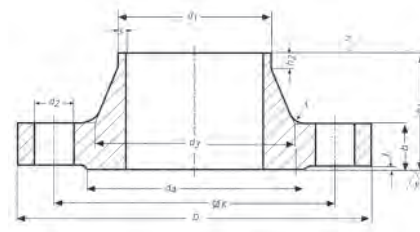

3.1.B
CERTIFIKAT

Varenr.	dim	d1	D	ØK	BolthullerDKK	
F263310	10	17,2	90	60	4	231,50
F263315	15	21,3	95	65	4	199,00
F263320	20	26,9	105	75	4	360,25
F263325	25	33,7	115	85	4	348,50
F263332	32	42,4	140	100	4	624,50
F263340	40	48,3	150	110	4	390,00
F263350	50	60,3	165	125	4	540,50
F263365	65	76,1	185	145	4	981,75
F263380	80	88,9	200	160	8	834,25
F2633100	100	114,3	220	180	8	1351,50
F2633125	125	139,7	250	210	8	1936,50
F2633150	150	168,3	285	240	8	1701,75
F2633200	200	219,1	340	295	12	3382,75
F2633250	250	273,0	405	355	12	4796,75
F2633300	300	323,9	460	410	12	4998,75
F2633400	400	406,4	580	525	16	α
F2633500	500	508,0	715	650	20	α

α = spørg på pris

ND16	FLANGE						BOLT	
Varenr.	b	h1	d3	s	h2	f	d2	kg
F263310	14	35	28	1,8	6	2	M12 14	0,58
F263315	14	35	32	2,0	6	2	M12 14	0,65
F263320	16	38	40	2,3	6	2	M12 14	0,95
F263325	16	38	45	2,6	6	2	M14 14	1,14
F263332	16	40	56	2,6	6	2	M16 18	1,69
F263340	16	42	64	2,6	7	3	M16 18	1,86
F263350	18	45	75	2,9	8	3	M16 18	2,53
F263365	18	45	90	2,9	10	3	M16 18	3,06
F263380	20	50	105	3,2	10	3	M16 18	3,70
F2633100	20	52	131	3,6	12	3	M16 18	4,62
F2633125	22	55	156	4,0	12	3	M16 18	6,30
F2633150	22	55	184	4,5	12	3	M20 22	7,75
F2633200	24	62	235	5,9	16	3	M20 22	11,00
F2633250	26	70	292	6,3	16	3	M24 26	15,60
F2633300	28	78	344	7,1	16	4	M24 26	22,00
F2633400	32	85	445	8,0	16	4	M27 30	39,30
F2633500	34	90	548	8,0	16	4	M30 33	61,00

Løsflange type 02

AISI 316



D

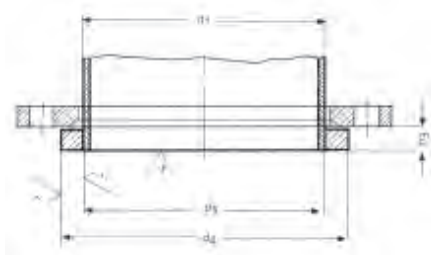

3.1.B
CERTIFIKAT

Presset flange PN10

AISI 316



Denne type flanger har samme styrke som massive flanger, men med en meget lavere vægt og deraf også lavere pris.

Varenr.	dim	d1	D	ØK	Bolthuller	DKK
F264210	10	17,2	90	60	4	164,00
F264215	15	21,3	95	65	4	189,25
F264220	20	26,9	105	75	4	407,50
F264225	25	33,7	115	85	4	303,75
F264232	32	42,4	140	100	4	447,75
F264240	40	48,3	150	110	4	473,00
F264250	50	60,3	165	125	4	600,50
F264265	65	76,1	185	145	4	765,50
F264280	80	88,9	200	160	8	878,00
F2642100	100	114,3	220	180	8	970,75
F2642125	125	139,7	250	210	8	1202,25
F2642150	150	168,3	285	240	8	1611,00
F2642200	200	219,1	340	295	8	2608,00
F2642250	250	273,0	395	273	12	2727,50
F2642300	300	323,9	445	400	12	3707,00
F2642400	400	406,4	565	515	16	6816,75
F2642500	500	508,0	670	620	20	9883,00

α = spørg på pris

ND10		FLANGE			BOLT	
Varenr.	Dim	d6	b	e	d2	kg
F264210	10	19	14	3	M12 14	0,60
F264215	15	24	14	3	M12 14	0,69
F264220	20	30	14	3	M12 14	0,81
F264225	25	36	16	4	M12 14	1,11
F264232	32	46	16	4	M16 18	1,64
F264240	40	54	16	4	M16 18	1,86
F264250	50	65	16	5	M16 18	2,20
F264265	65	81	16	5	M16 18	2,62
F264280	80	94	18	5	M16 18	3,32
F2642100	100	119	18	5	M16 18	3,67
F2642125	125	145	18	5	M16 18	4,54
F2642150	150	173	18	5	M20 22	5,60
F2642200	200	225	20	5	M20 22	7,46
F2642250	250	279	22	5	M20 22	10,30
F2642300	300	329	26	5	M20 22	14,00
F2642400	400	413	32	6	M24 26	25,00
F2642500	500	517	38	6	M24 26	37,00

Varenr.	dim	DKK
PF264215	DN15	113,00
PF264220	DN20	121,25
PF264225	DN25	131,25
PF264232	DN32	174,75
PF264240	DN40	274,50
PF264250	DN50	282,25
PF264265	DN65	327,50
PF264280	DN80	431,25
PF2642100	DN100	468,00
PF2642125	DN125	832,25
PF2642150	DN150	936,25
PF2642200	DN200	1582,25
PF2642250	DN250	2350,50
PF2642300	DN300	2711,00

Løsflange DIN 2642 ALUMINIUM

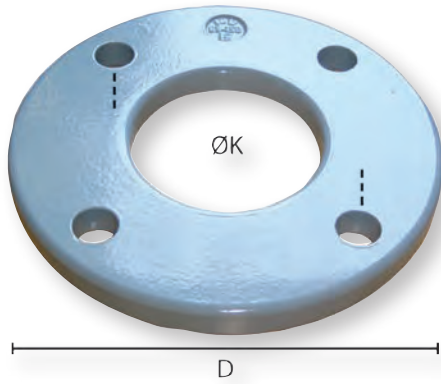

Coated

Varenr.	Dim d1	D ØK	BolthullerDKK
AFNV264210-COAT	10 17,2	90 60	4 64,40
AFNV264215-COAT	15 21,3	95 65	4 64,40
AFNV264220-COAT	20 26,9	105 75	4 64,40
AFNV264225-COAT	25 33,7	115 85	4 70,05
AFNV264232-COAT	32 42,4	140 100	4 107,25
AFNV264240-COAT	40 48,3	150 110	4 110,25
AFNV264250-COAT	50 60,3	165 125	4 125,25
AFNV264265-COAT	65 76,1	185 145	4 202,00
AFNV264280-COAT	80 88,9	200 160	8 204,00
AFNV2642100-COAT	100 114,3	220 180	8 261,75
AFNV2642125-COAT	125 139,7	250 210	8 50,00
AFNV2642150-COAT	150 168,3	285 240	8 396,75
AFNV2642200-COAT	200 219,1	340 295	8 511,00
AFNV2642250-COAT	250 273,0	395 350	12 572,25
AFNV2642300-COAT	300 323,9	445 400	12 739,75
AFNV2642400-COAT	400 406,4	565 515	16 1476,75
AFNV2642500-COAT	500 508,0	670 620	20 2151,75

α = spørg på pris

Løsflange DIN 2642 ALUMINIUM

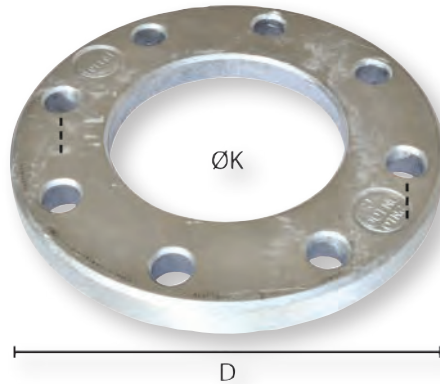

Ikke coated

Varenr.	Dim d1	D ØK	Bolthuller DKK
AFNV264210	10 17,2	90 60	4 48,95
AFNV264215	15 21,3	95 65	4 41,20
AFNV264220	20 26,9	105 75	4 45,35
AFNV264225	25 33,7	115 85	4 58,20
AFNV264232	32 42,4	140 100	4 103,00
AFNV264240	40 48,3	150 110	4 123,75
AFNV264250	50 60,3	165 125	4 136,00
AFNV264265	65 76,1	185 145	4 202,00
AFNV264280	80 88,9	200 160	8 205,00
AFNV2642100	100 114,3	220 180	8 251,50
AFNV2642125	125 139,7	250 210	8 250,50
AFNV2642150	150 168,3	285 240	8 362,75
AFNV2642200	200 219,1	340 295	8 383,75
AFNV2642250	250 273,0	395 350	12 515,00
AFNV2642300	300 323,9	445 400	12 639,75
AFNV2642400	400 406,4	565 515	16 1214,00
AFNV2642500	500 508,0	670 620	20 1960,25

α = spørg på pris

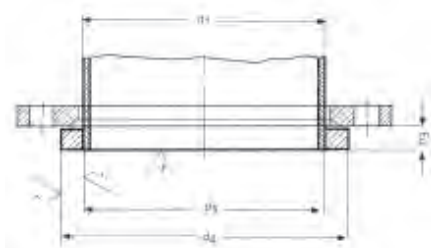

Varenr.	Dim	ND10 FLANGE			BOLT		kg
		d6	b	e	d2		
AFNV264210	10	19	14	3	M12 14	0,22	
AFNV264215	15	24	14	3	M12 14	0,25	
AFNV264220	20	30	14	3	M12 14	0,29	
AFNV264225	25	36	16	4	M12 14	0,40	
AFNV264232	32	46	16	4	M16 18	0,59	
AFNV264240	40	54	16	4	M16 18	0,68	
AFNV264250	50	65	16	5	M16 18	0,74	
AFNV264265	65	81	16	5	M16 18	0,79	
AFNV264280	80	94	18	5	M16 18	1,20	
AFNV2642100	100	119	18	5	M16 18	1,32	
AFNV2642125	125	145	18	5	M16 18	1,63	
AFNV2642150	150	173	18	5	M20 22	2,02	
AFNV2642200	200	225	20	5	M20 22	2,69	
AFNV2642250	250	279	22	5	M20 22	3,71	
AFNV2642300	300	329	26	5	M20 22	5,04	
AFNV2642400	400	413	32	6	M24 26	9,00	
AFNV2642500	500	517	38	6	M24 26	13,32	

Flangepakning 1,5mm PULP



Højtrykspade, asbestfri

Varenr.	DN	ø	DKK
000685018	10	18	5,95
000685021	15	22	6,80
000685027	20	28	5,85
000685034	25	35	7,15
000685042	32	43	8,40
000685048	40	49	9,60
000685060	50	61	13,45
000685076	65	77	16,45
000685089	80	90	19,55
000685114	100	115	23,75
000685133	125	133	31,00 α
000685139	125	141	31,00
000685168	150	169	40,25
000685219	200	220	57,60
000685273	250	274	82,15
000685324	300	325	106,50
000685368	350	368	139,75
000685420	400	420	172,25
000685462	450	462	209,50
000685520	500	520	246,50
000685620	600	620	403,00

α = så længe lager haves

FLANGER PVC



Max 16 bar



-20°C til +25°C, dog ved <4 bar: 60°C



U-PVC er i bund og grund et af de bedste plast produkter, der anvendes til rør installationer.

U-PVC har mange gode egenskaber.

Brandhæmmende, høj mekanisk styrke, god elektrisk isolations evne. Den er modstandsdygtighed over for kemikalier og slid, er smagløs og lugter mindre, som gør den ideel til brug med drikkevand.

Både fittings og rør er lette i vægt og fremstillet glatte, hvilket giver et fremragende flow, som mindsker bundfald og oplagring af snavs.

U-PVC fittings kan anvendes indenfor landbrug, vanding, vandværker, kemiske installationer, vandbehandling og i swimmingpools.

U-PVC overholder gældende normer i Scandinavien, Tyskland, Holland, England, Frankrig og Italien, og kan anvendes sammen med rør fremstillet efter samme international standarder.

Standarder limfittings: ISO 727, DIN 8063, KIWA BRL-K 17301, EN ISO 1452
Standarder gevind fittings: ISO 7/1, DIN 2999, BS 21, UNI ISO 228/1.

Løsflange DIN 8063

U-PVC (POLYVINYLCHLORID)



Varenr.	DN	dim	DKK
AF8063-20	15	20mm	21,15
AF8063-25	20	25mm	22,95
AF8063-32	25	32mm	26,55
AF8063-40	32	40mm	36,90
AF8063-50	40	50mm	41,10
AF8063-63	50	63mm	47,55
AF8063-75	65	75mm	61,70
AF8063-90	80	90mm	73,15
AF8063-110	100	110mm	86,80
AF8063-125	110	125mm	114,25
AF8063-140	125	140mm	130,25
AF8063-160	150	160mm	163,75
AF8063-200	200	200mm	323,75
AF8063-225	200	225mm	346,50
AF8063-250	225	250mm	362,25
AF8063-280	250	280mm	694,00
AF8063-315	300	315mm	771,50

Løsflange sæt DIN 8063

U-PVC (POLYVINYLCHLORID)

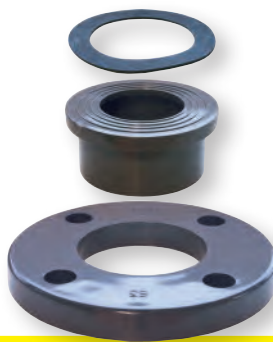

Flange+pakning+bøsning			
Varenr.	DN	dim	DKK
SAF8063-20	15	20	33,35
SAF8063-25	20	25	35,75
SAF8063-32	25	32	40,70
SAF8063-40	32	40	60,50
SAF8063-50	40	50	72,50
SAF8063-63	50	63	95,30
SAF8063-75	65	75	132,75
SAF8063-90	80	90	152,00
SAF8063-110	100	110	223,00
SAF8063-125	110	125	385,75
SAF8063-140	125	140	456,50
SAF8063-160	150	160	567,25
SAF8063-200	200	200	845,75
SAF8063-225	200	225	914,75
SAF8063-250	225	250	1408,25
SAF8063-280	250	280	2289,75
SAF8063-315	300	315	2373,25

Blindflange DIN 8063

U-PVC (POLYVINYLCHLORID)



Varenr.	DN	dim	DKK
AFB8063-20	15	20mm	25,55
AFB8063-25	20	25mm	28,40
AFB8063-32	25	32mm	38,30
AFB8063-40	32	40mm	49,50
AFB8063-50	40	50mm	60,35
AFB8063-63	50	63mm	74,55
AFB8063-75	65	75mm	98,85
AFB8063-90	80	90mm	115,50
AFB8063-110	100	110mm	149,25
AFB8063-125	110	125mm	173,25
AFB8063-140	125	140mm	204,75
AFB8063-160	150	160mm	228,50
AFB8063-200	200	200mm	441,50
AFB8063-225	200	225mm	455,75

Flange med krave

U-PVC (POLYVINYLCHLORID)



Varenr.	DN	dim	DKK
AFL2633-20	15	20mm	24,35
AFL2633-25	20	25mm	31,55
AFL2633-32	25	32mm	37,70
AFL2633-40	32	40mm	48,75
AFL2633-50	40	50mm	57,90
AFL2633-63	50	63mm	73,15
AFL2633-75	65	75mm	90,90
AFL2633-90	80	90mm	113,25
AFL2633-110	100	110mm	148,25

Gevindflange med krave

U-PVC (POLYVINYLCHLORID) - BSPP



Varenr.	BSPP	DKK
AFR2633-15	1/2"	40,20
AFR2633-20	3/4"	45,05
AFR2633-25	1"	57,35
AFR2633-32	1 1/4"	82,75
AFR2633-40	1 1/2"	110,00
AFR2633-50	2"	138,50
AFR2633-65	2 1/2"	178,25
AFR2633-80	3"	217,75
AFR2633-100	4"	263,75

REPARATIONSMUFFER RUSTFRI AISI 316



3/4" - 2": 16bar,
2 1/2" - 5": 14 bar, 6": 12 bar,
8" - 10": 8bar, 12": 7bar



-30°C til +110°C



BVQI-NO.56427 CE MARK

Bandagemuffer i 3 typer: GRIP, REPARATION samt VINKEL.



Bandagemuffe GRIP trækfast AISI 316 / EPDM



Max 16 bar

Varenr.	dim	ø	L	DKK
BJ1-2	3/4"	26,7-27,7	60mm	483,75
BJ1-3	1"	33,0-34,6	60mm	649,25
BJ1-4	1 1/4"	41,9-43,0	60mm	718,25
BJ1-5	1 1/2"	47,8-49,0	60mm	587,50
BJ1-6	2"	59,7-61,0	80mm	872,50
BJ1-7	2 1/2"	75,3-76,9	80mm	1007,75
BJ1-8	3"	88,0-90,0	110mm	1508,00
BJ1-9	4"	113,2-115,4	110mm	1657,50
BJ1-10	6"	166,6-170,0	111mm	2400,00
BJ1-11	8"	214,5-218,3	150mm	3573,25
BJ1-12	10"	264,8-270,0	150mm	4319,00

⊠ = max 10bar

Bandagemuffe REPAIR AISI 316 / EPDM



Max 16 bar

Varenr.	dim	ø	L	DKK
BJ2-1	1/2"	21,3-21,8	60mm	424,25
BJ2-2	3/4"	26,7-27,7	60mm	460,00
BJ2-3	1"	33,0-34,6	60mm	501,25
BJ2-4	1 1/4"	41,9-43,0	60mm	548,25
BJ2-5	1 1/2"	47,8-49,0	60mm	587,50
BJ2-6	2"	59,7-61,0	80mm	872,50
BJ2-7	2 1/2"	75,3-76,9	80mm	1007,75
BJ2-8	3"	88,0-90,0	110mm	1508,00
BJ2-9	4"	113,2-115,4	110mm	1657,50
BJ2-10	6"	166,6-170,0	111mm	2400,00
BJ2-11	8"	214,5-218,3	150mm	3618,50
BJ2-12	10"	264,8-270,0	150mm	4364,25

⊠ = max 10bar

Bandagemuffe ELBOW AISI 316 / EPDM



Max 16 bar

Varenr.	dim	ø	L	DKK
BJ3-1	1/2"	21,3-21,8	27mm	361,00
BJ3-2	3/4"	26,7-27,7	27mm	395,75
BJ3-3	1"	33,0-34,6	27mm	413,50
BJ3-4	1 1/4"	41,9-43,0	27mm	424,75
BJ3-5	1 1/2"	47,8-49,0	27mm	442,50
BJ3-6	2"	59,7-61,0	40mm	715,75
BJ3-7	2 1/2"	75,3-76,9	40mm	837,75
BJ3-8	3"	88,0-90,0	60mm	1256,75
BJ3-9	4"	113,2-115,4	60mm	1397,75
BJ3-10	6"	166,6-170,0	60mm	2010,75
BJ3-11	8"	214,5-218,3	60mm	3034,50
BJ3-12	10"	264,8-270,0	60mm	3612,25

⊠ = max 10bar

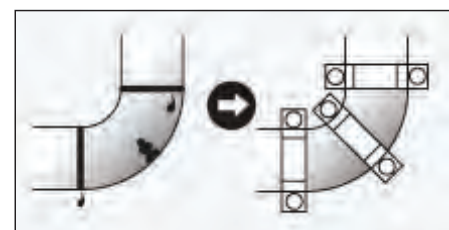
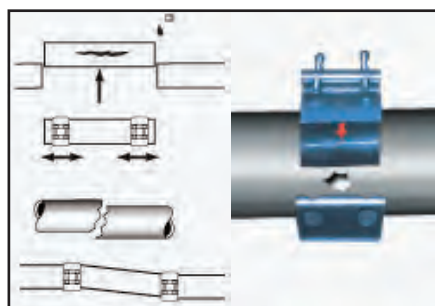
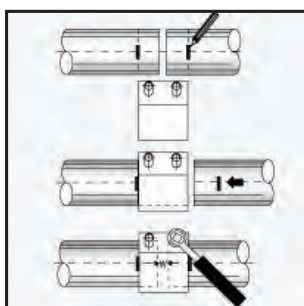

SKÆRERINGSFITTINGS RUSTFRI AISI 316



-26°C til +400°C iflg.
DIN 17 440, AD W 10



DIN 2353



Mulighed for 2.2/3.1
certifikat

Tolerancen i skemaet er + - 10%.

VIGTIGT:

Udvendigt gevind skal smøres med anbefalet fedt inden montering.

Værdierne i skemaet gælder kun for cylindriske gevind (BSPP), der er lavet af rustfri syrefast materiale 1.4571 ~ AISI 316.

Data gælder ikke for banjokoblinger WHV/THV og heller ikke for konisk gevind BSPT/NPT. Til adaptere og andre fittings med udvendigt BSPP gevind, skal tilspænding fra serie S bruges.

Serie	Rør	BSPP	MA (Nm)	Metrisk ISO gevind	MA (Nm)
L	6	1/8"	30	M 12 x 1,5	30
L	8	1/4"	60	M 14 x 1,5	35
L	10	1/4"	60	M 16 x 1,5	60
L	12	3/8"	95	M 18 x 1,5	95
L	15	1/2"	190	M 22 x 1,5	110
L	18	1/2"	130	M 26 x 1,5	190
L	22	3/4"	265	M 30 x 2	340
L	28	1"	445	M 36 x 2	510
L	35	1 1/4"	720	M 45 x 2	720
L	42	1 1/2"	960	M 52 x 2	960
S	6	1/4"	75	M 14 x 1,5	45
S	8	1/4"	75	M 16 x 1,5	75
S	10	3/8"	135	M 18 x 1,5	115
S	12	3/8"	135	M 20 x 1,5	145
S	14	1/2"	205	M 22 x 1,5	205
S	16	1/2"	170	M 24 x 1,5	230
S	20	3/4"	385	M 30 x 2	385
S	25	1"	460	M 36 x 2	600
S	30	1 1/4"	720	M 42 x 2	720
S	38	1 1/2"	960	M 52 x 2	960

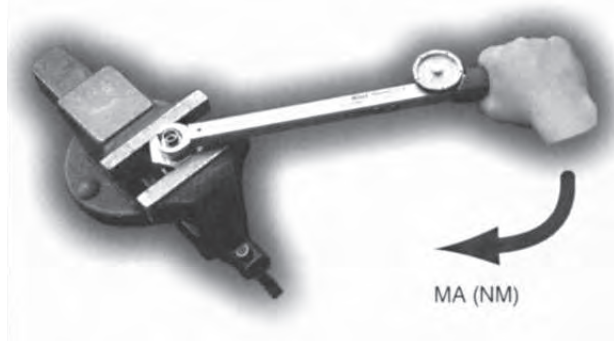

RUSTFRI FITTINGS



FOR DIN EGEN SIKKERHEDS SKYLD!



Det er vigtigt, at du kun spænder omløberen, som beskrevet. Hvis du spænder for meget kan samlingen blive utæt eller i værste fald gå fra hinanden under tryk.

Hvis godstykkelsen er mindre end eller lig med 10% af rørets diameter anbefaler vi at bruge støttebøsninger.

Teknisk information

Monteringsinstruktion iflg. DIN 3859

For at få en korrekt montering, skal man overholde alle punkter. Hvis ikke, risikerer man en utæt samling.

Forberedelse af rør:

1. Sav røret af i en ret vinkel (max. vinkelforskydning ½%). Brug aldrig en rørskærer!
2. Afgrat let indvendigt og udvendigt på røret. Korrekt afgratning er <math><0,2 \times 45^\circ</math>. Fjern det afgratede materiale samt andre fremmede partikler.
3. Ang. bukkede rørender: Minimum lige rørlængde efter rørbukning = 2 gange højden af omløber.

Montage af skæring:

Skæring skal ALTID formonteres og det nemmeste er at spænde fittingen fast i en skruetvinge imens.

4. Alle gevind samt skæring i kompressionsenden smøres med smørefedt. F.eks Gleitmo 810.
5. Placer skæringen korrekt - se billedet. Husk omløber på rør inden konusring.
6. Røret trykkes i bund i fittingen og omløberen tilspændes med hånden. Når skæringen har godt fat i røret, kommer der tydelig modstand. Brug derefter en sekskantsnøgle og drej omløberen 1 omgang. Røret må ikke bevæge sig hverken op eller rundt under montering. Hvis monteringen er foretaget korrekt, er der fremkommet en vulst foran skæringen.

Nu er røret parat til montering i fittingen. Placer det formonterede rørstykke i fittingsdelen. Spænd omløberen med hånden til det ikke er muligt at spænde hårdere, spænd derefter omløberen en halv omgang med sekskantsnøglen. Hold altid en sekskantsnøgle som kontra på fittingsdelen.

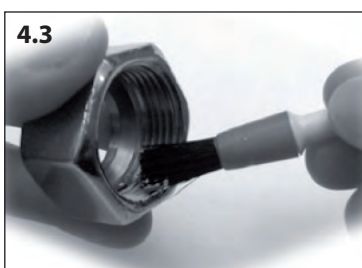
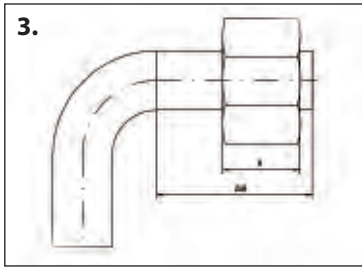
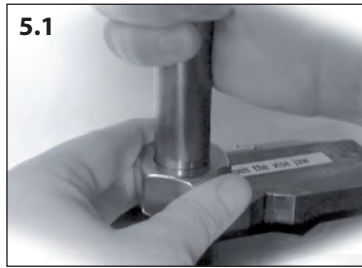
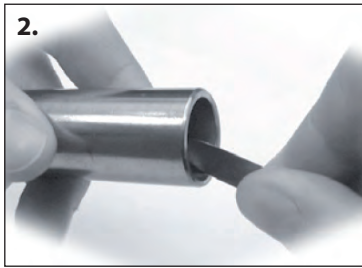
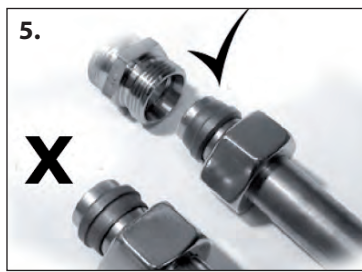
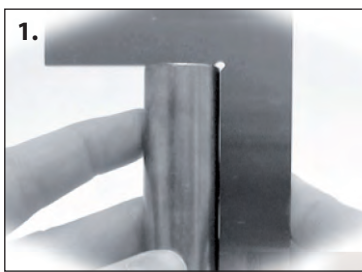

Fittingsmat.	Temperatur	Pressure reduc.
1.4571	-60°C to +20°C	-
1.4571	+50°C	5%
1.4571	+100°C	11%
1.4571	+200°C	20%
1.4571	+300°C	29%
1.4571	+400°C	33%

Svejt kalibreret rør 2m

AISI 316

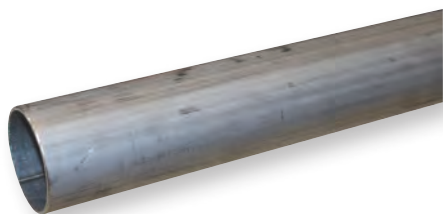

Varenr.	Ø	- -	DKK
BK35-0	4	1	218,50
BK35-1	6	1	227,25
BK35-2	8	1	279,50
BK35-3	10	1	349,50
BK35-4	12	1	419,25

Sælges kun i hele længder

Svejt kalibreret rør 6m

AISI 316

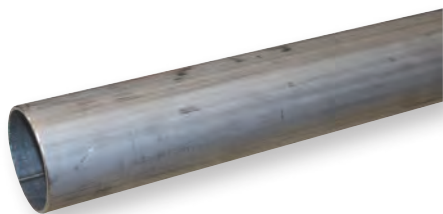

Varenr.	Ø	- -	DKK
B36-0	4	1	770,50
B36-1	6	1	321,25
B36-2	8	1	413,00
B36-3	10	1	499,25
B36-4	12	1	573,25
B36-5	15	1	692,25
B36-11-1	16	1	769,75
B36-6-2	18	1.5	923,00
B36-7-1	20	2	1264,00
B36-7	22	2	1589,50
B36-9-1	28	2	1906,75

Sælges kun i hele længder

Union skæring

AISI 316



Varenr.	Ø	Type	bar	DKK
CP1-1	4	GV-LL	100	149,75
CP1-2	6	GV-LL	100	166,50
CP1-3	8	GV-LL	100	183,50
CP1-4	6	GV-L	500	108,50
CP1-5	8	GV-L	500	135,25
CP1-6	10	GV-L	500	167,50
CP1-7	12	GV-L	400	192,50
CP1-8	15	GV-L	400	254,25
CP1-9	18	GV-L	400	380,50
CP1-10	22	GV-L	250	492,75
CP1-11	28	GV-L	250	782,50
CP1-12	35	GV-L	250	1102,25
CP1-13	42	GV-L	250	1447,25

CP1-14	6	GV-S	800	136,25
CP1-15	8	GV-S	800	161,75
CP1-16	10	GV-S	800	201,50
CP1-17	12	GV-S	630	226,00
CP1-18	14	GV-S	630	285,75
CP1-19	16	GV-S	630	378,25
CP1-20	20	GV-S	420	538,25
CP1-21	25	GV-S	420	893,75
CP1-22	30	GV-S	420	1206,25
CP1-23	38	GV-S	420	1619,25

Leveringstid Ring

Union skæring red.

AISI 316



Varenr.	Ø	Type	bar	DKK
CP4-3	8 × 6	GR-L	500	175,50
CP4-4	10 × 6	GR-L	500	191,25
CP4-5	10 × 8	GR-L	500	215,25
CP4-6	12 × 6	GR-L	400	214,00
CP4-7	12 × 8	GR-L	400	235,00
CP4-8	12 × 10	GR-L	400	251,75
CP4-9	15 × 6	GR-L	400	265,75
CP4-10	15 × 8	GR-L	400	328,00
CP4-11	15 × 10	GR-L	400	306,00
CP4-12	15 × 12	GR-L	400	316,50
CP4-15	18 × 12	GR-L	400	451,00
CP4-16	18 × 15	GR-L	400	473,00
CP4-17	22 × 12	GR-L	250	598,00
CP4-18	22 × 15	GR-L	250	591,25
CP4-19	22 × 18	GR-L	250	627,00
CP4-23	28 × 22	GR-L	250	1032,25
CP4-25	35 × 28	GR-L	250	1342,25
CP4-27	42 × 35	GR-L	250	1786,25

CP4-28	8 × 6	GR-S	800	227,00
CP4-29	10 × 6	GR-S	800	257,50
CP4-30	10 × 8	GR-S	800	282,75
CP4-32	12 × 8	GR-S	630	310,50
CP4-33	12 × 10	GR-S	630	310,50
CP4-34	14 × 10	GR-S	630	341,25
	14 × 12	GR-S	630	321,00
CP4-39	16 × 12	GR-S	630	445,75
CP4-40	16 × 14	GR-S	630	509,00
CP4-43	20 × 12	GR-S	420	620,75
CP4-45	20 × 16	GR-S	420	702,00
CP4-47	25 × 16	GR-S	420	1101,25
CP4-48	25 × 20	GR-S	420	1170,25
CP4-50	30 × 20	GR-S	420	1547,25
CP4-51	30 × 25	GR-S	420	1618,25
CP4-55	38 × 30	GR-S	420	2028,25

Leveringstid Ring

Skotgennemføring skæringing

AISI 316



Varenr.	ø / bar	Type	Ext. dim.	DKK
CP6-4	6 / 500	GSV-L	M12*1,5	227,00
CP6-5	8 / 500	GSV-L	M14*1,5	269,00
CP6-6	10 / 500	GSV-L	M16*1,5	335,75
CP6-7	12 / 400	GSV-L	M18*1,5	364,50
CP6-8	15 / 400	GSV-L	M22*1,5	473,00
CP6-9	18 / 400	GSV-L	M26*1,5	733,50
CP6-10	22 / 250	GSV-L	M30*2	929,25
CP6-11	28 / 250	GSV-L	M36*2	1306,25
CP6-12	35 / 250	GSV-L	M45*2	1786,25
CP6-13	42 / 250	GSV-L	M52*2	2376,25
CP6-14	6 / 800	GSV-S	M14*1,5	300,00
CP6-15	8 / 800	GSV-S	M16*1,5	346,25
CP6-16	10 / 800	GSV-S	M18*1,5	396,25
CP6-17	12 / 630	GSV-S	M20*1,5	426,50
CP6-18	14 / 630	GSV-S	M22*1,5	619,75
CP6-19	16 / 630	GSV-S	M24*1,5	728,50
CP6-20	20 / 420	GSV-S	M30*2	1066,25
CP6-21	25 / 420	GSV-S	M36*2	1618,25
CP6-22	30 / 420	GSV-S	M42*2	1857,25
CP6-23	38 / 420	GSV-S	M52*2	2889,25

Leveringstid Ring

Skotgennemføring skæringing

AISI 316



Skal svejses

Varenr.	ø / bar	Type	Ext. dim.	DKK
CP8-4	6 / 500	ESV-L	18	244,25
CP8-5	8 / 500	ESV-L	20	267,50
CP8-6	10 / 500	ESV-L	22	318,75
CP8-7	12 / 400	ESV-L	25	356,00
CP8-8	15 / 400	ESV-L	28	507,75
CP8-9	18 / 400	ESV-L	32	668,00
CP8-10	22 / 250	ESV-L	36	996,75
CP8-11	28 / 250	ESV-L	40	1273,25
CP8-12	35 / 250	ESV-L	50	1618,25
CP8-13	42 / 250	ESV-L	60	2376,25
CP8-14	6 / 800	ESV-S	20	282,75
CP8-15	8 / 800	ESV-S	22	323,00
CP8-16	10 / 800	ESV-S	25	379,25
CP8-17	12 / 630	ESV-S	28	443,25
CP8-18	14 / 630	ESV-S	30	616,50
CP8-19	16 / 630	ESV-S	35	745,75
CP8-20	20 / 420	ESV-S	38	1239,25
CP8-21	25 / 420	ESV-S	45	1340,25
CP8-22	30 / 420	ESV-S	50	1652,25
CP8-23	38 / 420	ESV-S	60	2376,25

Leveringstid Ring

Nippel skæring

AISI 316 - BSPT



Varenr.	ø × BSPT	Type	bar	DKK					
CP9-0-0	4 × 1/8"	GE-LLR	100	121,50	CP9-23	22 × 1/2"	GE-LR	160	517,75
CP9-0-1	6 × 1/8"	GE-LLR	100	124,00	CP9-24	22 × 3/4"	GE-LR	160	444,50
CP9-5-1	8 × 1/8"	GE-LLR	100	134,25	CP9-25	22 × 1"	GE-LR	160	961,75
CP9-1	6 × 1/8"	GE-LR	315	141,00	CP9-27	28 × 3/4"	GE-LR	160	965,75
CP9-2	6 × 1/4"	GE-LR	315	136,25	CP9-28	28 × 1"	GE-LR	160	967,00
CP9-3	6 × 3/8"	GE-LR	315	209,00	CP9-29	28 × 1 1/4"	GE-LR	160	1299,00
CP9-4	6 × 1/2"	GE-LR	315	273,50	CP9-30	35 × 1"	GE-LR	160	1318,50
CP9-5	8 × 1/8"	GE-LR	315	141,00	CP9-31	35 × 1 1/4"	GE-LR	160	991,25
CP9-6	8 × 1/4"	GE-LR	315	141,00	CP9-33	42 × 1 1/4"	GE-LR	160	1650,25
CP9-7	8 × 3/8"	GE-LR	315	163,00	CP9-34	42 × 1 1/2"	GE-LR	160	1592,50
CP9-8	8 × 1/2"	GE-LR	315	289,75	CP9-36	6 × 1/4"	GE-SR	630	199,50
CP9-9	10 × 1/8"	GE-LR	315	228,75	CP9-39	8 × 1/4"	GE-SR	630	232,50
CP9-10	10 × 1/4"	GE-LR	315	163,00	CP9-40	8 × 3/8"	GE-SR	630	251,75
CP9-11	10 × 3/8"	GE-LR	315	169,25	CP9-42	10 × 1/4"	GE-SR	630	270,00
CP9-12	10 × 1/2"	GE-LR	315	285,75	CP9-43	10 × 3/8"	GE-SR	630	277,25
CP9-13	12 × 1/4"	GE-LR	315	233,75	CP9-46	12 × 3/8"	GE-SR	630	317,50
CP9-14	12 × 3/8"	GE-LR	315	198,25	CP9-47	12 × 1/2"	GE-SR	630	304,00
CP9-15	12 × 1/2"	GE-LR	315	223,50	CP9-48	14 × 3/8"	GE-SR	400	370,75
CP9-17	15 × 3/8"	GE-LR	315	300,00	CP9-49	14 × 1/2"	GE-SR	400	370,75
CP9-18	15 × 1/2"	GE-LR	315	253,00	CP9-51	16 × 1/2"	GE-SR	400	505,00
CP9-19	15 × 3/4"	GE-LR	315	356,00	CP9-53	20 × 1/2"	GE-SR	400	633,75
CP9-20	18 × 3/8"	GE-LR	315	287,00	CP9-54	20 × 3/4"	GE-SR	400	637,75
CP9-21	18 × 1/2"	GE-LR	315	331,00	CP9-57	25 × 1"	GE-SR	250	1002,50
CP9-22	18 × 3/4"	GE-LR	315	331,00	CP9-60	30 × 1 1/4"	GE-SR	250	1362,75

Leveringstid r

Nippel skæring

AISI 316 - BSPP



Varenr.	ø × BSPP	Type	bar	DKK
CP10-1	4 × 1/8"	GE-LG	100	125,00
CP10-2	6 × 1/8"	GE-LG	315	79,45
CP10-3	6 × 1/4"	GE-LG	315	136,25
CP10-4	6 × 3/8"	GE-LG	315	195,75
CP10-5	6 × 1/2"	GE-LG	315	198,25
CP10-6	8 × 1/8"	GE-LG	315	112,50
CP10-7	8 × 1/4"	GE-LG	315	100,25
CP10-8	8 × 3/8"	GE-LG	315	158,25
CP10-9	8 × 1/2"	GE-LG	315	195,75
CP10-10	10 × 1/8"	GE-LG	315	121,50
CP10-11	10 × 1/4"	GE-LG	315	113,75
CP10-12	10 × 3/8"	GE-LG	315	171,50
CP10-13	10 × 1/2"	GE-LG	315	215,25
CP10-14	12 × 1/4"	GE-LG	315	175,50
CP10-15	12 × 3/8"	GE-LG	315	137,25
CP10-16	12 × 1/2"	GE-LG	315	224,75
CP10-18	15 × 3/8"	GE-LG	315	220,00
CP10-19	15 × 1/2"	GE-LG	315	200,50
CP10-20	15 × 3/4"	GE-LG	315	337,75
CP10-21	18 × 3/8"	GE-LG	315	337,75
CP10-22	18 × 1/2"	GE-LG	315	260,00
CP10-23	18 × 3/4"	GE-LG	315	383,75
CP10-24-1	22 × 3/8"	GE-LG	160	270,50
CP10-24	22 × 1/2"	GE-LG	160	390,50
CP10-25	22 × 3/4"	GE-LG	160	350,50
CP10-26	22 × 1"	GE-LG	160	516,75
CP10-28	28 × 3/4"	GE-LG	160	565,75
CP10-29	28 × 1"	GE-LG	160	562,50
CP10-32	35 × 11/4"	GE-LG	160	722,75
CP10-33	35 × 11/2"	GE-LG	160	1002,00
CP10-34	42 × 11/4"	GE-LG	160	1002,00
CP10-35	42 × 11/2"	GE-LG	160	963,75

CP10-36	6 × 1/8"	GE-SG	630	284,50
CP10-37	6 × 1/4"	GE-SG	630	93,90
CP10-38	6 × 3/8"	GE-SG	630	204,25
CP10-39	6 × 1/2"	GE-SG	630	125,00
CP10-41	8 × 1/4"	GE-SG	630	114,25
CP10-42	8 × 3/8"	GE-SG	630	131,50
CP10-43	8 × 1/2"	GE-SG	630	206,75
CP10-44	10 × 1/4"	GE-SG	630	152,50
CP10-45	10 × 3/8"	GE-SG	630	147,50
CP10-46	10 × 1/2"	GE-SG	630	215,75
CP10-47	12 × 1/4"	GE-SG	630	177,50
CP10-48	12 × 3/8"	GE-SG	630	159,25
CP10-49	12 × 1/2"	GE-SG	630	237,25
CP10-50	14 × 3/8"	GE-SG	400	204,25
CP10-51	14 × 1/2"	GE-SG	400	224,75
CP10-52	16 × 3/8"	GE-SG	400	284,00
CP10-53	16 × 1/2"	GE-SG	400	281,75
CP10-54	16 × 3/4"	GE-SG	400	363,25
CP10-55	20 × 1/2"	GE-SG	400	422,75
CP10-56	20 × 3/4"	GE-SG	400	383,75
CP10-57	20 × 1"	GE-SG	400	531,75
CP10-58	25 × 3/4"	GE-SG	250	674,00
CP10-59	25 × 1"	GE-SG	250	663,25
CP10-60	25 × 11/4"	GE-SG	250	742,50
CP10-61	30 × 1"	GE-SG	250	826,25
CP10-62	30 × 11/4"	GE-SG	250	791,75
CP10-63	30 × 11/2"	GE-SG	250	898,50
CP10-64	38 × 11/4"	GE-SG	250	1032,25
CP10-65	38 × 11/2"	GE-SG	250	997,75

Leveringstid Ring

Nippel skæring

AISI 316 - MM



Varenr.	ø × MM	Type	bar	DKK
CP11-1	6 × M10*1	GE-LM	315	79,45
CP11-22	6 × M12*1,5	GE-LM	315	131,50
CP11-4	8 × M12*1,5	GE-LM	315	106,25
CP11-7	10 × M14*1,5	GE-LM	315	112,50
CP11-11	12 × M16*1,5	GE-LM	315	147,50
CP11-14	15 × M18*1,5	GE-LM	315	192,50
CP11-17	18 × M22*1,5	GE-LM	160	278,50
CP11-18	22 × M26*1,5	GE-LM	160	365,75
CP11-19	28 × M33*2	GE-LM	160	581,75
CP11-20	35 × M42*2	GE-LM	160	722,75
CP11-21	42 × M48*2	GE-LM	160	963,75
CP11-23	8 × M14*1,5	GE-SM	630	151,25
CP11-24	10 × M16*1,5	GE-SM	630	166,50
CP11-25	12 × M18*1,5	GE-SM	630	178,75
CP11-26	14 × M20*1,5	GE-SM	630	223,50
CP11-27	16 × M22*1,5	GE-SM	400	281,75
CP11-28	20 × M27*2	GE-SM	400	387,50
CP11-29	25 × M33*2	GE-SM	400	665,25
CP11-30	30 × M42*2	GE-SM	400	773,50
CP11-31	38 × M48*2	GE-SM	400	1004,25

Leveringstid Ring

Nippel skæring

AISI 316 - NPT



Varenr.	ø × NPT	Type	bar	DKK
CP47-0	4 × 1/8"	GE-LL	100	132,25
CP47-1	6 × 1/8"	GE-LL	100	146,25
CP47-2	8 × 1/8"	GE-LL	100	164,25
CP47-3	6 × 1/8"	GE-L	315	136,25
CP47-4	6 × 1/4"	GE-L	315	140,00
CP47-5	6 × 3/8"	GE-L	315	165,75
CP47-6	6 × 1/2"	GE-L	315	203,50
CP47-7	8 × 1/8"	GE-L	315	135,25
CP47-8	8 × 1/4"	GE-L	315	140,50
CP47-9	8 × 3/8"	GE-L	315	169,75
CP47-10	8 × 1/2"	GE-L	315	212,50
CP47-11	10 × 1/8"	GE-L	315	164,25
CP47-12	10 × 1/4"	GE-L	315	180,00
CP47-13	10 × 3/8"	GE-L	315	192,50
CP47-14	10 × 1/2"	GE-L	315	231,75
CP47-15	12 × 1/4"	GE-L	315	196,25
CP47-16	12 × 3/8"	GE-L	315	222,25
CP47-17	12 × 1/2"	GE-L	315	232,50
CP47-18	12 × 3/4"	GE-L	315	295,00
CP47-19	15 × 3/8"	GE-L	315	259,25
CP47-20	15 × 1/2"	GE-L	315	268,00
CP47-21	15 × 3/4"	GE-L	160	300,00
CP47-22	18 × 1/2"	GE-L	160	350,50
CP47-23	18 × 3/4"	GE-L	160	378,75
CP47-24	22 × 1/2"	GE-L	160	431,25
CP47-25	22 × 3/4"	GE-L	160	447,75

CP47-26	28 × 1"	GE-L	160	649,75
CP47-27	35 × 1 1/4"	GE-L	160	873,50
CP47-28	42 × 1 1/2"	GE-L	160	1050,75
CP47-29	6 × 1/8"	GE-S	630	140,00
CP47-30	6 × 1/4"	GE-S	630	144,50
CP47-31	6 × 3/8"	GE-S	630	215,25
CP47-32	6 × 1/2"	GE-S	630	212,50
CP47-33	8 × 1/4"	GE-S	630	168,75
CP47-34	8 × 3/8"	GE-S	630	182,00
CP47-35	8 × 1/2"	GE-S	630	222,75
CP47-36	10 × 1/4"	GE-S	630	194,75
CP47-37	10 × 3/8"	GE-S	630	201,00
CP47-38	10 × 1/2"	GE-S	630	227,50
CP47-39	12 × 1/4"	GE-S	630	218,00
CP47-40	12 × 3/8"	GE-S	630	229,00
CP47-41	12 × 1/2"	GE-S	630	220,00
CP47-42	14 × 1/2"	GE-S	400	268,50
CP47-43	16 × 1/2"	GE-S	400	367,00
CP47-44	16 × 3/4"	GE-S	400	381,50
CP47-45	20 × 1/2"	GE-S	400	459,00
CP47-46	20 × 3/4"	GE-S	400	462,50
CP47-47	20 × 1"	GE-S	400	546,50
CP47-48	25 × 3/4"	GE-S	400	726,25
CP47-49	25 × 1"	GE-S	400	726,25
CP47-50	30 × 1 1/4"	GE-S	400	987,75
CP47-51	38 × 1 1/2"	GE-S	400	1402,00

Leveringstid Ring

Vinkel 90° skæring

AISI 316



Varenr.	ø	Type	DKK
CP2-1	4	WV-LL	259,00
CP2-2	6	WV-LL	261,50
CP2-3	8	WV-LL	280,75
CP2-4	6	WV-L	211,00
CP2-5	8	WV-L	221,25
CP2-6	10	WV-L	259,00
CP2-7	12	WV-L	296,50
CP2-8	15	WV-L	390,50
CP2-9	18	WV-L	559,25
CP2-10	22	WV-L	707,00
CP2-11	28	WV-L	1306,25
CP2-12	35	WV-L	2028,25
CP2-13	42	WV-L	3200,25
CP2-14	6	WV-S	231,00
CP2-15	8	WV-S	264,75
CP2-16	10	WV-S	315,00
CP2-17	12	WV-S	358,50
CP2-18	14	WV-S	430,25
CP2-19	16	WV-S	563,50
CP2-20	20	WV-S	752,75
CP2-21	25	WV-S	1445,25
CP2-22	30	WV-S	1335,00
CP2-23	38	WV-S	3094,25

Leveringstid Ring



Vinkel 90° skæring/nippel

AISI 316 - BSPT



Varenr.	ø × BSPT	Type	bar	DKK
CP12-1	4 × 1/8"	WE-LLR	100	201,50
CP12-2	6 × 1/8"	WE-LLR	100	206,75
CP12-3	8 × 1/8"	WE-LLR	100	213,00

CP12-4	6 × 1/8"	WE-LR	315	148,75
CP12-4-1	6 × 1/4"	WE-LR	315	188,50
CP12-5-0	8 × 1/8"	WE-LR	315	194,25
CP12-5	8 × 1/4"	WE-LR	315	188,50
CP12-5-1	8 × 3/8"	WE-LR	315	223,50
CP12-5-4	8 × 1/2"	WE-LR	315	328,00
CP12-6	10 × 1/4"	WE-LR	315	204,25
CP12-6-3	10 × 3/8"	WE-LR	315	240,75
CP12-6-1	10 × 1/2"	WE-LR	315	324,00
CP12-7	12 × 1/8"	WE-LR	315	259,00
CP12-8	12 × 1/4"	WE-LR	315	236,25
CP12-9	12 × 3/8"	WE-LR	315	228,75
CP12-10	12 × 1/2"	WE-LR	315	331,00
CP12-11	15 × 3/8"	WE-LR	315	364,50
CP12-12	15 × 1/2"	WE-LR	315	310,50
CP12-14	18 × 1/2"	WE-LR	315	435,25
CP12-15	22 × 3/4"	WE-LR	160	586,75
CP12-15-1	28 × 1"	WE-LR	160	1041,50

CP12-16	6 × 1/4"	WE-SR	630	195,75
CP12-17	8 × 1/4"	WE-SR	630	239,50
CP12-17-3	8 × 3/8"	WE-SR	630	227,50
CP12-17-4	8 × 1/2"	WE-SR	630	319,75
CP12-18-2	10 × 1/4"	WE-SR	630	230,50
CP12-18	10 × 3/8"	WE-SR	630	228,75
CP12-18-4	10 × 1/2"	WE-SR	630	323,00
CP12-19-2	12 × 1/4"	WE-SR	630	314,50
CP12-19	12 × 3/8"	WE-SR	630	276,25
CP12-19-4	12 × 1/2"	WE-SR	630	326,50
CP12-20	14 × 1/2"	WE-SR	630	378,25
CP12-21	16 × 1/2"	WE-SR	400	549,00
CP12-22	20 × 3/4"	WE-SR	400	613,25
CP12-23	25 × 1"	WE-SR	400	1135,25

Leveringstid Ring

Vinkel 90° skæring/nippel

AISI 316 - BSPP



Varenr.	ø × BSPP	Type	bar	DKK
CP13-1	22 × 3/4"	WE-LG	160	601,50
CP13-2	28 × 1"	WE-LG	160	1232,00
CP13-3	35 × 1 1/4"	WE-LG	160	1892,25
CP13-4	42 × 1 1/2"	WE-LG	160	2712,00

CP13-5	20 × 3/4"	WE-SG	400	628,00
CP13-6	25 × 1"	WE-SG	250	1375,25
CP13-7	38 × 1 1/2"	WE-SG	160	2817,25

Leveringstid 3-6 dage for skaffeverer

Vinkel 90° skæring/nippel

AISI 316 - NPT



Varenr.	ø × NPT	Type	bar	DKK
CP48-1	4 × 1/8"	WE-LL	100	164,25
CP48-2	6 × 1/8"	WE-LL	100	221,75
CP48-3	8 × 1/8"	WE-LL	100	243,75

CP48-4	6 × 1/8"	WE-L	315	206,00
CP48-4-1	6 × 1/4"	WE-L	315	218,00
CP48-5	8 × 1/4"	WE-L	315	242,00
CP48-6	10 × 1/4"	WE-L	315	281,75
CP48-8	12 × 1/4"	WE-L	315	303,50
CP48-9	12 × 3/8"	WE-L	315	303,50
CP48-10	12 × 1/2"	WE-L	315	364,50
CP48-12	15 × 1/2"	WE-L	315	382,00
CP48-14	18 × 1/2"	WE-L	315	563,50
CP48-15	22 × 3/4"	WE-L	160	643,75
CP48-15-1	28 × 1"	WE-L	160	1211,50
CP48-15-2	35 × 1 1/4"	WE-L	160	1881,00
CP48-15-3	42 × 1 1/2"	WE-L	160	2581,25

CP48-16	6 × 1/4"	WE-S	630	224,75
CP48-17	8 × 1/4"	WE-S	630	271,25
CP48-18	10 × 3/8"	WE-S	630	294,00
CP48-19	12 × 3/8"	WE-S	630	359,25
CP48-20	14 × 1/2"	WE-S	630	400,00
CP48-21	16 × 1/2"	WE-S	400	554,25
CP48-22	20 × 3/4"	WE-S	400	649,75
CP48-23	25 × 1"	WE-S	400	1434,00
CP48-24	30 × 1 1/4"	WE-S	400	2104,50
CP48-25	38 × 1 1/2"	WE-S	315	2835,75

Skotgennemf. 90° skæring

AISI 316



Varenr.	ø / bar	Type	Ext. dim.	DKK
CP7-4	6 / 315	WSV-L	M12*1,5	420,25
CP7-5	8 / 315	WSV-L	M14*1,5	462,00
CP7-6	10 / 315	WSV-L	M16*1,5	539,50
CP7-7	12 / 315	WSV-L	M18*1,5	658,75
CP7-8	15 / 315	WSV-L	M22*1,5	774,50
CP7-9	18 / 315	WSV-L	M26*1,5	1032,25
CP7-10	22 / 160	WSV-L	M30*2	1410,25
CP7-11	28 / 160	WSV-L	M36*2	1963,25
CP7-12	35 / 160	WSV-L	M45*2	2752,25
CP7-13	42 / 160	WSV-L	M52*2	4026,50

CP7-14	6 / 630	WSV-S	M12*1,5	520,00
CP7-15	8 / 630	WSV-S	M14*1,5	534,00
CP7-16	10 / 630	WSV-S	M16*1,5	565,75
CP7-17	12 / 630	WSV-S	M18*1,5	627,00
CP7-18	14 / 630	WSV-S	M22*1,5	784,50
CP7-19	16 / 400	WSV-S	M24*1,5	895,25
CP7-20	20 / 400	WSV-S	M30*2	1675,00
CP7-21	25 / 400	WSV-S	M36*2	2234,25
CP7-22	30 / 400	WSV-S	M42*2	3030,50
CP7-23	38 / 400	WSV-S	M52*2	4574,25

CP7-14	6 / 630	WSV-S	M12*1,5	520,00
CP7-15	8 / 630	WSV-S	M14*1,5	534,00
CP7-16	10 / 630	WSV-S	M16*1,5	565,75
CP7-17	12 / 630	WSV-S	M18*1,5	627,00
CP7-18	14 / 630	WSV-S	M22*1,5	784,50
CP7-19	16 / 400	WSV-S	M24*1,5	895,25
CP7-20	20 / 400	WSV-S	M30*2	1675,00
CP7-21	25 / 400	WSV-S	M36*2	2234,25
CP7-22	30 / 400	WSV-S	M42*2	3030,50
CP7-23	38 / 400	WSV-S	M52*2	4574,25

Leveringstid Ring

T-stk skæring AISI 316



Varenr.	∅	Type	bar	DKK
CP3-1	4	TV-LL	100	397,25
CP3-2	6	TV-LL	100	419,00
CP3-3	8	TV-LL	100	460,50
CP3-4	6	TV-L	500	292,25
CP3-5	8	TV-L	500	312,75
CP3-6	10	TV-L	500	347,75
CP3-7	12	TV-L	400	426,50
CP3-8	15	TV-L	400	606,00
CP3-9	18	TV-L	400	826,25
CP3-10	22	TV-L	2501	1169,25
CP3-11	28	TV-L	2501	1821,25
CP3-12	35	TV-L	2503	130,25
CP3-13	42	TV-L	2504	403,25
CP3-14	6	TV-S	800	318,75
CP3-15	8	TV-S	800	351,00
CP3-16	10	TV-S	800	434,00
CP3-17	12	TV-S	630	533,00
CP3-18	14	TV-S	630	587,75
CP3-19	16	TV-S	630	826,25
CP3-20	20	TV-S	4201	170,25
CP3-21	25	TV-S	4201	963,25
CP3-22	30	TV-S	4202	958,25
CP3-23	38	TV-S	4204	609,25

Leveringstid Ring

T-stk skæring/nippel gren AISI 316 - BSPT



Varenr.	∅ × BSPT × ∅	Type	bar	DKK
CP14-1	4 × 1/8" × 4	TE-LLR	100	410,75
CP14-2	6 × 1/8" × 6	TE-LLR	100	410,75
CP14-3	8 × 1/8" × 8	TE-LLR	100	417,00
CP14-4	6 × 1/8" × 6	TE-LR	315	322,00
CP14-5-1	8 × 1/8" × 8	TE-LR	315	357,25
CP14-5	8 × 1/4" × 8	TE-LR	315	381,50
CP14-6	10 × 1/4" × 10	TE-LR	315	418,00
CP14-7-1	12 × 1/4" × 12	TE-LR	315	688,75
CP14-7	12 × 3/8" × 12	TE-LR	315	467,50
CP14-8	15 × 1/2" × 15	TE-LR	315	640,25
CP14-9	18 × 1/2" × 18	TE-LR	315	929,25
CP14-14	6 × 1/4" × 6	TE-SR	630	385,00
CP14-15	8 × 1/4" × 8	TE-SR	630	420,25
CP14-16	10 × 3/8" × 10	TE-SR	630	471,75
CP14-17	12 × 3/8" × 12	TE-SR	630	598,00
CP14-18	14 × 1/2" × 14	TE-SR	630	622,25
CP14-19	16 × 1/2" × 16	TE-SR	400	929,25

Leveringstid Ring

T-stk skæring/nippel gren AISI 316 - NPT



Varenr.	∅ × NPT × ∅	Type	bar	DKK
CP16-1	6 × 1/8" × 6	TE-L	315	415,75
CP16-2	6 × 1/4" × 6	TE-L	315	384,50
CP16-3	8 × 1/4" × 8	TE-L	315	407,50
CP16-4	10 × 1/4" × 10	TE-L	315	450,00
CP16-5	12 × 3/8" × 12	TE-L	315	543,00
CP16-6	18 × 1/2" × 18	TE-L	315	1206,25
CP16-7	22 × 3/4" × 22	TE-L	160	1271,25
CP16-8	28 × 1" × 28	TE-L	160	2087,00
CP16-9	35 × 1 1/4" × 35	TE-L	160	3944,00
CP16-10	42 × 1 1/2" × 42	TE-L	160	4044,00
CP16-11	6 × 1/4" × 6	TE-S	630	419,00
CP16-12	8 × 1/4" × 8	TE-S	630	428,50
CP16-13	10 × 3/8" × 10	TE-S	630	522,75
CP16-14	12 × 3/8" × 12	TE-S	630	611,50
CP16-15	14 × 1/2" × 14	TE-S	630	750,00
CP16-16	16 × 1/2" × 16	TE-S	400	1173,25
CP16-17	20 × 3/4" × 20	TE-S	400	1434,00
CP16-18	25 × 1" × 25	TE-S	400	2216,75
CP16-19	30 × 1 1/4" × 30	TE-S	400	2965,50
CP16-20	38 × 1 1/2" × 38	TE-S	315	5510,50

Leveringstid Ring

T-stk skæring/nippel gren AISI 316 - BSPP



Varenr.	∅ × BSPP × ∅	Type	bar	DKK
CP14-10	22 × 3/4" × 22	TE-LG	160	1176,50
CP14-11	28 × 1" × 28	TE-LG	160	1803,75
CP14-12	35 × 1 1/4" × 35	TE-LG	160	3360,00
CP14-13	42 × 1 1/2" × 42	TE-LG	160	3507,25
CP14-20	20 × 3/4" × 20	TE-SG	400	1104,25
CP14-21	25 × 1" × 25	TE-SG	250	2063,25
CP14-22	30 × 1 1/4" × 30	TE-SG	160	2552,50
CP14-23	38 × 1 1/2" × 38	TE-SG	160	4686,50

Leveringstid Ring

T-stk skæring/nip ende AISI 316 - BSPT



Varenr.	BSPT × ∅ × ∅	Type	DKK
CP17-1	1/8" × 6 × 6	TE-LR	303,00
CP17-2	1/4" × 8 × 8	TE-LR	353,50
CP17-3	1/4" × 10 × 10	TE-LR	418,00
CP17-4	3/8" × 12 × 12	TE-LR	433,50
CP17-5	1/2" × 15 × 15	TE-LR	591,75
CP17-6	1/2" × 18 × 18	TE-LR	860,00
CP17-7	1/4" × 6 × 6	TE-SR	356,50
CP17-8	1/4" × 8 × 8	TE-SR	388,75
CP17-9	3/8" × 10 × 10	TE-SR	436,75
CP17-10	3/8" × 12 × 12	TE-SR	553,75
CP17-11	1/2" × 14 × 14	TE-SR	622,25
CP17-12	1/2" × 16 × 16	TE-SR	860,00

Leveringstid Ring

T-stk skæring/nip ende

AISI 316 - MM



Varenr.	MM × ø × ø	Type	DKK
CP18-1	M10*1 × 6 × 6	GE-LM	73,45
CP18-7	M12*1,5 × 6 × 6	GE-LM	121,25
CP18-2	M12*1,5 × 8 × 8	GE-LM	98,30
CP18-3	M14*1,5 × 10 × 10	GE-LM	104,00
CP18-4	M16*1,5 × 12 × 12	GE-LM	239,00
CP18-5	M18*1,5 × 15 × 15	GE-LM	243,25
CP18-6	M22*1,5 × 18 × 18	GE-LM	257,50
CP18-8	M14*1,5 × 8 × 8	GE-SM	140,50
CP18-9	M16*1,5 × 10 × 10	GE-SM	154,50
CP18-10	M18*1,5 × 12 × 12	GE-SM	163,75
CP18-11	M20*1,5 × 14 × 14	GE-SM	208,00
CP18-12	M22*1,5 × 16 × 16	GE-SM	262,25

Leveringstid Ring

Kryds skæring

AISI 316



Varenr.	ø	Type	bar	DKK
CP5-4	6	KV-L	315	546,50
CP5-5	8	KV-L	315	598,00
CP5-6	10	KV-L	315	763,75
CP5-7	12	KV-L	315	793,00
CP5-8	15	KV-L	315	1032,25
CP5-9	18	KV-L	315	1513,25
CP5-10	22	KV-L	160	2028,25
CP5-11	28	KV-L	160	2788,25
CP5-12	35	KV-L	160	3613,25
CP5-13	42	KV-L	160	5570,25
CP5-14	6	KV-S	630	605,00
CP5-15	8	KV-S	630	776,00
CP5-16	10	KV-S	630	859,50
CP5-17	12	KV-S	630	997,75
CP5-18	14	KV-S	630	1066,25
CP5-19	16	KV-S	400	1449,25
CP5-20	20	KV-S	400	1992,25
CP5-21	25	KV-S	400	3300,25
CP5-22	30	KV-S	400	3643,25
CP5-23	38	KV-S	315	6259,50

Leveringstid Ring

Påskruining skæring

AISI 316



Varenr.	ø	Type	bar	DKK
CP49-1	8 × 6	KOR-L	315	167,50
CP49-2	10 × 6	KOR-L	315	175,50
CP49-3	10 × 8	KOR-L	315	209,00
CP49-4	12 × 6	KOR-L	315	233,75
CP49-5	12 × 8	KOR-L	315	247,50
CP49-6	12 × 10	KOR-L	315	251,75
CP49-7	15 × 6	KOR-L	315	265,75
CP49-8	15 × 8	KOR-L	315	272,25
CP49-9	15 × 10	KOR-L	315	272,25
CP49-10	15 × 12	KOR-L	315	281,75
CP49-11	18 × 6	KOR-L	315	328,00
CP49-12	18 × 8	KOR-L	315	297,75
CP49-13	18 × 10	KOR-L	315	296,50
CP49-14	18 × 12	KOR-L	315	343,75
CP49-15	18 × 15	KOR-L	315	348,50
CP49-16	22 × 6	KOR-L	160	382,50
CP49-17	22 × 8	KOR-L	160	367,75
CP49-18	22 × 10	KOR-L	160	380,50
CP49-19	22 × 12	KOR-L	160	415,75
CP49-20	22 × 15	KOR-L	160	462,00
CP49-21	22 × 18	KOR-L	160	511,25
CP49-22	28 × 6	KOR-L	160	512,50
CP49-23	28 × 8	KOR-L	160	534,75
CP49-24	28 × 10	KOR-L	160	552,50
CP49-25	28 × 12	KOR-L	160	570,75
CP49-26	28 × 15	KOR-L	160	579,25
CP49-27	28 × 18	KOR-L	160	643,75
CP49-28	28 × 22	KOR-L	160	685,25
CP49-29	35 × 6	KOR-L	160	686,25
CP49-30	35 × 8	KOR-L	160	788,00
CP49-31	35 × 10	KOR-L	160	810,00
CP49-32	35 × 12	KOR-L	160	810,00
CP49-33	35 × 15	KOR-L	160	826,25
CP49-34	35 × 18	KOR-L	160	859,50
CP49-35	35 × 22	KOR-L	160	859,50
CP49-36	35 × 28	KOR-L	160	895,25
CP49-37	42 × 10	KOR-L	160	1020,75
CP49-38	42 × 12	KOR-L	160	964,75
CP49-39	42 × 15	KOR-L	160	1092,00
CP49-40	42 × 18	KOR-L	160	1092,00
CP49-41	42 × 22	KOR-L	160	1101,25
CP49-42	42 × 28	KOR-L	160	1136,25
CP49-43	42 × 35	KOR-L	160	1205,25

Leveringstid Ring

Påskruining skæring

AISI 316



Varenr.	ø	Type	bar	DKK
CP50-1	8 × 6	KOR-S	630	236,25
CP50-2	10 × 6	KOR-S	630	239,50
CP50-3	10 × 8	KOR-S	630	246,50
CP50-4	12 × 6	KOR-S	630	257,50
CP50-5	12 × 8	KOR-S	630	277,25
CP50-6	12 × 10	KOR-S	630	288,00
CP50-7	14 × 6	KOR-S	630	285,75
CP50-8	14 × 8	KOR-S	630	294,50
CP50-9	14 × 10	KOR-S	630	301,25
CP50-10	14 × 12	KOR-S	630	328,00
CP50-11	16 × 6	KOR-S	400	361,00
CP50-12	16 × 8	KOR-S	400	362,25
CP50-13	16 × 10	KOR-S	400	367,00
CP50-14	16 × 12	KOR-S	400	393,75
CP50-15	16 × 14	KOR-S	400	381,50
CP50-16	20 × 6	KOR-S	400	398,75
CP50-17	20 × 8	KOR-S	400	401,25
CP50-18	20 × 10	KOR-S	400	448,50
CP50-19	20 × 12	KOR-S	400	445,75
CP50-20	20 × 14	KOR-S	400	479,75
CP50-21	20 × 16	KOR-S	400	544,50
CP50-22	25 × 6	KOR-S	400	599,25
CP50-23	25 × 8	KOR-S	400	602,50
CP50-24	25 × 10	KOR-S	400	618,75
CP50-25	25 × 12	KOR-S	400	715,25
CP50-26	25 × 14	KOR-S	400	686,25
CP50-27	25 × 16	KOR-S	400	722,75
CP50-28	25 × 20	KOR-S	400	826,25
CP50-29	30 × 6	KOR-S	400	915,50
CP50-30	30 × 8	KOR-S	400	915,50
CP50-31	30 × 10	KOR-S	400	950,75
CP50-32	30 × 12	KOR-S	400	986,50
CP50-33	30 × 14	KOR-S	400	1053,75
CP50-34	30 × 16	KOR-S	400	1032,25
CP50-35	30 × 20	KOR-S	400	1066,25
CP50-36	30 × 25	KOR-S	400	1136,25
CP50-37	38 × 6	KOR-S	250	1268,00
CP50-38	38 × 8	KOR-S	250	1268,00
CP50-39	38 × 10	KOR-S	250	1268,00
CP50-40	38 × 12	KOR-S	250	1268,00
CP50-41	38 × 14	KOR-S	250	1373,00
CP50-42	38 × 16	KOR-S	250	1373,00
CP50-43	38 × 20	KOR-S	250	1342,25
CP50-44	38 × 20	KOR-S	250	1513,25

Leveringstid Ring

Vinkel 90° skæring svivel

AISI 316



Varenr.	∅	Type	bar	DKK
CP35-1	6	EVW-L	315	253,00
CP35-2	8	EVW-L	315	261,50
CP35-3	10	EVW-L	315	343,75
CP35-4	12	EVW-L	315	401,25
CP35-5	15	EVW-L	315	517,75
CP35-6	18	EVW-L	315	744,75
CP35-7	22	EVW-L	160	895,25
CP35-8	28	EVW-L	160	1273,25
CP35-9	35	EVW-L	160	1892,25
CP35-10	42	EVW-L	160	2718,25

CP35-11	6	EVW-S	630	293,25
CP35-12	8	EVW-S	630	354,00
CP35-13	10	EVW-S	630	398,75
CP35-14	12	EVW-S	630	476,50
CP35-15	14	EVW-S	630	558,25
CP35-16	16	EVW-S	400	752,75
CP35-17	20	EVW-S	400	929,25
CP35-18	25	EVW-S	400	1342,25
CP35-19	30	EVW-S	400	1927,25
CP35-20	38	EVW-S	250	2788,25

Leveringstid Ring

T-stk skæring/svivel gren

AISI 316



Varenr.	∅	Type	DKK
CP39-1	6	ETV-L	376,50
CP39-2	8	ETV-L	415,25
CP39-3	10	ETV-L	504,00
CP39-4	12	ETV-L	567,25
CP39-5	15	ETV-L	751,50
CP39-6	18	ETV-L	987,75
CP39-7	22	ETV-L	1083,75
CP39-8	28	ETV-L	1720,25
CP39-9	35	ETV-L	2770,75
CP39-10	42	ETV-L	3673,00

CP39-11	6	ETV-S	388,75
CP39-12	8	ETV-S	467,00
CP39-13	10	ETV-S	503,50
CP39-14	12	ETV-S	540,00
CP39-15	14	ETV-S	721,75
CP39-16	16	ETV-S	923,75
CP39-17	20	ETV-S	1242,25
CP39-18	25	ETV-S	1909,75
CP39-19	30	ETV-S	2517,50
CP39-20	38	ETV-S	3920,25

Leveringstid Ring

Påskruet skæring/nippel

AISI 316 - BSPP



Varenr.	∅ × BSPP	Type	bar	DKK
CP21-1	6 × 1/8"	EVGE-LG	315	184,75
CP21-2	8 × 1/4"	EVGE-LG	315	200,50
CP21-3	10 × 1/4"	EVGE-LG	315	224,75
CP21-4	12 × 3/8"	EVGE-LG	315	242,00
CP21-5	15 × 1/2"	EVGE-LG	315	276,75
CP21-6	18 × 1/2"	EVGE-LG	315	401,75
CP21-7	22 × 3/4"	EVGE-LG	160	501,25
CP21-8	28 × 1"	EVGE-LG	160	764,75
CP21-9	35 × 1 1/4"	EVGE-LG	160	1306,25
CP21-10	42 × 1 1/2"	EVGE-LG	160	1370,00

CP21-11	6 × 1/4"	EVGE-SG	630	183,50
CP21-12	8 × 1/4"	EVGE-SG	630	190,25
CP21-13	10 × 3/8"	EVGE-SG	630	226,50
CP21-14	12 × 3/8"	EVGE-SG	630	255,25
CP21-15	12 × 1/2"	EVGE-SG	630	268,50
CP21-16	14 × 1/2"	EVGE-SG	630	315,50
CP21-17	16 × 1/2"	EVGE-SG	400	430,25
CP21-18	16 × 3/4"	EVGE-SG	400	483,00
CP21-19	20 × 3/4"	EVGE-SG	400	556,50
CP21-20	25 × 1"	EVGE-SG	400	860,00
CP21-21	30 × 1 1/4"	EVGE-SG	400	1019,25

CP21-22 38 × 1 1/2" EVGE-SG 315 1370,00
Leveringstid Ring



468

Påskruning skæring/nippel

AISI 316 - MM



Varenr.	ø × MM	Type	bar	DKK
CP25-1	6 × M10*1	EVGE-LM	315	184,75
CP25-4	8 × M12*1,5	EVGE-LM	315	186,25
CP25-7	10 × M14*1,5	EVGE-LM	315	205,50
CP25-11	12 × M16*1,5	EVGE-LM	315	234,25
CP25-14	15 × M18*1,5	EVGE-LM	315	292,25
CP25-17	18 × M22*1,5	EVGE-LM	315	414,75
CP25-18	22 × M26*1,5	EVGE-LM	160	507,75
CP25-19	28 × M33*2	EVGE-LM	160	764,75
CP25-20	35 × M42*2	EVGE-LM	160	1242,25
CP25-21	42 × M48*2	EVGE-LM	160	1370,00

CP25-22	6 × M12*1,5	EVGE-SM	630	180,00
CP25-23	8 × M14*1,5	EVGE-SM	630	196,75
CP25-24	10 × M16*1,5	EVGE-SM	630	227,50
CP25-25	12 × M18*1,5	EVGE-SM	630	251,75
CP25-26	14 × M20*1,5	EVGE-SM	630	304,00
CP25-27	16 × M22*1,5	EVGE-SM	400	417,50
CP25-28	20 × M27*2	EVGE-SM	400	577,25
CP25-29	25 × M33*2	EVGE-SM	400	860,00
CP25-30	30 × M42*2	EVGE-SM	400	1019,25
CP25-31	38 × M48*2	EVGE-SM	315	1561,50

Leveringstid Ring

Påskruning skæring/nippel

AISI 316 - NPT



Varenr.	ø × NPT	Type	bar	DKK
CP23-1	6 × 1/8"	EVG-L	315	153,50
CP23-2	8 × 1/4"	EVG-L	315	171,50
CP23-3	10 × 1/4"	EVG-L	315	188,50
CP23-4	12 × 3/8"	EVG-L	315	231,00
CP23-5	15 × 1/2"	EVG-L	315	289,75
CP23-6	18 × 1/2"	EVG-L	315	455,75
CP23-7	22 × 3/4"	EVG-L	160	559,25
CP23-8	28 × 1"	EVG-L	160	880,50
CP23-9	35 × 1 1/4"	EVG-L	160	1466,75
CP23-10	42 × 1 1/2"	EVG-L	160	1597,75

CP23-11	6 × 1/4"	EVG-S	630	174,25
CP23-12	8 × 1/4"	EVG-S	630	183,50
CP23-13	10 × 3/8"	EVG-S	630	219,00
CP23-14	12 × 3/8"	EVG-S	630	272,25
CP23-15	14 × 1/2"	EVG-S	630	328,00
CP23-16	16 × 1/2"	EVG-S	400	471,25
CP23-17	20 × 3/4"	EVG-S	400	602,50
CP23-18	25 × 3/4"	EVG-S	400	892,00
CP23-19	25 × 1"	EVG-S	400	971,25
CP23-20	30 × 1"	EVG-S	400	1204,25
CP23-21	30 × 1 1/4"	EVG-S	400	1597,75

CP23-22 38 × 1 1/2" EVG-S 315 1739,75
Leveringstid Ring

Svejsenippel skæring

AISI 316



Varenr.	ø	Type	bar	DKK
CP46-1	6	ASV-L	500	110,25
CP46-2	8	ASV-L	500	122,00
CP46-3	10	ASV-L	500	147,50
CP46-4	12	ASV-L	400	140,50
CP46-5	15	ASV-L	400	177,00
CP46-6	18	ASV-L	400	292,25
CP46-7	22	ASV-L	250	420,25
CP46-8	28	ASV-L	250	567,25
CP46-9	35	ASV-L	250	733,00
CP46-10	42	ASV-L	250	987,75

CP46-11	6	ASV-S	800	134,75
CP46-12	8	ASV-S	800	152,50
CP46-13	10	ASV-S	800	167,00
CP46-14	12	ASV-S	630	169,25
CP46-15	14	ASV-S	630	225,50
CP46-16	16	ASV-S	630	297,75
CP46-17	20	ASV-S	420	447,00
CP46-18	25	ASV-S	420	640,25
CP46-19	30	ASV-S	420	790,25
CP46-20	38	ASV-S	420	1050,75

Leveringstid Ring

Muffe skæring

AISI 316 - BSPP



Varenr.	ø × BSPP	Type	DKK
CP26-1	6 × 1/8"	GAV-LG	161,75
CP26-2	8 × 1/4"	GAV-LG	214,00
CP26-3	8 × 3/8"	GAV-LG	270,00
CP26-4	10 × 1/4"	GAV-LG	213,00
CP26-5	10 × 3/8"	GAV-LG	259,00
CP26-6	10 × 1/2"	GAV-LG	404,75
CP26-7	12 × 3/8"	GAV-LG	251,75
CP26-8	15 × 1/2"	GAV-LG	335,75
CP26-9	18 × 1/2"	GAV-LG	422,75
CP26-10	22 × 3/4"	GAV-LG	517,75
CP26-11	28 × 1"	GAV-LG	768,75
CP26-12	35 × 1 1/4"	GAV-LG	1205,25
CP26-13	42 × 1 1/2"	GAV-LG	1513,25
CP26-14	6 × 1/4"	GAV-SG	215,25
CP26-15	8 × 1/4"	GAV-SG	220,00
CP26-16	10 × 3/8"	GAV-SG	289,75
CP26-17	12 × 3/8"	GAV-SG	301,25
CP26-18	14 × 3/8"	GAV-SG	451,00
CP26-19	14 × 1/2"	GAV-SG	351,00
CP26-20	16 × 1/2"	GAV-SG	372,50
CP26-21	20 × 3/4"	GAV-SG	536,75
CP26-22	25 × 1"	GAV-SG	1114,50
CP26-23	30 × 1 1/4"	GAV-SG	1410,25
CP26-24	38 × 1 1/2"	GAV-SG	1720,25

Leveringstid Ring

Manometer pakn. skæring

AISI 316

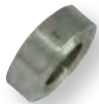

Varenr.	dim	Type	DKK
CP76-1	11,3 ~ 1/4"	DKRi	50,05
CP76-2	18,5 ~ 1/2"	DKRi	-

Leveringstid Ring

Pakning til indv. gev.

PTFE (TEFLON)



Varenr.	dim	DKK
C5-2I	1/4"	59,25
C5-3I	3/8"	80,55
C5-4I	1/2"	81,40

Muffe skæring

AISI 316 - MM



Varenr.	ø × MM	Type	DKK
CP27-1	6 × M10*1	GAV-LM	190,25
CP27-2	8 × M12*1,5	GAV-LM	223,50
CP27-3	10 × M14*1,5	GAV-LM	261,50
CP27-4	12 × M16*1,5	GAV-LM	312,75
CP27-5	15 × M18*1,5	GAV-LM	442,00
CP27-6	18 × M22*1,5	GAV-LM	481,25
CP27-18	22 × M26*1,5	GAV-LM	524,75
CP27-19	28 × M33*2	GAV-LM	764,75
CP27-20	35 × M42*2	GAV-LM	1275,25
CP27-21	42 × M48*2	GAV-LM	1688,25
CP27-22	6 × M12*1,5	GAV-SM	210,00
CP27-23	8 × M14*1,5	GAV-SM	239,00
CP27-24	10 × M16*1,5	GAV-SM	291,00
CP27-25	12 × M18*1,5	GAV-SM	343,75
CP27-26	14 × M20*1,5	GAV-SM	417,50
CP27-27	16 × M22*1,5	GAV-SM	458,50
CP27-28	20 × M27*2	GAV-SM	586,25
CP27-29	25 × M33*2	GAV-SM	796,50
CP27-30	30 × M42*2	GAV-SM	1285,50
CP27-31	38 × M48*2	GAV-SM	1720,25

Leveringstid Ring

Prop skæring

AISI 316 / NBR

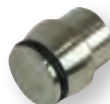

Varenr.	ø	Type	bar	DKK
CP56-1	6	VKA-L	500	67,75
CP56-2	8	VKA-L	500	71,80
CP56-3	10	VKA-L	500	83,00
CP56-4	12	VKA-L	400	93,90
CP56-5	15	VKA-L	400	109,25
CP56-6	18	VKA-L	400	141,00
CP56-7	22	VKA-L	250	193,75
CP56-8	28	VKA-L	250	282,75
CP56-9	35	VKA-L	250	491,75
CP56-10	42	VKA-L	250	614,25

CP56-15	14	VKA-S	630	110,25
CP56-16	16	VKA-S	630	137,25
CP56-17	20	VKA-S	420	184,75
CP56-18	25	VKA-S	420	243,00
CP56-19	30	VKA-S	420	393,75
CP56-20	38	VKA-S	420	581,75

Leveringstid Ring

Banjo skæring/nippel

AISI 316 - BSPP



Varenr.	ø × BSPP	Type	bar	DKK
CP30-1	4 × 1/8"	WHV-LLG	100	988,25
CP30-2	6 × 1/8"	WHV-LLG	100	988,25
CP30-3	8 × 1/8"	WHV-LLG	100	960,50
CP30-4	6 × 1/8"	WHV-LG	500	931,50
CP30-5	8 × 1/4"	WHV-LG	400	993,75
CP30-6	10 × 1/4"	WHV-LG	350	1087,75
CP30-7	12 × 1/4"	WHV-LG	350	1425,75
CP30-8	12 × 3/8"	WHV-LG	350	1303,00
CP30-9	15 × 1/2"	WHV-LG	315	1583,25
CP30-10	18 × 1/2"	WHV-LG	315	2069,50
CP30-11	22 × 3/4"	WHV-LG	200	3218,75
CP30-12	28 × 1"	WHV-LG	200	4780,25
CP30-13	35 × 1 1/4"	WHV-LG	200	7067,00
CP30-14	42 × 1 1/2"	WHV-LG	200	10001,50
CP30-15	6 × 1/4"	WHV-SG	500	1050,75
CP30-16	8 × 1/4"	WHV-SG	450	1146,50
CP30-17	10 × 1/4"	WHV-SG	450	1478,25
CP30-18	10 × 3/8"	WHV-SG	450	1306,25
CP30-19	12 × 3/8"	WHV-SG	450	1465,75
CP30-20	14 × 1/2"	WHV-SG	450	1720,25
CP30-21	16 × 1/2"	WHV-SG	450	2134,25
CP30-22	20 × 3/4"	WHV-SG	450	3248,75
CP30-23	25 × 1"	WHV-SG	250	5127,50
CP30-24	30 × 1 1/4"	WHV-SG	250	7580,00
CP30-25	38 × 1 1/2"	WHV-SG	250	10671,00

Leveringstid Ring



468

Kontraventil skæring/nip

AISI 316 - BSPP



Højtryk 100-400 bar

Varenr.	ø × BSPP	Type	bar	DKK
CP74-1	6 × 1/8"	RV-LG	250	722,75
CP74-2	8 × 1/4"	RV-LG	250	791,75
CP74-3	10 × 1/4"	RV-LG	250	929,25
CP74-4	12 × 3/8"	RV-LG	250	1101,25
CP74-5	15 × 1/2"	RV-LG	250	1239,25
CP74-6	18 × 1/2"	RV-LG	160	1617,25
CP74-7	22 × 3/4"	RV-LG	160	2340,25
CP74-8	28 × 1"	RV-LG	100	3130,25
CP74-9	35 × 1 1/4"	RV-LG	100	4503,25
CP74-10	42 × 1 1/2"	RV-LG	100	6359,25

CP74-11	6 × 1/4"	RV-SG	630	791,75
CP74-12	8 × 1/4"	RV-SG	630	826,25
CP74-13	10 × 3/8"	RV-SG	630	963,75
CP74-14	12 × 3/8"	RV-SG	630	1032,25
CP74-15	14 × 1/2"	RV-SG	630	1170,25
CP74-16	16 × 1/2"	RV-SG	400	1410,25
CP74-17	20 × 3/4"	RV-SG	400	2234,25
CP74-18	25 × 1"	RV-SG	400	2853,25
CP74-19	30 × 1 1/4"	RV-SG	400	4126,25
CP74-20	38 × 1 1/2"	RV-SG	400	5570,25

Leveringstid Ring

Kontraventil skæring

AISI 316



Højtryk 100-400 bar

Varenr.	ø	Type	bar	DKK
CP75-1	6	RD-L	250	756,75
CP75-2	8	RD-L	250	826,25
CP75-3	10	RD-L	250	1032,25
CP75-4	12	RD-L	250	1136,25
CP75-5	15	RD-L	250	1342,25
CP75-6	18	RD-L	160	1754,25
CP75-7	22	RD-L	160	2340,25
CP75-8	28	RD-L	100	3000,50
CP75-9	35	RD-L	100	4091,25
CP75-10	42	RD-L	100	6153,25

CP75-11	6	RD-S	630	859,50
CP75-12	8	RD-S	630	895,25
CP75-13	10	RD-S	630	997,75
CP75-14	12	RD-S	630	1101,25
CP75-15	14	RD-S	630	1239,25
CP75-16	16	RD-S	400	1513,25
CP75-17	20	RD-S	400	2340,25
CP75-18	25	RD-S	400	2812,00
CP75-19	30	RD-S	400	4161,25
CP75-20	38	RD-S	400	5982,25

Leveringstid Ring

Kontraventil skæring/nip

AISI 316 - BSPP



Højtryk 100-400 bar

Varenr.	ø × BSPP	Type	bar	DKK
CP72-1	6 × 1/8"	RZ-LG	250	722,75
CP72-2	8 × 1/4"	RZ-LG	250	791,75
CP72-3	10 × 1/4"	RZ-LG	250	929,25
CP72-4	12 × 3/8"	RZ-LG	250	1101,25
CP72-5	15 × 1/2"	RZ-LG	250	1239,25
CP72-6	18 × 1/2"	RZ-LG	160	1617,25
CP72-7	22 × 3/4"	RZ-LG	160	2340,25
CP72-8	28 × 1"	RZ-LG	100	3130,25
CP72-9	35 × 1 1/4"	RZ-LG	100	4503,25
CP72-10	42 × 1 1/2"	RZ-LG	100	6359,25

CP72-11	6 × 1/4"	RZ-SG	630	791,75
CP72-12	8 × 1/4"	RZ-SG	630	826,25
CP72-13	10 × 3/8"	RZ-SG	630	963,75
CP72-14	12 × 3/8"	RZ-SG	630	1032,25
CP72-15	14 × 1/2"	RZ-SG	630	1170,25
CP72-16	16 × 1/2"	RZ-SG	400	1410,25
CP72-17	20 × 3/4"	RZ-SG	400	2234,25
CP72-18	25 × 1"	RZ-SG	400	2853,25
CP72-19	30 × 1 1/4"	RZ-SG	400	4126,25
CP72-20	38 × 1 1/2"	RZ-SG	400	5570,25

Leveringstid Ring

Gleitmo smørepasta



Varenr.	Vol.	DKK
CP100-2	100 g	468,50

Omløber skærering

AISI 316 - MM



Varenr.	ø × MM	Type	DKK
CP63-1	4 × M8*1	ÜWM-LL	29,00
CP63-2	6 × M10*1	ÜWM-LL	32,70
CP63-3	8 × M12*1	ÜWM-LL	36,90
CP63-4	6 × M12*1,5	ÜWM-L	23,45
CP63-5	8 × M14*1,5	ÜWM-L	28,70
CP63-6	10 × M16*1,5	ÜWM-L	32,40
CP63-7	12 × M18*1,5	ÜWM-L	37,70
CP63-8	15 × M22*1,5	ÜWM-L	50,90
CP63-9	18 × M26*1,5	ÜWM-L	96,10
CP63-10	22 × M30*2	ÜWM-L	116,25
CP63-11	28 × M36*2	ÜWM-L	165,25
CP63-12	35 × M45*2	ÜWM-L	233,75
CP63-13	42 × M52*2	ÜWM-L	311,50
CP63-14	6 × M14*1,5	ÜWM-S	29,90
CP63-15	8 × M16*1,5	ÜWM-S	33,75
CP63-16	10 × M18*1,5	ÜWM-S	40,25
CP63-17	12 × M20*1,5	ÜWM-S	45,05
CP63-18	14 × M22*1,5	ÜWM-S	56,25
CP63-19	16 × M24*1,5	ÜWM-S	92,00
CP63-20	20 × M30*2	ÜWM-S	121,25
CP63-21	25 × M36*2	ÜWM-S	215,75
CP63-22	30 × M42*2	ÜWM-S	267,50
CP63-23	38 × M52*2	ÜWM-S	376,00

Leveringstid Ring

Skærering

AISI 316



Varenr.	ø	Type	DKK
CP62-1	4	SR-LL	12,55
CP62-2	6	SR-LL	15,30
CP62-3	8	SR-LL	18,95
CP62-4	6	SR-L	14,85
CP62-5	8	SR-L	17,65
CP62-6	10	SR-L	24,95
CP62-7	12	SR-L	28,15
CP62-8	15	SR-L	34,30
CP62-9	18	SR-L	37,70
CP62-10	22	SR-L	42,20
CP62-11	28	SR-L	64,95
CP62-12	35	SR-L	91,20
CP62-13	42	SR-L	104,00
CP62-14	6	SR-S	14,85
CP62-15	8	SR-S	17,65
CP62-16	10	SR-S	24,95
CP62-17	12	SR-S	28,15
CP62-18	14	SR-S	32,70
CP62-19	16	SR-S	34,30
CP62-20	20	SR-S	40,55
CP62-21	25	SR-S	62,30
CP62-22	30	SR-S	87,10
CP62-23	38	SR-S	92,85

Leveringstid Ring

Støttebøsning

AISI 316



Varenr.	Ø	Type	DKK
CP59-1	4	VSHÜ	23,75
CP59-2	5	VSHÜ	25,30
CP59-3	6	VSHÜ	27,40
CP59-4	7	VSHÜ	29,00
CP59-5	8	VSHÜ	30,15
CP59-6	9	VSHÜ	30,70
CP59-7	10	VSHÜ	30,70
CP59-8	11	VSHÜ	32,40
CP59-9	12	VSHÜ	33,25
CP59-10	13	VSHÜ	33,25
CP59-11	14	VSHÜ	37,70
CP59-12	15	VSHÜ	40,85
CP59-13	16	VSHÜ	40,85
CP59-14	17	VSHÜ	50,90
CP59-15	18	VSHÜ	50,90
CP59-16	19	VSHÜ	60,90
CP59-17	20	VSHÜ	66,60
CP59-18	22	VSHÜ	86,80
CP59-19	23	VSHÜ	96,10
CP59-20	24	VSHÜ	92,55
CP59-21	25	VSHÜ	92,55
CP59-22	26	VSHÜ	94,20
CP59-23	30	VSHÜ	105,50
CP59-24	31	VSHÜ	97,00
CP59-25	32	VSHÜ	103,50
CP59-26	33	VSHÜ	101,00
CP59-27	38	VSHÜ	114,75

Skærering pakning

VITON



Varenr.	Dim	DKK
CP61-1	1/8"	26,25
CP61-2	1/4"	26,25
CP61-3	3/8"	26,25
CP61-4	1/2"	26,25
CP61-5	3/4"	39,70
CP61-6	1"	39,70
CP61-7	1 1/4"	52,65
CP61-8	1 1/2"	52,65



468

Bonded seal pakning

NBR / AISI 316



Varenr.	∅	DKK
C51-1	8	36,35
C51-2	10	¤
C51-3	12	50,10
C51-4	14	41,45
C51-5	16	43,10
C51-6	18	52,40
C51-7	20	¤
C51-8	22	57,90
C51-9	24	¤
C51-10	26	¤
C51-11	30	¤
C51-12	32	¤
C51-13	36	¤
C51-14	42	¤

¤ = spørg på pris

Bonded seal pakning

NBR / AISI 316



Varenr.	dim	DKK
C50-1	1/8"	25,55
C50-2	1/4"	31,00
C50-3	3/8"	40,25
C50-4	1/2"	45,55
C50-5	3/4"	68,25
C50-6	1"	101,75
C50-7	1 1/4"	226,50
C50-8	1 1/2"	¤
C50-9	2"	¤

¤ = spørg på pris

GEVINDFITTINGS RUSTFRI AISI 316 HØJTRYK



Passer til skæreringsfittings



316: -20°C +400°C. NBR: -35°C +100°C.
FPM: -20°C +200°C. PTFE: -60°C +200°C



Kan leveres med 3.1
certifikat

Rustfri syrefast højtryk rørgvind fittings, der passer til rustfri syrefast skæreringsfittings. Denne serie giver mange kombinationsmuligheder med hensyn til montering.

Brystnippel højtryk

AISI 316 - BSPT



Varenr.	BSPT	bar	DKK
CP86-2	1/4"	400	110,25
CP86-3	3/8"	400	119,75
CP86-4	1/2"	400	174,00
CP86-5	3/4"	400	239,50
CP86-6	1"	400	329,50
CP86-7	1 1/4"	200	682,75
CP86-8	1 1/2"	200	879,75
CP86-9	2"	100	1153,75

Svejsenippel højtryk

AISI 316 - BSPP



60° konus i BSPP-enden

Varenr.	dim	bar	DKK
CP137-1	1/8"	400	103,00
CP137-2	1/4"	400	84,40
CP137-3	3/8"	400	107,75
CP137-4	1/2"	400	136,25
CP137-5	3/4"	400	259,00
CP137-6	1"	400	382,50
CP137-7	1 1/4"	200	625,75
CP137-8	1 1/2"	200	932,50
CP137-9	2"	100	1292,75

Brystnippel højtryk red.

AISI 316 - BSPT×BSPP



60° konus i BSPP-enden

Varenr.	BSPT × BSPP	bar	DKK
CP131-2-1	1/8" × 1/4"	400	200,50
CP131-1-2	1/4" × 1/8"	400	178,00
CP131-3-2	1/4" × 3/8"	400	201,50
CP131-4-2	1/4" × 1/2"	400	353,00
CP131-5-2	1/4" × 3/4"	400	413,50
CP131-2-3	3/8" × 1/4"	400	160,25
CP131-4-3	3/8" × 1/2"	400	237,00
CP131-5-3	3/8" × 3/4"	400	320,00
CP131-2-4	1/2" × 1/4"	400	196,50
CP131-3-4	1/2" × 3/8"	400	195,25
CP131-5-4	1/2" × 3/4"	400	283,25
CP131-2-5	3/4" × 1/4"	400	350,25
CP131-3-5	3/4" × 3/8"	400	330,50
CP131-4-5	3/4" × 1/2"	400	353,00
CP131-4s-5	3/4" × 5/8"	400	298,25
CP131-6-5	3/4" × 1"	400	504,00
CP131-4-6	1" × 1/2"	400	¤
CP131-5-6	1" × 3/4"	400	454,75
CP131-7-6	1" × 1 1/4"	200	1038,25
CP131-6-7	1 1/4" × 1"	200	817,00
CP131-7-8	1 1/2" × 1 1/4"	200	1162,00
CP131-8-7	1 1/4" × 1 1/2"	200	1362,75
CP131-8-9	2" × 1 1/2"	100	1569,75

¤ = spørg på pris

Brystnippel højtryk

AISI 316 - NPT



Varenr.	NPT	bar	DKK
CP85-2	1/4"	630	116,50
CP85-3	3/8"	630	161,75
CP85-4	1/2"	630	184,75
CP85-5	3/4"	630	251,75
CP85-6	1"	400	358,50
CP85-7	1 1/4"	400	694,50
CP85-8	1 1/2"	400	905,00
CP85-9	2"	315	1195,00

Brystnippel højtryk

AISI 316 - BSPP×BSPT



60° konus i BSPP-enden

Varenr.	BSPP × BSPT	bar	DKK
CP82-1	1/8"	400	145,75
CP82-2	1/4"	400	130,25
CP82-3	3/8"	400	156,50
CP82-4	1/2"	400	175,50
CP82-5	3/4"	400	237,50
CP82-6	1"	400	369,00
CP82-7	1 1/4"	200	687,00
CP82-8	1 1/2"	200	757,25
CP82-9	2"	100	1116,75

Brystnippel højtryk

AISI 316 - BSPP



60° konus i begge ender

Varenr.	BSPP	bar	DKK
CP130-1	1/8"	400	124,00
CP130-2	1/4"	400	94,20
CP130-3	3/8"	400	111,50
CP130-4	1/2"	400	151,25
CP130-4s	5/8"	400	218,00
CP130-5	3/4"	400	176,50
CP130-6	1"	400	299,00
CP130-7	1 1/4"	200	511,25
CP130-8	1 1/2"	200	666,75
CP130-9	2"	100	839,50

Brystnippel højtryk red.

AISI 316 - BSPP



60° konus i begge ender

Varenr.	BSPP	bar	DKK
CP83-1-2	1/4" x 1/8"	400	134,25
CP83-2-3	3/8" x 1/4"	400	127,00
CP83-2-4	1/2" x 1/4"	400	178,75
CP83-3-4	1/2" x 3/8"	400	164,25
CP83-3-5	3/4" x 3/8"	400	265,75
CP83-4-5	3/4" x 1/2"	400	215,75
CP83-4-6	1" x 1/2"	400	418,00
CP83-4s-4	5/8" x 1/2"	400	278,50
CP83-4s-5	3/4" x 5/8"	400	367,00
CP83-5-6	1" x 3/4"	400	357,25
CP83-5-7	1 1/4" x 3/4"	200	643,75
CP83-6-7	1 1/4" x 1"	200	551,25
CP83-6-8	1 1/2" x 1"	200	689,75
CP83-7-8	1 1/2" x 1 1/4"	200	570,75
CP83-7-9	2" x 1 1/4"	100	1151,75
CP83-8-9	2" x 1 1/2"	100	931,50

Brystnippel højtryk

AISI 316 - BSPP x NPT



60° konus i BSPP-enden

Varenr.	BSPP x NPT	bar	DKK
CP84-1	1/8"	400	143,00
CP84-2	1/4"	400	128,00
CP84-3	3/8"	400	154,50
CP84-4	1/2"	400	171,50
CP84-5	3/4"	400	233,75
CP84-6	1"	400	363,25
CP84-7	1 1/4"	200	674,00
CP84-8	1 1/2"	200	743,50
CP84-9	2"	100	1094,00

Brystnippel højtryk red.

AISI 316 - BSPP x NPT



60° konus i BSPP-enden

Varenr.	BSPP x NPT	bar	DKK
CP132-1-2	1/8" x 1/4"	400	182,50
CP132-2-1	1/4" x 1/8"	400	182,50
CP132-2-3	1/4" x 3/8"	400	153,50
CP132-2-4	1/4" x 1/2"	400	209,00
CP132-3-2	3/8" x 1/4"	400	184,75
CP132-3-4	3/8" x 1/2"	400	187,00
CP132-3-5	3/8" x 3/4"	400	336,75
CP132-4-3	1/2" x 3/8"	400	199,50
CP132-4-5	1/2" x 3/4"	400	328,00
CP132-4s-5	5/8" x 3/4"	400	328,00
CP132-5-2	3/4" x 1/4"	400	355,00
CP132-5-3	3/4" x 3/8"	400	285,75
CP132-5-4	3/4" x 1/2"	400	340,25
CP132-5-6	3/4" x 1"	400	438,75
CP132-5-7	3/4" x 1 1/4"	200	□
CP132-5-8	3/4" x 1 1/2"	200	1244,25
CP132-6-5	1" x 3/4"	400	502,25
CP132-6-7	1" x 1 1/4"	200	782,50
CP132-7-6	1 1/4" x 1"	200	828,75
CP132-7-8	1 1/4" x 1 1/2"	200	1142,50
CP132-8-7	1 1/2" x 1 1/4"	200	1072,25
CP132-8-9	1 1/2" x 2"	100	1519,25
CP132-9-8	2" x 1 1/2"	100	991,50

□ = spørg på pris

Forlænger højtryk

AISI 316 - BSPP



60° konus i nippelenden

Varenr.	BSPP	bar	DKK
CP133-1	1/8"	630	208,00
CP133-2	1/4"	630	190,25
CP133-3	3/8"	400	209,00
CP133-4	1/2"	400	235,00
CP133-5	3/4"	400	289,75
CP133-6	1"	400	425,25
CP133-7	1 1/4"	250	838,25
CP133-8	1 1/2"	250	1105,25
CP133-9	2"	100	1575,00

Spidsmuffe højtryk

AISI 316 - BSPP x BSPT



60° konus i nippelenden

Varenr.	BSPP x BSPT	bar	DKK
CP134-2-1	1/8" x 1/4"	630	202,75
CP134-1-2	1/4" x 1/8"	630	224,75
CP134-3-2	1/4" x 3/8"	630	253,00
CP134-4-2	1/4" x 1/2"	630	299,00
CP134-1-3	3/8" x 1/8"	630	224,75
CP134-2-3	3/8" x 1/4"	400	250,75
CP134-4-3	3/8" x 1/2"	400	237,25
CP134-5-3	3/8" x 3/4"	400	422,75
CP134-2-4	1/2" x 1/4"	630	335,75
CP134-3-4	1/2" x 3/8"	400	314,00
CP134-5-4	1/2" x 3/4"	400	422,75
CP134-4-5	3/4" x 1/2"	400	519,00
CP134-6-5	3/4" x 1"	400	492,75
CP134-5-6	1" x 3/4"	400	481,25
CP134-7-6	1" x 1 1/4"	250	905,00
CP134-6-7	1 1/4" x 1"	250	896,25
CP134-8-7	1 1/4" x 1 1/2"	250	1273,25
CP134-9-8	1 1/2" x 2"	250	1862,25
CP134-8-9	2" x 1 1/2"	100	1702,75

Nippelmuffe højtryk

AISI 316 - BSPP



60° konus i nippelenden

Varenr.	BSPT × BSPP	bar	DKK
CP138-2-1	1/4" × 1/8"	400	267,50
CP138-3-1	3/8" × 1/8"	400	177,50
CP138-3-2	3/8" × 1/4"	400	199,50
CP138-4-2	1/2" × 1/4"	400	253,00
CP138-4-3	1/2" × 3/8"	400	284,00
CP138-5-4	3/4" × 1/2"	400	296,50
CP138-6-5	1" × 3/4"	400	391,50
CP138-7-5	1 1/4" × 3/4"	250	670,25
CP138-7-6	1 1/4" × 1"	250	670,25
CP138-8-6	1 1/2" × 1"	250	1263,00
CP138-9-6	2" × 1"	250	1654,25
CP138-9-7	2" × 1 1/4"	250	777,25
CP138-9-8	2" × 1 1/2"	250	1951,00

α = spørg på pris

Nippelmuffe

AISI 316 - NPT × BSPP



Varenr.	NPT × BSPP	bar	DKK
B47-3	1/4" × 1/4"	400	406,00
B47-6	1/4" × 1/2"	400	406,00
B47-4	3/8" × 1/4"	400	406,00
B47-7	3/8" × 1/2"	400	406,00
B47-8	1/2" × 1/2"	400	406,00
B47-9	3/4" × 1/2"	400	547,00

Muffe højtryk

AISI 316 - BSPP



Varenr.	BSPP	bar	DKK
CP93-2	1/4"	630	135,25
CP93-3	3/8"	630	167,50
CP93-4	1/2"	400	208,00
CP93-5	3/4"	400	293,25
CP93-6	1"	400	422,75
CP93-7	1 1/4"	315	1026,50
CP93-8	1 1/2"	315	1238,25

Prop sekskant højtryk

AISI 316 - BSPP



Med 60° konus

Varenr.	BSPP	bar	DKK
CP139-1	1/8"	400	71,00
CP139-2	1/4"	400	78,35
CP139-3	3/8"	400	94,20
CP139-4	1/2"	400	122,25
CP139-5	3/4"	400	194,75
CP139-6	1"	400	259,00
CP139-7	1 1/4"	200	406,75
CP139-8	1 1/2"	200	616,50
CP139-9	2"	100	749,25

Prop højtryk Unbrako

AISI 316 / VITON - BSPP

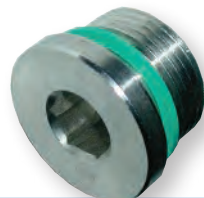

Varenr.	BSPP	DKK
CP58-1	1/8"	90,90
CP58-2	1/4"	121,50
CP58-3	3/8"	198,25
CP58-4	1/2"	260,00
CP58-5	3/4"	415,75
CP58-6	1"	511,25

Prop højtryk Unbrako

AISI 316 / NBR - MM



Varenr.	MM	DKK
CP57-1	M10*1	α
CP57-2	M12*1,5	134,25
CP57-3	M14*1,5	102,25
CP57-4	M16*1,5	135,25
CP57-5	M18*1,5	136,25
CP57-6	M20*1,5	190,00
CP57-7	M22*1,5	215,25
CP57-8	M26*1,5	α
CP57-9	M27*2	α
CP57-10	M33*2	α
CP57-11	M42*2	α
CP57-12	M48*2	543,00

α = spørg på pris

Slutmuffe højtryk

AISI 316 - BSPP

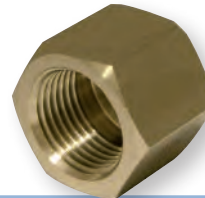

Varenr.	BSPP	bar	DKK
CP135-2	1/4"	400	125,00
CP135-3	3/8"	400	160,25
CP135-4	1/2"	400	187,00
CP135-5	3/4"	400	243,00
CP135-6	1"	400	303,00
CP135-7	1 1/4"	200	431,75
CP135-8	1 1/2"	200	640,25
CP135-9	2"	100	782,50

Kontramøtrik højtryk

AISI 316 - BSPP



Varenr.	BSPP	DKK
CP140-2	1/4"	48,75
CP140-3	3/8"	66,60
CP140-4	1/2"	72,65
CP140-5	3/4"	110,25
CP140-6	1"	142,00

Skotgennemføring højtryk

AISI 316 - BSPP



60° konus i begge ender

Varenr.	BSPP	Ext. dim	bar	DKK
CP92-2	1/4"	14	400	184,75
CP92-3	3/8"	18	400	206,75
CP92-4	1/2"	22	400	251,75
CP92-5	3/4"	27	400	393,75
CP92-6	1"	34	400	651,75

Vinkel 90° højtryk muf/muf

AISI 316 - BSPP



Varenr.	BSPP	bar	DKK
CP157-1	1/8"	400	367,75
CP157-2	1/4"	400	367,75
CP157-3	3/8"	400	481,25
CP157-4	1/2"	400	614,25
CP157-5	3/4"	400	698,75
CP157-6	1"	400	836,50
CP157-7	1 1/4"	200	2245,50

Vinkel 90° højtryk nippel/nippel

AISI 316 - BSPP

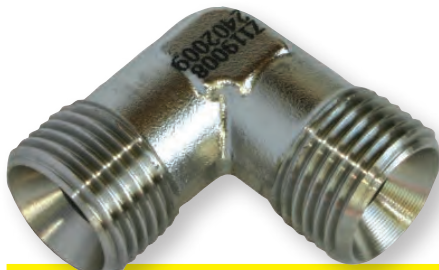

60° konus i begge ender

Varenr.	BSPP	bar	DKK
CP145-1	1/8"	400	304,00
CP145-2	1/4"	400	308,25
CP145-3	3/8"	400	327,00
CP145-4	1/2"	400	405,75
CP145-5	3/4"	400	668,00
CP145-6	1"	400	784,50
CP145-7	1 1/4"	200	1379,25
CP145-8	1 1/2"	200	2983,00

T-stk højtryk m. muffer

AISI 316 - BSPP



Varenr.	BSPP	bar	DKK
CP149-2	1/4"	400	543,00
CP149-3	3/8"	400	656,75
CP149-4	1/2"	400	909,50
CP149-5	3/4"	400	1145,50
CP149-6	1"	400	1335,00

T-stk højtryk m. nipler

AISI 316 - BSPP



Varenr.	BSPP	bar	DKK
CP90-2	1/4"	400	406,75
CP90-3	3/8"	400	492,75
CP90-4	1/2"	400	550,25
CP90-5	3/4"	400	838,25
CP90-6	1"	400	1172,25
CP90-7	1 1/4"	200	1617,25

60° konus i alle ender

Varenr.	BSPP	bar	DKK
CP90-2	1/4"	400	406,75
CP90-3	3/8"	400	492,75
CP90-4	1/2"	400	550,25
CP90-5	3/4"	400	838,25
CP90-6	1"	400	1172,25
CP90-7	1 1/4"	200	1617,25

Forlængersvivel højtryk

AISI 316 - BSPP



60° konus i nippelenden

Varenr.	BSPP	bar	DKK
CP91-2	1/4"	400	171,50
CP91-3	3/8"	400	209,00
CP91-4	1/2"	400	277,25
CP91-5	3/4"	400	350,50
CP91-6	1"	400	625,75
CP91-7	1 1/4"	200	1038,25
CP91-8	1 1/2"	200	1286,50
CP91-9	2"	100	⌘

⌘ = spørg på pris

Nippelmuffe højtryk svivel

AISI 316 - BSPP



60° konus i nippelenden

Varenr.	BSPP × BSPT	bar	DKK
CP144-1-2	1/4" × 1/8"	400	171,50
CP144-2-1	1/8" × 1/4"	400	176,00
CP144-2-3	3/8" × 1/4"	400	222,25
CP144-3-2	1/4" × 3/8"	400	232,50
CP144-3-4	1/2" × 3/8"	400	269,00
CP144-4-3	3/8" × 1/2"	400	332,00
CP144-4-5	3/4" × 1/2"	400	398,75
CP144-5-4	1/2" × 3/4"	400	522,50
CP144-5-6	1" × 3/4"	400	684,00
CP144-6-5	3/4" × 1"	400	891,25
CP144-6-7	1 1/4" × 1"	200	1182,50
CP144-7-6	1" × 1 1/4"	200	⌘
CP144-7-8	1 1/2" × 1 1/4"	200	1480,25
CP144-8-7	1 1/4" × 1 1/2"	200	⌘
CP144-8-9	2" × 1 1/2"	100	⌘
CP144-9-8	1 1/2" × 2"	100	⌘

⌘ = spørg på pris

Muffe højtryk svivel

AISI 316 - BSPP



Varenr.	BSPP	bar	DKK
CP142-2	1/4"	400	244,25
CP142-3	3/8"	400	281,75
CP142-4	1/2"	400	300,00
CP142-5	3/4"	400	435,25
CP142-6	1"	400	715,25

Vinkel 90° højtryk nippel/ muffe

AISI 316 - BSPP



Nippel m. 60° konus, muffe m. svivel

Varenr.	BSPP	bar	DKK
CP146-1	1/8"	400	359,75
CP146-2	1/4"	400	361,00
CP146-3	3/8"	400	408,25
CP146-4	1/2"	400	482,50
CP146-5	3/4"	400	850,50
CP146-6	1"	400	1065,25
CP146-7	1 1/4"	200	1303,00

T-stk højtryk muf/nip/nip

AISI 316 - BSPP



Nipler m. 60° konus, muffe m. svivel

Varenr.	BSPP	bar	DKK
CP152-2	1/4"	400	524,75
CP152-3	3/8"	400	564,75
CP152-4	1/2"	400	682,75
CP152-5	3/4"	400	1045,50
CP152-6	1"	400	1486,50
CP152-7	1 1/4"	200	1939,50

Vinkel 90° højtryk svivel

AISI 316 - BSPP



Varenr.	BSPP	bar	DKK
CP147-2	1/4"	400	527,25
CP147-3	3/8"	400	505,00
CP147-4	1/2"	400	691,00
CP147-5	3/4"	400	932,50
CP147-6	1"	400	1403,00
CP147-7	1 1/4"	200	2428,75

T-stk højtryk muffe svivler

AISI 316 - BSPP



Varenr.	BSPP	bar	DKK
CP148-2	1/4"	400	678,00
CP148-3	3/8"	400	725,00
CP148-4	1/2"	400	926,00
CP148-5	3/4"	400	1381,25
CP148-6	1"	400	1774,75

T-stk højtryk nip/muf svivel/nip

AISI 316 - BSPP



Nipler m. 60° konus

Varenr.	BSPP	bar	DKK
CP97-2	1/4"	400	524,75
CP97-3	3/8"	400	564,75
CP97-4	1/2"	400	682,75
CP97-5	3/4"	400	1045,50
CP97-6	1"	400	1486,50
CP97-7	1 1/4"	200	1939,50

Slutmuffe højtryk

AISI 316 - BSPP



Varenr.	BSPP	DKK
CP136-2	1/4"	130,50
CP136-3	3/8"	136,25
CP136-4	1/2"	145,50
CP136-5	3/4"	228,75
CP136-6	1"	354,00
CP136-7	1 1/4"	565,75
CP136-8	1 1/2"	919,50
CP136-9	2"	1551,25

Bøjning 90° højtryk nip/muf

AISI 316 - BSPP



Nippel m. 60° konus, muffe m. svivel

Varenr.	BSPP	DKK
CP153-2	1/4"	350,50
CP153-3	3/8"	402,25
CP153-4	1/2"	482,50
CP153-5	3/4"	655,75
CP153-6	1"	930,50
CP153-7	1 1/4"	2611,25
CP153-8	1 1/2"	3176,75
CP153-9	2"	6462,25

Bøjning 45° højtryk nip/muf

AISI 316 - BSPP



Nippel m. 60° konus, muffe m. svivel

Varenr.	BSPP	DKK
CP154-2	1/4"	350,50
CP154-3	3/8"	402,25
CP154-4	1/2"	482,50
CP154-5	3/4"	655,75
CP154-6	1"	930,50
CP154-7	1 1/4"	2611,25
CP154-8	1 1/2"	3176,75
CP154-9	2"	6462,25

Bøjning 90° højtryk muf/muf

AISI 316 - BSPP



Med svivelfunktion

Varenr.	BSPP	DKK
CP155-2	1/4"	402,25
CP155-3	3/8"	463,00
CP155-4	1/2"	555,25
CP155-5	3/4"	754,00
CP155-6	1"	1070,25
CP155-7	1 1/4"	3005,75

KLEMRINGSFITTINGS AISI 316 TIL METRISKE RØR



Afhængig af rørtype



-20°C til +225°C



Serien udmærker sig ved nem og hurtig montage. Serien kan bruges til mange forskellige rørtyper, dog skal røret være kalibreret.

Max tryk indv. gevind: 1/8": 420 bar, 1/4": 427 bar, 3/8": 344 bar, 1/2": 312 bar, 3/4": 303 bar, 1": 337 bar

Max. tryk udv. gevind: 1/8": 661 bar, 1/4": 523 bar, 3/8": 413 bar, 1/2": 422 bar, 3/4": 344 bar, 1": 344 bar

MONTAGEVEJLEDNING

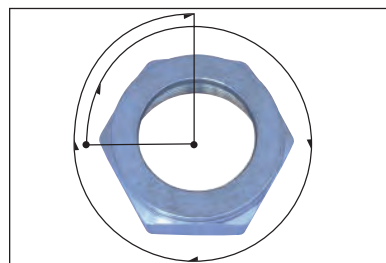
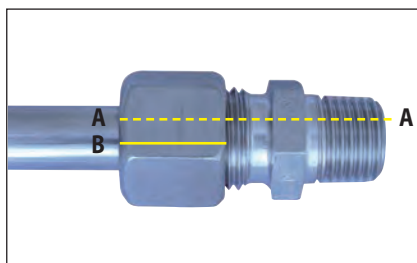
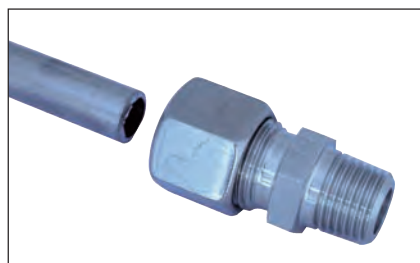

1. Vores fittings sælges komplet monteret, parat til øjeblikkelig brug ved blot at skyde røret ind i fittingsdelen. Husk at røret skal helt i bund.

For at kunne genbruge klemringsfittings max. antal gange, skal denne afmonteringsprocedure følges nøje: Mærk både fittingskrop og omløber. Ved genmontering tilspændes med hånden, derefter med fastnøgle til tidligere position. Derefter tilspændes endnu et nøk (1/2 sekskantsflade) fra position A til B, forbi den seneste afmærkning.

Størrelse 6mm til 25mm
1-1/4 omgang med fastnøgle efter finger tilspænding.

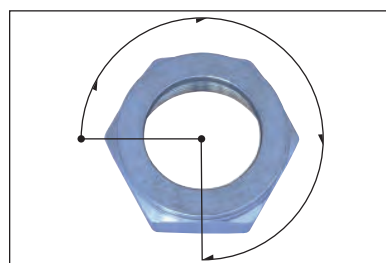
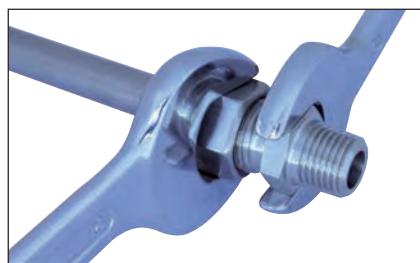

2. Spænd omløber med fingrene. Tag derefter en fastnøgle og spænd det beskrevne antal omgange. Hold fittingskroppen med en fastnøgle for at hindre fittingskroppen i at dreje. Marker omløberen, så du sikrer dig korrekt tilspænding.

Størrelse 3mm til 4mm
Kun 3/4 omgang med fastnøgle efter finger tilspænding.



Unilok certifikat

Svejst kalibreret rør 2m

AISI 316



Varenr.	Ø	- -	DKK
BK35-0	4	1	218,50
BK35-1	6	1	227,25
BK35-2	8	1	279,50
BK35-3	10	1	349,50
BK35-4	12	1	419,25

Sælges kun i hele længder

Svejst kalibreret rør 6m

AISI 316

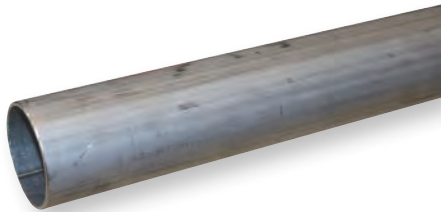

Varenr.	Ø	- -	DKK
B36-0	4	1	770,50
B36-1	6	1	321,25
B36-2	8	1	413,00
B36-3	10	1	499,25
B36-4	12	1	573,25
B36-5	15	1	692,25
B36-11-1	16	1	769,75
B36-6-2	18	1.5	923,00
B36-7-1	20	2	1264,00
B36-7	22	2	1589,50
B36-9-1	28	2	1906,75

Sælges kun i hele længder

Nippel klemring

AISI 316 - BSPT



Varenr.	Ø × BSPT	DKK
C1-01	3 × 1/8"	151,25
C1-02	4 × 1/8"	151,25
C1-1	6 × 1/8"	137,25
C1-2	6 × 1/4"	140,00
C1-3	6 × 3/8"	154,50
C1-4	6 × 1/2"	175,50
C1-5	8 × 1/8"	155,75
C1-6	8 × 1/4"	154,50
C1-7	8 × 3/8"	161,75
C1-8	8 × 1/2"	187,00
C1-9	10 × 1/8"	170,25
C1-10	10 × 1/4"	170,25
C1-11	10 × 3/8"	172,75
C1-12	10 × 1/2"	183,50
C1-13	12 × 1/4"	198,25
C1-14	12 × 3/8"	201,50
C1-15	12 × 1/2"	215,25
C1-16	12 × 3/4"	329,50
C1-17	15 × 1/2"	322,00
C1-18	16 × 1/2"	347,75
C1-19	16 × 3/4"	347,75
C1-20	18 × 1/2"	426,50
C1-21	18 × 3/4"	426,50
C1-22	20 × 1/2"	501,75
C1-23	20 × 3/4"	501,75
C1-24	20 × 1"	501,75
C1-25	22 × 1/2"	569,75
C1-26	22 × 3/4"	569,75
C1-27	22 × 1"	646,50
C1-28	25 × 1"	646,50

Nippel klemring

AISI 316 - BSPP



Varenr.	Ø × BSPP	DKK
C2-01	3 × 1/8"	132,25
C2-02	4 × 1/8"	132,25
C2-1	6 × 1/8"	137,25
C2-2	6 × 1/4"	140,00
C2-3	6 × 3/8"	154,50
C2-4	6 × 1/2"	175,50
C2-5	8 × 1/8"	155,75
C2-6	8 × 1/4"	154,50
C2-7	8 × 3/8"	161,75
C2-8	8 × 1/2"	187,00
C2-9	10 × 1/8"	170,25
C2-10	10 × 1/4"	170,25
C2-11	10 × 3/8"	172,75
C2-12	10 × 1/2"	183,50
C2-13	12 × 1/4"	198,25
C2-14	12 × 3/8"	201,50
C2-15	12 × 1/2"	215,25
C2-16	12 × 3/4"	329,50
C2-17	15 × 1/2"	322,00
C2-18	16 × 1/2"	347,75
C2-19	16 × 3/4"	347,75
C2-20	18 × 1/2"	434,00
C2-21	18 × 3/4"	398,75
C2-22	20 × 1/2"	501,75
C2-23	20 × 3/4"	501,75
C2-26	22 × 3/4"	533,00
C2-27	22 × 1"	646,50
C2-28-1	25 × 3/4"	1162,00
C2-28	25 × 1"	1162,00

Nippel klemring

AISI 316 - NPT



Varenr.	∅ × NPT	DKK
C3-1-2	3 × 1/4"	201,50
C3-1	6 × 1/8"	137,25
C3-2	6 × 1/4"	141,00
C3-3	6 × 3/8"	¤
C3-4	6 × 1/2"	175,50
C3-5	8 × 1/8"	¤
C3-6	8 × 1/4"	153,50
C3-7	8 × 3/8"	208,00
C3-8	8 × 1/2"	187,00
C3-9	10 × 1/8"	¤
C3-10	10 × 1/4"	171,50
C3-11	10 × 3/8"	172,75
C3-12	10 × 1/2"	183,50
C3-13	12 × 1/4"	198,25
C3-14	12 × 3/8"	201,50
C3-15	12 × 1/2"	211,00
C3-16	12 × 3/4"	304,00
C3-17	15 × 1/2"	423,75
C3-18-2	16 × 1/2"	411,25
C3-19	16 × 3/4"	408,75
C3-20	18 × 1/2"	¤
C3-21	18 × 3/4"	349,25
C3-22	20 × 1/2"	¤
C3-23	20 × 3/4"	423,75
C3-26	22 × 3/4"	¤
C3-27	22 × 1"	¤
C3-28-1	25 × 3/4"	¤
C3-28	25 × 1"	646,50

¤ = spørg på pris

Muffe klemring

AISI 316 - BSPP



Varenr.	∅ × BSPP	DKK
C4-01	3 × 1/8"	171,00
C4-02	4 × 1/8"	164,25
C4-1	6 × 1/8"	149,75
C4-2	6 × 1/4"	155,75
C4-3	6 × 3/8"	167,50
C4-4	6 × 1/2"	204,25
C4-5	8 × 1/8"	260,00
C4-6	8 × 1/4"	165,25
C4-7	8 × 3/8"	231,00
C4-8	8 × 1/2"	202,75
C4-9	10 × 1/8"	231,00
C4-10	10 × 1/4"	172,75
C4-11	10 × 3/8"	180,00
C4-12	10 × 1/2"	210,00
C4-13	12 × 1/4"	188,50
C4-14	12 × 3/8"	209,00
C4-15	12 × 1/2"	243,00
C4-17	15 × 1/2"	435,25
C4-18	16 × 1/2"	334,00
C4-22	20 × 1/2"	434,00
C4-26	22 × 3/4"	613,25
C4-28	25 × 1"	670,25

Muffe klemring

AISI 316 - NPT



Varenr.	∅ × NPT	DKK
C6-1	6 × 1/8"	236,25
C6-2	6 × 1/4"	163,00
C6-3	6 × 3/8"	¤
C6-4	6 × 1/2"	329,75
C6-5	8 × 1/8"	¤
C6-6	8 × 1/4"	193,75
C6-7	8 × 3/8"	227,00
C6-8	8 × 1/2"	230,00
C6-9	10 × 1/8"	¤
C6-10	10 × 1/4"	359,75
C6-11	10 × 3/8"	268,00
C6-12	10 × 1/2"	245,25
C6-13	12 × 1/4"	215,25
C6-14	12 × 3/8"	227,00
C6-15	12 × 1/2"	293,25

¤ = spørg på pris

Nippel klemring/svejs

AISI 316



Varenr.	∅ × dim	DKK
C13-1	3 × 10,3 ~ 1/8"	135,25
C13-2	4 × 10,3	135,25
C13-3	6 × 10,3	117,75
C13-4	6 × 13,7 ~ 1/4"	112,50
C13-5	8 × 10,3	141,00
C13-6	8 × 13,7	166,50
C13-7	8 × 21,3 ~ 1/2"	215,25
C13-8	10 × 13,7	166,50
C13-9	10 × 17,1 ~ 3/8"	182,50
C13-10	10 × 21,3	249,75
C13-11	12 × 13,7	242,00
C13-12	12 × 17,1	250,75
C13-13	12 × 21,3	245,25
C13-14	15 × 21,3	291,00
C13-15	16 × 21,3	291,00
C13-16	18 × 21,3	343,75

Union klemring

AISI 316



Varenr.	∅	DKK
C7-01	3	196,75
C7-02	4	184,75
C7-1	6	196,75
C7-2	8	227,00
C7-3	10	246,50
C7-4	12	303,00
C7-5	15	345,25
C7-6	16	505,00
C7-7	18	586,75
C7-8	20	586,75
C7-9	22	737,75
C7-10	25	838,25

Union klemring rød

AISI 316

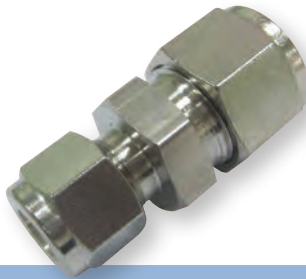

Varenr.	∅	DKK
C8-01	6 × 3	190,25
C8-02	6 × 4	190,25
C8-1	8 × 6	198,25
C8-2	10 × 6	199,50
C8-3	10 × 8	220,00
C8-4	12 × 6	238,25
C8-5	12 × 8	247,50
C8-6	12 × 10	265,75
C8-8	16 × 12	569,75

Skotgennemføring klemring

AISI 316



Varenr.	∅	Ext. dim	DKK
C9-01	3	9	332,00
C9-02	4	10	326,50
C9-1	6	12	250,75
C9-2	8	14	284,00
C9-3	10	17	314,00
C9-4	12	20	378,25
C9-5	15	23	809,25
C9-6	16	23	887,50
C9-7	18	26	932,50

Skotgennemføring klemring

AISI 316



Varenr.	∅ × ∅	Ext. dim	DKK
C103-1	3	8,3	193,00
C103-2	6	11,5	193,00
C103-3	8	13,1	235,75
C103-4	12	19,4	345,50

Vinkel 90° klemring

AISI 316



Varenr.	∅	DKK
C10-01	3	256,75
C10-02	4	241,25
C10-1	6	271,25
C10-2	8	310,50
C10-3	10	324,00
C10-4	12	392,50
C10-5	15	679,25
C10-6	16	651,75
C10-7	18	728,50
C10-8	20	765,50
C10-9	22	1004,25
C10-10	25	910,75

Vinkel 90° klemring/nippel

AISI 316 - BSPT



Varenr.	∅ × BSPT	DKK
C11-01	3 × 1/8"	239,50
C11-02	4 × 1/8"	239,50
C11-1	6 × 1/8"	199,50
C11-2	6 × 1/4"	199,50
C11-6	8 × 1/4"	237,25
C11-7	8 × 3/8"	270,00
C11-10	10 × 1/4"	245,25
C11-11	10 × 3/8"	245,25
C11-12	10 × 1/2"	291,00
C11-13	12 × 1/4"	321,00
C11-14	12 × 3/8"	288,00
C11-15	12 × 1/2"	294,50
C11-18	16 × 1/2"	598,00
C11-19	16 × 3/4"	620,75
C11-20	18 × 1/2"	598,00
C11-22	20 × 1/2"	740,25
C11-26	22 × 3/4"	844,50
C11-28	25 × 1"	935,00

Vinkel 90° klemring/nippel

AISI 316 - NPT



Varenr.	∅ × NPT	DKK
C12-2	6 × 1/4"	212,75
C12-2-1	6 × 1/2"	230,50
C12-6	8 × 1/4"	241,00
C12-10-1	10 × 1/8"	253,25
C12-13	12 × 1/4"	287,00
C12-14	12 × 3/8"	292,75
C12-15	12 × 1/2"	304,00

Vinkel 90° klemring/muffe

AISI 316 - NPT



Varenr.	ø × NPS	DKK
C31-1	6 × 1/8"	334,75
C31-2	6 × 1/4"	380,50
C31-3	6 × 3/8"	471,75
C31-4	6 × 1/2"	635,75
C31-5	8 × 1/8"	215,75
C31-6	8 × 1/4"	392,50
C31-7	8 × 1/2"	362,75
C31-8	10 × 1/8"	394,25
C31-9	10 × 1/4"	448,50
C31-10	10 × 3/8"	467,00
C31-11	10 × 1/2"	659,25
C31-12	12 × 1/4"	588,25
C31-13	12 × 3/8"	620,25
C31-14	12 × 1/2"	728,50
C31-15	16 × 1/2"	736,25

T-stk klemring/nippel gren

AISI 316 - BSPT



Varenr.	ø × BSPT × ø	DKK
C15G-1	6 × 1/8" × 6	358,50
C15G-2	8 × 1/8" × 8	417,00
C15G-3	10 × 1/4" × 10	475,25
C15G-4	12 × 1/2" × 12	649,75
C15G-5	18 × 3/4" × 18	714,00

T-stk klemring/nippel ende

AISI 316 - BSPT



Varenr.	BSPT × ø × ø	DKK
C38-1	1/8" × 3 × 3	¤
C38-2	1/4" × 3 × 3	¤
C38-3	1/8" × 4 × 4	¤
C38-4	1/8" × 6 × 6	346,25
C38-5	1/4" × 6 × 6	417,00
C38-6	1/8" × 8 × 8	426,50
C38-7	1/4" × 8 × 8	443,25
C38-8	1/4" × 10 × 10	¤
C38-9	3/8" × 10 × 10	¤
C38-10	1/4" × 12 × 12	674,00
C38-11	3/8" × 12 × 12	¤
C38-12	1/2" × 12 × 12	719,25
C38-13	3/8" × 16 × 16	¤
C38-14	1/2" × 16 × 16	¤
C38-15	3/4" × 20 × 20	¤

¤ = spørg på pris

T-stk klemring

AISI 316



Varenr.	ø	DKK
C15-01	3	368,75
C15-02	4	394,75
C15-1	6	364,50
C15-2	8	441,00
C15-3	10	441,00
C15-4	12	555,25
C15-5	15	964,75
C15-6	16	895,25
C15-7	18	1039,50
C15-8	20	1061,00
C15-9	22	1321,50
C15-10	25	1321,50

T-stk klemring/muffe gren

AISI 316 - BSPP



Varenr.	ø × BSPP × ø	DKK
C78-1	6 × 1/8" × 6	604,25
C78-2	6 × 1/4" × 6	604,25
C78-3	6 × 3/8" × 6	341,75
C78-4	6 × 1/2" × 6	471,25
C78-5	8 × 1/8" × 8	527,75
C78-6	8 × 1/4" × 8	527,75
C78-7	8 × 3/8" × 8	415,75
C78-8	8 × 1/2" × 8	510,50
C78-9	10 × 1/8" × 10	341,75
C78-10	10 × 1/4" × 10	620,75
C78-11	10 × 3/8" × 10	415,75
C78-12	10 × 1/2" × 10	510,50
C78-13	12 × 1/4" × 12	856,50
C78-14	12 × 3/8" × 12	856,50
C78-15	12 × 1/2" × 12	931,50
C78-16	16 × 1/2" × 16	1048,75
C78-17	20 × 3/4" × 20	1600,75
C78-18	25 × 3/4" × 25	2434,00
C78-19	25 × 1" × 25	2734,75

T-stk klemring/muffe ende

AISI 316 - NPT



Varenr.	NPS × ø × ø	DKK
C76-1	1/8" × 6 × 6	604,25
C76-2	1/4" × 6 × 6	604,25
C76-3	3/8" × 6 × 6	331,75
C76-4	1/2" × 6 × 6	471,25
C76-5	1/8" × 8 × 8	624,75
C76-6	1/4" × 8 × 8	620,75
C76-7	3/8" × 8 × 8	341,75
C76-8	1/2" × 8 × 8	471,25
C76-9	1/8" × 10 × 10	457,50
C76-10	1/4" × 10 × 10	856,50
C76-11	3/8" × 10 × 10	457,50
C76-12	1/2" × 10 × 10	457,50
C76-13	1/4" × 12 × 12	856,50
C76-14	3/8" × 12 × 12	856,50
C76-15	1/2" × 12 × 12	931,50
C76-16	1/2" × 16 × 16	1151,75
C76-17	3/4" × 22 × 22	1554,00

Kryds klemring

AISI 316



Varenr.	∅	DKK
C16-01	3	617,25
C16-02	4	603,25
C16-1	6	645,00
C16-2	8	658,75
C16-3	10	672,75
C16-4	12	812,50

Nippel klemring rørende

AISI 316 - BSPP



Varenr.	∅ × BSPP	DKK
C24-14-1	8 × 1/4"	170,00
C24-14	8 × 3/8"	170,00
C24-23	16 × 3/8"	194,75
C24-24-1	16 × 1/2"	157,25
C24-24	20 × 1/2"	125,00

Nippel klemring/rørende

AISI 316



Varenr.	∅ × ∅	DKK
C17-18	4 × 3	233,75
C17-19	6 × 3	193,75
C17-23	6 × 8	196,25
C17-25	6 × 10	224,25
C17-29	6 × 12	294,00
C17-1	8 × 6	133,00
C17-2	10 × 6	161,75
C17-4	10 × 8	194,75
C17-30	10 × 12	294,00
C17-3	12 × 6	165,25
C17-5	12 × 8	238,25
C17-6	12 × 10	358,50
C17-35	12 × 16	507,75
C17-36	12 × 18	587,25
C17-8	16 × 12	375,75
C17-37	16 × 18	587,25
C17-41	16 × 20	708,75
C17-31	18 × 12	307,75
C17-42	18 × 20	708,75
C17-13	18 × 25	797,00
C17-46	20 × 22	708,75
C17-47	20 × 25	853,75
C17-12	25 × 22	575,50

Nippel klemring rørende

AISI 316 - BSPT



Varenr.	∅ × BSPT	DKK
C52-1	3 × 1/8"	83,80
C52-2	6 × 1/8"	74,80
C52-3	6 × 1/4"	80,55
C52-4	8 × 1/4"	101,25
C52-5	10 × 1/4"	107,50
C52-6	10 × 3/8"	125,00
C52-7	10 × 1/2"	149,75
C52-8	12 × 1/4"	161,75
C52-9	12 × 3/8"	169,25
C52-10	12 × 1/2"	177,50
C52-11	18 × 1/2"	219,00
C52-12	18 × 3/4"	∞
C52-13	28 × 1"	257,50
C52-14	28 × 1 1/4"	612,75
C52-15	32 × 1 1/4"	612,75
C52-16	38 × 1 1/2"	958,00

∞ = spørg på pris

Muffe klemring rørende

AISI 316 - BSPP



Varenr.	∅ × BSPP	DKK
C53-1	3 × 1/8"	101,25
C53-2	6 × 1/8"	107,50
C53-3	6 × 1/4"	131,50
C53-4	8 × 1/4"	131,50
C53-5	10 × 1/4"	136,25
C53-6	10 × 3/8"	199,50
C53-7	10 × 1/2"	235,00
C53-8	12 × 1/4"	182,50
C53-9	12 × 3/8"	194,75
C53-10	12 × 1/2"	263,75
C53-11	18 × 3/4"	217,25

Slutmuffe klemring

AISI 316



Varenr.	∅	DKK
C54-1	3	97,70
C54-2	4	96,10
C54-3	6	84,10
C54-4	8	89,60
C54-5	10	116,50
C54-6	12	169,25
C54-7	15	204,25
C54-8	16	191,25
C54-9	18	262,75
C54-10	20	363,25
C54-11	22	363,25
C54-12	25	509,00

Slutmuffe klemring

AISI 316



Varenr.	ø	DKK
C19-01	3	86,05
C19-02	4	86,05
C19-1	6	131,50
C19-2	8	145,50
C19-3	10	165,25
C19-4	12	193,75
C19-5	15	202,75
C19-6	16	296,50
C19-7	18	277,75
C19-8	20	342,25
C19-9	22	315,00
C19-10	25	313,00

Klemring bageste

AISI 316



Varenr.	ø	DKK
C21-01	3	23,45
C21-02	4	23,45
C21-1	6	16,45
C21-2	8	15,60
C21-3	10	18,00
C21-4	12	24,10
C21-5	15	30,40
C21-6	16	35,20
C21-7	18	38,55
C21-8	20	45,05
C21-9	22	52,65
C21-10	25	44,45

Pakning til udv.

PTFE (TEFLON)



Varenr.	dim	DKK
C5-1	1/8"	19,80
C5-2	1/4"	14,10
C5-3	3/8"	20,75
C5-4	1/2"	21,90
C5-5	3/4"	32,40
C5-6	1"	37,70

Omløber klemring

AISI 316

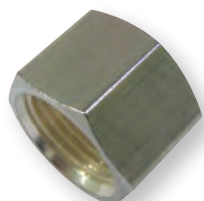

Varenr.	ø	DKK
C20-01	3	41,70
C20-02	4	38,85
C20-1	6	33,50
C20-2	8	38,85
C20-3	10	41,70
C20-4	12	50,35
C20-5	15	83,00
C20-6	16	78,35
C20-7	18	97,45
C20-8	20	107,50
C20-9	22	108,50
C20-10	25	153,50

Klemring forreste

AISI 316



Varenr.	ø	DKK
C22-01	3	23,45
C22-02	4	23,45
C22-1	6	13,10
C22-2	8	14,60
C22-3	10	16,45
C22-4	12	25,85
C22-5	15	32,40
C22-6	16	26,50
C22-7	18	39,15
C22-8	20	41,70
C22-9	22	36,60
C22-10	25	42,20

Pakning til indv. gev.

PTFE (TEFLON)



Varenr.	dim	DKK
C5-2I	1/4"	59,25
C5-3I	3/8"	80,55
C5-4I	1/2"	81,40

KLEMRINGSFITTINGS AISI 316 TIL TOMME RØR



Afhængig af rørtype



-20°C til +225°C



Serien udmærker sig ved nem og hurtig montage. Serien kan bruges til mange forskellige rørtyper, dog skal røret være kalibreret.

Rørmål: 1/8": 3,17mm, 1/4": 6,35mm, 3/8": 9,52mm, 1/2": 12,70mm, 3/4": 19,05mm, 1": 25,40mm

Max. tryk indv. gevind: 1/8": 420bar, 1/4": 427bar, 3/8": 344bar, 1/2": 312bar, 3/4": 303bar, 1": 337bar

Max. tryk udv. gevind: 1/8": 661bar, 1/4": 523bar, 3/8": 413bar, 1/2": 422bar, 3/4": 344bar, 1": 344bar

Størrelser ved klemringsfittings beregnet til rør med tomme (inch) mål:

1/8"	=	3,17 mm
1/4"	=	6,35 mm
3/8"	=	9,52 mm
1/2"	=	12,70 mm
3/4"	=	19,05 mm
1"	=	25,40 mm
1¼"	=	31,75 mm
1½"	=	38,10 mm
2"	=	50,80 mm

Nippel klemring AISI 316 - BSPT



Varenr.	ø × BSPT	DKK
C35-2-1	1/8 × 3/8"	210,00 ₪

₪ = så længe lager haves

Nippel klemring AISI 316 - NPT



Varenr.	ø × NPT	DKK
C36-1	1/8"	147,50
C36-2	1/8" × 1/4"	158,25
C36-2-1	1/8" × 3/8"	186,75
C36-2-2	1/8" × 1/2"	239,50
C36-5	1/4" × 1/8"	142,00
C36-6	1/4"	145,50
C36-7	1/4" × 3/8"	154,50
C36-8	1/4" × 1/2"	180,00
C36-8-1	1/4" × 3/4"	256,00
C36-9	3/8" × 1/8"	175,50
C36-10	3/8" × 1/4"	169,25
C36-11	3/8"	204,25
C36-12	3/8" × 1/2"	155,75
C36-12-1	3/8" × 3/4"	281,25
C36-13	1/2" × 1/8"	200,50
C36-14	1/2" × 1/4"	201,50
C36-15	1/2" × 3/8"	208,00
C36-16	1/2"	200,50
C36-16-1	1/2" × 3/4"	358,50
C36-16-2	1/2" × 1"	443,25
C36-17	3/4" × 1/2"	430,25
C36-18	3/4"	430,25
C36-18-1	3/4" × 1"	586,75
C36-19	1" × 1/2"	613,25
C36-20	1" × 3/4"	604,00
C36-21	1"	586,75

Muffe klemring AISI 316 - NPT



Varenr.	ø × NPT	DKK
C39-1	1/8"	151,25
C39-2	1/8" × 1/4"	183,50
C39-5	1/4" × 1/8"	175,50
C39-6	1/4"	174,00
C39-7	1/4" × 3/8"	213,00
C39-8	1/4" × 1/2"	230,00
C39-9-1	3/8" × 1/8"	193,75
C39-9	3/8" × 1/4"	193,75
C39-10	3/8"	177,50
C39-11	3/8" × 1/2"	210,00
C39-11-1	3/8" × 3/4"	500,75
C39-12	1/2" × 1/4"	201,50
C39-13	1/2" × 3/8"	245,25
C39-14	1/2"	236,25
C39-14-1	1/2" × 3/4"	501,75
C39-15	3/4" × 1/2"	460,50
C39-17	3/4"	529,25
C39-18	1" × 3/4"	598,00
C39-20	1"	713,00



462

Nippel svejs/klemring

AISI 316



Varenr.	ø × Ø	DKK
C46-1	1/8"	122,00
C46-3	1/4"	103,00
C46-5	3/8"	164,25
C46-8	1/2"	222,25
C46-10	3/4"	375,75
C46-11	1"	724,00

Skotgennemføring klemring

AISI 316



Varenr.	ø	Ext. dim	DKK
C42-1	1/8"	9	259,75
C42-3	1/4"	12	264,75
C42-4	3/8"	15	301,25
C42-5	1/2"	20	440,00
C42-6	3/4"	26	856,25
C42-7	1"	34	869,50

Vinkel 90° klemring/nippel

AISI 316 - NPT



Varenr.	ø × NPT	DKK
C45-1	1/8"	235,75
C45-2	1/8" × 1/4"	235,75
C45-10	1/4" × 1/8"	201,50
C45-11	1/4"	273,50
C45-11-1	1/4" × 3/8"	318,25
C45-11-2	1/4" × 1/2"	401,25
C45-12-4	3/8" × 1/8"	306,00
C45-12	3/8" × 1/4"	332,00
C45-13	3/8"	356,00
C45-13-1	3/8" × 1/2"	393,75
C45-13-2	3/8" × 3/4"	563,75
C45-14	1/2" × 1/4"	401,25
C45-15	1/2" × 3/8"	401,25
C45-17	1/2"	486,25
C45-17-1	1/2" × 3/4"	550,50
C45-18	3/4" × 1/2"	595,75
C45-20	3/4"	635,50
C45-22	1" × 3/4"	891,00
C45-23	1"	1054,00

Union klemring

AISI 316



Varenr.	ø	DKK
C40-1	1/8"	240,75
C40-3	1/4"	253,00
C40-4	3/8"	315,00
C40-5	1/2"	633,75
C40-6	3/4"	858,25
C40-7	1"	949,50

Skotgennemføring klemring

AISI 316



Varenr.	Ø × ø	DKK
C123-1	1/4" × 1/8"	119,75
C123-2	3/8" × 1/8"	α
C123-3	3/8" × 1/4"	130,25
C123-4	1/2" × 1/4"	173,75
C123-5	1/2" × 3/8"	185,75
C123-6	3/4" × 1/2"	295,50
C123-7	1" × 1/2"	α

Vinkel 90° klemring/muffe

AISI 316 - NPT



Varenr.	ø × NPT	DKK
C28-1	1/8"	403,00
C28-2	1/8" × 1/4"	435,75
C28-3	1/4" × 1/8"	334,75
C28-4	1/4"	380,50
C28-5	1/4" × 3/8"	471,75
C28-6	1/4" × 1/2"	635,75
C28-7	3/8" × 1/8"	394,25
C28-8	3/8" × 1/4"	448,50
C28-9	3/8"	467,00
C28-10	3/8" × 1/2"	659,25
C28-11	1/2" × 1/4"	588,25
C28-12	1/2" × 3/8"	620,25
C28-13	1/2"	728,50
C28-14	3/4" × 1/2"	918,25
C28-15	3/4"	1298,00
C28-16	1" × 3/4"	1768,75
C28-17	1"	2340,25

Union klemring red.

AISI 316



Varenr.	ø	DKK
C41-1-2	1/4" × 1/8"	170,25
C41-1-6	3/8" × 1/8"	212,50
C41-1	3/8" × 1/4"	220,00
C41-2-1	1/2" × 1/8"	253,75
C41-2	1/2" × 1/4"	253,75
C41-3	1/2" × 3/8"	276,25
C41-4-1	3/4" × 1/4"	556,50
C41-4-2	3/4" × 3/8"	556,50
C41-4	3/4" × 1/2"	556,50
C41-5	1" × 1/2"	690,75
C41-6	1" × 3/4"	753,25

Vinkel 90° klemring

AISI 316



Varenr.	ø	DKK
C43-1	1/8"	316,50
C43-3	1/4"	280,75
C43-4	3/8"	3251,00
C43-5	1/2"	392,50
C43-6	3/4"	665,25
C43-7	1"	1087,75

Vinkel 90° klemring/muffe

AISI 316 - NPT



Varenr.	ø × NPT	DKK
C92-1	1/8"	262,75
C92-2	1/8" × 1/4"	306,00
C92-3	1/4" × 1/8"	228,75
C92-4	1/4"	260,00
C92-5	1/4" × 3/8"	380,50
C92-6	1/4" × 1/2"	430,25
C92-7	3/8" × 1/8"	255,25
C92-8	3/8" × 1/4"	267,50
C92-9	3/8"	301,25
C92-10	3/8" × 1/2"	443,25
C92-11	1/2" × 1/4"	343,75
C92-12	1/2" × 3/8"	363,25
C92-13	1/2"	490,75
C92-14	3/4" × 1/2"	622,25
C92-15	3/4"	980,00
C92-16	1" × 3/4"	1310,25
C92-17	1"	1572,00

T-stk klemring

AISI 316



Varenr.	ø	DKK
C48-1	1/8"	479,75
C48-3	1/4"	392,50
C48-4	3/8"	442,00
C48-5	1/2"	551,25
C48-6	3/4"	1074,50
C48-7	1"	1656,25

T-stk klemring/nippel gren

AISI 316 - NPT



Varenr.	ø × NPT × ø	DKK
C74-1	1/8"	332,00
C74-2	1/8" × 1/4" × 1/8"	561,25
C74-3	1/4" × 1/8" × 1/4"	315,00
C74-4	1/4"	380,50
C74-5	3/8" × 1/4" × 3/8"	402,25
C74-6	3/8"	445,75
C74-7	1/2" × 3/8" × 1/2"	612,25
C74-8	1/2"	653,25
C74-9	3/4"	964,75

T-stk klemring/muffe gren

AISI 316 - NPT



Varenr.	ø × NPT × ø	DKK
C83-1	1/8"	414,75
C83-14	1/8" × 1/4" × 1/8"	332,50
C83-2	1/4" × 1/8" × 1/4"	380,50
C83-3	1/4"	443,25
C83-15	1/4" × 3/8" × 1/4"	341,75
C83-16	1/4" × 1/2" × 1/4"	471,25
C83-17	3/8" × 1/8" × 3/8"	341,75
C83-4	3/8" × 1/4" × 3/8"	456,75
C83-18	3/8"	755,00
C83-19	3/8" × 1/2" × 3/8"	928,25
C83-5	1/2" × 1/4" × 1/2"	692,00
C83-6	1/2" × 3/8" × 1/2"	647,50
C83-7	1/2"	741,25
C83-20	3/4" × 1/2" × 3/4"	881,00
C83-8	3/4"	1271,25
C83-9	1" × 3/4" × 1"	2181,75
C83-10	1"	2269,25

T-stk klemring/nippel

AISI 316 - NPT



Varenr.	NPT × ø × ø	DKK
C73-1	1/8"	332,00
C73-2	1/4" × 1/8" × 1/8"	561,25
C73-3	1/8" × 1/4" × 1/4"	315,00
C73-4	1/4"	380,50
C73-5	1/4" × 3/8" × 3/8"	402,25
C73-6	3/8"	445,75
C73-7	3/8" × 1/2" × 1/2"	612,25
C73-8	1/2"	653,25
C73-9	3/4"	964,75

T-stk klemring/muffe ende

AISI 316 - NPT



Varenr.	NPT × ø × ø	DKK
C81-1	1/8"	414,75
C81-10	1/4" × 1/8" × 1/8"	332,50
C81-2	1/8" × 1/4" × 1/4"	391,50
C81-3	1/4"	443,25
C81-11	3/8" × 1/4" × 1/4"	341,75
C81-12	1/2" × 1/4" × 1/4"	471,25
C81-13	1/8" × 3/8" × 3/8"	341,75
C81-4	1/4" × 3/8" × 3/8"	456,75
C81-14	3/8"	341,75
C81-15	1/2" × 3/8" × 3/8"	471,25
C81-16	1/4" × 1/2" × 1/2"	471,25
C81-5	3/8" × 1/2" × 1/2"	647,50
C81-6	1/2"	741,25
C81-17	1/2" × 3/4" × 3/4"	881,00
C81-7	3/4"	1271,25
C81-18	3/4" × 1" × 1"	3123,00
C81-19	1"	3501,00

Kryds klemring

AISI 316



Varenr.	Ø	DKK
C56-1	1/8"	494,25
C56-3	1/4"	463,00
C56-4	3/8"	547,75
C56-5	1/2"	755,00
C56-6	3/4"	¤
C56-7	1"	¤

¤ = spørg på pris

Nippel klemring rør

AISI 316 - NPT



Varenr.	Ø × NPT	DKK
C93-1	1/8"	84,10
C93-2	1/4" × 1/8"	74,80
C93-3	1/4"	80,55
C93-4	3/8" × 1/4"	107,50
C93-5	3/8"	125,00
C93-6	3/8" × 1/2"	149,75
C93-7	1/2" × 1/4"	161,75
C93-8	1/2" × 3/8"	169,25
C93-9	1/2"	180,00
C93-10	3/4"	276,25
C93-11	1"	485,00

Nippel klemring rør m. muffe

AISI 316 - NPT

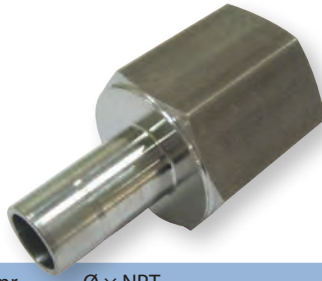

Varenr.	Ø × NPT	DKK
C94-1	1/8"	105,00
C94-2	1/8" × 1/4"	122,00
C94-3	1/4" × 1/8"	107,50
C94-4	1/4"	131,50
C94-5	1/4" × 3/8"	157,25
C94-6	1/4" × 1/2"	180,00
C94-7	3/8" × 1/8"	135,25
C94-8	3/8" × 1/4"	136,25
C94-9	3/8"	177,50
C94-10	3/8" × 1/2"	235,00
C94-11	1/2" × 1/4"	182,50
C94-12	1/2" × 3/8"	184,75
C94-13	1/2"	263,75
C94-14	3/4" × 1/2"	239,25
C94-15	3/4"	341,25
C94-16	3/4" × 1"	694,50
C94-17	1" × 3/4"	605,00
C94-18	1"	732,50
C94-19	1 1/4"	1998,25
C94-20	1 1/2"	2728,50
C94-21	2"	5399,50

Nippel klemring/rørende red.

AISI 316



Varenr.	Ø × Ø	DKK
C57-1	1/8"	159,25
C57-3	1/4" × 1/8"	135,25
C57-4	3/8" × 1/8"	137,75
C57-5	1/2" × 1/8"	154,50
C57-8	1/8" × 1/4"	166,50
C57-10	1/4"	124,25
C57-12	3/8" × 1/4"	124,25
C57-13	1/2" × 1/4"	133,25
C57-15	3/4" × 1/4"	133,25
C57-18	1/4" × 3/8"	158,25
C57-19	3/8"	159,25
C57-20	1/2" × 3/8"	159,25
C57-22	3/4" × 3/8"	192,25
C57-23	1/4" × 1/2"	144,25
C57-24	3/8" × 1/2"	200,50
C57-25	1/2"	200,50
C57-27	3/4" × 1/2"	208,75
C57-28	1" × 1/2"	294,00
C57-32	1/2" × 3/4"	412,50
C57-33	1" × 3/4"	412,50
C57-34	1 1/4" × 1"	2322,75
C57-35	1 1/2" × 1"	3206,50
C57-36	2" × 1"	5734,25
C57-37	1 1/2" × 1 1/4"	4049,00
C57-38	2" × 1 1/4"	6283,00
C57-39	2" × 1 1/2"	6748,75

Skotgennemføring klemring

AISI 316



Varenr.	Ø × Ø	Ext. dim	DKK
C95-1	1/8"	9	263,75
C95-2	3/8"	15	276,25

Slutmuffe klemring

AISI 316



Klemring bageste ring

AISI 316



Varenr.	∅	DKK
C61-1	1/8"	11,80
C61-3	1/4"	16,45
C61-4	3/8"	18,50
C61-5	1/2"	24,65
C61-6	3/4"	45,55
C61-7	1"	57,10

Varenr.	∅	DKK
C59-1	1/8"	144,50
C59-3	1/4"	147,50
C59-4	3/8"	164,25
C59-5	1/2"	191,25
C59-6	3/4"	294,50
C59-7	1"	335,75

Omløber klemring

AISI 316

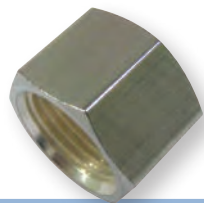

Klemring forreste ring

AISI 316



Varenr.	∅	DKK
C62-1	1/8"	9,35
C62-3	1/4"	13,10
C62-4	3/8"	16,45
C62-5	1/2"	22,55
C62-6	3/4"	32,40
C62-7	1"	63,05

Varenr.	∅	UNF gev.	DKK
C60-1	1/8"	7/16"	40,85
C60-3	1/4"	9/16"	36,60
C60-4	3/8"	11/16"	41,70
C60-5	1/2"	7/8"	51,15
C60-6	3/4"	1 1/8"	110,50
C60-7	1"	1 1/2"	136,25

Slutmuffe klemring

AISI 316



Varenr.	∅	DKK
C96-1	1/8"	89,60
C96-3	1/4"	77,25
C96-4	3/8"	105,00
C96-5	1/2"	153,50
C96-6	3/4"	249,75
C96-7	1"	463,00

PUSH-IN FITTINGS RUSTFRI AISI 316



B serie: -0,99 til +15 bar
CP serie: -0,99 til +140 bar



B serie: -15°C til +225°C
CP serie: -110°C til +300°C



Rustfri syrefast push-in fittings i flot, ergonomisk design. Kan bruges til mange slags rør: PA, PE, PU samt PTFE. Alle cylindriske gevind kommer med VITON O-ringe, der sikrer nem og hurtig montering og gør dem særdeles velegnet til farmaceutisk-, kemi-, fødevarer- og medicinalindustri. Fødevaregodkendt.



VITON® o-ring.



O-ringen mellem slange/rør og fittings sikrer total tætning også under udsatte installationer.



Alle lige fittings med gevind kan samles med en unbrakonøgle.

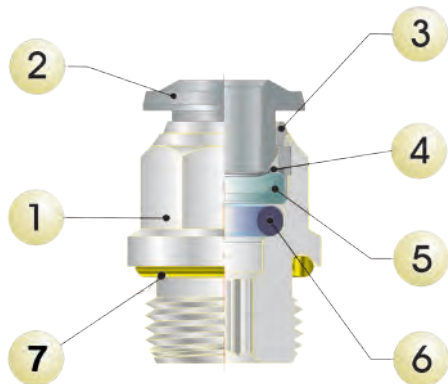

1. AISI 316L krop
2. AISI 316L krave
3. AISI 316L kraveholder
4. AISI 316L gribe ring
5. Teflon sikkerhedsring
6. VITON® o-ring
7. VITON® tætnings o-ring



Vores fødevarerprodukter opfylder kravene til direkte kontakt med fødevarer.

Fittings der hører til eliten!

Push-in har en ring med bagudrettede tænder, der griber ind i slangen og hindrer, at man kan trække slangen ud. Udløserringen presser tænderne væk fra slangen, der så kan tages ud af fittingen.

Selve tætningen er en O-ring, placeret lige under de tænder, der fastholder slangen i fittingen. O-ringstype se teknisk beskrivelse.

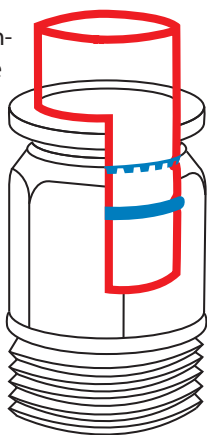

Nippel push-in AISI 316 - BSPT



Varenr.	ø × BSPT	DKK
B80-1	4 × 1/8"	173,25
B80-1-1	4 × 1/4"	193,00
B80-2	6 × 1/8"	206,50
B80-3	6 × 1/4"	216,75
B80-4	8 × 1/8"	227,75
B80-5	8 × 1/4"	233,25
B80-6	10 × 1/4"	302,25
B80-7	10 × 3/8"	239,25
B80-8	12 × 3/8"	477,50
B80-9	12 × 1/2"	531,00

Nippel push-in AISI 316 / VITON - BSPP



Varenr.	ø × BSPP	DKK
B81-1	4 × M5	239,00
B81-2	4 × 1/8"	235,50
B81-2-1	4 × 1/4"	237,75
B81-3	6 × 1/8"	235,50
B81-4	6 × 1/4"	263,75
B81-5	8 × 1/8"	261,50
B81-6	8 × 1/4"	296,75
B81-7	10 × 1/4"	324,00
B81-8	10 × 3/8"	392,00
B81-9	12 × 3/8"	493,25
B81-10	12 × 1/2"	546,75

Vinkel 90° push-in AISI 316



Varenr.	ø	DKK
B82-1	4	335,50
B82-2	6	357,25
B82-3	8	413,25
B82-4	10	568,25
B82-5	12	790,00

Vinkel 90° push-in/nippel svivel AISI 316 - BSPT



Varenr.	ø × BSPT	DKK
B84-0	4 × 1/8"	440,75
B84-2	4 × 1/4"	481,75
B84-3	6 × 1/8"	444,00
B84-4	6 × 1/4"	510,50
B84-5	8 × 1/8"	520,75
B84-6	8 × 1/4"	529,75
B84-7	10 × 1/4"	699,25
B84-8	10 × 3/8"	715,00
B84-8-1	10 × 1/2"	740,25
B84-9	12 × 3/8"	914,25
B84-10	12 × 1/2"	940,50

Vinkel 90° push-in/nippel svivel AISI 316 / VITON - BSPP



Varenr.	ø × BSPP	DKK
B86-1	4 × M5	433,25
B86-2	4 × 1/8"	447,75
B86-2-1	4 × 1/4"	482,75
B86-3	6 × 1/8"	482,75
B86-4	6 × 1/4"	513,50
B86-5	8 × 1/8"	528,50
B86-6	8 × 1/4"	531,00
B86-8	10 × 1/4"	703,00
B86-9	10 × 3/8"	774,25
B86-10	10 × 1/2"	967,75
B86-11	12 × 3/8"	932,75
B86-12	12 × 1/2"	1186,75

T-stk push-in

AISI 316



Varenr.	∅	DKK
B94-1	4	471,25
B94-2	6	494,75
B94-3	8	572,00
B94-4	10	769,75
B94-5	12	956,25

T-stk push-in/nippel svivel

AISI 316 - BSPT



Varenr.	∅ × BSPT × ∅	DKK
B89K-1	4 × 1/8" × 4	463,00
B89K-2	4 × 1/4" × 4	586,25
B89K-3	6 × 1/8" × 6	588,75
B89K-4	6 × 1/4" × 6	626,00
B89K-5	8 × 1/8" × 8	651,75
B89K-6	8 × 1/4" × 8	660,75
B89K-7	10 × 1/4" × 10	902,25
B89K-8	10 × 3/8" × 10	916,25
B89K-9	10 × 1/2" × 10	942,50
B89K-10	12 × 3/8" × 12	1180,50
B89K-11	12 × 1/2" × 12	1205,25

T-stk push-in/nippel svivel

AISI 316 / VITON - BSPP



Varenr.	∅ × BSPP × ∅	DKK
B89C-1	4 × M5 × 4	528,50
B89C-2	4 × 1/8" × 4	513,50
B89C-3	4 × 1/4" × 4	588,75
B89C-4	6 × 1/8" × 6	621,75
B89C-5	6 × 1/4" × 6	626,00
B89C-6	8 × 1/8" × 8	658,50
B89C-7	8 × 1/4" × 8	662,25
B89C-8	10 × 1/4" × 10	906,75
B89C-9	10 × 3/8" × 10	977,50
B89C-10	10 × 1/2" × 10	1171,25
B89C-11	12 × 3/8" × 12	1197,00
B89C-12	12 × 1/2" × 12	1453,50

Union push-in

AISI 316



Varenr.	∅	DKK
B97-1	4	258,75
B97-2	6	262,75
B97-3	8	300,75
B97-4	10	407,25
B97-5	12	603,00

Skotgennemføring push-in

AISI 316



Varenr.	∅	Ext. dim	DKK
B98-1	4	M12*1	428,00
B98-2	6	M14*1	462,00
B98-3	8	M16*1	552,00
B98-4	10	M20*1	703,00
B98-5	12	M22*1	865,75

Brystnippel

AISI 316 - BSPT



Max 140 bar		
Varenr.	BSPT	DKK
CP200-1	1/8"	109,50
CP200-2	1/4"	133,00
CP200-3	3/8"	145,50
CP200-4	1/2"	174,00
CP200-5	3/4"	199,50

Brystnippel reduktion

AISI 316 - BSPT



Max 140 bar		
Varenr.	BSPT	DKK
CP201-1-2	1/4" × 1/8"	150,25
CP201-1-3	3/8" × 1/8"	163,75
CP201-2-3	3/8" × 1/4"	163,75
CP201-2-4	1/2" × 1/4"	187,50
CP201-3-4	1/2" × 3/8"	188,50
CP201-4-5	3/4" × 1/2"	253,25

Spidsmuffe

AISI 316 - BSPP×BSPT



Max 140 bar		
Varenr.	BSPP × BSPT	DKK
CP202-1-2	1/4" × 1/8"	140,00
CP202-2-3	3/8" × 1/4"	171,50
CP202-2-4	1/2" × 1/4"	211,00
CP202-3-4	1/2" × 3/8"	215,25
CP202-4-5	3/4" × 1/2"	275,00

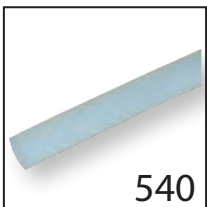

Nippelmuffe

AISI 316 - BSPT×BSPP



Max 140 bar

Varenr.	BSPT × BSPP	DKK
CP203-2-1	1/4" × 1/8"	127,00
CP203-3-1	3/8" × 1/8"	138,75
CP203-3-2	3/8" × 1/4"	142,00
CP203-4-2	1/2" × 1/4"	169,25
CP203-4-3	1/2" × 3/8"	178,75
CP203-5-4	3/4" × 1/2"	215,25

Muffe

AISI 316 - BSPP



Max 140 bar

Varenr.	BSPP	DKK
CP204-1	1/8"	61,70
CP204-2	1/4"	87,35
CP204-3	3/8"	124,00
CP204-4	1/2"	200,50
CP204-5	3/4"	300,00

Formmuffe

AISI 316 - BSPP



Max 140 bar

Varenr.	BSPP	DKK
CP205-1-2	1/4" × 1/8"	82,75
CP205-2-3	3/8" × 1/4"	122,25
CP205-3-4	1/2" × 3/8"	152,50
CP205-4-5	3/4" × 1/2"	255,25

Rørprop Unbrako

AISI 316 / VITON - BSPP



-15° til +225°C, 15bar

Varenr.	BSPP	DKK
CP206-1	1/8"	157,25
CP206-2	1/4"	175,50
CP206-3	3/8"	194,75
CP206-4	1/2"	195,75

Rørprop sekskant

AISI 316 - BSPT

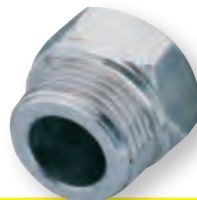

Max 140 bar

Varenr.	BSPT	DKK
CP207-1	1/8"	118,00
CP207-2	1/4"	129,25
CP207-3	3/8"	142,00
CP207-4	1/2"	176,50
CP207-5	3/4"	220,00

Rørprop Unbrako

AISI 316 - BSPT



Max 140 bar

Varenr.	BSPT	DKK
CP208-1	1/8"	100,25
CP208-2	1/4"	108,50
CP208-3	3/8"	121,50
CP208-4	1/2"	153,50

Slangenippel

AISI 316 - BSPT



Max 140 bar

Varenr.	Ø × BSPT	DKK
CP209-1	6 × 1/8"	72,90
CP209-2	7 × 1/8"	72,90
CP209-3	7 × 1/4"	88,75
CP209-4	8 × 1/4"	88,75
CP209-5	9 × 1/4"	88,75
CP209-6	9 × 3/8"	115,00
CP209-7	10 × 1/4"	88,75
CP209-8	10 × 3/8"	115,00
CP209-9	10 × 1/2"	172,75
CP209-10	12 × 1/4"	88,75
CP209-11	12 × 3/8"	115,00
CP209-12	12 × 1/2"	172,75
CP209-13	14 × 3/8"	113,50
CP209-14	14 × 1/2"	172,75
CP209-15	16 × 1/2"	172,75
CP209-16	18 × 1/2"	172,75
CP209-17	18 × 3/4"	246,50
CP209-18	20 × 1/2"	172,75
CP209-19	20 × 3/4"	246,50

Slangenippel

AISI 316 / VITON - BSPP



Varenr.	Ø × BSPP	DKK
B105-10	10 × 1/4"	125,75
B105-11	10 × 3/8"	171,00
B105-12	12 × 3/8"	182,00
B105-13	12 × 1/2"	270,00

Vinkel 90° muffe

AISI 316 - BSPP



Max 140 bar

Varenr.	BSPP	DKK
CP213-1	1/8"	243,00
CP213-2	1/4"	332,00
CP213-3	3/8"	415,75
CP213-4	1/2"	510,00

T-stk muffe/nippel/muffe

AISI 316 - BSPP×BSPT



Max 140 bar

Varenr.	BSPP × BSPT × BSPP	DKK
CP211-1	1/8"	301,25
CP211-2	1/4"	422,75
CP211-3	3/8"	546,50
CP211-4	1/2"	674,00

Vinkel 90° muffe/nippel

AISI 316 - BSPP×BSPT



Max 140 bar

Varenr.	BSPP × BSPT	DKK
CP214-1	1/8"	243,00
CP214-2	1/4"	332,00
CP214-3	3/8"	415,75
CP214-4	1/2"	510,00

T-stk muffe/muffe/nippel

AISI 316 - BSPT×BSPP



Max 140 bar

Varenr.	BSPT × BSPP × BSPP	DKK
CP212-1	1/8"	301,25
CP212-2	1/4"	422,75
CP212-3	3/8"	546,50
CP212-4	1/2"	674,00

T-stk muffe

AISI 316 - BSPP



Max 140 bar

Varenr.	BSPP	DKK
CP210-1	1/8"	301,25
CP210-2	1/4"	422,75
CP210-3	3/8"	546,50
CP210-4	1/2"	674,00

PUSH-ON FITTINGS RUSTFRI AISI 316



-0,99bar til max 20bar



-15°C til +200°C



Push-on fittings er særdeles velegnet til luft og væsker til max 20 bar.

Fødevaregodkendt.



Vores fødevareprodukter opfylder kravene til direkte kontakt med fødevarer.

Fittings der hører til eliten!

Nippel push-on

AISI 316 / VITON - BSPP



Varenr.	Ø/ø × BSPP	L	DKK
BE51-1	6/4 × 1/8"	23	164,00
BE51-2	6/4 × 1/4"	25,5	186,50
BE51-3	8/6 × 1/8"	23	167,00
BE51-4	8/6 × 1/4"	25,5	190,25
BE51-6	10/8 × 1/4"	27,5	203,00
BE51-7	10/8 × 3/8"	29	216,00

Union push-on

AISI 316

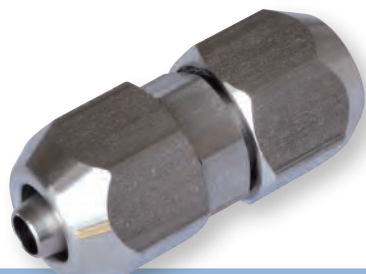

Varenr.	Ø/ø	L	DKK
BE54-3	6/4	29,5	274,25
BE54-4	8/6	30	282,75
BE54-5	10/8	34,5	319,50

Skotgennemføring push-on

AISI 316



Varenr.	Ø/ø	Ext. dim	L	DKK
BE55-3	6/4	M10*1	44	393,75
BE55-4	8/6	M12*1	44	431,50

Vinkel 90° push-on/nippel

AISI 316 - BSPT



Varenr.	Ø/ø × BSPT	L1 × L2	DKK
BE56-1	6/4 × 1/8"	21 × 15,5	322,75
BE56-2	6/4 × 1/4"	21 × 19,5	327,00
BE56-3	8/6 × 1/8"	22,5 × 17	333,50
BE56-4	8/6 × 1/4"	22,5 × 21	338,00
BE56-7	10/8 × 1/4"	25,5 × 21,5	381,00
BE56-8	10/8 × 3/8"	25,5 × 22	385,00

Vinkel 90° push-on

AISI 316

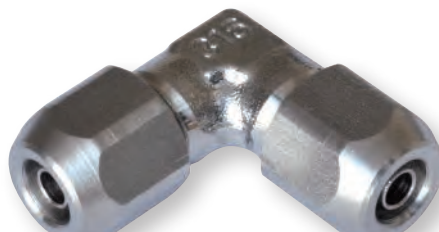

Varenr.	Ø/ø	L	DKK
BE58-1	6/4	21	403,00
BE58-2	8/6	22,5	415,75
BE58-3	10/8	25,5	476,25

T-stk push-on/nippel gren

AISI 316 - BSPT



Varenr.	Ø/ø × BSPT	L1 × L2	DKK
BE60-1	6/4 × 1/8"	42 × 15,5	527,75
BE60-2	6/4 × 1/4"	42 × 19,5	534,75
BE60-3	8/6 × 1/8"	45 × 17	552,00
BE60-4	8/6 × 1/4"	45 × 21	556,25
BE60-6	10/8 × 1/4"	51 × 21,5	598,00
BE60-7	10/8 × 3/8"	51 × 22	602,50

T-stk push-on

AISI 316



Varenr.	Ø/ø	L1 × L2	DKK
BE59-1	6/4	42 × 21	604,50
BE59-2	8/6	45 × 22,5	633,00
BE59-3	10/8	51 × 25,5	691,00

Omløber push-on

AISI 316



Varenr.	Ø/ø	Ext. dim	L	DKK
BE71-1	6/4	M10*1	11	76,70
BE71-2	8/6	M12*1	11,5	81,40
BE71-3	10/8	M14*1	13,5	93,40

INTERNETTET

Få login til vores hjemmeside og følg bedre med i nyheder. Vores hjemmeside opdateres løbende med nye produkter og nye tiltag i firmaet.

Produkterne er altid på hjemmesiden, før det nye katalog går i trykken. På den måde får vi afprøvet, om der er interesse for produkterne.

Du kan også læse om nye medarbejdere og om vores forhåbentlig fortsatte vækst, til gavn for dig som kunde. Flere produkter fra samme leverandør betyder besparede administrative omkostninger. Vores forpligtelse som professionel leverandør til vore kunder gør, at vi altid tænker på den bedst mulige service og kundebetjening; Gode priser og produkter til tiden.



WWW.ROYKON.DK

Google-søgning

Jeg prøver lykken



RØR, RØRHOLDERE, BOLTE & SKRUER

 **462** RØR

 **465** RØRHOLDERE

 **481** BOLTE & SKRUER

 **491** STRIPS

RØR



Rør af forskellige materialer og i forskellige dimensioner. Se under hvert enkelt for nærmere information.

Svejest kalibreret rør 2m

AISI 316

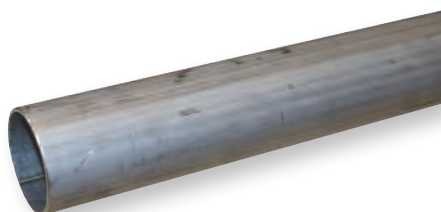

Varenr.	Ø	- -	DKK
BK35-0	4	1	218,50
BK35-1	6	1	227,25
BK35-2	8	1	279,50
BK35-3	10	1	349,50
BK35-4	12	1	419,25

Sælges kun i hele længder

Svejest kalibreret rør 6m

AISI 316

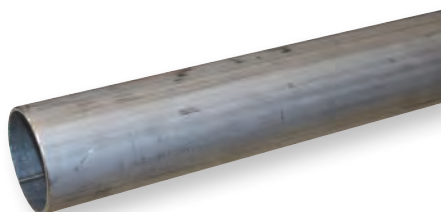

Varenr.	Ø	- -	DKK
B36-0	4	1	770,50
B36-1	6	1	321,25
B36-2	8	1	413,00
B36-3	10	1	499,25
B36-4	12	1	573,25
B36-5	15	1	692,25
B36-11-1	16	1	769,75
B36-6-2	18	1.5	923,00
B36-7-1	20	2	1264,00
B36-7	22	2	1589,50
B36-9-1	28	2	1906,75

Sælges kun i hele længder

Gevindrør 6m

AISI 316

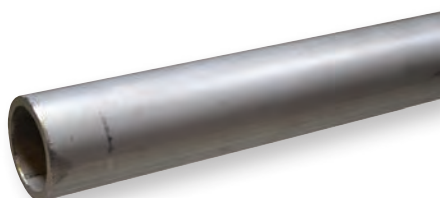

Varenr.	dim	- -	DKK
B36-92	1/4" ~ 13,72	2.24	729,25
B36-93	3/8" ~ 17,2	2.30	900,75
B36-94	1/2" ~ 21,3	2.65	1469,00
B36-95	3/4" ~ 26,9	2.65	1649,25
B36-96	1" ~ 33,7	3.25	2558,75
B36-97	1 1/4" ~ 42,4	3.25	3259,00
B36-98	1 1/2" ~ 48,3	3.25	3619,50
B36-99	2" ~ 60,3	3.65	6053,50
B36-99-1	2 1/2" ~ 76,1	3.60	5232,00
B36-99-2	3" ~ 88,9	4.05	8297,75

Sælges kun i hele længder

Gevindrør 2m

AISI 316



Varenr.	dim	- -	DKK
BK36-1	1/8"	2	183,50
BK36-2	1/4"	2	216,50
BK36-3	3/8"	2	273,00
BK36-4	1/2"	2.5	382,25
BK36-5	3/4"	2.5	482,75
BK36-6	1"	3.0	720,50
BK36-7	1 1/4"	3.0	922,75
BK36-8	1 1/2"	3.0	1063,00
BK36-9	2"	3.5	1534,75
BK36-10	2 1/2"	3.5	1949,00
BK36-11	3"	4.0	2609,00
BK36-12	4"	4.5	3794,75

Sælges kun i hele længder



424



391



562

Press rør 6m

AISI 316

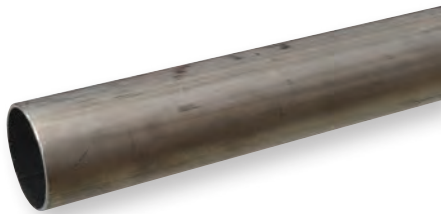

Varenr.	Ø	- -	DKK
PC1-15	15	1	666,75
PC1-18	18	1	760,00
PC1-22	22	1.2	1015,50
PC1-28	28	1.2	1229,00
PC1-35	35	1.5	1871,75
PC1-42	42	1.5	2259,00
PC1-54	54	1.5	2917,00
PC1-76	76.1	2	5693,00
PC1-88	88.9	2	6328,50
PC1-108	108	2	8126,75

Sælges kun i hele længder

Gevindrør

MESSING - BSPP



L: 96 cm ~ 106 CM		
Varenr.	BSPP	DKK
E36-3	3/8"	664,50
E36-4	1/2"	765,25
E36-5	3/4"	1068,25
E36-6	1"	1355,50
E36-7	1 1/4"	1720,25
E36-8	1 1/2"	2004,50
E36-9	2"	3906,00

Trykrør PN6

U-PVC (POLYVINYLCHLORID)

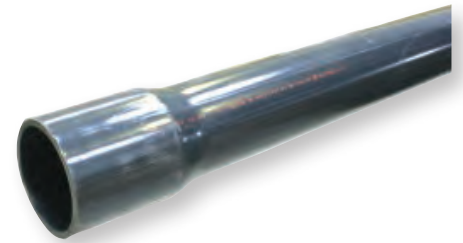

Med 1 klæbemuffe				
Varenr.	dim	- -	L	DKK
AP6-75	Ø75	2,2	6m	300,25
AP6-90	Ø90	2,7	6m	396,50
AP6-110	Ø110	3,3	5m	488,50
AP6-125	Ø125	3,7	5m	522,75
AP6-140	Ø140	4,1	6m	1716,00
AP6-160	Ø160	4,7	5m	999,25
AP6-200	Ø200	5,9	5m	1521,50
AP6-225	Ø225	6,6	6m	3598,00
AP6-315	Ø315	9,2	5m	4838,00

Sælges kun i hele længder

Galvaniseret rør glat 2m

GALVANISERET

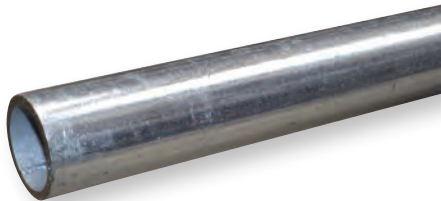

Varenr.	Str.	DKK
GK36-4	1/2"	84,10
GK36-5	3/4"	99,35
GK36-6	1"	141,50
GK36-7	1 1/4"	172,25
GK36-8	1 1/2"	195,00
GK36-9	2"	271,50

Rør i rulle

KOBBER



Varenr.	Ø	- -	L	DKK/m
CU1-1	4	1	65m	31,60
CU1-4	6	1	50m	45,70
CU1-6	8	1	50m	52,05
CU1-8	10	1	50m	70,45
CU1-9	12	1	50m	78,65
	Ø			
CU2-0	1/8"		50m	97,80
CU2-1	3/16"		50m	45,35
CU2-2	1/4"		50m	52,30
CU2-4	3/8"		50m	59,00
CU2-6	1/2"		50m	79,75

Sælges kun i fuld længde

Trykrør PN10

U-PVC (POLYVINYLCHLORID)



Med 1 klæbemuffe				
Varenr.	dim	- -	L	DKK
AP1-25-1	Ø25	1,5	5m	51,65
AP1-32-1	Ø32	1,8	5m	73,70
AP1-40-1	Ø40	1,9	5m	108,00
AP1-50-1	Ø50	2,4	5m	179,00
AP1-63-1	Ø63	3,0	5m	277,25
AP1-75-1	Ø75	2,9	5m	394,50
AP1-90-1	Ø90	3,5	5m	565,00
AP1-110-1	Ø110	4,2	5m	685,25
AP1-125-1	Ø125	4,8	5m	910,50
AP1-140	Ø140	5,4	6m	1152,00
AP1-160-1	Ø160	6,2	5m	1462,75
AP1-200-1	Ø200	7,7	6m	3134,50
AP1-225-1	Ø225	8,6	6m	3424,75
AP1-250-1	Ø250	9,6	6m	4243,75
AP1-280-1	Ø280	13,4	6m	5285,00
AP1-315-1	Ø315	12,1	6m	6706,50

Sælges kun i hele længder

Trykrør klar PN10 5m

U-PVC (POLYVINYLCHLORID)

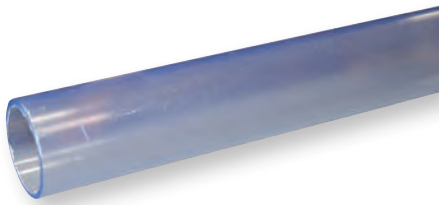

Uden klæbemuffe

Varenr.	dim	- -	Bar	DKK
APT1-25	Ø25	1,9	16	805,25
APT1-32	Ø32	1,8	10	1144,50
APT1-40	Ø40	2,0	10	1610,00
APT1-50	Ø50	2,4	10	1699,50
APT1-63	Ø63	3,0	10	2564,75

Sælges kun i hele længder

Rør 4m

PP (POLYPROPYLEN)

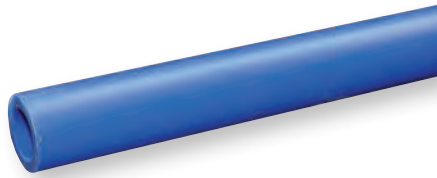

Til aggressive miljøer

Varenr.	Ø/ø	DKK
AJ1-2	20/13,2	65,55
AJ1-3	25/16,6	99,95
AJ1-4	32/21,2	158,50

Sælges kun i hele længder

PEM rør 100m PN10 SDR 11

PE (POLYETHYLEN)



100m trykrør i rulle til drikkevandsforsyning. Max 60°C (over 40°C forkortes levetiden).

Varenr.	ø	- -	DKK
070612020	20	2,0	3255,00
070612025	25	2,3	3790,50
070612032	32	2,9	5933,00
070612040	40	3,7	9023,00
070612050	50	4,6	14832,00
070612063	63	5,8	23896,00

Sælges kun i fuld længde.

Leveringstid 1-2 dage.

Trykrør PN16 5m

U-PVC (POLYVINYLCHLORID)

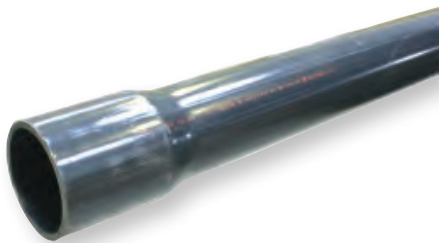

Med 1 klæbemuffe

Varenr.	dim	- -	L	DKK
AP1-12-1	Ø12	1,0	5m	28,40
AP1-16-1	Ø16	1,2	5m	51,25
AP1-20-1	Ø20	1,5	5m	51,65
AP1-25	Ø25	1,9	5m	97,85
AP1-32	Ø32	2,4	5m	141,75

Sælges kun i hele længder

Trykrør PN16 6m

U-PVC (POLYVINYLCHLORID)

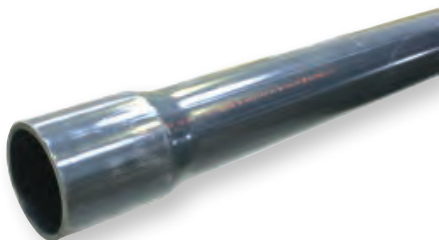

Med 1 klæbemuffe

Varenr.	dim	- -	L	DKK
AP4-125	Ø125	7,4	6m	1587,25 ₺
AP4-140	Ø140	8,3	6m	2009,75 ₺

₺ = så længe lager haves. Kun i hele længder

Rør 3m

PA (POLYAMID)



Varenr.	Ø/ø	BAR 20°C	DKK/m
AJ5-28	28/23	20	178,50 ₺

₺ = så længe lager haves

Udnyttelsesgrad for de tilladte driftstryk:

Temperaturområde:							
20°C	30°C	40°C	50°C	60°C	70°C	80°C - 100°C	
AJ5 rør:							
100%	80%	60%	50%	45%	40%	30%	

Afgrater

STÅL



Varenr.	Ø	DKK
M1-25	6-42	132,00

RØRHOLDERE



Meget bredt program af rørholdere. Se specifikationer under hver type.

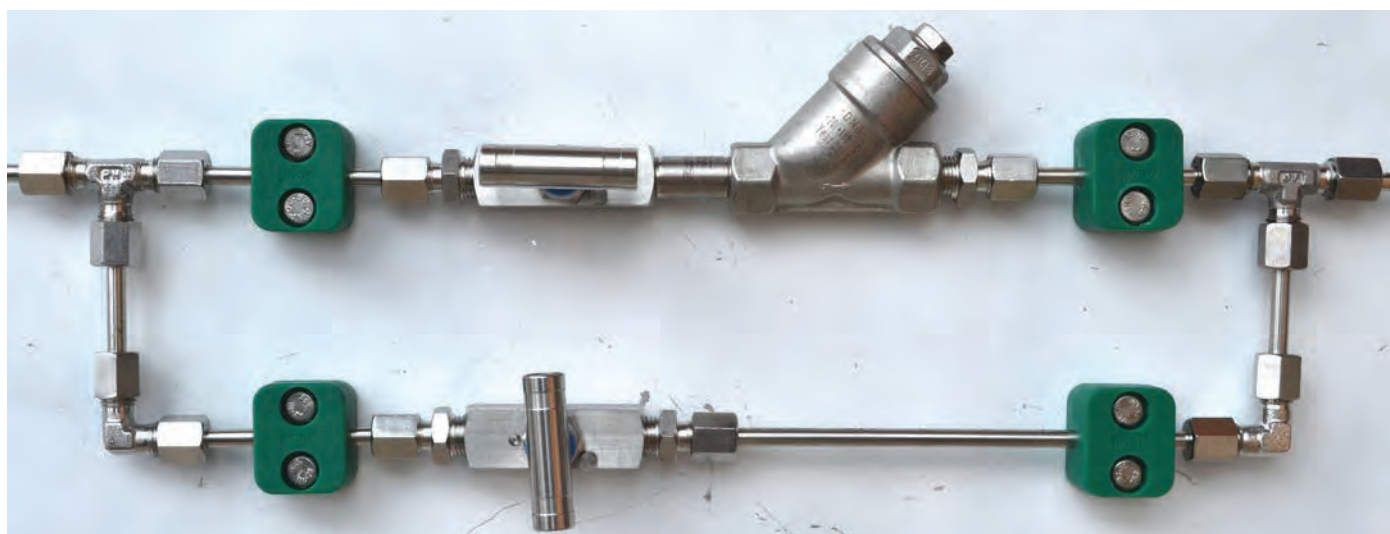

Rørholder halvskål PP (POLYPROPYLEN)



Varenr.	∅	DKK
BR68-1A	6	3,80
BR68-2A	8	3,80
BR68-3A	10	3,80
BR68-4A	12	3,80
BR68-5A	13,5 ~ 1/4"	4,20
BR68-6A	14 ~ 1/4"	4,20
BR68-7A	15	4,20
BR68-8A	16	4,20
BR68-9A	17,2 ~ 3/8"	4,20
BR68-10A	18	4,20
BR68-11A	20	5,55
BR68-12A	21,3 ~ 1/2"	5,55
BR68-13A	22	5,55
BR68-14A	25	5,55
BR68-15A	26,9 ~ 3/4"	6,95
BR68-16A	28	6,95
BR68-17A	30	6,95
BR68-18A	32	6,95
BR68-19A	33,7 ~ 1"	10,00
BR68-20A	35	10,00
BR68-21A	38	10,00
BR68-22A	42,4 ~ 1 1/4"	10,00
BR68-23A	48,3 ~ 1 1/2"	16,20

Rørholder halvskål PP (POLYPROPYLEN)



Varenr.	∅	DKK
BR68-1A-HVID	6	3,80
BR68-2A-HVID	8	3,80
BR68-3A-HVID	10	3,80
BR68-4A-HVID	12	3,80
BR68-5A-HVID	13,5 ~ 1/4"	4,20
BR68-7A-HVID	15	4,20
BR68-8A-HVID	16	4,20
BR68-9A-HVID	17,2 ~ 3/8"	4,20
BR68-10A-HVID	18	4,20
BR68-11A-HVID	20	5,55
BR68-12A-HVID	21,3 ~ 1/2"	5,55

Svejseplade AISI 316 - MM



Varenr.	dim	DKK
BR68-1-4B	6 - 12	104,50
BR68-5-10B	13,5 - 18	107,50
BR68-11-14B	20 - 25	111,00
BR68-15-18B	26,9 - 32	113,50
BR68-19-22B	33,7 - 42,4	118,00
BR68-23B	48,3	123,00

Bolt Unbrako M6 AISI 316 (A4) - MM



Bruges uden forplade

Varenr.	dim	L	DKK
BR68-1-4C	6 - 12	20mm	5,55
BR68-5-10C	13,5 - 18	25mm	6,10
BR68-11-14C	20 - 25	30mm	6,95
BR68-15-18C	26,9 - 32	35mm	8,10
BR68-19-22C	33,7 - 42,4	50mm	11,25
BR68-23C	48,3	60mm	15,20

Forplade AISI 316



Varenr.	dim	DKK
BR68-1-4D	6 - 12	21,55
BR68-5-10D	13,5 - 18	24,40
BR68-11-14D	20 - 25	26,90
BR68-15-18D	26,9 - 32	30,40
BR68-19-22D	33,7 - 42,4	35,55
BR68-23D	48,3	40,05



Rørholder halvskål PP (POLYPROPYLEN)



Varenr.	∅	DKK
BR68-1A	6	3,80
BR68-2A	8	3,80
BR68-3A	10	3,80
BR68-4A	12	3,80
BR68-5A	13,5 ~ 1/4"	4,20
BR68-6A	14 ~ 1/4"	4,20
BR68-7A	15	4,20
BR68-8A	16	4,20
BR68-9A	17,2 ~ 3/8"	4,20
BR68-10A	18	4,20
BR68-11A	20	5,55
BR68-12A	21,3 ~ 1/2"	5,55
BR68-13A	22	5,55
BR68-14A	25	5,55
BR68-15A	26,9 ~ 3/4"	6,95
BR68-16A	28	6,95
BR68-17A	30	6,95
BR68-18A	32	6,95
BR68-19A	33,7 ~ 1"	10,00
BR68-20A	35	10,00
BR68-21A	38	10,00
BR68-22A	42,4 ~ 1 1/4"	10,00
BR68-23A	48,3 ~ 1 1/2"	16,20

Rørholder halvskål PP (POLYPROPYLEN)



Varenr.	∅	DKK
BR68-1A-HVID	6	3,80
BR68-2A-HVID	8	3,80
BR68-3A-HVID	10	3,80
BR68-4A-HVID	12	3,80
BR68-5A-HVID	13,5 ~ 1/4"	4,20
BR68-7A-HVID	15	4,20
BR68-8A-HVID	16	4,20
BR68-9A-HVID	17,2 ~ 3/8"	4,20
BR68-10A-HVID	18	4,20
BR68-11A-HVID	20	5,55
BR68-12A-HVID	21,3 ~ 1/2"	5,55

Svejseplade STÅL - MM



Varenr.	dim	DKK
BR68-1-4G	6 - 12	10,70
BR68-5-10G	13,5 - 18	10,70
BR68-11-14G	20 - 25	10,90
BR68-15-18G	26,9 - 32	11,55
BR68-19-22G	33,7 - 42,4	12,35
BR68-23G	48,3	14,20

Bolt Unbrako M6 STÅL - MM



Bruges uden forplade

Varenr.	dim	L	DKK
BR68-1-4H	6 - 12	20mm	2,27
BR68-5-10H	13,5 - 18	25mm	2,27
BR68-11-14H	20 - 25	30mm	2,27
BR68-15-18H	26,9 - 32	35mm	2,55
BR68-19-22H	33,7 - 42,4	50mm	3,57
BR68-23H	48,3	60mm	5,55

Forplade STÅL



Varenr.	dim	DKK
BR68-1-4i	6 - 12	3,80
BR68-5-10i	13,5 - 18	4,20
BR68-11-14i	20 - 25	4,54
BR68-15-18i	26,9 - 32	4,54
BR68-19-22i	33,7 - 42,4	4,77
BR68-23i	48,3	4,77

Sekskantbolt M6 STÅL - MM



Bruges med forplade

Varenr.	dim	L	DKK
BR68-1-4J	6 - 12	30mm	2,55
BR68-5-10J	13,5 - 18	35mm	2,55
BR68-11-14J	20 - 25	40mm	2,97
BR68-15-18J	26,9 - 32	45mm	3,35
BR68-19-22J	33,7 - 42,4	60mm	5,25
BR68-23J	48,3	70mm	6,45

Rørholder sæt
PP (POLYPROPYLEN) / AISI 316



Med svejseplade

Varenr.	ø	DKK
BR68-1	6	123,25
BR68-2	8	123,25
BR68-3	10	123,25
BR68-4	12	123,25
BR68-5	13,5	128,00
BR68-6	14	128,00
BR68-7	15	128,00
BR68-8	16	134,50
BR68-9	17,2	134,50
BR68-10	18	134,50
BR68-11	20	134,50
BR68-12	21,3	134,50
BR68-13	22	135,50
BR68-14	25	135,50
BR68-15	26,9	142,75
BR68-16	28	142,75
BR68-17	30	142,75
BR68-18	32	142,75
BR68-19	33,7	160,75
BR68-20	35	160,75
BR68-21	38	160,75
BR68-22	42,4	160,75
BR68-23	48,3	185,00

Rørholder sæt
PP (POLYPROPYLEN) / AISI 316



Med svejse- og forplade

Varenr.	ø	DKK
BR67-1	6	144,00
BR67-2	8	144,00
BR67-3	10	144,00
BR67-4	12	144,00
BR67-5	13,5	151,50
BR67-6	14	151,50
BR67-7	15	151,50
BR67-8	16	158,50
BR67-9	17,2	158,50
BR67-10	18	158,50
BR67-11	20	160,75
BR67-12	21,3	160,75
BR67-13	22	160,75
BR67-14	25	160,75
BR67-15	26,9	173,00
BR67-16	28	173,00
BR67-17	30	173,00
BR67-18	32	173,00
BR67-19	33,7	196,25
BR67-20	35	196,25
BR67-21	38	196,25
BR67-22	42,4	196,25
BR67-23	48,3	224,50

Rørholder sæt
PP (POLYPROPYLEN) / STÅL



Med svejseplade

Varenr.	ø	DKK
BR68-1-1	6	22,80
BR68-2-1	8	22,80
BR68-3-1	10	22,80
BR68-4-1	12	22,80
BR68-5-1	13,5	23,45
BR68-6-1	14	23,45
BR68-7-1	15	23,45
BR68-8-1	16	23,45
BR68-9-1	17,2	23,45
BR68-10-1	18	23,45
BR68-11-1	20	26,30
BR68-12-1	21,3	26,30
BR68-13-1	22	26,30
BR68-14-1	25	26,30
BR68-15-1	26,9	30,40
BR68-16-1	28	30,40
BR68-17-1	30	30,40
BR68-18-1	32	30,40
BR68-19-1	33,7	39,20
BR68-20-1	35	39,20
BR68-21-1	38	39,20
BR68-22-1	42,4	39,20
BR68-23-1	48,3	57,10

Rørholder sæt
PP (POLYPROPYLEN) / STÅL



Med svejse- og forplade

Varenr.	ø	DKK
BR67-1-1	6	26,60
BR67-2-1	8	26,60
BR67-3-1	10	26,60
BR67-4-1	12	26,60
BR67-5-1	13,5	27,85
BR67-6-1	14	27,85
BR67-7-1	15	27,85
BR67-8-1	16	27,85
BR67-9-1	17,2	27,85
BR67-10-1	18	27,85
BR67-11-1	20	30,70
BR67-12-1	21,3	30,70
BR67-13-1	22	30,70
BR67-14-1	25	30,70
BR67-15-1	26,9	34,95
BR67-16-1	28	34,95
BR67-17-1	30	34,95
BR67-18-1	32	34,95
BR67-19-1	33,7	44,00
BR67-20-1	35	44,00
BR67-21-1	38	44,00
BR67-22-1	42,4	44,00
BR67-23-1	48,3	62,00

Dobbelt rørholder sæt
PP (POLYPROPYLEN) / AISI 316

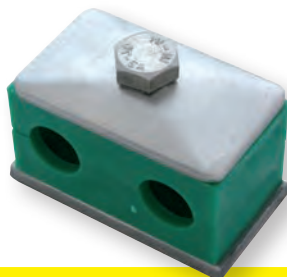

Med svejse- og forplade

Varenr.	ø	DKK
BR71-1	6	87,95
BR71-2	6,4	87,95
BR71-3	8	87,95
BR71-4	9,5	87,95
BR71-5	10	87,95
BR71-6	12	87,95
BR71-7	12,7	128,25
BR71-8	13,5	128,25
BR71-9	14	128,25
BR71-10	15	128,25
BR71-11	16	128,25
BR71-12	17,2	128,25
BR71-13	18	128,25
BR71-14	19	146,75
BR71-15	20	146,75
BR71-16	21,3	146,75
BR71-17	22	146,75
BR71-18	25	146,75
BR71-19	25,4	146,75
BR71-20	26,9	164,50
BR71-21	28	164,50
BR71-22	30	164,50
BR71-23	32	164,50
BR71-24	33,7	193,00
BR71-25	35	193,00
BR71-26	38	193,00
BR71-27	40	193,00
BR71-28	42	193,00
BR71-29	42,4	193,00

Dobbelt rørholder sæt
PP (POLYPROPYLEN) / STÅL

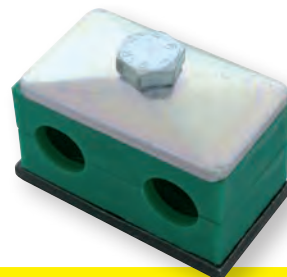

Med svejse- og forplade

Varenr.	ø	DKK
BR71-1-1	6	18,75
BR71-2-1	6,4	18,75
BR71-3-1	8	18,75
BR71-4-1	9,5	18,75
BR71-5-1	10	18,75
BR71-6-1	12	18,75
BR71-7-1	12,7	24,40
BR71-8-1	13,5	24,40
BR71-9-1	14	24,40
BR71-10-1	15	24,40
BR71-11-1	16	24,40
BR71-12-1	17,2	24,40
BR71-13-1	18	24,40
BR71-14-1	19	26,30
BR71-15-1	20	26,30
BR71-16-1	21,3	26,30
BR71-17-1	22	26,30
BR71-18-1	25	26,30
BR71-19-1	25,4	26,30
BR71-20-1	26,9	30,40
BR71-21-1	28	30,40
BR71-22-1	30	30,40
BR71-23-1	32	30,40
BR71-24-1	33,7	38,70
BR71-25-1	35	38,70
BR71-26-1	38	38,70
BR71-27-1	40	38,70
BR71-28-1	42	38,70
BR71-29-1	42,4	38,70

Dobbelt rørholder halvskål PP (POLYPROPYLEN)



Varenr.	ø	DKK
BR71-1A	6	3,35
BR71-2A	6,4	3,35
BR71-3A	8	3,35
BR71-4A	9,5	3,35
BR71-5A	10	3,35
BR71-6A	12	3,35
BR71-7A	12,7	4,10
BR71-8A	13,5 ~ 1/4"	4,10
BR71-9A	14	4,10
BR71-10A	15	4,10
BR71-11A	16	4,10
BR71-12A	17,2 ~ 3/8"	4,10
BR71-13A	18	4,10
BR71-14A	19	4,32
BR71-15A	20	4,32
BR71-16A	21,3 ~ 1/2"	4,32
BR71-17A	22	4,32
BR71-18A	25	4,32
BR71-19A	25,4	4,32
BR71-20A	26,9 ~ 3/4"	5,40
BR71-21A	28	5,40
BR71-22A	30	5,40
BR71-23A	32	5,40
BR71-24A	33,7 ~ 1"	9,05
BR71-25A	35	9,05
BR71-26A	38	9,05
BR71-27A	40	9,05
BR71-28A	42	9,05
BR71-29A	42,4 ~ 1 1/4"	9,05

Dobbelt rørholder svejseplade AISI 316 - MM



Varenr.	dim	DKK
BR71-1-6B	6 - 12	48,35
BR71-7-13B	12,7 - 18	75,65
BR71-14-19B	19 - 25,4	81,90
BR71-20-22B	26,9 - 30	87,65
BR71-23-29B	32 - 42,4	99,95

Sekskantbolt M8 AISI 316 (A4) - MM



Bruges med forplade

Varenr.	dim	L	DKK
BR71-1-6E	6 - 12	35mm	4,10
BR71-7-13E	12,7 - 18	35mm	8,65
BR71-14-19E	19 - 25,4	45mm	10,25
BR71-20-22E	26,9 - 30	50mm	11,05
BR71-23-29E	32 - 42,4	60mm	14,00

NB! BR71-1-6E har M6 gevind.

Dobbelt rørholder forplade AISI 316



Varenr.	dim	DKK
BR71-1-6D	6 - 12	29,00
BR71-7-13D	12,7 - 18	36,15
BR71-14-19D	19 - 25,4	45,20
BR71-20-22D	26,9 - 30	54,55
BR71-23-29D	32 - 42,4	62,00

Dobbelt rørholder svejseplade STÅL - MM



Varenr.	dim	DKK
BR71-1-6G	6 - 12	7,05
BR71-7-13G	12,7 - 18	9,05
BR71-14-19G	19 - 25,4	9,05
BR71-20-22G	26,9 - 30	10,25
BR71-23-29G	32 - 42,4	10,25

Sekskantbolt M8 STÅL - MM



Bruges med forplade

Varenr.	dim	L	DKK
BR71-1-6J	6 - 12	35mm	1,71
BR71-7-13J	12,7 - 18	35mm	3,35
BR71-14-19J	19 - 25,4	45mm	4,10
BR71-20-22J	26,9 - 30	50mm	4,32
BR71-23-29J	32 - 42,4	50mm	4,93

NB! BR71-1-6J har M6 gevind.

Dobbelt rørholder forplade STÅL



Varenr.	dim	DKK
BR71-1-6I	6 - 12	3,35
BR71-7-13I	12,7 - 18	4,10
BR71-14-19I	19 - 25,4	4,66
BR71-20-22I	26,9 - 30	4,93
BR71-23-29I	32 - 42,4	5,40

Rørholder halvskål ALUMINIUM



Varenr.	∅	DKK
BR72-1A	6	41,80
BR72-3A	8	41,80
BR72-5A	10	41,80
BR72-6A	12	41,80
BR72-8A	13,5 ~ 1/4"	44,60
BR72-9A	14	44,60
BR72-10A	15	44,60
BR72-11A	16	44,60
BR72-12A	17,2 ~ 3/8"	44,60
BR72-13A	18	44,60
BR72-14A	19	47,20
BR72-15A	20	47,20
BR72-16A	21,3 ~ 1/2"	47,20
BR72-17A	22	47,20
BR72-18A	25	47,20
BR72-20A	26,9 ~ 3/4"	50,05
BR72-21A	28	50,05
BR72-22A	30	50,05
BR72-23A	32	55,70
BR72-24A	33,7 ~ 1"	55,70
BR72-25A	35	55,70
BR72-26A	38	55,70
BR72-27A	40	55,70
BR72-28A	42	53,10
BR72-29A	42,4 ~ 1 1/4"	55,70
BR72-30A	44,5	61,70
BR72-31A	48,3 ~ 1 1/2"	61,70
BR72-33A	50,8	61,70

Løsdele: se BR68 serien.

Rørholder halvskål XL ALUMINIUM



Varenr.	∅	DKK
BR73-1A	6	113,25
BR73-3A	8	113,25
BR73-4A	9,5	107,75
BR73-5A	10	113,25
BR73-6A	12	113,25
BR73-7A	12,7	113,25
BR73-8A	13,5 ~ 1/4"	113,25
BR73-9A	14	113,25
BR73-10A	15	113,25
BR73-11A	16	113,25
BR73-12A	17,2 ~ 3/8"	113,25
BR73-13A	18	113,25
BR73-14A	19	149,25
BR73-15A	20	149,25
BR73-16A	21,3 ~ 1/2"	149,25
BR73-17A	22	149,25
BR73-18A	25	149,25
BR73-20A	26,9 ~ 3/4"	149,25
BR73-21A	28	149,25
BR73-22A	30	185,00
BR73-23A	32	185,00
BR73-24A	33,7 ~ 1"	185,00
BR73-25A	35	185,00
BR73-26A	38	708,00
BR73-27A	40	708,00
BR73-29A	42,4 ~ 1 1/4"	708,00
BR73-30A	44,5	708,00
BR73-31A	48,3 ~ 1 1/2"	708,00
BR73-32A	50	708,00
BR73-33A	50,8	708,00
BR73-34A	55	708,00
BR73-35A	57	708,00
BR73-36A	60,3 ~ 2"	708,00
BR73-37A	63,5	708,00
BR73-38A	65	1351,50
BR73-39A	70	1351,50
BR73-40A	75	1351,50
BR73-41A	76,1 ~ 2 1/2"	1351,50
BR73-42A	80	1351,50
BR73-44A	88,9 ~ 3"	1351,50

Løsdele: se BR68 serien

Rørholder

STÅL / EPDM - BSPP + MM



1/2" og M8+M10 gevind i fod

Varenr.	ø	DKK
BR117-3	15-19 ~ 3/8"	56,50
BR117-4	20-23 ~ 1/2"	57,85
BR117-5	25-28 ~ 3/4"	58,15
BR117-6	32-35 ~ 1"	59,25
BR117-7	38-43 ~ 1 1/4"	60,35
BR117-8	44-49 ~ 1 1/2"	61,45
BR117-8-2	50-56	62,30
BR117-9	57-63 ~ 2"	63,05
BR117-10	76-80 ~ 2 1/2"	90,90
BR117-11	86-91 ~ 3"	104,50
BR117-12	100-105	113,50
BR117-14	108-116 ~ 4"	122,00
BR117-16	136-139 ~ 5"	184,00
BR117-17	159-168 ~ 6"	192,75

Rørholder

STÅL / EPDM - MM



M8+M10 gevind i fod

Varenr.	ø	DKK
BR115-1	12-14 ~ 1/4"	11,25
BR115-3	15-19 ~ 3/8"	16,20
BR115-4	20-23 ~ 1/2"	17,40
BR115-5	25-30 ~ 3/4"	17,75
BR115-6	31-35 ~ 1"	19,05
BR115-7	40-43 ~ 1 1/4"	20,95
BR115-8	44-49 ~ 1 1/2"	22,80
BR115-9	57-61 ~ 2"	25,55
BR115-10	74-80 ~ 2 1/2"	20,25
BR115-11	86-91 ~ 3"	21,55
BR115-12	100-106 ~ 3 1/2"	35,80
BR115-14	108-116 ~ 4"	41,55
BR115-15	124-132	44,35
BR115-16	133-141 ~ 5"	50,30
BR115-17	159-169 ~ 6"	54,55

Rørholder

STÅL - MM

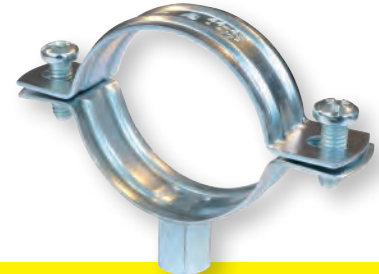

M8+M10 gevind i fod

Varenr.	ø	DKK
BR133-4	20-25 ~ 1/2"	12,90
BR133-5	26-30 ~ 3/4"	13,45
BR133-6	32-36 ~ 1"	13,65
BR133-8	44-49 ~ 1 1/2"	15,95
BR133-9	60-64 ~ 2"	16,85
BR133-10	75-80 ~ 2 1/2"	20,25
BR133-11	85-89 ~ 3"	21,55
BR133-12	99-105 ~ 3 1/2"	23,05
BR133-13	106-112	23,75
BR133-14	113-118 ~ 4"	27,25
BR133-15	125-130	29,30
BR133-16	138-142 ~ 5"	33,55
BR133-17	159-166 ~ 6"	36,40

Rørholder

AISI 316 / EPDM - MM



M8+M10 gevind i fod

Varenr.	ø	DKK
Bi69-3-1	15-18 ~ 3/8"	48,05
Bi69-4-1	20-24 ~ 1/2"	50,05
Bi69-5-1	26-30 ~ 3/4"	51,10
Bi69-6-1	32-36 ~ 1"	53,75
Bi69-7-1	38-42 ~ 1 1/4"	57,90
Bi69-8-1	47-50 ~ 1 1/2"	61,70
Bi69-8-2-1	51-55 ~ 1 1/2"	61,70
Bi69-9-1	60-64 ~ 2"	68,25
Bi69-10-1	75-80 ~ 2 1/2"	88,45
Bi69-11-1	82-92 ~ 3"	96,40
Bi69-12-1	100-106 ~ 3 1/2"	108,75
Bi69-13-1	106-112	114,50
Bi69-14-1	114-119 ~ 4"	117,00
Bi69-15-1	124-131	123,00
Bi69-17-1	159-165 ~ 6"	142,75

Rørholder

AISI 316 - MM



M8+M10 gevind i fod

Varenr.	ø	DKK
Bi69-3	15-18 ~ 3/8"	42,65
Bi69-4	20-24 ~ 1/2"	44,60
Bi69-5	26-30 ~ 3/4"	46,65
Bi69-6	32-36 ~ 1"	48,05
Bi69-7	38-42 ~ 1 1/4"	50,85
Bi69-8	47-50 ~ 1 1/2"	53,75
Bi69-9	60-64 ~ 2"	58,75
Bi69-10	75-80 ~ 2 1/2"	81,65
Bi69-11	82-90 ~ 3"	91,20
Bi69-12	100-103 ~ 3 1/2"	95,55
Bi69-13	106-112	100,75
Bi69-14	114-119 ~ 4"	101,75
Bi69-15	124-131	107,25
Bi69-16	133-140 ~ 5"	113,25
Bi69-17	159-165 ~ 6"	140,50
Bi69-18	199-204	140,50
Bi69-19	215-220 ~ 8"	150,50

Kombiskruer

AISI 304 (A2) - MM



Varenr.	dim	L	DKK
BR603-1	M8	50mm	23,05
BR603-2	M8	100mm	42,05
BR603-3	M10	60mm	39,45
BR603-4	M10	100mm	60,90

Kombiskruer

STÅL - MM



Varenr.	dim	L	DKK
BR329-1	M8	50mm	2,16
BR329-5	M8	80mm	3,35
BR329-10	M10	80mm	4,32
BR329-16	M10	150mm	9,65

Rørholder, stram

AISI 304



Til påsvejsning

Varenr.	ø	Skaft Ø	DKK
BP12-4	13,5	8	128,00
BP12-6	25,4	21,3	109,25
BP12-8	38,1	21,3	112,00
BP12-9	51,0	21,3	119,75
BP12-10	63,5	21,3	133,50
BP12-11	76,2	21,3	139,25
BP12-12	101,6	21,3	152,00

Rørholder, løs

AISI 304



Til påsvejsning

Varenr.	ø	Skaft Ø	DKK
BP12-6L	27,0	21,3	109,25
BP12-8L	40,0	21,3	112,00
BP12-9L	53,0	21,3	119,75
BP12-10L	65,5	21,3	133,50
BP12-11L	78,0	21,3	139,25
BP12-12L	104,0	21,3	152,00

Rørholder tommemål

AISI 304



Til påsvejsning

Varenr.	ø	DKK
BP14-4	21,3	300,00
BP14-5	26,9	191,00
BP14-6	33,7	194,25
BP14-7	42,4	208,75
BP14-8	48,3	119,75
BP14-9	60,3	133,50
BP14-11	88,9	146,25
BP14-12	114	166,75

Rørholder

AISI 316 / EPDM - MM



65 %

DISCOUNT

M8+M10 gevind i fod

Varenr.	ø	DKK
BR153-1	14-15 ~ 1/4"	14,15 ₪
BR153-2	16-19 ~ 3/8"	12,40 ₪
BR153-8	40-43 ~ 1 1/4"	19,50 ₪
BR153-9	48-51 ~ 1 1/2"	20,00 ₪
BR153-11	57-60 ~ 2"	22,55 ₪

₪ = så længe lager haves

Rørholder

STÅL / EPDM - MM



M8+M10 gevind i fod

Varenr.	ø	DKK
BR114-1	12-14 ~ 1/4"	11,35
BR114-2	15-18 ~ 3/8"	17,45
BR114-3	20-23 ~ 1/2"	19,10
BR114-5	25-28 ~ 3/4"	19,30
BR114-6	32-35 ~ 1"	22,15
BR114-8	40-43 ~ 1 1/4"	16,95
BR114-9	44-49 ~ 1 1/2"	19,10
BR114-10	53-56	19,75
BR114-11	57-63 ~ 2"	28,35

Rørholder

ZINK



Varenr.	ø	DKK
BR650-2	1/4"	23,05
BR650-3	3/8"	20,60
BR650-4	1/2"	19,05
BR650-5	3/4"	22,80
BR650-6	1"	25,35
BR650-7	1 1/4"	29,00
BR650-8	1 1/2"	30,70
BR650-9	2"	35,80

Forlænger

ZINK

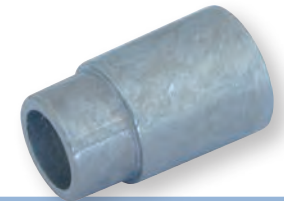

Varenr.	dim	L	DKK
BR651-1	1/2" - 2"	+ 13mm	4,43
BR651-2	1/2" - 2"	+ 16mm	4,43
BR651-3	1/2" - 2"	+ 19mm	4,43
BR651-4	1/4" - 3/8"	+ 21,5mm	4,43

Indlægsdel til BR650

PE (POLYETHYLEN)



Varenr.	Passer til:	Ø rør	DKK
BR652-12	BR650-2	12mm	5,45
BR652-15	BR650-3	15mm	5,45
BR652-18	BR650-4	18mm	5,45
BR652-22	BR650-5	22mm	5,45
BR652-28	BR650-6	28mm	5,45

Rørholder STÅL - MM



M8+M10 gevind i fod

Varenr.	∅	DKK
BR146-1	11-15 ~ 1/4"	3,65 α
BR146-2	16-19 ~ 3/8"	3,20
BR146-3	21-23 ~ 1/2"	3,86
BR146-4	26-28 ~ 3/4"	4,13

α = så længe lager haves

Rørholder STÅL / EPDM



Varenr.	∅	DKK
BR140-11	54	5,25 α
BR140-12	60 ~ 2"	6,00 α

α = så længe lager haves

Rørholder STÅL / EPDM



Varenr.	∅	-	Bolt O	DKK					
BR141-1	5	12	5,3	4,20	BR141-44	22	15	6,4	7,65
BR141-2	6	12	5,3	4,15	BR141-45	23	15	6,4	7,65
BR141-3	8	12	5,3	4,15	BR141-46	25	15	6,4	7,65
BR141-4	10	12	5,3	4,15	BR141-47	26	15	6,4	7,65
BR141-5	12	12	5,3	5,55	BR141-48	28	15	6,4	7,65
BR141-6	13	12	5,3	5,55	BR141-49	30	15	6,4	7,65
BR141-7	14	12	5,3	5,55	BR141-50	32	15	6,4	9,05
BR141-8	15	12	5,3	5,55	BR141-51	34	15	6,4	9,05
BR141-9	16	12	5,3	5,55	BR141-52	35	15	6,4	9,05
BR141-10	17	12	5,3	5,55	BR141-53	37	15	6,4	9,05
BR141-11	18	12	5,3	5,55	BR141-54	38	15	6,4	9,05
BR141-12	19	12	5,3	5,55	BR141-55	40	15	6,4	9,05
BR141-13	20	12	5,3	5,65					
BR141-14	21	12	5,3	6,70	BR141-65	11	20	8,4	9,05
BR141-15	22	12	5,3	6,70	BR141-66	12	20	8,4	9,05
BR141-16	23	12	5,3	6,70	BR141-67	13	20	8,4	9,05
BR141-17	24	12	5,3	6,70	BR141-68	14	20	8,4	9,05
BR141-18	25	12	5,3	6,75	BR141-69	15	20	8,4	9,05
BR141-19	25	12	5,3	6,75	BR141-70	16	20	8,4	9,05
BR141-20	27	12	5,3	6,75	BR141-71	18	20	8,4	9,05
BR141-21	28	12	5,3	6,75	BR141-72	19	20	8,4	9,05
					BR141-73	20	20	8,4	9,05
BR141-31	6	15	6,4	4,54	BR141-74	21	20	8,4	12,10
BR141-32	8	15	6,4	4,54	BR141-75	22	20	8,4	12,40
BR141-33	10	15	6,4	4,54	BR141-76	23	20	8,4	12,40
BR141-34	12	15	6,4	6,05	BR141-77	24	20	8,4	12,40
BR141-35	13	15	6,4	6,05	BR141-78	25	20	8,4	12,40
BR141-36	14	15	6,4	6,05	BR141-79	27	20	8,4	12,40
BR141-37	15	15	6,4	6,05	BR141-80	28	20	8,4	12,40
BR141-38	16	15	6,4	6,05	BR141-81	30	20	8,4	12,40
BR141-39	17	15	6,4	6,05	BR141-82	32	20	8,4	14,90
BR141-40	18	15	6,4	6,05	BR141-83	34	20	8,4	14,90
BR141-41	19	15	6,4	6,05	BR141-84	35	20	8,4	14,90
BR141-42	20	15	6,4	6,05	BR141-85	36	20	8,4	14,90
BR141-43	21	15	6,4	7,65	BR141-86	38	20	8,4	14,90
					BR141-87	40	20	8,4	14,90

Rørholder AISI 304 / EPDM



Varenr.	ø	-	Bolt O	DKK
BR142-1	5	12	5,3	8,05
BR142-2	6	12	5,3	8,05
BR142-3	7	12	5,3	8,05
BR142-4	8	12	5,3	8,05
BR142-5	10	12	5,3	8,05
BR142-6	12	12	5,3	10,70
BR142-7	13	12	5,3	10,70
BR142-8	14	12	5,3	10,70
BR142-9	15	12	5,3	10,70
BR142-10	16	12	5,3	10,70
BR142-11	17	12	5,3	10,70
BR142-13	18	12	5,3	10,70
BR142-14	19	12	5,3	10,70
BR142-15	20	12	5,3	10,70
BR142-16	21	12	5,3	13,35
BR142-17	22	12	5,3	13,35
BR142-18	23	12	5,3	13,35
BR142-19	24	12	5,3	13,35
BR142-20	25	12	5,3	13,35
BR142-21	26	12	5,3	13,35
BR142-22	27	12	5,3	13,35
BR142-23	28	12	5,3	13,35
BR142-33	5	15	6,4	10,70
BR142-34	6	15	6,4	10,70
BR142-35	8	15	6,4	10,70
BR142-36	10	15	6,4	10,70
BR142-37	11	15	6,4	14,00
BR142-38	12	15	6,4	14,00
BR142-39	13	15	6,4	14,00
BR142-40	14	15	6,4	14,00
BR142-41	15	15	6,4	14,00
BR142-42	16	15	6,4	14,00
BR142-43	17	15	6,4	14,00
BR142-44	18	15	6,4	14,00
BR142-45	19	15	6,4	14,00
BR142-46	20	15	6,4	14,00
BR142-47	21	15	6,4	14,60
BR142-48	22	15	6,4	14,60
BR142-49	23	15	6,4	14,60
BR142-50	25	15	6,4	14,60
BR142-51	26	15	6,4	14,60
BR142-52	27	15	6,4	14,60
BR142-53	28	15	6,4	14,60
BR142-54	30	15	6,4	14,60
BR142-55	32	15	6,4	17,40
BR142-56	33	15	6,4	17,40
BR142-57	34	15	6,4	17,40
BR142-58	35	15	6,4	17,40
BR142-59	36	15	6,4	17,40
BR142-60	37	15	6,4	17,40
BR142-61	38	15	6,4	17,40
BR142-62	40	15	6,4	17,40
BR142-63	54	15	6,4	27,85
BR142-64	60	15	6,4	27,85
BR142-74	11	20	8,4	17,75
BR142-75	12	20	8,4	17,75
BR142-76	13	20	8,4	17,75
BR142-77	14	20	8,4	17,75
BR142-78	15	20	8,4	17,75
BR142-79	16	20	8,4	17,75
BR142-80	18	20	8,4	17,75
BR142-81	19	20	8,4	17,75
BR142-82	20	20	8,4	17,75
BR142-83	21	20	8,4	24,40
BR142-84	22	20	8,4	24,40
BR142-85	23	20	8,4	24,40
BR142-86	24	20	8,4	24,40
BR142-87	25	20	8,4	24,40
BR142-88	27	20	8,4	24,40
BR142-89	28	20	8,4	24,40
BR142-91	30	20	8,4	24,40
BR142-92	32	20	8,4	31,05
BR142-93	34	20	8,4	31,05
BR142-94	35	20	8,4	31,05
BR142-95	36	20	8,4	31,05
BR142-96	38	20	8,4	31,05
BR142-97	40	20	8,4	36,70

Rørholder STÅL / EPDM - MM



M6 gevind i fod

Varenr.	ø	DKK
BR134-1	12 ~ 1/4"	1,25 α
BR134-2	14	1,29 α
BR134-3	16 ~ 3/8"	1,33 α
BR134-4	18	1,43 α
BR134-14	60 ~ 2"	3,46 α

α = så længe lager haves

Rørholder dobbelt STÅL / EPDM - MM



M6 gevind i fod

Varenr.	ø	DKK
BR135-2	15 ~ 1/4"	3,01 α
BR135-3	18 ~ 3/8"	3,37 α
BR135-4	22 ~ 1/2"	3,08 α
BR135-5	28 ~ 3/4"	4,78 α

α = så længe lager haves

Rørholder STÅL - MM



M6 gevind i fod

Varenr.	∅	DKK
BR101-1	6	0,75 ₺
BR101-2	8	0,79 ₺
BR101-3	10 ~ 1/8"	0,79 ₺
BR101-4	12 ~ 1/4"	0,83 ₺
BR101-5	14	0,83 ₺
BR101-6	15	0,90 ₺
BR101-7	16	0,90 ₺
BR101-8	18 ~ 3/8"	0,94 ₺
BR101-9	20	0,98 ₺
BR101-11	25	1,07 ₺
BR101-13	28	1,13 ₺
BR101-14	30	1,22 ₺
BR101-15	32 ~ 1"	1,25 ₺
BR101-18	40	1,59 ₺
BR101-19	42 ~ 1 1/4"	1,67 ₺
BR101-20	47 ~ 1 1/2"	1,83 ₺
BR101-22	54	2,09 ₺
BR101-23	60 ~ 2"	2,21 ₺
BR101-25	67	2,64 ₺

₺ = så længe lager haves

Rørholder dobbelt STÅL - MM



M6 gevind i fod

Varenr.	∅	DKK
BR102-1	12 ~ 1/8"	1,51 ₺
BR102-2	14 ~ 1/4"	1,63 ₺
BR102-3	18 ~ 3/8"	1,88 ₺
BR102-4	22 ~ 1/2"	2,09 ₺
BR102-5	28 ~ 3/4"	2,36 ₺

₺ = så længe lager haves

Rørholder STÅL - MM



Varenr.	∅	Bolt	F	H	DKK
BR161-1	17 ~ 3/8"	M6	22	42	3,07
BR161-2	21 ~ 1/2"	M6	22	45	3,35
BR161-3	27 ~ 3/4"	M6	30	56	3,69
BR161-4	34 ~ 1"	M6	30	61	4,10
BR161-5	42 ~ 1 1/4"	M8	35	74	7,65
BR161-6	49 ~ 1 1/2"	M8	35	79	9,05
BR161-7	60 ~ 2"	M8	35	89	10,25
BR161-8	76 ~ 2 1/2"	M8	45	115	12,65
BR161-9	90 ~ 3"	M10	45	121	20,25
BR161-11	114 ~ 4"	M10	55	165	26,60
BR161-12	140 ~ 5"	M10	55	188	35,25
BR161-13	168 ~ 6"	M10	55	215	43,75
BR161-14	220 ~ 8"	M10	45	268	54,55

F=gevindlængde, H=totalhøjde

Rørholder AISI 304 - MM



Varenr.	∅	Gevind	DKK
BR163-2	18 ~ 3/8"	6	12,80
BR163-3	22 ~ 1/2"	6	13,60
BR163-4	28 ~ 3/4"	6	15,10
BR163-5	34 ~ 1"	6	16,00
BR163-6	38	6	16,00
BR163-7	43 ~ 1 1/4"	6	16,60
BR163-8	49 ~ 1 1/2"	8	19,20
BR163-9	53	8	28,70
BR163-10	54	8	38,15
BR163-11	61 ~ 2"	8	38,15
BR163-12	66	8	42,00
BR163-13	77 ~ 2 1/2"	8	45,40
BR163-14	85	8	48,45
BR163-15	90 ~ 3"	8	48,45
BR163-16	105	10	91,20
BR163-17	115 ~ 4"	10	96,40
BR163-18	130	10	109,50
BR163-19	144 ~ 5"	10	119,00
BR163-20	155	10	123,25
BR163-21	170 ~ 6"	10	128,75
BR163-22	206	10	146,25

Rørholder STÅL - MM



Varenr.	∅	Gevind	DKK
BR123-3	15-18 ~ 3/8"	M8	7,35 ₺
BR123-4	20-24 ~ 1/2"	M8	7,45 ₺
BR123-5	26-30 ~ 3/4"	M8	7,65 ₺
BR123-6	32-36 ~ 1"	M8	8,55 ₺
BR123-7	38-42 ~ 1 1/4"	M8	9,45 ₺
BR123-8	47-50 ~ 1 1/2"	M8	9,95 ₺
BR123-9	51-55	M8	11,35 ₺
BR123-10	60-64 ~ 2"	M8	13,95 ₺
BR123-11	75-80 ~ 2 1/2"	M10	16,85 ₺

₺ = så længe lager haves

Rørholder STÅL



Varenr.	∅	-	- -	DKK
BR160-1	12 ~ 1/4"	12	1.2	3,15 ₺
BR160-2	15	12	1.2	3,30 ₺
BR160-3	18 ~ 3/8"	12	1.2	3,37 ₺
BR160-4	22 ~ 1/2"	12	1.2	3,50 ₺
BR160-6	28	12	1.2	3,73 ₺
BR160-8	35	12	1.2	3,93 ₺
BR160-9	42 ~ 1 1/4"	12	1.2	4,78 ₺
BR160-11	54	15	1.2	5,45 ₺

₺ = så længe lager haves

Rørholder AISI 316



Varenr.	∅	-	- -	DKK
BR180-1	10 ~ 1/8"	12	1	2,78
BR180-2	12 ~ 1/4"	12	1	3,24
BR180-3	15	15	1	3,46
BR180-4	18	15	1	4,43
BR180-5	20 ~ 1/2"	15	1	5,10
BR180-6	22	15	1	6,35
BR180-7	25 ~ 3/4"	15	1	6,65
BR180-8	28	15	1	6,65
BR180-9	32 ~ 1"	18	1	8,30

Rørholder AISI 316



Varenr.	∅	-	- -	DKK
BR181-1	15 ~ 3/8"	12	1	4,20
BR181-2	18	15	1	5,75
BR181-3	20 ~ 1/2"	15	1	6,00
BR181-4	22	15	1	6,95
BR181-5	28	18	1	7,75
BR181-6	32 ~ 1"	18	1	9,65
BR181-8	50		1	14,90

Skrue AISI 304



Varenr.	dim	DKK
Bi72-1	4,8 × 32	2,04

Skrue STÅL



Varenr.	dim	DKK
BR327-8	5 × 35	,79

Rørholder STÅL



Varenr.	∅	-	- -	DKK
BR103-01	6	12	1.2	,79
BR103-10	8	12	1.2	,79
BR103-1	10 ~ 1/8"	12	1.2	,79
BR103-2	12 ~ 1/4"	12	1.2	,91
BR103-11	14	12	1.2	1,03
BR103-3	15	12	1.2	1,03
BR103-12	16 ~ 3/8"	12	1.2	1,13
BR103-4	18	15	1.2	1,42
BR103-5	20 ~ 1/2"	15	1.2	1,42
BR103-6	22	15	1.2	1,59
BR103-7	25	15	1.2	1,59
BR103-13	26 ~ 3/4"	15	1.2	2,04
BR103-14	30	18	1.2	2,27
BR103-9	32 ~ 1"	18	1.2	2,04
BR103-18	47 ~ 1 1/2"	18	1.2	4,43 α

Rørholder STÅL



Varenr.	∅	-	- -	DKK
BR104-10	8	12	1.2	1,13 α
BR104-11	10 ~ 1/8"	12	1.2	1,13 α
BR104-12	13 ~ 1/4"	12	1.2	1,30 α
BR104-13	14	12	1.2	1,42
BR104-1	15	12	1.2	1,42 α
BR104-14	17 ~ 3/8"	12	1.2	1,71
BR104-2	18	12	1.2	1,71 α
BR104-3	21 ~ 1/2"	15	1.2	1,82
BR104-4	22	15	1.2	2,47
BR104-15	25	15	1.2	2,27
BR104-16	27 ~ 3/4"	15	1.2	2,67
BR104-5	28	15	1.2	2,16
BR104-17	30	15	1.2	3,46 α
BR104-6	34 ~ 1"	15	1.2	3,02
BR104-20	48 ~ 1 1/2"	15	1.2	5,25
BR104-22	60 ~ 2"	15	1.2	6,45

α = så længe lager haves

Rørholder STÅL



Varenr.	∅	DKK
BR127-2	10 ~ 1/8"	1,73 α
BR127-3	12 ~ 1/4"	1,83 α

α = så længe lager haves

Patentbånd

AISI 316

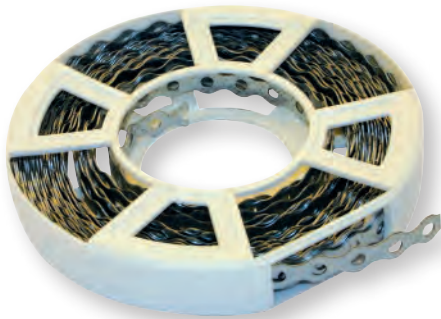

Varenr.	-	- -	L	DKK
BR320-1	12	0,8	10m	385,00
BR320-2	17	0,8	10m	553,25
BR320-3	26	1	10m	1099,25

Patentbånd

ALUMINIUM

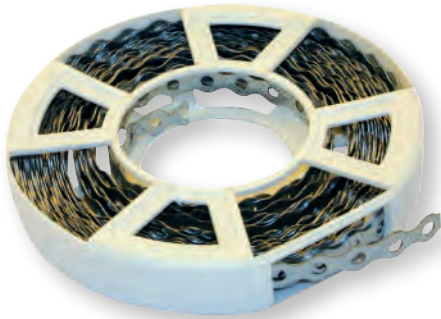

Varenr.	-	- -	L	DKK
BR319-1	12	1	10m	123,75
BR319-2	17	1	10m	140,50

Patentbånd

GALVANISERET

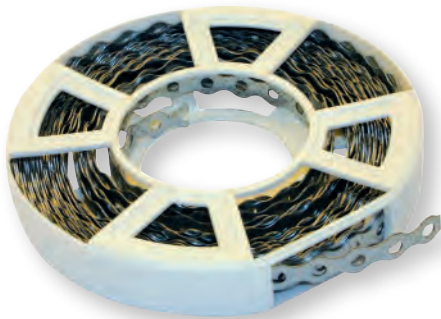

Varenr.	-	- -	L	DKK
BR317-1	12	0,8	10m	70,15
BR317-2	17	0,8	10m	95,55
BR317-3	26	1	10m	193,00

Rørholder til PVC rør

PP (POLYPROPYLEN)



Varenr.	ø	U	DKK
BR214-20	20	-	7,45
BR214-25	25	-	8,40
BR214-32	32	-	9,45
BR214-40	40	-	20,00
BR214-50	50	+	25,55
BR214-63	63	+	28,70
BR214-75	75	+	37,50
BR214-90	90	+	47,45
BR214-110	110	+	54,80

U = låsebøjle

Rørholder

PA (POLYAMID)



Varenr.	ø	DKK
BR220-1	12 ~ 1/4"	4,20
BR220-2	15	4,54
BR220-4	18	5,85
BR220-5	20 ~ 1/2"	6,45
BR220-6	22	6,95
BR220-7	25	7,65
BR220-8	28	8,30
BR220-9	32 ~ 1"	8,90
BR220-11	40	13,35
BR220-12	50	14,00

Rørholder

PE (POLYETHYLEN)



Varenr.	ø	DKK
J1-1	6	8,90
J1-2	8	8,10
J1-3	10	12,10
J1-4	12	13,65
J1-5	15	15,20

Rørholder

PP (POLYPROPYLEN)

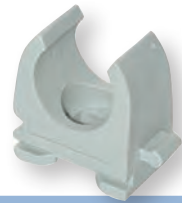

Varenr.	ø	DKK
J2-3	18 - 19	2,36 α
J2-5	22 - 23	2,81 α

α = så længe lager haves. J2-3 = PA

Rørholder

POM (ACETAL)



M6 gevind, indvendig montage

Varenr.	ø	DKK
BR212-1	8	4,32
BR212-2	10 ~ 1/8"	4,43
BR212-3	12 ~ 1/4"	4,54
BR212-4	15 ~ 3/8"	4,77
BR212-5	16-18	6,35
BR212-6	20-22 ~ 1/2"	6,65
BR212-8	28 ~ 3/4"	7,05
BR212-10	35	9,20
BR212-11	42 ~ 1 1/4"	9,90

Rørholder

POM (ACETAL)



M6 gevind, indvendig montage

Varenr.	ø	DKK
BR225-4	15 ~ 3/8"	1,67 α
BR225-5	16-18	2,16 α
BR225-7	28 ~ 3/4"	2,45 α
BR225-8	35	3,37 α
BR225-9	42 ~ 1 1/4"	3,73 α

α = så længe lager haves

Rørholder dobbelt

POM (ACETAL)



M6 gevind, indvendig montage

Varenr.	∅	DKK
BR213-1	8	7,65
BR213-2	10 ~ 1/8"	7,75
BR213-3	12 ~ 1/4"	7,90
BR213-4	15 ~ 3/8"	8,75
BR213-5	18	11,70
BR213-6	22 ~ 1/2"	12,20
BR213-7	28 ~ 3/4"	14,60

Rørholder dobbelt

POM (ACETAL)

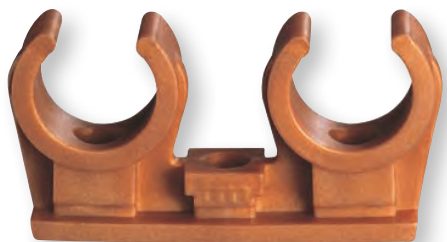

M6 gevind, indvendig montage

Varenr.	∅	DKK
BR226-1	8	6,75
BR226-2	10 ~ 1/8"	6,85
BR226-3	12 ~ 1/4"	7,75
BR226-5	16-18	11,25
BR226-6	20-22 ~ 1/2"	11,70
BR226-7	28 ~ 3/4"	15,45

Rørholder

POM (ACETAL)



Varenr.	∅	Bredde	DKK
BR363-1	12	25	3,35
BR363-2	15-18	29	3,46
BR363-4	20-25	37	3,99
BR363-5	25-28	44	4,74
BR363-6	28-32	48	7,05
BR363-7	35-42	60	7,55
BR363-8	50	75	8,40

Så længe lager haves

Rørholder

PP (POLYPROPYLEN)



Varenr.	∅	DKK
BR201-1	12 ~ 1/4"	2,38
BR201-2	16 ~ 3/8"	2,78
BR201-3	18	3,24
BR201-4	20 ~ 1/2"	3,57
BR201-7	28 ~ 3/4"	4,77
BR201-9	35	6,10
BR201-10	40	7,75
BR201-11	50	11,15

Rørholder

PP (POLYPROPYLEN)



Rørholder grå

PP (POLYPROPYLEN)



Varenr.	∅	DKK
BR373-1	14	1,29 ₺
BR373-2	18	1,29 ₺
BR373-5	28	1,33 ₺

₺ = så længe lager haves

Rørholder sort

PP (POLYPROPYLEN)



Varenr.	∅	DKK
BR374-1	14	1,29 ₺
BR374-2	18	1,29 ₺
BR374-5	28	1,33 ₺

₺ = så længe lager haves

Bolt FZB

STÅL - MM



Varenr.	Str.	L	DKK
BR328-1	M6	16	1,13
BR328-2	M6	20	1,42
BR328-3	M6	25	1,59
BR328-4	M8	15	2,27
BR328-5	M8	20	2,38
BR328-6	M8	25	2,55
BR328-7	M10	20	4,43
BR328-8	M10	25	5,10
BR328-9	M10	30	5,25
BR328-10	M12	25	7,25
BR328-11	M12	30	7,45
BR328-12	M12	35	8,40

Møtrik

STÅL - MM



Varenr.	dim	DIN	DKK
BR323-1	M4	934	0,29
BR323-2	M5	934	0,34
BR323-3	M6	934	0,39
BR323-4	M8	934	0,74
BR323-5	M10	934	1,82
BR323-6	M12	934	2,38

Spændeskive

STÅL



Varenr.	dim	DIN	DKK
BR324-1	M4	125	0,23
BR324-2	M5	125	0,29
BR324-3	M6	125	0,34
BR324-4	M8	125	0,39
BR324-5	M10	125	0,69
BR324-6	M12	125	1,08
BR324-7	M6	9021	0,50
BR324-8	M8	9021	1,08
BR324-9	M10	9021	1,82
BR324-10	M12	9021	3,35

Forlænger M6

MESSING - MM



Varenr.	L	DKK
BR309-2	15mm	1,97 ₺
BR309-3	20mm	2,04 ₺
BR309-4	30mm	2,16 ₺
BR309-6	50mm	2,49 ₺
BR309-7	60mm	2,98 ₺
BR309-8	70mm	3,65 ₺
BR309-9	80mm	4,22 ₺
BR309-10	90mm	4,42 ₺
BR309-11	100mm	4,95 ₺

₺ = så længe lager havet

Muffe

AISI 304 - MM



Varenr.	dim	L	DKK
BR570-1	M8	30mm	26,00
BR570-2	M10	30mm	28,40

Muffe

STÅL - MM



Varenr.	dim	L	DKK
BR307-1	M6	20mm	3,69
BR307-4	M8	30mm	4,93
BR307-5	M10	30mm	6,95
BR307-6	M12	30mm	13,65

Gevindstang

STÅL - MM



Varenr.	dim	L	DKK
BR322-1	M4	1000mm	5,65
BR322-2	M5	1000mm	8,00
BR322-3	M6	20mm	1,03
BR322-4	M6	30mm	1,30
BR322-5	M6	1000mm	14,50
BR322-6	M8	20mm	1,59
BR322-7	M8	30mm	2,04
BR322-8	M8	1000mm	22,75
BR322-9	M10	30mm	3,07
BR322-10	M10	1000mm	35,85
BR322-11	M12	30mm	5,25
BR322-12	M12	1000mm	49,95

Flange til rørholder

AISI 316 - MM



Varenr.	dim	DKK
Bi68-6	M8	26,30
Bi68-7	M10	27,85

Basemål: 20x70mm

Gevindstang

AISI 316 (A4) - MM



Varenr.	dim	L	DKK
BR321-1	M4	1000mm	47,75
BR321-2	M5	1000mm	43,05
BR321-3	M6	1000mm	44,70
BR321-4	M8	1000mm	88,75
BR321-5	M10	1000mm	137,25
BR321-6	M12	1000mm	200,75

Montagebeslag

STÅL



Varenr.	L	O dim.	DKK
BR334-2	90° =55mm	10x25	11,05
BR334-1	45° =88mm	10x25	9,65

Flange til rørholder

STÅL - MM



Varenr.	dim	O	DKK
BR335-1	M8/M10	×2	18,30
BR335-2	1/2"	×2	23,85
BR335-3	1/2"	×3	35,25

Gevindstang

AISI 304 (A2) - MM



Varenr.	dim	L	DKK
BR325-1	M4	1000mm	27,15
BR325-2	M5	1000mm	28,40
BR325-3	M6	1000mm	29,05
BR325-4	M8	1000mm	52,45
BR325-5	M10	1000mm	79,75
BR325-6	M12	1000mm	109,75

Glidestop

STÅL - MM



Varenr.	dim	Skinne	DKK
BR334A-1	M6x20	27/18-28/30	3,03 ₺
BR334A-2	M8x20	27/18-28/30	3,46 ₺
BR334A-4	M10x30	27/18-28/30	4,88 ₺
BR334A-5	M8x30	38/40	5,50 ₺
BR334A-6	M10x30	38/40	6,60 ₺

₺ = så længe lager havet

BOLTE & SKRUER



Rustfri og alm. stål bolte og møtrikker i et komplet program, typisk fra metrisk gevind M3 til metrisk gevind M24.

Sætskrue DIN 933

AISI 316 (A4)



Varenr.	Str.	L	DKK	Varenr.	Str.	L	DKK	Varenr.	Str.	L	DKK
BR1-M03-005	M3	5	1,46	BR1-M05-022	M5	22	2,13	BR1-M06-080	M6	80	4,92
BR1-M03-006	M3	6	0,83	BR1-M05-025	M5	25	1,70	BR1-M06-090	M6	90	6,65
BR1-M03-008	M3	8	0,91	BR1-M05-030	M5	30	1,93	BR1-M06-100	M6	100	8,45
BR1-M03-010	M3	10	0,99	BR1-M05-035	M5	35	2,47	BR1-M08-010	M8	10	4,18
BR1-M03-012	M3	12	1,14	BR1-M05-040	M5	40	2,38	BR1-M08-012	M8	12	3,53
BR1-M03-016	M3	16	1,32	BR1-M05-045	M5	45	3,04	BR1-M08-014	M8	14	3,44
BR1-M03-020	M3	20	0,89	BR1-M05-050	M5	50	3,97	BR1-M08-016	M8	16	3,23
BR1-M03-025	M3	25	1,75	BR1-M05-070	M5	70	6,80	BR1-M08-018	M8	18	3,63
BR1-M04-006	M4	6	1,33	BR1-M05-080	M5	80	8,30	BR1-M08-020	M8	20	3,56
BR1-M04-008	M4	8	1,32	BR1-M06-008	M6	8	2,11	BR1-M08-022	M8	22	5,15
BR1-M04-010	M4	10	1,09	BR1-M06-010	M6	10	1,58	BR1-M08-025	M8	25	4,04
BR1-M04-012	M4	12	1,24	BR1-M06-012	M6	12	1,58	BR1-M08-030	M8	30	4,47
BR1-M04-016	M4	16	1,12	BR1-M06-014	M6	14	1,78	BR1-M08-035	M8	35	6,05
BR1-M04-020	M4	20	1,24	BR1-M06-016	M6	16	1,38	BR1-M08-040	M8	40	5,75
BR1-M04-025	M4	25	1,63	BR1-M06-018	M6	18	2,30	BR1-M08-045	M8	45	6,35
BR1-M04-030	M4	30	1,68	BR1-M06-020	M6	20	1,93	BR1-M08-050	M8	50	6,35
BR1-M04-035	M4	35	2,43	BR1-M06-022	M6	22	2,80	BR1-M08-055	M8	55	6,40
BR1-M04-040	M4	40	2,31	BR1-M06-025	M6	25	2,17	BR1-M08-060	M8	60	8,90
BR1-M04-050	M4	50	3,24	BR1-M06-030	M6	30	2,11	BR1-M08-065	M8	65	8,10
BR1-M05-006	M5	6	2,00	BR1-M06-035	M6	35	2,33	BR1-M08-070	M8	70	8,80
BR1-M05-008	M5	8	1,75	BR1-M06-040	M6	40	2,58	BR1-M08-075	M8	75	11,75
BR1-M05-010	M5	10	1,13	BR1-M06-045	M6	45	2,97	BR1-M08-080	M8	80	11,45
BR1-M05-012	M5	12	1,22	BR1-M06-050	M6	50	3,52	BR1-M08-090	M8	90	9,55
BR1-M05-014	M5	14	1,61	BR1-M06-055	M6	55	4,16	BR1-M08-100	M8	100	11,75
BR1-M05-016	M5	16	1,41	BR1-M06-060	M6	60	3,58	BR1-M08-120	M8	120	16,75
BR1-M05-018	M5	18	1,86	BR1-M06-065	M6	65	4,96				
BR1-M05-020	M5	20	1,28	BR1-M06-070	M6	70	4,90				
				BR1-M06-075	M6	75	7,20				

Sætskrue DIN 933

AISI 316 (A4)



Varenr.	Str.	L	DKK
BR1-M10-012	M10	12	11,85
BR1-M10-014	M10	14	9,55
BR1-M10-016	M10	16	6,10
BR1-M10-018	M10	18	7,95
BR1-M10-020	M10	20	6,20
BR1-M10-022	M10	22	6,50
BR1-M10-025	M10	25	7,25
BR1-M10-030	M10	30	7,65
BR1-M10-035	M10	35	8,30
BR1-M10-040	M10	40	9,25
BR1-M10-045	M10	45	10,55
BR1-M10-050	M10	50	10,55
BR1-M10-055	M10	55	11,20
BR1-M10-060	M10	60	11,95
BR1-M10-065	M10	65	11,75
BR1-M10-070	M10	70	13,45
BR1-M10-080	M10	80	15,30
BR1-M10-090	M10	90	16,40
BR1-M10-100	M10	100	16,10
BR1-M10-110	M10	110	32,40
BR1-M10-120	M10	120	22,95
BR1-M10-130	M10	130	24,60
BR1-M10-140	M10	140	40,50
BR1-M12-016	M12	16	13,40
BR1-M12-020	M12	20	9,45
BR1-M12-025	M12	25	10,40
BR1-M12-030	M12	30	13,05
BR1-M12-035	M12	35	11,95
BR1-M12-040	M12	40	14,55
BR1-M12-045	M12	45	16,90
BR1-M12-050	M12	50	15,10
BR1-M12-055	M12	55	16,90
BR1-M12-060	M12	60	20,50
BR1-M12-065	M12	65	19,05
BR1-M12-070	M12	70	17,35
BR1-M12-080	M12	80	25,95
BR1-M12-090	M12	90	24,10
BR1-M12-100	M12	100	26,20
BR1-M12-110	M12	110	31,55
BR1-M12-120	M12	120	33,10
BR1-M12-130	M12	130	49,65
BR1-M12-140	M12	140	42,20
BR1-M14-025	M14	25	17,25
BR1-M14-030	M14	30	18,95
BR1-M14-035	M14	35	19,20

Sætskrue DIN 933

AISI 316 (A4)



BR1-M14-040	M14	40	19,55
BR1-M14-045	M14	45	23,45
BR1-M14-050	M14	50	23,70
BR1-M14-055	M14	55	25,20
BR1-M14-060	M14	60	25,25
BR1-M14-065	M14	65	37,90
BR1-M14-070	M14	70	30,55
BR1-M14-080	M14	80	41,60
BR1-M14-090	M14	90	48,20
BR1-M14-100	M14	100	44,25
BR1-M16-025	M16	25	23,20
BR1-M16-030	M16	30	25,75
BR1-M16-035	M16	35	24,90
BR1-M16-040	M16	40	33,60
BR1-M16-045	M16	45	31,60
BR1-M16-050	M16	50	30,90
BR1-M16-055	M16	55	34,65
BR1-M16-060	M16	60	34,75
BR1-M16-065	M16	65	38,80
BR1-M16-070	M16	70	40,00
BR1-M16-080	M16	80	37,50
BR1-M16-090	M16	90	64,95
BR1-M16-100	M16	100	60,05
BR1-M16-110	M16	110	56,25
BR1-M16-120	M16	120	66,10
BR1-M16-150	M16	150	79,75
BR1-M18-040	M18	40	33,45
BR1-M20-030	M20	30	33,85
BR1-M20-035	M20	35	45,65
BR1-M20-040	M20	40	48,40
BR1-M20-045	M20	45	49,45
BR1-M20-050	M20	50	54,60
BR1-M20-055	M20	55	55,70
BR1-M20-060	M20	60	60,90
BR1-M20-065	M20	65	65,30
BR1-M20-070	M20	70	76,70
BR1-M20-080	M20	80	74,80
BR1-M20-090	M20	90	75,10
BR1-M20-100	M20	100	89,60
BR1-M20-120	M20	120	114,00
BR1-M20-140	M20	140	128,75
BR1-M20-160	M20	160	196,00
BR1-M20-180	M20	180	215,50
BR1-M20-200	M20	200	236,00

Varenr.	Str.	L	DKK
BR1-M24-040	M24	40	106,00
BR1-M24-045	M24	45	104,25
BR1-M24-050	M24	50	113,75
BR1-M24-055	M24	55	122,00
BR1-M24-060	M24	60	117,00
BR1-M24-065	M24	65	95,05
BR1-M24-070	M24	70	111,00
BR1-M24-075	M24	75	168,00
BR1-M24-080	M24	80	124,50
BR1-M24-090	M24	90	116,50
BR1-M24-100	M24	100	143,00
BR1-M24-110	M24	110	164,25
BR1-M24-120	M24	120	175,75

Bolt Unbrako DIN 912

AISI 316 (A4)



Varenr.	Str.	L	DKK	Varenr.	Str.	L	DKK
BR2-M02-003	M2	3	0,98	BR2-M04-060	M4	60	4,16
BR2-M02-004	M2	4	0,79	BR2-M04-070	M4	70	6,25
BR2-M02-005	M2	5	0,89	BR2-M04-080	M4	80	14,50
BR2-M02-006	M2	6	0,97	BR2-M05-006	M5	6	2,59
BR2-M02-008	M2	7	1,02	BR2-M05-008	M5	8	1,58
BR2-M02-010	M2	10	1,31	BR2-M05-010	M5	10	1,14
BR2-M02-012	M2	12	2,28	BR2-M05-012	M5	12	1,39
BR2-M02-016	M2	16	2,54	BR2-M05-014	M5	14	1,50
BR2-M025-005	M2,5	5	0,95	BR2-M05-016	M5	16	1,53
BR2-M025-006	M2,5	6	1,01	BR2-M05-018	M5	18	1,99
BR2-M025-008	M2,5	8	1,15	BR2-M05-020	M5	20	1,79
BR2-M025-010	M2,5	10	1,31	BR2-M05-022	M5	22	2,08
BR2-M025-012	M2,5	12	1,48	BR2-M05-025	M5	25	1,90
BR2-M025-016	M2,5	16	2,40	BR2-M05-030	M5	30	2,34
BR2-M025-020	M2,5	20	3,10	BR2-M05-035	M5	35	2,69
BR2-M03-004	M3	4	1,51	BR2-M05-040	M5	40	2,88
BR2-M03-005	M3	5	0,82	BR2-M05-045	M5	45	3,53
BR2-M03-006	M3	6	0,60	BR2-M05-050	M5	50	3,88
BR2-M03-008	M3	8	0,57	BR2-M05-055	M5	55	4,96
BR2-M03-010	M3	10	0,61	BR2-M05-060	M5	60	4,41
BR2-M03-012	M3	12	0,66	BR2-M05-070	M5	70	6,10
BR2-M03-016	M3	16	0,72	BR2-M05-080	M5	80	8,30
BR2-M03-020	M3	20	1,14	BR2-M06-008	M6	8	3,04
BR2-M03-022	M3	22	1,32	BR2-M06-010	M6	10	1,70
BR2-M03-025	M3	25	1,46	BR2-M06-012	M6	12	1,72
BR2-M03-030	M3	30	1,43	BR2-M06-014	M6	14	2,16
BR2-M03-035	M3	35	2,11	BR2-M06-016	M6	16	1,79
BR2-M03-040	M3	40	2,51	BR2-M06-020	M6	20	2,22
BR2-M04-006	M4	6	1,03	BR2-M06-022	M6	22	2,54
BR2-M04-008	M4	8	0,95	BR2-M06-025	M6	25	2,58
BR2-M04-010	M4	10	1,03	BR2-M06-030	M6	30	2,87
BR2-M04-012	M4	12	1,03	BR2-M06-035	M6	35	3,45
BR2-M04-014	M4	14	1,28	BR2-M06-040	M6	40	3,81
BR2-M04-016	M4	16	1,24	BR2-M06-045	M6	45	8,20
BR2-M04-020	M4	20	1,35	BR2-M06-050	M6	50	4,69
BR2-M04-025	M4	25	1,47	BR2-M06-055	M6	55	5,10
BR2-M04-030	M4	30	1,94	BR2-M06-060	M6	60	6,00
BR2-M04-035	M4	35	2,07	BR2-M06-065	M6	65	6,40
BR2-M04-040	M4	40	2,30	BR2-M06-070	M6	70	5,90
BR2-M04-045	M4	45	3,47	BR2-M06-080	M6	80	6,85
BR2-M04-050	M4	50	3,80	BR2-M06-090	M6	90	9,00
				BR2-M06-100	M6	100	10,45

Bolt Unbrako DIN 912

AISI 316 (A4)



Varenr.	Str.	L	DKK				
BR2-M08-010	M8	10	6,45	BR2-M12-050	M12	50	18,15
BR2-M08-012	M8	12	3,62	BR2-M12-060	M12	60	18,20
BR2-M08-016	M8	16	3,42	BR2-M12-065	M12	65	21,75
BR2-M08-020	M8	20	4,44	BR2-M12-070	M12	70	22,65
BR2-M08-025	M8	25	4,62	BR2-M12-080	M12	80	23,00
BR2-M08-030	M8	30	5,25	BR2-M12-090	M12	90	30,30
BR2-M08-035	M8	35	6,30	BR2-M12-100	M12	100	36,95
BR2-M08-040	M8	40	7,00	BR2-M12-110	M12	110	36,40
BR2-M08-045	M8	45	6,45	BR2-M12-120	M12	120	43,70
BR2-M08-050	M8	50	8,30	BR2-M12-140	M12	140	52,05
BR2-M08-055	M8	55	7,55	BR2-M14-060	M14	60	34,70
BR2-M08-060	M8	60	9,25	BR2-M14-070	M14	70	68,50
BR2-M08-070	M8	70	10,20	BR2-M16-030	M16	30	27,70
BR2-M08-075	M8	75	11,60	BR2-M16-035	M16	35	31,10
BR2-M08-080	M8	80	13,10	BR2-M16-040	M16	40	33,30
BR2-M08-090	M8	90	16,15	BR2-M16-045	M16	45	34,55
BR2-M08-100	M8	100	18,20	BR2-M16-050	M16	50	53,80
BR2-M08-120	M8	120	20,90	BR2-M16-055	M16	55	41,10
BR2-M08-130	M8	130	26,25	BR2-M16-060	M16	60	54,05
BR2-M10-012	M10	12	12,50	BR2-M16-070	M16	70	61,15
BR2-M10-016	M10	16	6,60	BR2-M16-080	M16	80	67,20
BR2-M10-020	M10	20	7,65	BR2-M16-090	M16	90	75,35
BR2-M10-025	M10	25	8,45	BR2-M16-100	M16	100	80,85
BR2-M10-030	M10	30	8,65	BR2-M16-110	M16	110	84,65
BR2-M10-035	M10	35	8,50	BR2-M16-120	M16	120	100,25
BR2-M10-040	M10	40	10,15	BR2-M16-140	M16	140	176,75
BR2-M10-045	M10	45	12,00	BR2-M16-150	M16	150	178,00
BR2-M10-050	M10	50	12,10	BR2-M20-040	M20	40	66,90
BR2-M10-055	M10	55	13,00	BR2-M20-045	M20	45	78,90
BR2-M10-060	M10	60	12,80	BR2-M20-050	M20	50	86,80
BR2-M10-065	M10	65	15,80	BR2-M20-060	M20	60	137,25
BR2-M10-070	M10	70	16,30	BR2-M20-065	M20	65	117,25
BR2-M10-075	M10	75	17,50	BR2-M20-070	M20	70	106,00
BR2-M10-080	M10	80	17,85	BR2-M20-080	M20	80	118,00
BR2-M10-090	M10	90	22,05	BR2-M20-090	M20	90	130,50
BR2-M10-100	M10	100	22,40	BR2-M20-100	M20	100	186,25
BR2-M10-120	M10	120	28,70	BR2-M20-110	M20	110	198,75
BR2-M10-130	M10	130	39,00	BR2-M20-120	M20	120	214,25
BR2-M12-016	M12	16	14,25	BR2-M24-050	M24	50	330,00
BR2-M12-020	M12	20	10,10	BR2-M24-060	M24	60	314,25
BR2-M12-025	M12	25	11,30	BR2-M24-070	M24	70	399,25
BR2-M12-030	M12	30	17,15	BR2-M24-080	M24	80	341,50
BR2-M12-035	M12	35	14,30	BR2-M24-090	M24	90	478,00
BR2-M12-040	M12	40	13,35	BR2-M24-100	M24	100	518,00
BR2-M12-045	M12	45	16,65				

Maskinskrue Unbrako DIN 7991

AISI 316 (A4)



Varenr.	Str.	L	DKK				
BR3-M03-006	M3	6	0,35	BR3-M08-045	M8	45	6,65
BR3-M03-008	M3	8	0,44	BR3-M08-050	M8	50	7,45
BR3-M03-010	M3	10	0,53	BR3-M08-060	M8	60	8,50
BR3-M03-012	M3	12	0,66	BR3-M08-070	M8	70	10,10
BR3-M03-016	M3	16	0,70	BR3-M08-080	M8	80	12,00
BR3-M03-018	M3	18	1,14	BR3-M08-100	M8	100	18,75
BR3-M03-020	M3	20	0,87	BR3-M10-016	M10	16	5,30
BR3-M03-025	M3	25	1,05	BR3-M10-020	M10	20	5,45
BR3-M04-006	M4	6	0,87	BR3-M10-025	M10	25	5,95
BR3-M04-008	M4	8	0,96	BR3-M10-030	M10	30	6,35
BR3-M04-010	M4	10	0,68	BR3-M10-035	M10	35	7,80
BR3-M04-012	M4	12	0,70	BR3-M10-040	M10	40	7,95
BR3-M04-016	M4	16	0,87	BR3-M10-050	M10	50	10,95
BR3-M04-020	M4	20	0,99	BR3-M10-060	M10	60	11,75
BR3-M04-025	M4	25	1,12	BR3-M10-070	M10	70	15,00
BR3-M04-030	M4	30	1,51	BR3-M10-080	M10	80	15,40
BR3-M04-035	M4	35	2,12	BR3-M10-150	M10	150	52,20
BR3-M04-040	M4	40	2,33	BR3-M12-020	M12	20	16,00
BR3-M05-008	M5	8	1,67	BR3-M12-025	M12	25	11,90
BR3-M05-010	M5	10	1,10	BR3-M12-030	M12	30	10,60
BR3-M05-012	M5	12	1,12	BR3-M12-035	M12	35	12,65
BR3-M05-016	M5	16	1,22	BR3-M12-040	M12	40	12,80
BR3-M05-020	M5	20	1,42	BR3-M12-045	M12	45	16,20
BR3-M05-025	M5	25	1,80	BR3-M12-050	M12	50	16,95
BR3-M05-030	M5	30	2,11	BR3-M12-060	M12	60	19,40
BR3-M05-035	M5	35	2,90	BR3-M12-070	M12	70	25,55
BR3-M05-040	M5	40	2,98	BR3-M12-080	M12	80	28,50
BR3-M05-050	M5	50	4,03	BR3-M12-100	M12	100	39,75
BR3-M06-010	M6	10	1,52	BR3-M16-030	M16	30	57,60
BR3-M06-012	M6	12	1,62	BR3-M16-035	M16	35	55,25
BR3-M06-014	M6	14	1,45	BR3-M16-040	M16	40	51,75
BR3-M06-016	M6	16	1,46	BR3-M16-050	M16	50	36,30
BR3-M06-020	M6	20	1,66	BR3-M16-060	M16	60	42,40
BR3-M06-025	M6	25	2,04	BR3-M16-070	M16	70	52,85
BR3-M06-030	M6	30	2,40	BR3-M16-080	M16	80	58,75
BR3-M06-035	M6	35	2,77	BR3-M16-100	M16	100	107,75
BR3-M06-040	M6	40	3,42	BR3-M20-040	M20	40	163,50
BR3-M06-050	M6	50	3,64	BR3-M20-045	M20	45	272,25
BR3-M06-060	M6	60	5,55	BR3-M20-050	M20	50	153,25
BR3-M06-070	M6	70	6,20	BR3-M20-055	M20	55	130,25
BR3-M08-012	M8	12	2,87	BR3-M20-060	M20	60	115,00
BR3-M08-016	M8	16	3,55	BR3-M20-070	M20	70	84,40
BR3-M08-020	M8	20	2,95	BR3-M20-080	M20	80	195,00
BR3-M08-025	M8	25	3,67	BR3-M20-090	M20	90	242,25
BR3-M08-030	M8	30	3,92	BR3-M20-100	M20	100	247,00
BR3-M08-035	M8	35	4,54				
BR3-M08-040	M8	40	4,87				

Møtrik DIN 934

AISI 316 (A4)



Varenr.	Str.	DKK
BR5-M02	M2	0,16
BR5-M025	M2,5	0,20
BR5-M03	M3	0,22
BR5-M04	M4	0,27
BR5-M05	M5	0,31
BR5-M06	M6	0,60
BR5-M08	M8	1,32
BR5-M10	M10	2,78
BR5-M12	M12	4,25
BR5-M14	M14	6,35
BR5-M16	M16	8,45
BR5-M18	M18	15,45
BR5-M20	M20	15,70
BR5-M22	M22	27,00
BR5-M24	M24	32,70

Planskive DIN 125A

AISI 316 (A4)



Varenr.	Str.	dim	- -	DKK
BR7-M02	M2	2,2 × 5	0,3	0,14
BR7-M025	M2,5	2,7 × 6	0,5	0,10
BR7-M03	M3	3,2 × 7	0,5	0,12
BR7-M04	M4	4,3 × 9	0,8	0,14
BR7-M05	M5	5,3 × 10	1	0,18
BR7-M06	M6	6,4 × 12	1,6	0,33
BR7-M08	M8	8,4 × 16	1,6	0,60
BR7-M10	M10	10,5 × 20	2	1,11
BR7-M12	M12	13 × 24	2,5	2,00
BR7-M14	M14	15 × 28	2,5	2,81
BR7-M16	M16	17 × 30	3	3,45
BR7-M18	M18	19 × 34	3	6,70
BR7-M20	M20	21 × 37	3	5,30
BR7-M22	M22	23 × 39	3	9,00
BR7-M24	M24	25 × 44	4	11,80

Fjederskive DIN 127B

AISI 316 (A4)



Varenr.	Str.	dim	- -	DKK
BR9-M02	M2	2,1 × 4,4	0,8	0,50
BR9-M03	M3	3,1 × 6,2	0,8	0,08
BR9-M04	M4	4,1 × 7,6	0,9	0,11
BR9-M05	M5	5,1 × 9,2	1,2	0,19
BR9-M06	M6	6,1 × 11,8	0,6	0,29
BR9-M08	M8	8,1 × 14,8	2	0,52
BR9-M10	M10	10,2 × 18,1	2,2	0,80
BR9-M12	M12	12,2 × 21,1	2,5	1,23
BR9-M14	M14	14,2 × 24,1	3,0	2,20
BR9-M16	M16	16,2 × 27,4	3,5	2,91
BR9-M18	M18	18,2 × 29,4	3,5	4,01
BR9-M20	M20	20,2 × 33,6	4	5,05
BR9-M24	M24	24,5 × 40	5	10,10

Låsemøtrik DIN 985

AISI 316 (A4)



Varenr.	Str.	DKK
BR6-M03	M3	0,48
BR6-M04	M4	0,49
BR6-M05	M5	0,57
BR6-M06	M6	0,68
BR6-M08	M8	1,50
BR6-M10	M10	3,21
BR6-M12	M12	4,78
BR6-M14	M14	10,60
BR6-M16	M16	11,90
BR6-M18	M18	28,45
BR6-M20	M20	27,85
BR6-M22	M22	183,00
BR6-M24	M24	55,40

Skærmskive DIN 9021

AISI 316 (A4)



Varenr.	Str.	dim	- -	DKK
BR8-M025	M2,5	2,7 × 8	0,8	0,20
BR8-M03	M3	3,2 × 9	0,8	0,23
BR8-M04	M4	4,3 × 12	1	0,26
BR8-M05	M5	5,3 × 15	1,2	0,48
BR8-M06	M6	6,4 × 18	1,6	0,87
BR8-M08	M8	8,4 × 24	2	1,81
BR8-M10	M10	10,5 × 30	2,5	3,53
BR8-M12	M12	13 × 37	3	6,80
BR8-M14	M14	15 × 44	3	9,35
BR8-M16	M16	17 × 50	3	11,85
BR8-M18	M18	20 × 56	4	28,10
BR8-M20	M20	22 × 60	4	26,05
BR8-M24	M24	26 × 72	5	43,65

Schnorr skive

AISI 304 (A2)



Varenr.	Str.	dim	- -	DKK
BR10-M05	M5	5,0 × 9	0,6	0,54
BR10-M06	M6	6,4 × 10	0,7	0,62
BR10-M08	M8	8,4 × 13	0,8	0,88
BR10-M10	M10	10,5 × 16	1,0	1,26
BR10-M12	M12	13 × 18	1,1	1,71
BR10-M14	M14	15 × 22	1,2	2,33
BR10-M16	M16	17 × 24	1,3	2,97
BR10-M18	M18	19 × 27	1,6	5,80
BR10-M20	M20	21 × 30	1,5	6,60
BR10-M22	M22	23 × 33	1,5	7,80
BR10-M24	M24	25,6 × 36	1,8	10,70

Stjerneskeive DIN 6798A

AISI 316 (A4)



Varenr.	Str.	DKK
BR11-M025	M2,5	0,14
BR11-M03	M3	0,14
BR11-M04	M4	0,18
BR11-M05	M5	0,25
BR11-M06	M6	0,31
BR11-M08	M8	0,52
BR11-M10	M10	0,68
BR11-M12	M12	0,89
BR11-M14	M14	1,83
BR11-M16	M16	4,11
BR11-M20	M20	3,09

Låsering indvendig DIN 472

AISI 304 (A2)



Varenr.	Str.	DKK
BR12-M08	M8	3,13
BR12-M09	M9	6,25
BR12-M10	M10	3,19
BR12-M11	M11	7,85
BR12-M12	M12	5,20
BR12-M13	M13	4,45
BR12-M14	M14	4,40
BR12-M15	M15	3,88
BR12-M16	M16	4,72
BR12-M17	M17	5,55
BR12-M18	M18	4,36
BR12-M19	M19	7,70
BR12-M20	M20	5,40
BR12-M21	M21	6,45
BR12-M22	M22	6,40
BR12-M23	M23	13,50
BR12-M24	M24	11,45

Pinolskrue m. krater DIN 916

AISI 316 (A4)



Varenr.	Str.	L	DKK
BR13-M03-003	M3	3	1,90
BR13-M03-004	M3	4	0,74
BR13-M03-005	M3	5	0,65
BR13-M03-006	M3	6	0,71
BR13-M03-008	M3	8	0,72
BR13-M03-010	M3	10	0,85
BR13-M03-012	M3	12	4,89
BR13-M03-016	M3	16	1,27
BR13-M03-020	M3	20	4,16
BR13-M04-004	M4	4	0,56
BR13-M04-005	M4	5	0,47
BR13-M04-006	M4	6	0,49
BR13-M04-008	M4	8	0,58
BR13-M04-010	M4	10	0,74
BR13-M04-012	M4	12	0,79
BR13-M04-016	M4	16	1,06
BR13-M04-020	M4	20	1,23
BR13-M04-025	M4	25	1,56
BR13-M05-005	M5	5	0,52
BR13-M05-006	M5	6	0,57
BR13-M05-008	M5	8	0,57
BR13-M05-010	M5	10	0,82
BR13-M05-012	M5	12	1,02
BR13-M05-016	M5	16	1,31
BR13-M05-020	M5	20	1,63
BR13-M05-025	M5	25	2,00
BR13-M05-030	M5	30	2,44
BR13-M05-035	M5	35	2,67
BR13-M06-006	M6	6	0,79
BR13-M06-008	M6	8	0,89
BR13-M06-010	M6	10	1,22
BR13-M06-012	M6	12	1,37
BR13-M06-016	M6	16	1,81
BR13-M06-020	M6	20	2,06
BR13-M06-025	M6	25	2,60
BR13-M06-030	M6	30	3,13
BR13-M06-035	M6	35	3,61
BR13-M06-040	M6	40	12,80
BR13-M06-050	M6	50	11,00
BR13-M08-008	M8	8	1,75
BR13-M08-010	M8	10	1,84
BR13-M08-012	M8	12	2,17
BR13-M08-016	M8	16	2,90
BR13-M08-020	M8	20	3,41
BR13-M08-025	M8	25	4,57
BR13-M08-030	M8	30	5,25
BR13-M08-035	M8	35	6,20
BR13-M08-040	M8	40	8,40
BR13-M08-050	M8	50	13,05
BR13-M10-010	M10	10	2,72
BR13-M10-012	M10	12	3,24
BR13-M10-016	M10	16	3,78
BR13-M10-020	M10	20	5,25
BR13-M10-025	M10	25	6,75
BR13-M10-030	M10	30	8,15
BR13-M10-035	M10	35	9,65
BR13-M10-040	M10	40	12,65
BR13-M10-050	M10	50	22,70
BR13-M12-012	M12	12	5,25
BR13-M12-016	M12	16	6,45
BR13-M12-020	M12	20	8,50
BR13-M12-025	M12	25	10,25
BR13-M12-030	M12	30	12,70
BR13-M12-040	M12	40	19,20
BR13-M12-045	M12	45	30,50
BR13-M12-050	M12	50	75,35
BR13-M16-025	M16	25	24,90
BR13-M16-030	M16	30	28,85
BR13-M16-040	M16	40	41,80
BR13-M16-050	M16	50	65,55

Makinskrue POZ DIN 965

AISI 316 (A4)



Varenr.	Str.	L	DKK
BR14-M02-004	M2	4	0,19
BR14-M02-005	M2	5	0,22
BR14-M02-006	M2	6	0,24
BR14-M02-008	M2	8	0,27
BR14-M02-010	M2	10	0,29
BR14-M02-012	M2	12	0,31
BR14-M02-016	M2	16	0,37
BR14-M02-020	M2	20	0,44
BR14-M025-004	M2,5	4	0,39
BR14-M025-005	M2,5	5	1,82
BR14-M025-006	M2,5	6	0,35
BR14-M025-008	M2,5	8	0,35
BR14-M025-010	M2,5	10	0,37
BR14-M025-012	M2,5	12	0,39
BR14-M025-016	M2,5	16	0,47
BR14-M025-020	M2,5	20	0,74
BR14-M03-004	M3	4	0,46
BR14-M03-005	M3	5	0,36
BR14-M03-006	M3	6	0,35
BR14-M03-008	M3	8	0,37
BR14-M03-010	M3	10	0,35
BR14-M03-012	M3	12	0,43
BR14-M03-014	M3	14	0,91
BR14-M03-016	M3	16	0,54
BR14-M03-020	M3	20	0,61
BR14-M03-025	M3	25	0,69
BR14-M03-030	M3	30	0,89
BR14-M04-006	M4	6	0,57
BR14-M04-008	M4	8	0,59
BR14-M04-010	M4	10	0,61
BR14-M04-012	M4	12	0,63
BR14-M04-014	M4	14	0,74
BR14-M04-016	M4	16	0,67
BR14-M04-020	M4	20	0,89
BR14-M04-025	M4	25	1,02
BR14-M04-030	M4	30	1,27
BR14-M04-035	M4	35	1,35

Makinskrue TORX DIN 965

AISI 316 (A4)



Varenr.	Str.	L	DKK
BR14-M04-040	M4	40	1,68
BR14-M04-050	M4	50	2,39
BR14-M04-080	M4	80	3,70
BR14-M05-006	M5	6	,92
BR14-M05-008	M5	8	1,57
BR14-M05-010	M5	10	1,03
BR14-M05-012	M5	12	1,19
BR14-M05-016	M5	16	1,06
BR14-M05-020	M5	20	1,43
BR14-M05-025	M5	25	1,46
BR14-M05-030	M5	30	1,90
BR14-M05-035	M5	35	1,99
BR14-M05-040	M5	40	2,19
BR14-M05-045	M5	45	3,13
BR14-M05-050	M5	50	3,33
BR14-M05-060	M5	60	3,61
BR14-M06-010	M6	10	1,37
BR14-M06-012	M6	12	1,41
BR14-M06-016	M6	16	1,83
BR14-M06-020	M6	20	2,15
BR14-M06-025	M6	25	2,21
BR14-M06-030	M6	30	2,69
BR14-M06-035	M6	35	3,56
BR14-M06-040	M6	40	3,83
BR14-M06-045	M6	45	4,31
BR14-M06-050	M6	50	4,72
BR14-M06-060	M6	60	5,65
BR14-M08-016	M8	16	α
BR14-M08-020	M8	20	α
BR14-M08-025	M8	25	α
BR14-M08-030	M8	30	α
BR14-M08-035	M8	35	α
BR14-M08-040	M8	40	α
BR14-M08-045	M8	45	α
BR14-M08-050	M8	50	α
α = spørg på pris			
BR15-M02-006	M2	6	0,29
BR15-M02-008	M2	8	0,32
BR15-M025-005	M2,5	5	0,33
BR15-M025-006	M2,5	6	0,34
BR15-M025-008	M2,5	8	0,35
BR15-M025-010	M2,5	10	0,37
BR15-M025-012	M2,5	12	0,39
BR15-M025-016	M2,5	16	0,48
BR15-M025-020	M2,5	20	0,63
BR15-M025-025	M2,5	25	0,99
BR15-M03-006	M3	6	0,36
BR15-M03-008	M3	8	0,37
BR15-M03-010	M3	10	0,37
BR15-M03-012	M3	12	0,42
BR15-M03-014	M3	14	0,56
BR15-M03-016	M3	16	0,52
BR15-M03-020	M3	20	0,66
BR15-M03-025	M3	25	0,78
BR15-M03-030	M3	30	1,34
BR15-M03-035	M3	35	1,08
BR15-M04-008	M4	8	0,70
BR15-M04-012	M4	12	0,68
BR15-M04-016	M4	16	0,99
BR15-M04-020	M4	20	0,83
BR15-M04-025	M4	25	1,06
BR15-M04-030	M4	30	1,50
BR15-M04-035	M4	35	1,42
BR15-M04-040	M4	40	2,03
BR15-M04-050	M4	50	2,52
BR15-M04-055	M4	55	2,58
BR15-M05-006	M5	6	1,07
BR15-M05-008	M5	8	1,15
BR15-M05-010	M5	10	0,96
BR15-M05-012	M5	12	0,98
BR15-M05-016	M5	16	1,22
BR15-M05-020	M5	20	1,93
BR15-M05-030	M5	30	2,44
BR15-M06-008	M6	8	1,79
BR15-M06-012	M6	12	1,65

Split DIN 94

AISI 316 (A4)



Varenr.	Ø	L	DKK
BR16-M016-010	1,6	10	0,36
BR16-M016-016	1,6	16	0,38
BR16-M016-020	1,6	20	0,43
BR16-M016-025	1,6	25	0,63
BR16-M016-032	1,6	32	0,76
BR16-M02-010	2	10	0,41
BR16-M02-012	2	12	0,43
BR16-M02-016	2	16	0,46
BR16-M02-020	2	20	0,57
BR16-M02-025	2	25	0,63
BR16-M02-032	2	32	0,78
BR16-M02-036	2	36	0,83
BR16-M02-040	2	40	0,95
BR16-M025-016	2,5	16	0,80
BR16-M025-020	2,5	20	0,89
BR16-M025-025	2,5	25	0,97
BR16-M025-032	2,5	32	1,14
BR16-M025-036	2,5	36	1,31
BR16-M025-040	2,5	40	1,46
BR16-M025-050	2,5	50	1,88
BR16-M032-016	3,2	16	0,94
BR16-M032-020	3,2	20	1,15
BR16-M032-025	3,2	25	1,34
BR16-M032-032	3,2	32	1,58
BR16-M032-036	3,2	36	1,67
BR16-M032-040	3,2	40	1,90
BR16-M032-050	3,2	50	2,19
BR16-M04-020	4	20	2,16
BR16-M04-025	4	25	2,43
BR16-M04-032	4	32	2,70
BR16-M04-036	4	36	3,28

BR16-M04-040	4	40	3,33
BR16-M04-050	4	50	3,88
BR16-M04-063	4	63	4,68
BR16-M05-025	5	25	4,06
BR16-M05-028	5	28	4,48
BR16-M05-032	5	32	4,97
BR16-M05-036	5	36	5,35
BR16-M05-040	5	40	5,85
BR16-M05-050	5	50	7,10
BR16-M05-063	5	63	8,70
BR16-M05-071	5	71	9,90
BR16-M05-100	5	100	13,60
BR16-M063-032	6,3	32	6,85
BR16-M063-034	6,3	34	6,95
BR16-M063-036	6,3	36	7,50
BR16-M063-040	6,3	40	9,70
BR16-M063-050	6,3	50	10,70
BR16-M063-063	6,3	63	11,80
BR16-M063-071	6,3	71	14,25
BR16-M063-080	6,3	80	13,20
BR16-M063-100	6,3	100	18,35
BR16-M08-040	8	40	16,00
BR16-M08-050	8	50	19,90
BR16-M08-063	8	63	23,35
BR16-M08-071	8	71	25,10
BR16-M08-080	8	80	26,65
BR16-M08-100	8	100	33,70
BR16-M10-071	10	71	160,75
BR16-M10-125	10	125	174,75

Bolt FZB

STÅL - MM



Varenr.	Str.	L	DKK
BR328-1	M6	16	1,13
BR328-2	M6	20	1,42
BR328-3	M6	25	1,59
BR328-4	M8	15	2,27
BR328-5	M8	20	2,38
BR328-6	M8	25	2,55
BR328-7	M10	20	4,43
BR328-8	M10	25	5,10
BR328-9	M10	30	5,25
BR328-10	M12	25	7,25
BR328-11	M12	30	7,45
BR328-12	M12	35	8,40

Møtrik

STÅL - MM



Varenr.	dim	DIN	DKK
BR323-1	M4	934	0,29
BR323-2	M5	934	0,34
BR323-3	M6	934	0,39
BR323-4	M8	934	0,74
BR323-5	M10	934	1,82
BR323-6	M12	934	2,38

Spændeskive

STÅL



Varenr.	dim	DIN	DKK
BR324-1	M4	125	0,23
BR324-2	M5	125	0,29
BR324-3	M6	125	0,34
BR324-4	M8	125	0,39
BR324-5	M10	125	0,69
BR324-6	M12	125	1,08
BR324-7	M6	9021	0,50
BR324-8	M8	9021	1,08
BR324-9	M10	9021	1,82
BR324-10	M12	9021	3,35

Gevindstang

AISI 316 (A4) - MM

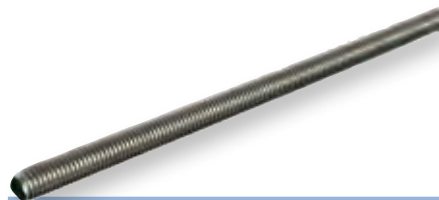

Varenr.	dim	L	DKK
BR321-1	M4	1000mm	47,75
BR321-2	M5	1000mm	43,05
BR321-3	M6	1000mm	44,70
BR321-4	M8	1000mm	88,75
BR321-5	M10	1000mm	137,25
BR321-6	M12	1000mm	200,75

Gevindstang

AISI 304 (A2) - MM



Varenr.	dim	L	DKK
BR325-1	M4	1000mm	27,15
BR325-2	M5	1000mm	28,40
BR325-3	M6	1000mm	29,05
BR325-4	M8	1000mm	52,45
BR325-5	M10	1000mm	79,75
BR325-6	M12	1000mm	109,75

Gevindstang

STÅL - MM



Varenr.	dim	L	DKK
BR322-1	M4	1000mm	5,65
BR322-2	M5	1000mm	8,00
BR322-3	M6	20mm	1,03
BR322-4	M6	30mm	1,30
BR322-5	M6	1000mm	14,50
BR322-6	M8	20mm	1,59
BR322-7	M8	30mm	2,04
BR322-8	M8	1000mm	22,75
BR322-9	M10	30mm	3,07
BR322-10	M10	1000mm	35,85
BR322-11	M12	30mm	5,25
BR322-12	M12	1000mm	49,95

STRIPS



-40°C til +85°C



Kabelbindere, strips, bruges overalt i elektriske installationer; både i boligen og industrien.

Vi lagerfører strips i mange forskellige størrelser og farver. Brug de sorte strips udenfor, de er UV bestandige.

Materiale: Polyamid (PA 6)

Temp: -40°C til +85°C

Karakteristika:

- god kombination af styrke, stivhed og hårdhed
- høj slidstyrke
- god kemikalieresistens

Kemikaliebestandig over for:

- olieprodukter, benzin, fedtstoffer, smøremidler og opløsningsmidler som alkohol, ketoner, ester og ether

Ikke bestandig over for:

- mange syrer, stærke baser og oxidationsmidler
- klorbaserede produkter

Strips sælges kun i poser à 100 styk, men bemærk at priserne er stykpriser.

Strips, hvid

PA (POLYAMID)

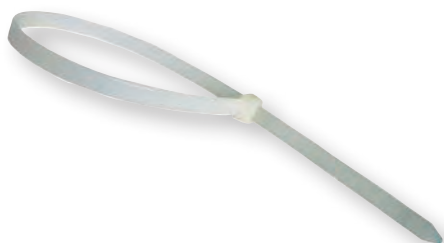

NB! Sælges kun i poser à 100 stk!

Varenr.	L	-	DKK/stk
H1-1	80	2,4	0,16 □
H1-2	100	2,5	0,16
H1-4	120	4,8	0,50
H1-5	140	2,5	0,23
H1-6	140	3,6	0,34 □
H1-7	150	3,6	0,39
H1-8	150	7,6	1,08
H1-9	160	2,5	0,29
H1-10	160	4,8	0,50
H1-11	180	3,6	0,50
H1-12	190	4,8	0,58 □
H1-13	200	2,5	0,34
H1-14	200	3,6	0,50
H1-15	200	4,8	0,58
H1-16	200	7,6	1,37
H1-17	216	4,8	0,79
H1-18	240	12,6	4,10
H1-19	250	2,8	0,58
H1-20	250	3,6	0,69

H1-21	250	4,8	0,79
H1-22	250	7,6	1,82
H1-23	266	4,8	0,85
H1-24	280	4,8	0,85
H1-25	300	2,8	0,74
H1-26	300	3,6	0,69
H1-27	300	4,8	0,97 □
H1-28	300	7,6	1,82
H1-29	300	12,6	6,40
H1-30	370	3,6	1,13
H1-31	370	4,8	1,13 □
H1-32	370	7,6	2,21
H1-33	390	4,8	1,71
H1-34	390	12,6	6,80
H1-35	430	4,8	1,82
H1-36	430	7,6	3,69
H1-37	430	9,0	3,46
H1-38	450	4,8	3,02
H1-39	490	12,6	6,95
H1-40	530	4,8	3,46
H1-41	530	7,6	4,38

H1-42	530	9,0	4,20
H1-43	550	4,8	3,80
H1-44	590	12,6	8,85
H1-45	610	9,0	5,60
H1-46	635	4,8	4,38
H1-47	685	4,8	4,49
H1-48	710	9,0	6,35
H1-49	730	4,8	4,88
H1-50	740	12,6	8,95
H1-51	780	9,0	6,95
H1-52	830	9,0	8,75
H1-53	840	12,6	11,85
H1-54	890	12,6	13,30
H1-55	920	9,0	9,15
H1-56	1020	9,0	11,40
H1-57	1040	12,6	13,40
H1-58	1070	9,0	12,00
H1-59	1220	9,0	13,40
H1-60	1530	9,0	18,55

□ = altid på lager i større mængder

Strips sort PA (POLYAMID)



NB! Sælges kun i poser à 100 stk!			
Varenr.	L	-	DKK/stk
H2-1	80	2,4	0,16 α
H2-2	100	2,5	0,16
H2-4	120	4,8	0,50
H2-5	140	2,5	0,23
H2-6	140	3,6	0,34 α
H2-7	150	3,6	0,39
H2-8	150	7,6	1,08
H2-9	160	2,5	0,29
H2-10	160	4,8	0,50
H2-12	190	4,8	0,58 α
H2-13	200	2,5	0,34
H2-14	200	3,6	0,50
H2-15	200	4,8	0,58
H2-16	200	7,6	1,37
H2-17	216	4,8	0,79
H2-18	240	12,6	4,10
H2-19	250	2,8	0,53
H2-20	250	3,6	0,69
H2-21	250	4,8	0,79
H2-22	250	7,6	1,82
H2-23	266	4,8	0,85
H2-24	280	4,8	0,85
H2-25	300	2,8	0,74
H2-26	300	3,6	0,69
H2-27	300	4,8	0,97 α
H2-28	300	7,6	1,82
H2-29	300	12,6	6,40
H2-30	370	3,6	1,13

H2-31	370	4,8	1,13 α
H2-32	370	7,6	2,21
H2-33	390	4,8	1,71
H2-34	390	12,6	6,80
H2-35	430	4,8	1,82
H2-36	430	7,6	3,69
H2-37	430	9,0	3,46
H2-38	450	4,8	3,02
H2-39	490	12,6	6,95
H2-40	530	4,8	3,46
H2-41	530	7,6	4,38
H2-42	530	9,0	4,20
H2-43	550	4,8	3,80
H2-44	590	12,6	8,85
H2-46	635	4,8	4,38
H2-47	685	4,8	4,49
H2-48	710	9,0	6,35
H2-49	730	4,8	4,88
H2-50	740	12,6	8,95
H2-51	780	9,0	6,95
H2-52	830	9,0	8,75
H2-53	840	12,6	11,85
H2-54	890	12,6	13,30
H2-55	920	9,0	9,15
H2-56	1020	9,0	11,40
H2-57	1040	12,6	13,40
H2-58	1070	9,0	12,00
H2-59	1220	9,0	13,40
H2-60	1530	9,0	18,55

α = altid på lager i større mængder

Strips, grøn PA (POLYAMID)



NB! Sælges kun i poser à 100 stk!			
Varenr.	L	-	DKK/stk
H3-2	100	2,5	0,16
H3-5	160	2,5	0,22
H3-6	140	3,6	0,33
H3-10	160	4,8	0,49
H3-14	200	3,6	0,49
H3-15	200	4,8	0,55
H3-21	250	4,8	0,76
H3-27	300	4,8	0,93
H3-30	370	3,6	1,09
H3-31	370	4,8	1,09
H3-33	390	4,8	1,64

Strips, gul PA (POLYAMID)

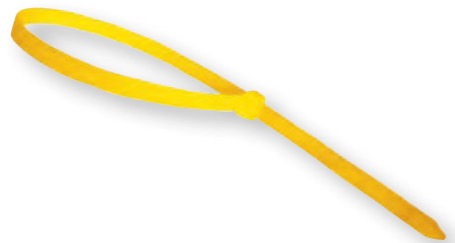

NB! Sælges kun i poser à 100 stk!			
Varenr.	L	-	DKK/stk
H4-2	100	2,5	0,16
H4-5	160	2,5	0,22
H4-6	140	3,6	0,33
H4-10	160	4,8	0,49
H4-14	200	3,6	0,49
H4-15	200	4,8	0,55
H4-21	250	4,8	0,76
H4-27	300	4,8	0,93
H4-30	370	3,6	1,09
H4-31	370	4,8	1,09
H4-33	390	4,8	1,64

Strips, blå

PA (POLYAMID)

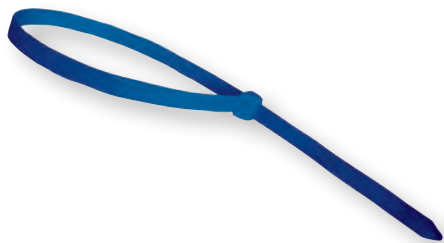

NB! Sælges kun i poser à 100 stk!

Varenr.	L	-	DKK/stk
H5-2	100	2,5	0,16
H5-5	160	2,5	0,22
H5-6	140	3,6	0,33
H5-10	160	4,8	0,49
H5-14	200	3,6	0,49
H5-15	200	4,8	0,55
H5-21	250	4,8	0,76
H5-27	300	4,8	0,93
H5-30	370	3,6	1,09
H5-31	370	4,8	1,09
H5-33	390	4,8	1,64

Strips, rød

PA (POLYAMID)

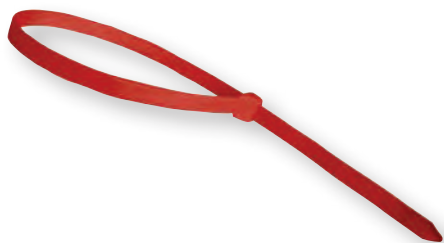

NB! Sælges kun i poser à 100 stk!

Varenr.	L	-	DKK/stk
H6-2	100	2,5	0,16
H6-5	160	2,5	0,22
H6-6	140	3,6	0,33
H6-10	160	4,8	0,49
H6-14	200	3,6	0,49
H6-15	200	4,8	0,55
H6-21	250	4,8	0,76
H6-27	300	4,8	0,93
H6-30	370	3,6	1,09
H6-31	370	4,8	1,09
H6-33	390	4,8	1,64

LAD OS HØRE FRA DIG

ROYKON AS har bred erfaring i levering af specialkomponenter i rustfri og messing. Vi kan tilbyde serier fra 100 til mange 100.000 enheder.

De fabrikker, vi får produceret på, besøges i gennemsnit en gang om året. Vi har igennem årene haft et langt udskillelsesløb, hvor de fabrikker, vi bruger i dag, er fabrikker med meget høje standarder og kvalitetskrav.

Vi tilbyder at give en hurtig pris på dine specialkomponenter og på pro-

duktionssiden betyder det, at vi i udviklingsfasen har lynhurtig tilbagemelding og at kvaliteten af produkterne er, som vores kunder har specificeret.

Vores leverandører er miljøbeviste, benytter ikke børnearbejde og har ordnede forhold for alle medarbejdere.

Således føler vi os nu rustet til at levere kvalitetsfittings til virksomheder, for hvem kvalitet er en selvfølge og hvor miljø og social bevidsthed har betydning.

**RING FOR ET
UFORPLIGTENDE
BESØG PÅ TELEFON:**

75 945 955



SLANGEFITTINGS & SLANGER



497 SLANGEFITTINGS
RUSTFRI



500 SLANGEFITTINGS
MESSING



505 SLANGEFITTINGS
GALVANISERET



506 SLANGEFITTINGS
NYLON



510 SLANGEFITTINGS
PVDF



512 SLANGEFITTINGS
NYLON NATURAL



514 SLANGEFITTINGS PP



520 SLANGEFITTINGS PP
GLASFIBER FORSTÆRKET



521 PAKNINGER



523 SLANGER TIL
VAND/LUFT



530 SLANGER TIL
TRYKLUFT



533 SLANGER TIL
VÆSKE/VAND



535 SLANGER TIL
VAKUUM OG TRYK



537 SLANGER TIL AFLØB
& FORURENEDE VÆSKER



538 SLANGER TIL SVØMME-
BASSIN & SANITET



539 SLANGER TIL BRAND/
ENTREPRENØR

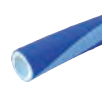

540 SLANGER TIL
FØDEVARER/KEMI



542 SLANGER TIL DAMP



543 SLANGER TIL OLIE



544 SLANGER TILBEHØR

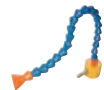

548 SLANGER TIL
KØLEVÆSKE

LAD OS HØRE FRA DIG

FITTINGS SPECIALISTEN AS har bred erfaring i levering af specialkomponenter i rustfri og messing. Vi kan tilbyde serier fra 100 til mange 100.000 enheder.

De fabrikker, vi får produceret på, besøges i gennemsnit en gang om året. Vi har igennem årene haft et langt udskillelsesløb, hvor de fabrikker, vi bruger i dag, er fabrikker med meget høje standarder og kvalitetskrav.

Vi tilbyder at give en hurtig pris på dine specialkomponenter og på produkti-

onssiden betyder det, at vi i udviklingsfasen har lynhurtig tilbagemelding og at kvaliteten af produkterne er, som vores kunder har specificeret.

Vores leverandører er miljøbeviste, benytter ikke børnearbejde og har ordnede forhold for alle medarbejdere.

Således føler vi os nu rustet til at levere kvalitetsfittings til virksomheder, for hvem kvalitet er en selvfølge og hvor miljø og social bevidsthed har betydning.

**RING FOR ET
UFORPLIGTENDE
BESØG PÅ TELEFON:**

75 945 955

SLANGEFITTINGS & SLANGER



SLANGEFITTINGS RUSTFRI



Se tekst



-10°C til +80°C



Bredt program af slangefittings i rustfri stål, AISI 316 og AISI 304.

Tryk: max 10bar

- enkelte kan dog tage meget højere tryk, forhør nærmere, hvis du skal bruge slangefittings til højere tryk end 10bar.

Slangenippel

AISI 316 - BSPT



Varenr.	Ø × BSPT	DKK
B14-1-6	6 × 1/8"	56,25
B14-2	6 × 1/4"	44,60
B14-4-6	6 × 1/2"	95,55
B14-1-7	7 × 1/8"	35,25
B14-3-7	7 × 3/8"	78,10
B14-1-8	8 × 1/8"	56,25
B14-2-8	8 × 1/4"	64,95
B14-3-8	8 × 3/8"	78,10
B14-4-8	8 × 1/2"	95,55
B14-2-9	9 × 1/4"	64,95
B14-1-10	10 × 1/8"	86,80
B14-2-10	10 × 1/4"	64,95
B14-3	10 × 3/8"	53,75
B14-4-10	10 × 1/2"	95,55
B14-2-11	11 × 1/4"	64,95
B14-3-13	13 × 3/8"	78,10
B14-4	13 × 1/2"	64,95

B14-4-14	14 × 1/2"	95,55
B14-3-16	16 × 3/8"	78,10
B14-4-16	16 × 1/2"	95,55
B14-5-16	16 × 3/4"	145,75
B14-4-19	19 × 1/2"	95,55
B14-5	19 × 3/4"	100,50
B14-6-19	19 × 1"	133,00
B14-4-20	20 × 1/2"	95,55
B14-5-20	20 × 3/4"	145,75
B14-6-20	20 × 1"	133,00
B14-5-25	25 × 3/4"	145,75
B14-6	25 × 1"	136,25
B14-7	32 × 11/4"	183,50
B14-8	39 × 11/2"	299,00
B14-9	51 × 2"	440,50
B14-10	63 × 21/2"	599,25
B14-11	76 × 3"	793,00
B14-12	105 × 4"	1364,75

Slangenippel m. indiv. gevind

AISI 316 - BSPP



Varenr.	Ø × BSPP	DKK
B14I-1	6 × 1/8"	55,70
B14I-2	9 × 1/4"	55,70
B14I-3	11 × 3/8"	67,20
B14I-4	14 × 1/2"	81,40
B14I-5	20 × 3/4"	125,75
B14I-6	27 × 1"	171,50
B14I-7	33 × 11/4"	229,00
B14I-8	39 × 11/2"	372,75
B14I-9	50 × 2"	454,75

Slangenippel 90°

AISI 316 - BSPT

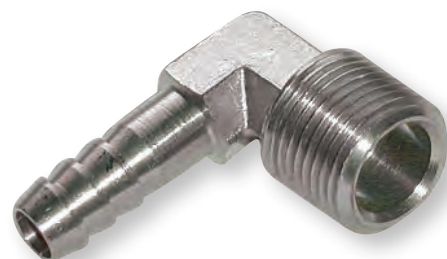

Varenr.	Ø × BSPT	DKK
B14V-2-6	6 × 1/4"	55,70
B14V-2-8	8 × 1/4"	63,90
B14V-3-10	10 × 3/8"	75,90
B14V-4-10	10 × 1/2"	109,75
B14V-4-12	12 × 1/2"	119,00
B14V-5-19	19 × 3/4"	128,50

Slangenippel af rør

AISI 316 - BSPT



Varenr.	Ø × BSPT	DKK
B14G-2	13,5 × 1/4"	39,80
B14G-3	17,2 × 3/8"	48,35
B14G-4	21,3 × 1/2"	57,60
B14G-5	26,9 × 3/4"	67,75
B14G-6	33,7 × 1"	99,35
B14G-7	42,4 × 1 1/4"	136,25
B14G-8	48,3 × 1 1/2"	163,75
B14G-9	60,3 × 2"	217,75
B14G-10	76,1 × 2 1/2"	327,25
B14G-11	88,9 × 3"	474,75
B14G-12	114,3 × 4"	682,50

Slangenippel t. svejs

AISI 316



Varenr.	Ø × dim	DKK
B14s-1	10,2 × 1/8"	39,80
B14s-2	13,5 × 1/4"	39,80
B14s-3	17,2 × 3/8"	48,35
B14s-4	21,3 × 1/2"	57,60
B14s-5	26,9 × 3/4"	67,75
B14s-6	33,7 × 1"	99,35
B14s-7	42,4 × 1 1/4"	136,25
B14s-8	48,3 × 1 1/2"	163,75
B14s-9	60,3 × 2"	217,75
B14s-10	76,1 × 2 1/2"	327,25
B14s-11	88,9 × 3"	474,75
B14s-12	114,3 × 4"	681,25

Slangeforskruing flad

AISI 316 - BSPP



Varenr.	Ø × BSPP	DKK
B46-2	6 × 1/4"	101,25
B46-3	10 × 3/8"	118,50
B46-4	13 × 1/2"	137,75
B46-5	20 × 3/4"	162,00
B46-6	25 × 1"	304,00

HUSK PAKNINGER



Slangenippel

AISI 304 - BSPP



Varenr.	Ø × BSPP	L mm	DKK
LB2-4	13,5 × 1/2"	75	50,65
LB2-5	19,7 × 3/4"	77	77,25
LB2-6	26,0 × 1"	81	103,00
LB2-7	32,3 × 1 1/4"	88	120,75
LB2-8	38,7 × 1 1/2"	98	188,50
LB2-9	51,4 × 2"	108	260,00
LB2-10	64,7 × 2 1/2"	133	400,75
LB2-11	77,5 × 3"	143	528,00
LB2-12	102,8 × 4"	168	917,50
LB2-13	128,3 × 5"	233	1827,25
LB2-14	153,6 × 6"	252	2266,00
LB2-16	204,5 × 8"	288	3898,75

Slangenippel

GALVANISERET - BSPP



Varenr.	Ø × BSPP	L mm	DKK
LG2-4	13,5 × 1/2"	75	21,45
LG2-5	19,7 × 3/4"	77	21,95
LG2-6	26,0 × 1"	81	27,15
LG2-7	32,3 × 1 1/4"	88	30,40
LG2-8	38,7 × 1 1/2"	98	38,30
LG2-9	51,4 × 2"	108	128,25
LG2-10	64,7 × 2 1/2"	133	133,25
LG2-11	77,5 × 3"	143	149,25
LG2-12	102,8 × 4"	168	223,75
LG2-13	128,3 × 5"	233	501,50
LG2-14	153,6 × 6"	252	691,50
LG2-16	204,5 × 8"	288	883,75

Slangesamler

AISI 304



Varenr.	dim	L mm	DKK
LB3-4	13,5 ~ 1/2"	79,8	105,25
LB3-5	19,7 ~ 3/4"	99,8	134,75
LB3-6	26,0 ~ 1"	99,8	202,00
LB3-7	32,3 ~ 1 1/4"	99,8	268,50
LB3-8	38,7 ~ 1 1/2"	99,8	356,00
LB3-9	51,4 ~ 2"	111	511,00
LB3-10	64,7 ~ 2 1/2"	136	926,25
LB3-11	77,5 ~ 3"	146	1189,75
LB3-12	102,8 ~ 4"	171	1998,25
LB3-13	128,3 ~ 5"	236	3485,75
LB3-14	153,6 ~ 6"	255	4465,25
LB3-16	204,5 ~ 8"	291	8631,50

Slangesamler GALVANISERET



Varenr.	dim	L mm	DKK
LG3-4	13,5 ~ 1/2"	79,8	10,15
LG3-5	19,7 ~ 3/4"	99,8	16,10
LG3-6	26,0 ~ 1"	99,8	20,45
LG3-7	32,3 ~ 1 1/4"	99,8	29,00
LG3-8	38,7 ~ 1 1/2"	99,8	35,75
LG3-9	51,4 ~ 2"	111	44,45
LG3-10	64,7 ~ 2 1/2"	136	75,65
LG3-11	77,5 ~ 3"	146	105,25
LG3-12	102,8 ~ 4"	171	190,50
LG3-13	128,3 ~ 5"	236	297,00
LG3-14	153,6 ~ 6"	255	378,00
LG3-16	204,5 ~ 8"	291	658,00

Slangesamler

AISI 304



Varenr.	Ø	DKK
BE31-1	6	18,20
BE31-2	8	20,50
BE31-3	10	22,75
BE31-4	12	25,55

Slangesamler T-stk

AISI 304



Varenr.	Ø	DKK
BE32-1	6	47,75
BE32-2	8	50,05
BE32-3	10	52,30
BE32-4	12	55,70

Slangesamler Y-stk

AISI 304



Varenr.	Ø	DKK
BE33-1	6	56,85
BE33-2	8	63,65
BE33-3	10	68,25
BE33-4	12	72,90

Slangesamler 90°

AISI 304



Varenr.	Ø	DKK
BE35-1	6	60,05
BE35-2	8	62,55
BE35-3	10	64,95
BE35-4	12	70,45

Slangesamler kryds

AISI 304



Varenr.	Ø	DKK
BE36-1	6	56,85
BE36-2	8	63,65
BE36-3	10	68,25
BE36-4	12	72,90

SLANGEFITTINGS MESSING



Max. 10 bar



-10°C til +80°C



Bredt program af slangeftittings i messing.

Tryk: max 10bar

- enkelte kan dog tage meget højere tryk. Forhør nærmere, hvis du skal bruge slangeftittings til højere tryk end 10bar.

Slangenippel MESSING - BSPT



Varenr.	Ø × BSPT	DKK	Varenr.	Ø × BSPT	DKK
744704001	4 × 1/8"	14,00	744704051	16 × 1/2"	37,25
744704018	5 × 1/8"	12,00	744704052	16 × 3/4"	42,50
744704019	5 × 1/4"	14,40	744704056	20 × 1/2"	49,75
744704020	6 × 1/8"	12,90	744704006	20 × 3/4"	56,25
744704002	6 × 1/4"	14,80	744704043	20 × 1"	68,85
744704021	6 × 3/8"	19,30	744704057	20 × 1 1/4"	100,75
744704022	6 × 1/2"	26,55	744704058	25 × 3/4"	56,00
744704024	8 × 1/8"	14,00	744704008	25 × 1"	67,20
744704025	8 × 1/4"	14,00	744704059	25 × 1 1/4"	104,25
744704027	8 × 3/8"	16,00	744704060	25 × 1 1/2"	119,75
744704028	8 × 1/2"	26,55	744704061	32 × 1"	86,55
744704030	10 × 1/8"	16,00	744704062	32 × 1 1/4"	121,50
744704031	10 × 1/4"	14,00	744704063	32 × 1 1/2"	133,00
744704003	10 × 3/8"	16,00	744704064	38 × 1"	110,00
744704033	10 × 1/2"	27,25	744704065	38 × 1 1/4"	117,00
744704038	12 × 1/4"	18,00	744704066	38 × 1 1/2"	132,75
744704039	12 × 3/8"	16,00	744704068	52 × 1 1/2"	182,00
744704040	12 × 1/2"	22,60	744704069	52 × 2"	267,25
744704041	12 × 3/4"	41,50	744704070	62 × 2"	358,00
744704049	16 × 1/4"	22,60	744704071	62 × 2 1/2"	562,25
744704050	16 × 3/8"	24,25	744704114	80 × 3"	564,75
			744704115	100 × 4"	628,25

Slangenippel forniklet MESSING - BSPT



Varenr.	Ø × BSPT	bar	DKK
E13K-1	6 × 1/8"	150	12,90
E13K-2	6 × 1/4"	100	14,80
E13K-3	7 × 1/8"	150	12,90
E13K-4	7 × 1/4"	100	14,00
E13K-5	8 × 1/8"	150	14,00
E13K-6	8 × 1/4"	100	14,00
E13K-7	9 × 1/8"	150	14,00
E13K-8	9 × 1/4"	100	14,00
E13K-9	9 × 3/8"	75	16,00
E13K-10	9 × 1/2"	50	16,00
E13K-11	10 × 1/8"	150	16,00
E13K-12	10 × 1/4"	100	14,00
E13K-13	10 × 3/8"	75	16,00
E13K-14	10 × 1/2"	50	27,20
E13K-15	12 × 1/4"	100	17,95
E13K-16	12 × 3/8"	75	16,00
E13K-17	12 × 1/2"	50	22,55
E13K-18	14 × 3/8"	75	33,30
E13K-19	14 × 1/2"	50	33,30
E13K-20	16 × 1/4"	100	20,60
E13K-21	16 × 3/8"	75	22,55
E13K-22	16 × 1/2"	50	22,55
E13K-22-1	16 × 3/4"	85	37,25
E13K-24	17 × 3/8"	75	22,55
E13K-24-1	17 × 1/2"	50	22,55
E13K-26	18 × 3/8"	75	22,55
E13K-25	18 × 1/2"	50	22,55
E13K-27	18 × 3/4"	85	37,25
E13K-28	20 × 3/8"	75	42,40
E13K-29	20 × 1/2"	50	42,40
E13K-30	20 × 3/4"	85	42,40
E13K-31	25 × 3/4"	85	50,85
E13K-32	25 × 1"	80	80,55

Slangenippel m. kort gevind

MESSING - BSPP



Varenr.	Ø × BSPP	DKK
ET13-1	6 × 1/4"	11,75
ET13-2	8 × 1/4"	15,45
ET13-3	10 × 1/4"	18,25
ET13-4	10 × 3/8"	13,65
ET13-5	12 × 3/8"	17,65
ET13-6	12 × 1/2"	19,30
ET13-7	14 × 3/8"	15,30
ET13-8	14 × 1/2"	20,60
ET13-9	15 × 1/2"	30,15
ET13-10	20 × 1/2"	23,25
ET13-11	20 × 3/4"	36,15
ET13-12	25 × 3/4"	50,60
ET13-13	25 × 1"	51,80
ET13-14	30 × 1"	59,25
ET13-15	35 × 1 1/4"	70,45
ET13-16	40 × 1 1/2"	102,50
ET13-17	45 × 1 1/2"	158,00
ET13-18	50 × 2"	149,75

Slangenippel fornicket

MESSING - BSPP



Varenr.	Ø × BSPP	bar	DKK
E13-0	4,5 × M5		10,60
E13-1	7 × 1/8"	150	9,35
E13-4	7 × 1/4"	100	10,60
E13-2	8 × 1/8"	150	9,35
E13-5	8 × 1/4"	100	10,60
E13-3	9 × 1/8"	150	9,35
E13-6	9 × 1/4"	100	10,60
E13-8	9 × 3/8"	75	16,20
E13-7	12 × 1/4"	100	10,60
E13-9	12 × 3/8"	75	16,20
E13-11	12 × 1/2"	50	26,00
E13-10	17 × 3/8"	75	16,20
E13-12	17 × 1/2"	50	26,00

Slangenippel fornicket

MESSING / NBR - BSPP



Varenr.	Ø × BSPP	bar	DKK
E13R-0	4,5 × M5		9,35
E13R-1	7 × 1/8"	150	9,30
E13R-2	7 × 1/4"	100	12,10
E13R-3	8 × 1/8"	150	9,70
E13R-4	8 × 1/4"	100	13,35
E13R-5	9 × 1/8"	150	11,15
E13R-6	9 × 1/4"	100	12,40
E13R-7	9 × 3/8"	75	16,20
E13R-8	12 × 1/4"	100	13,65
E13R-9	12 × 3/8"	75	16,20
E13R-10	12 × 1/2"	50	25,60
E13R-11	17 × 3/8"	75	19,05
E13R-12	17 × 1/2"	50	26,30

Slangenippel

BRONZE - BSPP



Varenr.	Ø × BSPP	DKK
EZ9-3-10	10 × 3/8"	52,60
EZ9-4-12	12 × 1/2"	82,50
EZ9-3-13	13 × 3/8"	53,45
EZ9-4-14	14 × 1/2"	84,90
EZ9-4-16	16 × 1/2"	84,10
EZ9-5-16	16 × 3/4"	104,00
EZ9-4-19	19 × 1/2"	88,45
EZ9-5-19	19 × 3/4"	102,75
EZ9-4-20	20 × 1/2"	89,00
EZ9-5-20	20 × 3/4"	103,50
EZ9-5-25	25 × 3/4"	105,00
EZ9-6-25	25 × 1"	169,25
EZ9-6-30	30 × 1"	160,75
EZ9-7-30	30 × 1 1/4"	288,50
EZ9-6-32	32 × 1"	168,25
EZ9-7-32	32 × 1 1/4"	292,25
EZ9-7-35	35 × 1 1/4"	278,00
EZ9-7-38	38 × 1 1/4"	291,00
EZ9-8-38	38 × 1 1/2"	374,25
EZ9-7-40	40 × 1 1/4"	292,25
EZ9-8-40	40 × 1 1/2"	378,00
EZ9-8-45	45 × 1 1/2"	353,00
EZ9-8-50	50 × 1 1/2"	369,00
EZ9-9-50	50 × 2"	586,25
EZ9-9-60	60 × 2"	533,00

Slangenippel m. indiv. gevind

MESSING - BSPT



Varenr.	Ø × BSPT	DKK
744712020	6 × 1/8"	19,95
744712002	6 × 1/4"	22,20
744712021	6 × 3/8"	32,10
744712022	6 × 1/2"	36,70
744712024	8 × 1/8"	19,95
744712025	8 × 1/4"	22,20
744712027	8 × 3/8"	32,10
744712028	8 × 1/2"	36,70
744712030	10 × 1/8"	19,95
744712031	10 × 1/4"	22,20
744712003	10 × 3/8"	32,10
744712033	10 × 1/2"	36,70
744712038	13 × 1/4"	21,25
744712042	13 × 3/8"	24,60
744712043	13 × 1/2"	33,30

Slangenippel m. indiv.gev.

MESSING - BSPP



Varenr.	Ø × BSPP	DKK
ET14-3	10 × 1/4"	13,00
ET14-4	10 × 3/8"	18,50
ET14-4-1	10 × 1/2"	26,25
ET14-4-2	13 × 1/2"	26,00
ET14-9	15 × 1/2"	26,00
ET14-9-1	18 × 1/2"	27,20
ET14-11	20 × 3/4"	42,40
ET14-13	25 × 1"	49,40
ET14-14	30 × 1"	59,25
ET14-14-1	30 × 1 1/4"	113,50
ET14-15	35 × 1 1/4"	116,00

Slangenippel m. indiv. gevind

MESSING - BSPP

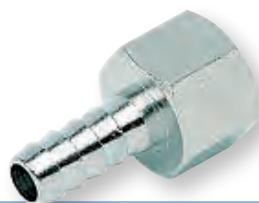

Varenr.	Ø × BSPP	bar	DKK
E13F-1	6 × 1/8"	150	12,20
E13F-2	7 × 1/8"	150	12,20
E13F-4	7 × 1/4"	100	13,00
E13F-5	8 × 1/4"	100	14,00
E13F-6	9 × 1/4"	100	14,00
E13F-7	9 × 3/8"	75	17,40
E13F-8	10 × 3/8"	75	17,40
E13F-9	12 × 3/8"	75	17,40
E13F-10	12 × 1/2"	50	25,55

Slangenippel 90°

MESSING - BSPT

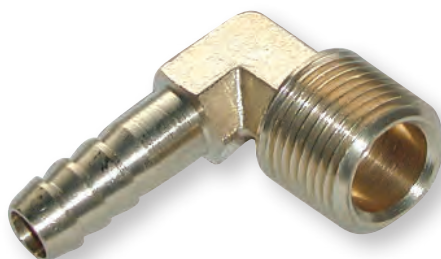

Varenr.	Ø × BSPT	DKK
E34-0	6 × 1/8"	17,65
E34-1	6 × 1/4"	26,00
E34-1-1	6 × 3/8"	9,75
E34-5	8 × 1/8"	23,85
E34-6	8 × 1/4"	26,00
E34-7	8 × 3/8"	29,30
E34-12	10 × 1/4"	29,30
E34-13	10 × 3/8"	29,30
E34-14	10 × 1/2"	54,00
E34-18	12 × 1/4"	33,30
E34-19	12 × 3/8"	30,15
E34-20	12 × 1/2"	54,00
E34-29	19 × 3/4"	123,50
E34-30	20 × 1"	116,50
E34-31	25 × 3/4"	149,75
E34-32	25 × 1"	149,75
E34-32-1	32 × 1"	161,75

Slangenippel 90°

MESSING - BSPT

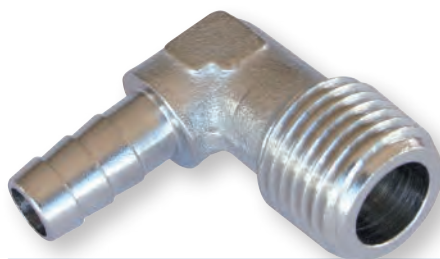

Varenr.	Ø × BSPT	bar	DKK
E13V-1	6 × 1/8"	150	19,05
E13V-2	6 × 1/4"	100	19,70
E13V-4	7 × 1/8"	150	19,05
E13V-5	7 × 1/4"	100	19,70
E13V-6	9 × 1/4"	100	22,15

Slangesamler

MESSING



Varenr.	Ø	DKK
E31-1	6	25,15
E31-2	8	28,40
E31-3	10	31,30
E31-4	12	33,55
E31-5	16	40,95
E31-6	19	42,40
E31-7	22	67,75

Slangesamler T-stk

MESSING



Varenr.	Ø	DKK
E32-0	4	24,60
E32-1	6	24,60
E32-2	8	26,00
E32-3	10	27,20
E32-4	12	38,95
E32-5	16	56,85
E32-6	19	133,00

Slangesamler Y-stk

MESSING



Varenr.	Ø	DKK
E33-1	6	24,60
E33-2	8	24,85
E33-3	10	26,25
E33-4	12	37,50
E33-5	16	55,70

Mini slangenippel

MESSING - MM



Varenr.	Ø × dim	DKK
E35-0	2 × M5	8,40
E35-1	3 × M5	9,10
E35-2	4 × M5	9,10
E35-3	6 × M5	9,85

Mini slangesamler

MESSING



Varenr.	Ø	DKK
E35-10	2	11,20
E35-11	3 × 2	11,20
E35-12	3	11,20
E35-13	4 × 3	12,45
E35-14	4	12,45
E35-15	6 × 4	12,45
E35-16	6	12,45

Mini slangesamler 90°

MESSING



Varenr.	Ø	DKK
E35-20	2	21,25
E35-21	3	21,25
E35-22	4	21,25
E35-23	6	21,25

Mini slangesamler T-stk

MESSING



Varenr.	Ø	DKK
E35-30	2	26,00
E35-31	3	26,00
E35-32	4	28,20
E35-33	6	28,20

Slangeforskrunding kon

MESSING - BSPP



Varenr.	Ø × BSPP	DKK
744711000	3 × 1/8"	12,15
744711018	5 × 1/8"	13,65
744711020	6 × 1/8"	14,00
744711002	6 × 1/4"	12,15
744711021	6 × 3/8"	16,25
744711025	8 × 1/4"	14,00
744711027	8 × 3/8"	14,00
744711031	10 × 1/4"	17,25
744711003	10 × 3/8"	15,30
744711033	10 × 1/2"	27,60
744711039	12 × 3/8"	18,50
744711040	12 × 1/2"	27,60
744711041	12 × 3/4"	38,35
744711051	16 × 1/2"	30,15
744711052	16 × 3/4"	30,15
744711054	19 × 3/4"	40,40
744711055	19 × 1"	93,90
744711008	25 × 1"	93,90

Slangeforskrunding flad

MESSING - BSPP



Varenr.	Ø × BSPP	DKK
744700017	4 × 1/4"	20,80
744700020	6 × 1/8"	15,30
744700002	6 × 1/4"	22,20
744700025	8 × 1/4"	22,20
744700027	8 × 3/8"	14,00
744700028	8 × 1/2"	17,95
744700031	10 × 1/4"	22,20
744700003	10 × 3/8"	14,00
744700033	10 × 1/2"	17,95
744700034	10 × 3/4"	26,55
744700042	13 × 3/8"	15,60
744700043	13 × 1/2"	18,50
744700044	13 × 3/4"	26,55
744700051	16 × 1/2"	36,15
744700052	16 × 3/4"	39,80
744700054	19 × 3/4"	39,80
744700055	19 × 1"	51,40
744700008	25 × 1"	41,20
744700010	32 × 1 1/4"	100,50
744700056	40 × 1 1/2"	152,75
744700059	50 × 2"	240,00
744700062	62 × 2 1/2"	579,25

Slangeforskrunding 90° kon

MESSING - BSPP



Varenr.	Ø × BSPP	DKK
744707002	6 × 1/4"	22,20
744707025	8 × 1/4"	23,25 α
744707027	8 × 3/8"	45,20
744707003	10 × 3/8"	45,20
744707033	10 × 1/2"	58,45
744707043	13 × 1/2"	58,45
744707054	19 × 3/4"	72,10
744707008	25 × 1"	148,75

α = lavet af stål

Slangeforskrunding 90° flad

MESSING - BSPP



Varenr.	Ø × BSPP	DKK
744705025	8 × 1/4"	34,70
744705027	8 × 3/8"	45,70
744705028	8 × 1/2"	51,40
744705003	10 × 3/8"	31,30
744705033	10 × 1/2"	54,30
744705034	10 × 3/4"	102,25
744705043	13 × 1/2"	59,50
744705044	13 × 3/4"	100,50
744705051	16 × 1/2"	59,50
744705052	16 × 3/4"	94,75
744705054	19 × 3/4"	94,75
744705008	25 × 1"	148,75

HUSK PAKNINGER



Brystnippel

MESSING - BSPP



60° konus i den ene ende

Varenr.	BSPP	DKK
E282-2	1/4"	11,75
E282-3	3/8"	12,30
E282-4	1/2"	27,70
E282-5	3/4"	44,00
E282-6	1"	77,55

Slangenippel m. muffe til gas

MESSING - BSPP



Varenr.	Ø × BSPP	Gas type	DKK
E38-1	10 × 3/8"	LPG	38,10
E38-2	10 × 1/2"	LPG	49,40
E38-10	15 × 3/8"	NG	46,95
E38-11	15 × 1/2"	NG	56,50

NG = naturgas - LPG = flaskegas

Kobling skotgennemføring

MESSING - BSPP



Varenr.	BSPP	Ext. dim	DKK
ET3-1	3/8"	18	67,75
ET3-2	1/2"	22	73,15
ET3-3	3/4"	27	97,20
ET3-4	1"	34	133,25
ET3-5	1 1/4"	43	217,00
ET3-6	1 1/2"	49	260,00
ET3-7	2"	61	405,75

Brystnippel

MESSING - BSPP × BSPT



60° konus i BSPP enden

Varenr.	BSPP × BSPT	DKK
E283-2	1/4"	12,30
E283-3	3/8"	12,30
E283-4	1/2"	27,70
E283-5	3/4"	44,00
E283-6	1"	77,55

Kobling nippel/studs

MESSING - BSPT



Varenr.	Ø × BSPT	DKK
ET1-1	15 × 1/2"	75,65
ET1-2	20 × 3/4"	125,75
ET1-3	25 × 1"	156,25
ET1-4	30 × 1"	178,00
ET1-5	30 × 1 1/4"	188,50
ET1-6	35 × 1 1/4"	242,75
ET1-7	40 × 1 1/2"	269,50
ET1-8	50 × 2"	431,75
ET1-9	60 × 2"	864,50
ET1-10	60 × 2 1/2"	908,50

Kobling 90° nip/studs

MESSING - BSPT



Varenr.	Ø × BSPP	DKK
ET4-1	15 × 1/2"	102,00
ET4-2	20 × 3/4"	141,75
ET4-3	25 × 1"	186,50
ET4-4	30 × 1"	218,25
ET4-5	30 × 1 1/4"	229,50
ET4-6	35 × 1 1/4"	292,75
ET4-7	40 × 1 1/2"	343,00
ET4-8	50 × 2"	542,50
ET4-9	60 × 2"	1064,00
ET4-10	60 × 2 1/2"	1108,50

Slangenippel til gas

MESSING - BSPT



Varenr.	Ø × BSPT	Gas type	DKK
E37-1	10 × 3/8"	LPG	38,10
E37-2	10 × 1/2"	LPG	49,40
E37-10	15 × 3/8"	NG	46,95
E37-11	15 × 1/2"	NG	56,50

NG = naturgas - LPG = flaskegas

Kobling studs/studs

MESSING



Varenr.	Ø	DKK
ET2-1	13	59,00
ET2-2	15	72,10
ET2-3	18	73,70
ET2-4	20	117,75
ET2-5	25	158,50
ET2-6	30	178,00
ET2-7	35	207,00
ET2-8	40	272,75
ET2-9	45	354,75
ET2-10	50	413,50

Afløb m. slutmuffe

MESSING - BSPP



Varenr.	BSPP	Ext. dim	DKK
ET5-1	1/2"	22	89,00
ET5-2	3/4"	27	125,75
ET5-3	1"	34	136,00
ET5-4	1 1/4"	43	248,25

SLANGEFITTINGS GALVANISERET



Slangenippel GALVANISERET - BSPP



Varenr.	Ø × BSPP	L mm	DKK
LG2-4	13,5 × 1/2"	75	21,45
LG2-5	19,7 × 3/4"	77	21,95
LG2-6	26,0 × 1"	81	27,15
LG2-7	32,3 × 1 1/4"	88	30,40
LG2-8	38,7 × 1 1/2"	98	38,30
LG2-9	51,4 × 2"	108	128,25
LG2-10	64,7 × 2 1/2"	133	133,25
LG2-11	77,5 × 3"	143	149,25
LG2-12	102,8 × 4"	168	223,75
LG2-13	128,3 × 5"	233	501,50
LG2-14	153,6 × 6"	252	691,50
LG2-16	204,5 × 8"	288	883,75

Slangesamler GALVANISERET



Varenr.	dim	L mm	DKK
LG3-4	13,5 ~ 1/2"	79,8	10,15
LG3-5	19,7 ~ 3/4"	99,8	16,10
LG3-6	26,0 ~ 1"	99,8	20,45
LG3-7	32,3 ~ 1 1/4"	99,8	29,00
LG3-8	38,7 ~ 1 1/2"	99,8	35,75
LG3-9	51,4 ~ 2"	111	44,45
LG3-10	64,7 ~ 2 1/2"	136	75,65
LG3-11	77,5 ~ 3"	146	105,25
LG3-12	102,8 ~ 4"	171	190,50
LG3-13	128,3 ~ 5"	236	297,00
LG3-14	153,6 ~ 6"	255	378,00
LG3-16	204,5 ~ 8"	291	658,00

SLANGEFITTINGS NYLON



Max 14bar ved 20°C



-20°C til +90°C



Bredt program af slangefitTINGS i nylon.

Slangenippel

PA (POLYAMID) - BSPT



Varenr.	Ø × BSPT	DKK
A1-1	4 × 1/8"	6,55
A1-2	4 × 1/4"	7,30
A1-3	5 × 1/8"	6,55
A1-4	5 × 1/4"	7,30
A1-5	6 × 1/8"	7,30
A1-6	6 × 1/4"	8,10
A1-7	6 × 3/8"	8,10
A1-8	6 × 1/2"	8,90
A1-8-5	6 × 3/4"	8,05
A1-9	8 × 1/8"	8,10
A1-10	8 × 1/4"	8,90
A1-11	8 × 3/8"	8,90
A1-12	8 × 1/2"	9,75
A1-12-5	8 × 3/4"	11,90
A1-13	10 × 1/4"	9,75
A1-14	10 × 3/8"	10,55
A1-15	10 × 1/2"	10,55

A1-17	10 × 3/4"	11,40
A1-18	12 × 1/4"	10,55
A1-20	12 × 3/8"	10,55
A1-21	12 × 1/2"	11,40
A1-22	12 × 3/4"	12,20
A1-23	14 × 3/8"	10,55
A1-24	14 × 1/2"	11,40
A1-25	14 × 3/4"	12,20
A1-26	16 × 1/2"	12,20
A1-27	16 × 3/4"	12,90
A1-28	19 × 1/2"	12,90
A1-29	19 × 3/4"	13,70
A1-30	19 × 1"	17,05
A1-31	25 × 3/4"	22,20
A1-32	25 × 1"	24,45

α = spørg på pris

Slangenippel m. indiv. gevind

PA (POLYAMID) - BSPP



Varenr.	Ø × BSPP	DKK
A1F-1	5 × 1/8"	8,05
A1F-2	5 × 1/4"	6,95
A1F-3	5 × 3/8"	7,70
A1F-4	5 × 1/2"	8,65
A1F-5	6 × 1/8"	8,30
A1F-6	6 × 1/4"	9,40
A1F-7	6 × 3/8"	9,40
A1F-8	6 × 1/2"	10,25
A1F-9	8 × 1/8"	9,60
A1F-10	8 × 1/4"	10,25
A1F-11	8 × 3/8"	10,25
A1F-12	8 × 1/2"	10,85
A1F-13	10 × 1/4"	11,20
A1F-14	10 × 3/8"	11,80
A1F-15	10 × 1/2"	11,95
A1F-16	12 × 1/4"	11,20
A1F-17	12 × 3/8"	11,95
A1F-18	12 × 1/2"	12,20
A1F-19	14 × 3/8"	11,60
A1F-20	14 × 1/2"	12,20
A1F-21	16 × 1/2"	14,75
A1F-22	19 × 1/2"	15,05

Slangenippel 90° PA (POLYAMID) - BSPT



Varenr.	Ø × BSPT	DKK
A2-1	4 × 1/8"	8,10
A2-2	4 × 1/4"	8,90
A2-3	5 × 1/8"	8,10
A2-4	5 × 1/4"	8,90
A2-4-1	5 × 1/2"	9,45
A2-5	6 × 1/8"	8,10
A2-6	6 × 1/4"	8,90
A2-7	6 × 3/8"	9,75
A2-8	6 × 1/2"	9,75
A2-9	8 × 1/8"	9,75
A2-10	8 × 1/4"	10,55
A2-11	8 × 3/8"	10,55
A2-12	8 × 1/2"	10,55
A2-13	10 × 1/4"	10,55
A2-14	10 × 3/8"	10,55
A2-15	10 × 1/2"	12,20
A2-17	10 × 3/4"	12,90
A2-18	12 × 1/4"	12,20
A2-20	12 × 3/8"	12,20
A2-21	12 × 1/2"	12,90
A2-22	12 × 3/4"	12,90
A2-23	14 × 3/8"	12,90
A2-24	14 × 1/2"	13,70
A2-25	14 × 3/4"	13,70
A2-26	16 × 1/2"	16,05
A2-27	16 × 3/4"	16,05
A2-28	19 × 1/2"	16,05
A2-29	19 × 3/4"	16,90

Slangenippel 90° PA (POLYAMID) - BSPP



Varenr.	Ø × BSPP	DKK
A2C-14	10 × 3/8"	15,70

Slangenippel T-stk PA (POLYAMID) - BSPT



Varenr.	Ø × BSPT × Ø	DKK
A10-1	4 × 1/8" × 4	7,30
A10-2	4 × 1/4" × 4	8,05
A10-3	5 × 1/8" × 5	6,55
A10-4	5 × 1/4" × 5	8,05
A10-5	6 × 1/8" × 6	8,05
A10-6	6 × 1/4" × 6	8,90
A10-7	6 × 3/8" × 6	10,55
A10-8	6 × 1/2" × 6	10,55
A10-9	8 × 1/8" × 8	10,55
A10-10	8 × 1/4" × 8	11,20
A10-11	8 × 3/8" × 8	12,20
A10-12	8 × 1/2" × 8	12,20
A10-13	10 × 1/4" × 10	12,20
A10-14	10 × 3/8" × 10	12,90
A10-15	10 × 1/2" × 10	12,90
A10-17	10 × 3/4" × 10	13,70
A10-18	12 × 1/4" × 12	12,20
A10-20	12 × 3/8" × 12	12,90
A10-21	12 × 1/2" × 12	12,90
A10-22	12 × 3/4" × 12	13,70
A10-23	14 × 3/8" × 14	12,90
A10-24	14 × 1/2" × 14	13,70
A10-25	14 × 3/4" × 14	14,50
A10-26	16 × 1/2" × 16	16,05
A10-27	16 × 3/4" × 16	16,90
A10-28	19 × 1/2" × 19	16,90
A10-29	19 × 3/4" × 19	17,90

Slangenippel T-stk PA (POLYAMID) - BSPP



Varenr.	Ø × BSPP × Ø	DKK
A10C-14	10 × 3/8" × 10	23,00
A10C-15	10 × 1/2" × 10	23,00

Slangeforskruing konus PA (POLYAMID) - BSPP



Varenr.	Ø × BSPP	DKK
A12-1	4 × 1/8"	16,05
A12-3	4 × 1/4"	16,90
A12-2	5 × 1/8"	16,05
A12-4	5 × 1/4"	16,90
A12-7	5 × 3/8"	20,30
A12-5	6 × 1/4"	16,90
A12-8	6 × 3/8"	20,30
A12-11	6 × 1/2"	20,90
A12-6	8 × 1/4"	17,90
A12-9	8 × 3/8"	20,90
A12-12	8 × 1/2"	21,85
A12-16	8 × 3/4"	23,35
A12-10	10 × 3/8"	20,90
A12-13	10 × 1/2"	21,85
A12-17	10 × 3/4"	23,35
A12-14	12 × 1/2"	21,60
A12-18	12 × 3/4"	24,85
A12-15	14 × 1/2"	21,85
A12-19	14 × 3/4"	25,85
A12-20	16 × 3/4"	26,45
A12-21	19 × 3/4"	26,45

Slangesamler PA (POLYAMID)



Varenr.	Ø	DKK
A6-1	4	6,55
A6-2	5	6,55
A6-3	6	6,55
A6-4	8	7,30
A6-5	10	7,30
A6-6	12	8,05
A6-7	14	8,05
A6-8	16	8,90
A6-9	19	9,75

Slangesamler reduktion

PA (POLYAMID)



Varenr.	Ø	DKK
A5-1	5 × 4	5,70
A5-2	6 × 4	6,55
A5-3	6 × 5	6,55
A5-4	8 × 5	7,30
A5-5	8 × 6	7,30
A5-6	10 × 6	7,30
A5-7	10 × 8	8,05
A5-8	12 × 8	8,05
A5-9	12 × 10	8,90
A5-10	14 × 10	8,90
A5-11	14 × 12	9,75
A5-12	16 × 12	9,75
A5-13	16 × 14	9,75
A5-14	19 × 14	10,55
A5-15	19 × 16	10,55

Slangesamler 90°

PA (POLYAMID)



Varenr.	Ø	DKK
A4-1	4	6,55
A4-2	5	7,30
A4-3	6	8,10
A4-4	8	8,90
A4-5	10	10,55
A4-6	12	11,40
A4-7	14	12,20
A4-8	16	12,90
A4-9	19	14,50

Slangesamler 90° red.

PA (POLYAMID)



Varenr.	Ø	DKK
A3-1	5 × 4	7,30
A3-2	6 × 5	8,10
A3-3	8 × 6	8,90
A3-3-1	10 × 6	8,90
A3-4	10 × 8	9,75
A3-5	12 × 10	10,55
A3-6	14 × 12	11,20
A3-7	16 × 14	12,20
A3-8	19 × 16	12,90

Slangesamler T-stk

PA (POLYAMID)



Varenr.	Ø	DKK
A9-1	4	7,30
A9-2	5	8,05
A9-3	6	8,90
A9-4	8	10,25
A9-5	10	11,20
A9-6	12	12,20
A9-7	14	13,70
A9-8	16	16,05
A9-9	19	16,90

Slangesamler T-stk red.

PA (POLYAMID)



Varenr.	Ø	DKK
A8-1	5 × 4 × 5	8,05
A8-2	6 × 5 × 6	8,90
A8-3	8 × 6 × 8	10,25
A8-4	10 × 8 × 10	11,20
A8-5	12 × 10 × 12	12,20
A8-6	14 × 12 × 14	12,90
A8-7	16 × 14 × 16	16,90
A8-8	19 × 16 × 19	17,90

Slangesamler Y-stk

PA (POLYAMID)



Varenr.	Ø	DKK
A7-1	4	7,05
A7-2	6	8,65
A7-3	8	10,15
A7-4	10	12,90
A7-6	17	16,60

Slangesamler Y-stk

PA (POLYAMID)



Varenr.	Ø	DKK
A7-2-1	7	5,85 ₺

₺ = så længe lager haves

Slangesamler kryds

PA (POLYAMID)



Varenr.	Ø	DKK
A50-4	8	15,40 ₺
A50-5	10	17,30 ₺

₺ = så længe lager haves

Slangenippel 90° svivel

PA (POLYAMID) / EPDM - BSPP



Varenr.	Ø × BSPP	DKK
AS2-5	16 × 1/2"	23,15 ₺
AS2-6	16 × 3/4"	23,15 ₺

₺ = så længe lager haves

Slangenippel T-stk svivel

PA (POLYAMID) / EPDM - BSPP



Varenr.	Ø × BSPP × Ø	DKK
AS10-1	8 × 3/8" × 8	21,35 ₺
AS10-2	8 × 1/2" × 8	22,30 ₺
AS10-3	10 × 3/8" × 10	22,30 ₺
AS10-4	10 × 1/2" × 10	23,55 ₺
AS10-5	16 × 1/2" × 16	24,40 ₺
AS10-6	16 × 3/4" × 16	24,40 ₺

₺ = så længe lager haves

Slangenippel 90° svivel

PA (POLYAMID) - BSPP



Varenr.	Ø × BSPP	DKK
AS106-1	8 × 1/4"	20,30 ₺
AS106-3	8 × 1/2"	20,95 ₺
AS106-4	8 × 3/4"	24,40 ₺
AS106-5	10 × 1/4"	20,95 ₺
AS106-6	10 × 3/8"	21,35 ₺
AS106-7	10 × 1/2"	21,35 ₺
AS106-8	10 × 3/4"	24,40 ₺
AS106-9	16 × 1/2"	24,40 ₺
AS106-10	16 × 3/4"	24,40 ₺
AS106-11	19 × 1/2"	29,95 ₺
AS106-12	19 × 3/4"	29,95 ₺

₺ = så længe lager haves

Slangenippel T-stk svivel

PA (POLYAMID) - BSPP



Varenr.	Ø × BSPP × Ø	DKK
AS9-1	8 × 1/4" × 8	20,95 ₺
AS9-2	8 × 3/8" × 8	22,30 ₺
AS9-3	8 × 1/2" × 8	22,30 ₺
AS9-4	8 × 3/4" × 8	24,40 ₺
AS9-5	10 × 1/4" × 10	24,40 ₺
AS9-6	10 × 3/8" × 10	23,55 ₺
AS9-7	10 × 1/2" × 10	23,55 ₺
AS9-8	10 × 3/4" × 10	27,15 ₺
AS9-9	16 × 1/2" × 16	27,15 ₺
AS9-10	16 × 3/4" × 16	28,50 ₺

₺ = så længe lager haves



541

SLANGEFITTINGS PVDF



Max 18bar



Fittings: -63°C til +130°C



Bredt program af slangefittings i PVDF med unikke muligheder. PVDF fittings kan bruges til næsten alle kemikalier og opløsningsmidler, samtidig med at de har lav friktion og et meget bredt temperaturområde. Virker også elektrisk isolerende samt har god vejrbestandighed. Dette gør PVDF slangefittings unik til et utal af forskellige installationer.

Slangenippel

PVDF (POLYVINYLIDENFLUORID) - BSPT



Varenr.	Ø × BSPT	DKK
A1-1T	4 × 1/8"	49,40
A1-2T	4 × 1/4"	52,85
A1-4T	5 × 1/4"	52,85
A1-5T	6 × 1/8"	52,85
A1-6T	6 × 1/4"	63,65
A1-7T	6 × 3/8"	67,20
A1-10T	8 × 1/4"	70,45
A1-11T	8 × 3/8"	74,00
A1-13T	10 × 1/4"	74,00
A1-14T	10 × 3/8"	77,85
A1-23T	14 × 3/8"	81,10

Slangenippel T-stk

PVDF (POLYVINYLIDENFLUORID) - BSPT



Varenr.	Ø × BSPT × Ø	DKK
A10-1T	4 × 1/8" × 4	63,65
A10-2T	6 × 1/8" × 6	67,20
A10-3T	10 × 1/8" × 10	67,20
A10-4T	4 × 1/4" × 4	67,20
A10-5T	5 × 1/4" × 5	67,20
A10-6T	6 × 1/4" × 6	70,45
A10-7T	8 × 1/4" × 8	81,10
A10-8T	10 × 1/4" × 10	87,95
A10-9T	12 × 1/4" × 12	91,75
A10-10T	6 × 3/8" × 6	74,00
A10-11T	8 × 3/8" × 8	87,95
A10-12T	10 × 3/8" × 10	91,75
A10-13T	12 × 3/8" × 12	91,75

Slangesamler reduktion

PVDF (POLYVINYLIDENFLUORID)



Varenr.	Ø	DKK
A5-1T	6 × 4	49,40
A5-2T	6 × 5	52,85
A5-3T	8 × 6	63,65
A5-4T	10 × 6	63,65
A5-5T	10 × 8	67,20
A5-6T	12 × 6	74,00
A5-7T	12 × 8	74,00
A5-8T	12 × 10	75,65

Slangenippel 90°

PVDF (POLYVINYLIDENFLUORID) - BSPT



Varenr.	Ø × BSPT	DKK
A2-1T	4 × 1/8"	67,20
A2-2T	4 × 1/4"	70,45
A2-4T	5 × 1/4"	70,45
A2-5T	6 × 1/8"	67,20
A2-6T	6 × 1/4"	77,85
A2-7T	6 × 3/8"	74,00
A2-10T	8 × 1/4"	77,85
A2-11T	8 × 3/8"	81,10
A2-13T	10 × 1/4"	81,10
A2-14T	10 × 3/8"	87,95
A2-23T	14 × 3/8"	98,55

Slangesamler

PVDF (POLYVINYLIDENFLUORID)



Varenr.	Ø	DKK
A6-1T	4	45,70
A6-2T	5	49,40
A6-3T	6	52,85
A6-4T	8	52,85
A6-5T	10	63,65
A6-6T	12	67,20

Slangesamler 90°

PVDF (POLYVINYLIDENFLUORID)



Varenr.	Ø	DKK
A4-1T	4	52,85
A4-2T	5	63,65
A4-3T	6	67,20
A4-4T	8	70,45
A4-5T	10	77,85
A4-6T	12	81,10

Slangesamler T-stk

PVDF (POLYVINYLIDENFLUORID)



Varenr.	Ø	DKK
A9-1T	4	63,65
A9-2T	5	67,20
A9-3T	6	70,45
A9-4T	8	77,85
A9-5T	10	81,10
A9-6T	12	87,95
A9-9T	19	96,65

Slangesamler T-stk red.

PVDF (POLYVINYLIDENFLUORID)



Varenr.	Ø	DKK
A8-1T	10 × 4 × 10	74,30
A8-2T	12 × 10 × 12	100,50

Slangesamler Y-stk

PVDF (POLYVINYLIDENFLUORID)



Varenr.	Ø	DKK
A7-1T	5	71,80
A7-2T	6	74,00
A7-3T	10	102,50
A7-4T	12	113,50

Teflonslange 50m

PTFE (TEFLON)

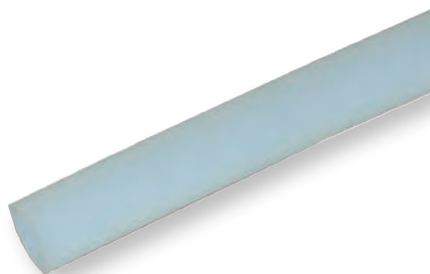

Lav friktion, egnet til næsten alle kemikalier og opløsningsmidler. Elektrisk isolerende og vejrbestandig, ideel til rustfri push-in og kompres.fittings.

-150° til +210°C

Varenr.	Ø/ø	BAR	L	DKK / m
J50000402	4/2	95	50m	87,35
J50000604	6/4	80	50m	95,90
J50000806	8/6	56	50m	122,25
J50001008	10/8	42	50m	152,75
J50001210	12/10	34	50m	216,75

Afskæres mellem 1 - 5m, ellers 50m.



62

SLANGEFITTINGS NYLON NATURAL



Max 10bar ved 20°C



-20°C til +90°C



Program af slangeittings i nylon.

SLANGEFITTINGS & SLANGER

Slangenippel

PA (POLYAMID) - BSPT



Varenr.	Ø × BSPT	DKK
AN14L-3	10 × 3/8"	4,70 α
AN14L-7	12 × 3/4"	6,10 α
AN14L-8	13 × 1/2"	5,55 α
AN14L-10	16 × 3/8"	6,30 α
AN14L-14	20 × 3/4"	7,25 α
AN14L-15	20 × 1"	8,75 α
AN14L-16	22 × 1"	8,35 α
AN14L-19	25 × 1 1/4"	12,80 α
AN14L-22	32 × 1"	10,75 α
AN14L-26	40 × 1 1/4"	18,20 α

α = så længe lager haves

Slangeforskruing 90° flad

PA (POLYAMID) - BSPP



Varenr.	Ø × BSPP	DKK
AN14B-1	12 × 1/2"	15,30 α
AN14B-5	22 × 1"	20,65 α
AN14B-6	25 × 1"	20,65 α
AN14B-7	25 × 1 1/4"	9,00 α
AN14B-8	30 × 1 1/4"	27,05 α
AN14B-10	40 × 1 1/2"	37,80 α

α = så længe lager haves

Slangeforskruing flad

PA (POLYAMID) - BSPP



Varenr.	Ø × BSPP	DKK
AN46-1	7 × 1/4"	8,20 α
AN46-4	10 × 1/2"	10,25 α
AN46-6	12 × 3/8"	9,00 α
AN46-7	12 × 3/4"	10,75 α
AN46-8	13 × 1/2"	10,25 α
AN46-9	13 × 3/4"	10,95 α
AN46-10	16 × 1/2"	10,45 α
AN46-11	16 × 3/4"	11,20 α
AN46-14	20 × 1"	12,80 α
AN46-15	22 × 1"	13,00 α
AN46-16	25 × 1"	13,20 α
AN46-17	25 × 1 1/4"	18,55 α
AN46-18	30 × 1 1/4"	18,85 α
AN46-20	40 × 1 1/2"	25,75 α

α = så længe lager haves

Pakning indv/udv.

EPDM



Varenr.	ø / Ø	DKK
AN47-4	3/4" / 3/8"	2,37 α
AN47-7	1 1/2" / 1"	4,11 α
AN47-8	2"	7,85 α

α = så længe lager haves

Slangesamler

PA (POLYAMID)



Varenr.	Ø	DKK
AN14D-1	13	17,30 α
AN14D-2	16	19,85 α
AN14D-3	20	21,95 α
AN14D-4	22	21,95 α
AN14D-5	25	23,55 α
AN14D-6	30	28,20 α
AN14D-7	32	30,55 α
AN14D-8	35	34,10 α
AN14D-9	40	36,80 α
AN14D-11	60	80,50 α

α = så længe lager haves

Slangeforskruing 90° flad

PA (POLYAMID) - BSPP



Varenr.	Ø × mm	DKK
AN14C-1	20 × M20*3	15,90 ₺
AN14C-2	25 × M25*3	20,80 ₺
AN14C-3	30 × M30*3	26,55 ₺
AN14C-4	32 × M30*3	28,20 ₺
AN14C-5	35 × M35*3	30,90 ₺
AN14C-6	40 × M40*3	38,50 ₺
AN14C-7	50 × M50*3	57,20 ₺

₺ = så længe lager haves

Slangeforskruing konus

PA (POLYAMID) - BSPP



Varenr.	Ø × mm	DKK
AN46M-1	16 × M20*1,75	12,40 ₺
AN46M-2	20 × M20*1,75	13,50 ₺
AN46M-3	22 × M25*3	14,20 ₺
AN46M-5	30 × M30*3	17,30 ₺
AN46M-6	32 × M30*3	18,55 ₺
AN46M-7	35 × M35*3	20,65 ₺
AN46M-8	40 × M40*3	22,40 ₺
AN46M-9	50 × M50*3	37,50 ₺
AN46M-10	60 × M60*3	48,95 ₺

₺ = så længe lager haves

Adapter

PA (POLYAMID) - BSPP



Varenr.	BSPP × MM	DKK
AN10M-1	3/4" × M20*1,75	7,70 ₺
AN10M-2	1" × M20*1,75	8,05 ₺
AN10M-3	1" × M25*3	8,50 ₺
AN10M-4	1" × M30*3	9,55 ₺
AN10M-5	1" × M35*3	15,35 ₺
AN10M-6	1" × M40*3	16,45 ₺
AN10M-7	1 1/4" × M30*3	14,35 ₺
AN10M-8	1 1/4" × M35*3	15,35 ₺
AN10M-9	1 1/4" × M40*3	16,45 ₺
AN10M-10	1 1/4" × M50*3	20,15 ₺
AN10M-11	1 1/2" × M35*3	16,20 ₺
AN10M-12	1 1/2" × M40*3	16,45 ₺
AN10M-13	1 1/2" × M50*3	20,15 ₺
AN10M-14	2" × M50*3	23,40 ₺
AN10M-15	2" × M60*3	26,40 ₺

₺ = så længe lager haves

SLANGEFITTINGS PP



Max 10bar ved 20°C



-4°C til +60°C



Bredt program af slangefittings i PP, der er egnet til brug ved kemikalier og samtidig med god mekanisk styrke.

Slangenippel

PP (POLYPROPYLEN) - BSPT



Varenr.	Ø × BSPT	DKK
A1-01PP	3 × 1/8"	11,75
A1-1PP	4 × 1/8"	11,75
A1-02PP	3 × 1/4"	11,75
A1-2PP	4 × 1/4"	11,75
A1-4PP	5 × 1/4"	11,75
A1-5PP	6 × 1/8"	11,75
A1-6PP	6 × 1/4"	12,35
A1-7PP	6 × 3/8"	12,35
A1-9PP	8 × 1/8"	11,75
A1-10PP	8 × 1/4"	12,35
A1-11PP	8 × 3/8"	12,35
A1-12PP	10 × 1/8"	11,75
A1-13PP	10 × 1/4"	12,35
A1-14PP	10 × 3/8"	12,35

Slangenippel

PP (POLYPROPYLEN) - BSPT



Varenr.	Ø × BSPT	DKK
A1-18PP	12 × 1/4"	12,20
A1-20PP	12 × 3/8"	12,20
A1-21PP	12 × 1/2"	12,90
A1-22PP	12 × 3/4"	12,90
A1-26PP	15 × 1/2"	20,90
A1-27PP	15 × 3/4"	20,90
A1-26PP-2	16 × 1/4"	16,05
A1-26PP-4	15 × 1/2"	18,05
A1-26PP-5	15 × 1/2"	19,15
A1-28PP	20 × 1/2"	20,90
A1-29PP	20 × 3/4"	20,90
A1-30PP	24 × 3/4"	23,65
A1-30PP-4	25 × 1/2"	23,65
A1-30PP-5	25 × 3/4"	25,10
A1-30PP-6	25 × 1"	27,00

A1-30PP-7	25 × 1 1/4"	31,45
A1-32PP-5	32 × 3/4"	35,50
A1-32PP	32 × 1"	39,20
A1-32PP-7	32 × 1 1/4"	39,20
A1-34PP-4	40 × 1/2"	39,20
A1-34PP-5	40 × 3/4"	39,20
A1-34PP	40 × 1"	39,20
A1-35PP	40 × 1 1/4"	52,60
A1-35PP-8	40 × 1 1/2"	54,05
A1-35PP-9	40 × 2"	54,60
A1-36PP-7	50 × 1 1/4"	56,75
A1-36PP-8	50 × 1 1/2"	56,75
A1-36PP-9	50 × 2"	56,75
A1-37PP-7	63 × 1 1/4"	60,05
A1-37PP-8	63 × 1 1/2"	65,50
A1-37PP-9	63 × 2"	65,50



Slangenippel

PP (POLYPROPYLEN) - BSPP



Varenr.	Ø × BSPP	DKK
A400-1	8 × 1/4"	12,10
A400-2	8 × 3/8"	12,90
A400-3	10 × 1/4"	12,10
A400-4	10 × 3/8"	12,90
A400-5	10 × 1/2"	17,90
A400-6	13 × 1/4"	12,10
A400-7	13 × 3/8"	12,90
A400-8	13 × 1/2"	17,90
A400-9	13 × 3/4"	19,75
A400-10	16 × 3/8"	12,90
A400-11	16 × 1/2"	17,90
A400-12	16 × 3/4"	19,75
A400-13	20 × 1/2"	19,10
A400-14	20 × 3/4"	19,75
A400-15	20 × 1"	22,75
A400-16	20 × 1 1/4"	24,35
A400-17	22 × 3/4"	19,75
A400-18	22 × 1"	22,75
A400-19	25 × 3/4"	20,30
A400-20	25 × 1"	22,75
A400-21	25 × 1 1/4"	24,35
A400-22	30 × 1"	22,75
A400-23	30 × 1 1/4"	33,55
A400-24	30 × 1 1/2"	34,40
A400-25	32 × 1"	29,60
A400-26	32 × 1 1/4"	33,55
A400-27	32 × 1 1/2"	34,40
A400-28	35 × 1 1/4"	33,55
A400-29	35 × 1 1/2"	35,25
A400-30	38 × 1 1/4"	33,80
A400-31	38 × 1 1/2"	34,95
A400-32	40 × 1 1/4"	33,80
A400-33	40 × 1 1/2"	34,95
A400-34	45 × 1 1/2"	35,80
A400-35	50 × 1 1/2"	40,05
A400-36	50 × 2"	46,35
A400-37	60 × 2"	54,80
A400-38	60 × 2 1/2"	57,60
A400-39	75 × 3"	72,40

Slangenippel m. indiv. gevind

PP (POLYPROPYLEN) - BSPP



Varenr.	Ø × BSPP	DKK
A101-1PP	15 × 1/2"	15,70 □
A101-2PP	19 × 1/2"	15,70 □
A101-3PP	19 × 1 1/4"	26,80
A101-4PP	21 × 1 1/4"	15,70
A101-5PP	25 × 1 1/4"	26,80
A101-6PP	30 × 1 1/4"	26,80
A101-7PP	32 × 1 1/4"	26,80
A101-8PP	35 × 1 1/4"	26,80
A101-9PP	40 × 1 1/4"	26,80
A101-10PP	35 × 1 1/2"	19,10
A101-11PP	40 × 1 1/2"	28,85
A101-12PP	45 × 1 1/2"	37,10
A101-13PP	50 × 1 1/2"	39,15
A101-14PP	45 × 2"	39,15
A101-15PP	50 × 2"	39,15
A101-16PP	60 × 2"	39,15

□ = NYLON

Slangenippel 90°

PP (POLYPROPYLEN) - BSPT



Varenr.	Ø × BSPT	DKK
A2-01PP	3 × 1/4"	17,80
A2-1PP	4 × 1/8"	17,80
A2-2PP	4 × 1/4"	17,80
A2-4PP	5 × 1/4"	17,80
A2-5PP	6 × 1/8"	17,80
A2-6PP	6 × 1/4"	17,80
A2-7PP	6 × 3/8"	17,80
A2-9PP	8 × 1/8"	17,80
A2-10PP	8 × 1/4"	17,80
A2-11PP	8 × 3/8"	19,15
A2-12PP	10 × 1/8"	17,80
A2-13PP	10 × 1/4"	17,80
A2-14PP	10 × 3/8"	73,15

Slangenippel 90°

PP (POLYPROPYLEN) - BSPP



Varenr.	Ø × BSPP	DKK
A2-18PP	12 × 1/4"	12,20
A2-20PP	12 × 3/8"	12,20
A2-21PP	12 × 1/2"	12,90
A2-22PP	12 × 3/4"	12,90
A2-26PP	16 × 1/2"	20,90
A2-27PP	16 × 3/4"	23,65
A2-28PP	20 × 1/2"	20,90
A2-29PP	20 × 3/4"	23,65
A2-30PP-5	25 × 3/4"	38,10
A2-30PP	25 × 1"	38,10
A2-31PP-5	32 × 3/4"	38,80
A2-31PP	32 × 1"	39,20
A2-31PP-7	32 × 1 1/4"	39,20
A2-34PP-6	40 × 1"	48,35
A2-34PP-7	40 × 1 1/4"	51,25

Slangenippel 90°

PP (POLYPROPYLEN) - BSPP



Varenr.	Ø × BSPP	DKK
A2C-20	12 × 3/8"	36,40
A2C-25	16 × 3/8"	33,80
A2C-24	12 × 1/2"	36,40
A2C-26	14 × 1/2"	36,40
A2C-28	19 × 1/2"	36,40
A2C-27	14 × 3/4"	40,40
A2C-29	19 × 3/4"	40,40
A2C-30	25 × 3/4"	44,90
A2C-30-1	20 × 1"	41,80
A2C-31	25 × 1"	44,90
A2C-31-1	30 × 1"	50,30
A2C-32	32 × 1"	50,30
A2C-35-1	25 × 1 1/4"	49,40
A2C-35-2	30 × 1 1/4"	57,10
A2C-35-3	32 × 1 1/4"	57,10
A2C-35-4	35 × 1 1/4"	54,00
A2C-35-5	38 × 1 1/4"	55,20
A2C-35	40 × 1 1/4"	61,70
A2C-36	30 × 1 1/2"	59,80
A2C-37	32 × 1 1/2"	59,80
A2C-38	35 × 1 1/2"	70,15
A2C-39	38 × 1 1/2"	60,90
A2C-40	40 × 1 1/2"	60,90
A2C-41	50 × 2"	103,50
A2C-42	52 × 2"	103,50
A2C-43	60 × 3"	109,00
A2C-44	75 × 3"	109,00

Slangenippel 45°

PP (POLYPROPYLEN) - BSPP



Varenr.	Ø × BSPP	DKK
A2C45-35-2	30 × 1 1/4"	70,15
A2C45-35-3	35 × 1 1/4"	70,15
A2C45-35	40 × 1 1/4"	74,80
A2C45-36	30 × 1 1/2"	73,15
A2C45-38	35 × 1 1/2"	83,55
A2C45-40	40 × 1 1/2"	74,30

Slangenippel T-stk

PP (POLYPROPYLEN) - BSPT



Varenr.	Ø × BSPT × Ø	DKK
A10-1PP	4 × 1/8" × 4	17,80
A10-2PP	4 × 1/4" × 4	17,80
A10-4PP	5 × 1/4" × 5	17,80
A10-5PP	6 × 1/8" × 6	17,80
A10-6PP	6 × 1/4" × 6	17,80
A10-7PP	6 × 3/8" × 6	19,15
A10-10PP	8 × 1/4" × 8	17,80
A10-11PP	8 × 3/8" × 8	19,15
A10-12PP	10 × 1/8" × 10	17,80
A10-13PP	10 × 1/4" × 10	17,80
A10-14PP	10 × 3/4" × 10	19,15

Slangenippel 90° m. indv. gevind

PP (POLYPROPYLEN) - BSPP

PP (POLYPROPYLEN) - BSPP



Varenr.	Ø × BSPP	DKK
A102-1PP	19 × 3/4"	15,70
A102-2PP	22 × 3/4"	15,70
A102-3PP	25 × 3/4"	17,55
A102-4PP	30 × 3/4"	17,55
A102-5PP	30 × 1"	20,30

Slangenippel T-stk

PP (POLYPROPYLEN) - BSPT

PP (POLYPROPYLEN) - BSPT



Varenr.	Ø × BSPT × Ø	DKK
A10-18PP	12 × 1/4" × 12	12,20
A10-20PP	12 × 3/8" × 12	12,90
A10-21PP	12 × 1/2" × 12	12,90
A10-22PP	12 × 3/4" × 12	13,70
A10-27PP	16 × 3/4" × 16	19,75
A10-26PP-3	16 × 3/8" × 16	20,00
A10-26PP-4	16 × 1/2" × 16	19,75
A10-28PP	20 × 1/2" × 20	22,45
A10-29PP	20 × 3/4" × 20	22,45
A10-30PP-4	25 × 1/2" × 25	35,50
A10-30PP-5	25 × 3/4" × 25	42,05
A10-30PP	25 × 1" × 25	42,05
A10-31PP	32 × 1" × 32	42,05
A10-31PP-7	32 × 1 1/4" × 32	42,05
A10-32PP-6	40 × 1" × 40	49,10
A10-32PP-7	40 × 1 1/4" × 40	49,10

Skotgennemføring 90°

PP (POLYPROPYLEN) - BSPP

PP (POLYPROPYLEN) - BSPP



Varenr.	Ø × BSPP	Ext. dim	DKK
A2CS-24	13 × 1/2"	22 mm	13,70
A2CS-26	15 × 1/2"	22 mm	13,70
A2CS-28	20 × 1/2"	22 mm	13,70

Slangeforskruing flad

PP (POLYPROPYLEN) / EPDM - BSPP



Varenr.	Ø × BSPP	DKK
A105-1PP	10 × 3/8"	13,30
A105-2PP	10 × 1/2"	14,50
A105-3PP	13 × 1/2"	14,50
A105-4PP	15 × 3/4"	18,75
A105-5PP	20 × 3/4"	19,40
A105-6PP	20 × 1"	20,60
A105-7PP	25 × 1"	22,10
A105-8PP	30 × 1 1/4"	25,85
A105-9PP	40 × 1 1/2"	37,50

Skotgennemføring studs/studs

PP (POLYPROPYLEN) - BSPP



Varenr.	Ø × BSPP	Ext. dim	DKK
A109-1	25 × 1"	34 mm	20,90

Pakning til udv. gevind

EPDM



Til flade pakflader

Varenr.	Dim	Ø/ø	- -	DKK
A139-4	1/2"	33/21	2	4,43
A139-5	3/4"	39,5/27,5	2,5	5,10
A139-6	1"	45/33	3	5,35
A139-7	1 1/4"	60/40	4	6,35
A139-8	1 1/2"	67/47	3	9,30
A139-9	2"	86/59	4	10,85
A139-10	2 1/2"	94,5/76	4	13,70
A139-11	3"	110/90	6	14,75

Slangeforskruing flad

PP (POLYPROPYLEN) / EPDM - BSPP



Varenr.	Ø × BSPP	DKK
A13-1	10 × 3/4"	19,40
A13-2	12 × 1/2"	19,40
A13-3	12 × 3/4"	19,40
A13-6	12 × 1"	20,90
A13-4	16 × 3/4"	20,30
A13-7	16 × 1"	21,85
A13-5	19 × 3/4"	20,30
A13-8	19 × 1"	21,85

Skotgennemføring 90°

PP (POLYPROPYLEN) - BSPP



Med slangestuds			
Varenr.	Ø × BSPP	Ext. dim	DKK
A109-10	15 × 1/2"	22 mm	19,40
A109-11	20 × 3/4"	27 mm	22,45
A109-12	26 × 1"	34 mm	24,85

Slangesamler

PP (POLYPROPYLEN)



Varenr.	Ø	DKK
A6-01PP	3	12,00
A6-1PP	4	19,15
A6-2PP	5	19,15
A6-3PP	6	11,75
A6-4PP	8	11,75
A6-5PP	10	11,75

Slangeforskruing 90° flad

PP (POLYPROPYLEN) / EPDM - BSPP



Varenr.	Ø × BSPP	DKK
A106-1PP	10 × 1/2"	20,30
A106-2PP	13 × 3/4"	24,10
A106-3PP	20 × 3/4"	24,35
A106-4PP	25 × 1"	29,30
A106-5PP	30 × 1 1/4"	41,80
A106-6PP	40 × 1 1/2"	57,10

Kontramøtrik

PP (POLYPROPYLEN) - BSPP



Varenr.	BSPP	DKK
A129-3	3/8"	6,35
A129-4	1/2"	6,95
A129-5	3/4"	9,10
A129-6	1"	9,20
A129-7	1 1/4"	9,60
A129-8	1 1/2"	14,75
A129-9	2"	20,60
A129-10	2 1/2"	21,85
A129-11	3"	34,95

Slangesamler PP (POLYPROPYLEN)



Varenr.	Ø	DKK
A6-8PP	16	9,30
A6-9PP	20	10,60
A6-10PP-16	25×16	11,50
A6-10PP-20	25×20	12,35
A6-10PP	25	13,30
A6-11PP-25	32×25	16,40
A6-11PP	32	19,75
A6-12PP	35	27,70
A6-13PP-25	40×25	29,45
A6-13PP-32	40×32	31,15
A6-13PP	40	33,00
A6-14PP-40	50×40	35,50
A6-14PP	50	39,25
A6-15PP-40	63×40	44,80
A6-15PP-50	63×50	47,00
A6-15PP	63	49,15

Slangesamler reduktion PP (POLYPROPYLEN)



Varenr.	Ø	DKK
A5-01PP	4 × 3	18,55
A5-02PP	5 × 3	19,15
A5-1PP	5 × 4	18,85
A5-2PP-1	6 × 3	19,15
A5-2PP	6 × 4	19,15
A5-3PP	6 × 5	19,15
A5-5PP	8 × 6	19,15
A5-6PP	10 × 6	19,15
A5-7PP	10 × 8	19,15
A5-8PP-1	12 × 6	19,15
A6-7PP-8	12 × 8	8,05 ₪
A5-9PP	12 × 10	19,15
A5-12PP-1	16 × 6	19,15
A6-8PP-12	16 × 12	9,75 ₪
A6-9PP-16	20 × 16	10,55 ₪

₪ = sort

Slangesamler 90° PP (POLYPROPYLEN)



Varenr.	Ø	DKK
A4-01PP	3	20,50
A4-1PP	4	28,15
A4-2PP	5	28,15
A4-3PP	6	16,40
A4-4PP	8	17,80
A4-5PP	10	17,80

Slangesamler 90° PP (POLYPROPYLEN)



Varenr.	Ø	DKK
A4-6PP	12	27,20
A4-8PP	16	20,90
A4-9PP	20	23,65
A4-10PP	25	23,65
A4-11PP	32	23,65
A4-13PP	40	28,35

Slangesamler 90° reduktion PP (POLYPROPYLEN)



Varenr.	Ø	DKK
A3-2PP	6 × 3	47,45
A3-3PP	8 × 6	17,25
A3-3PP-1	10 × 6	19,15
A3-4PP	12 × 6	19,15
A3-5PP	12 × 10	19,15

Slangesamler 90° reduktion PP (POLYPROPYLEN)



Varenr.	Ø	DKK
A4-6PP-16	16 × 12	12,20
A4-6PP-20	20 × 12	12,90
A4-9PP-25	25 × 20	23,65
A4-10-1PP	32 × 25	23,65

Slangesamler T-stk PP (POLYPROPYLEN)



Varenr.	Ø	DKK
A9-01PP	3	21,60
A9-1PP	4	28,15
A9-2PP	5	32,20
A9-3PP	6	17,80
A9-4PP	8	17,80
A9-5PP	10	17,80

Slangesamler T-stk PP (POLYPROPYLEN)



Varenr.	Ø	DKK
A9-6PP	12	12,20
A9-8PP	16	19,75
A9-9PP	20	22,45
A9-10PP	25	24,85
A9-11PP	32	42,05
A9-13PP	40	59,00

Slangesamler T-stk red. PP (POLYPROPYLEN)



Varenr.	Ø	DKK
A8-01PP	3 × 4 × 3	38,80
A8-02PP	3 × 6 × 3	40,70
A8-1PP-1	6 × 3 × 6	40,70
A8-1PP-2	6 × 4 × 6	40,70
A8-2PP	6 × 5 × 6	40,70
A8-2PP-1	6 × 10 × 6	20,00
A8-2PP-2	6 × 16 × 6	20,00
A8-3PP-1	10 × 6 × 10	19,15
A8-4PP-1	12 × 6 × 12	20,00
A8-5PP-1	12 × 8 × 12	19,15
A8-5PP	12 × 10 × 12	19,15
A8-7PP-1	19 × 10 × 19	21,50
A8-7PP-2	19 × 12 × 19	21,30

Slangesamler Y-stk PP (POLYPROPYLEN)



Varenr.	Ø	DKK
A7-01PP	3	20,50
A7-1PP	4	34,95
A7-1PP-1	5	34,95
A7-2PP	6	42,35
A7-3PP	8	43,15
A7-4PP	10	43,15
A7-5PP	12	45,80
A7-6PP	16	60,90
A7-7PP	19	61,45
A7-8PP	25	77,25

Slangesamler kryds PP (POLYPROPYLEN)



Varenr.	Ø	DKK
A50-1PP	3	29,25
A50-2PP	4	31,95
A50-3PP	5	35,20
A50-4PP	6	31,45
A50-5PP	10	44,25

Slangeprop rund PP (POLYPROPYLEN)



Varenr.	Ø	DKK
A112-3	3	11,50
A112-4	4	12,10
A112-5	5	18,95
A112-6	6	21,60
A112-10	10	23,20
A112-12	12	23,20

T-stk slangesamler red. PP (POLYPROPYLEN)



Varenr.	Ø	DKK
A9-8PP-20	16 × 20 × 16	20,80
A9-8PP-25	16 × 25 × 16	22,95
A9-9PP-16	20 × 16 × 20	22,45
A9-9PP-25	20 × 25 × 20	23,50
A9-10PP-16	25 × 16 × 25	24,10
A9-10PP-20	25 × 20 × 25	24,85
A9-10-1PP	25 × 32 × 25	42,05
A9-11PP-25	32 × 25 × 32	32,75
A9-11PP-40	32 × 40 × 32	49,15
A9-12PP-32	40 × 32 × 40	54,60

Slangesamler Y-stk red. PP (POLYPROPYLEN)



Varenr.	Ø	DKK
A53-1PP	6 × 2-3	42,35
A53-2PP	8 × 2-5	43,15
A53-3PP	10 × 2-6	47,75
A53-4PP	12 × 2-10	45,80
A53-5PP	16 × 2-12	67,75
A53-6PP	19 × 2-16	68,25
A53-7PP	25 × 2-19	77,25

Slangesamler Y-stk red. PP (POLYPROPYLEN)



Varenr.	Ø	DKK
A51-4PP	25 × 2-25	163,00
A51-5PP	30 × 2-25	163,00

Slangeprop sekskant PP (POLYPROPYLEN)



Varenr.	Ø	DKK
A112-16	16	23,35
A112-20	20	23,35
A112-25	25	23,35
A112-32	32	23,35
A112-40	40	23,35
A112-50	50	23,50
A112-63	63	33,80



Brug O-ring ved samling med fittings.



Brug pakning ved samling af 2 flader.

SLANGEFITTINGS PP GLASFIBER FORSTÆRKET



Max 10bar ved 20°C



+4°C til +100°C



Nogle slangefittings i PP, der er egnet til brug ved kemikalier og samtidig har høj mekanisk styrke.

Slangenippel

PP (POLYPROPYLEN) - BSPT



Varenr.	Ø × BSPT	DKK
AB14-2	16 × 3/8"	8,35 ₺
AB14-4	25 × 3/4"	13,50 ₺
AB14-5	30 × 1"	15,90 ₺
AB14-6	40 × 1 1/4"	30,25 ₺
AB14-7	50 × 1 1/2"	35,80 ₺

₺ = så længe lager haves

Slangeforskrunding flad

PP (POLYPROPYLEN) - BSPP



Varenr.	Ø × BSPP	DKK
AB46-1	12 × 3/8"	17,70 ₺
AB46-2	16 × 1/2"	23,40 ₺
AB46-5	30 × 1 1/4"	38,80 ₺

₺ = så længe lager haves

PAKNINGER



Pakninger og O-ringe i diverse materialer og både beregnet til indvendig og udvendig gevind.

Pakning til indv. gev. KLINGERIT

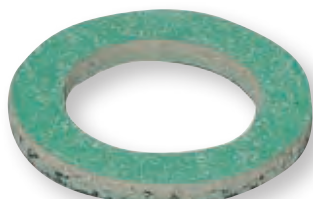

Varenr.	dim	Ø/ø	- -	DKK
E16-10I	1/8"	8/4	2	6,80
E16-11I	1/4"	11/6	2	6,80
E16-12I	3/8"	14,5/8	2	2,38
E16-13I	1/2"	18/12,5	2	3,46
E16-14I	3/4"	24/16	2	5,10
E16-15I	1"	30/25	2	9,90
E16-16I	1 1/4"	38/31	2	14,60
E16-17I	1 1/2"	44/36	2	31,30

Pakning til udv. gevind EPDM



Til flade pakflader				
Varenr.	Dim	Ø/ø	- -	DKK
A139-4	1/2"	33/21	2	4,43
A139-5	3/4"	39,5/27,5	2,5	5,10
A139-6	1"	45/33	3	5,35
A139-7	1 1/4"	60/40	4	6,35
A139-8	1 1/2"	67/47	3	9,30
A139-9	2"	86/59	4	10,85
A139-10	2 1/2"	94,5/76	4	13,70
A139-11	3"	110/90	6	14,75

Pakning til udv. gevind ALUMINIUM

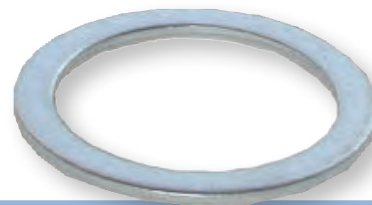

Varenr.	dim	Ø/ø	- -	DKK
E16-9	M5	8,5/5	1	,69
E16-0	1/8"	14/10,2	1	,69
E16-1	1/4"	17,5/13,5	1,5	1,13
E16-2	3/8"	22/17,2	1,5	1,42
E16-3	1/2"	27/21,3	1,5	1,71
E16-4	3/4"	32/27	1,5	2,27
E16-5	1"	39/33,7	1,5	3,57
E16-6	1 1/4"	50/42,4	1,5	7,75
E16-7	1 1/2"	55/48,3	1,5	8,50

Pakning til indv. gev. GUMMI



Varenr.	dim	Ø/ø	- -	DKK
E16-21I	1/4"	11/6	1,5	3,71
E16-23I	1/2"	18/12,5	2	1,42
E16-24I	3/4"	24/16	2	2,04
E16-25I	1"	30/25	2	3,92
E16-26I	1 1/4"	38/31	2	5,55
E16-27I	1 1/2"	44/36	2	14,00

Pakning til indv. gev. FIBER



Varenr.	dim	Ø/ø	DKK
E16-32I	3/8"	14,5/8	1,82
E16-33I	1/2"	18/12,5	1,94
E16-34I	3/4"	24/16	4,94
E16-35I	1"	30/25	4,20
E16-36I	1 1/4"	38/31	6,10
E16-37I	1 1/2"	44/36	17,10

Pakning til udv. gevind KOBBER



Varenr.	dim	Ø/ø	- -	DKK
E16-19	M5	8,5/5	1	1,42
E16-10	1/8"	14/10,2	2	1,59
E16-11	1/4"	17,5/13,5	1,5	2,67
E16-12	3/8"	22/17,2	1,5	4,32
E16-13	1/2"	27/21,3	1,5	6,00
E16-14	3/4"	32/27	1,5	7,15
E16-15	1"	39/33,7	1,5	16,50
E16-16	1 1/4"	50/42,4	1,5	37,10
E16-17	1 1/2"	55/48,3	1,5	UDGÅET
E16-18	2"	70/60,3	1,5	57,70

Hvor måles pakningen?



Udvendig



Indvendig

Pakning til udv. gevind

NYLON



Varenr.	dim	Ø/ø	- -	DKK
E16-29	M5	8,5/5	1	1,13
E16-20	1/8"	14/10,2	1	1,42
E16-21	1/4"	17,5/13,5	1,5	2,55
E16-22	3/8"	22/17,2	1,5	4,10
E16-23	1/2"	27/21,3	1,5	4,77
E16-24	3/4"	32/27	1,5	11,55
E16-25	1"	39/33,7	1,5	14,45
E16-26	1 1/4"	50/42,4	1,5	11,80
E16-27	1 1/2"	55/48,3	1,5	13,00
E16-28	2"	70/60,3	1,5	21,20

Pakning til udv. gevind

FIBER



Varenr.	dim	Ø/ø	- -	DKK
E16-39	M5	8,5/5	1	,69
E16-30	1/8"	14/10,2	1	5,40
E16-31	1/4"	18/13,8	1	6,00
E16-32	3/8"	22/17,2	1,5	2,15
E16-33	1/2"	27/21,3	1,5	6,00
E16-34	3/4"	32/27	1,5	4,52
E16-35	1"	39/33,7	1,5	4,52
E16-38	2"	70/60,3	1,5	8,65

O-ring/pakning til udv.

EPDM



Til tætning mellem fittings

Varenr.	Dim	Ø	- -	DKK
A140-4	1/2"	20,2	2,6	5,35
A140-5	3/4"	25,0	2,6	5,95
A140-6	1"	29,8	2,6	6,35
A140-7	1 1/4"	39,7	3,5	6,70
A140-8	1 1/2"	47,2	3,5	7,90
A140-9	2"	58,7	3,5	9,85
A140-10	2 1/2"	74,6	3,5	15,70
A140-11	3"	85,5	3,5	17,90

SLANGER TIL LUFT/VAND



Disse slanger leveres kun i hele ruller, til gengæld kan de fås i både 100m og 25m længder. 100m leveres i kasser, 25m blot som en rulle.

Slangestørrelser angives typisk i mm og svarer til følgende mål:
4mm = 1/8

Multislange

Multislanger kan produceres i både PA og PE materiale. De kan leveres fra 2 til 4 slanger i én multislange.

Farvesammensætninger og materialer kan varieres efter ønske. Ring og forhør nærmere herom.

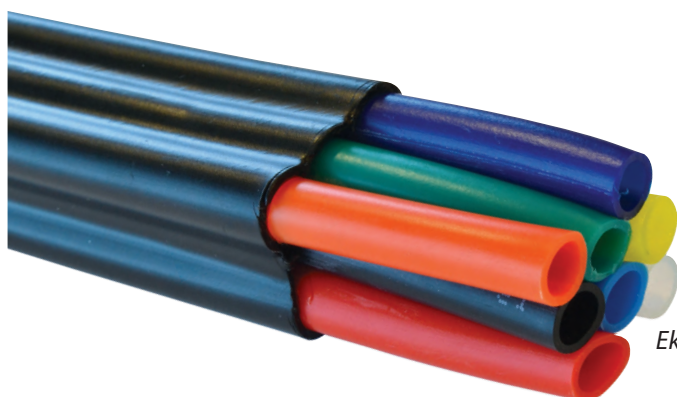

Eksemplet her er leveret til marine brug (skibsværft).

Trykluftolie

RANDO HD32



Rando HD anbefales til brug i alle typer højtydende industrielle og mobile hydrauliske systemer, der arbejder under moderate omgivelsestemperaturer, høje tryk og pumpehastigheder.

Varenr.	L	DKK
S1010-1	1	156,25
S1010-2	2,5	364,25

Luftslange 100m sort

PA (POLYAMID)



UV bestandig

Varenr.	Ø/ø	BAR	U	DKK
J00310402	4/2	56	20	608,25
J00310604	6/4	33	35	933,75
J00310806	8/6	24	40	1334,00
J00311008	10/8	19	60	1667,75
J00311210	12/10	15	85	2035,50

Luftslange 100m neutral PA (POLYAMID)

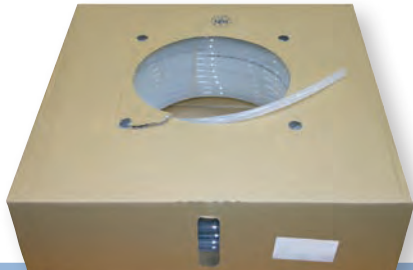

Varenr.	Ø/ø	BAR	U	DKK
J10300316	3/1,5	45	15	438,75
J10300402	4/2	44	15	545,00
J10300604	6/4	27	30	879,25
J10300806	8/6	19	40	1257,75
J10301008	10/8	15	50	1634,75
J10301210	12/10	12	60	1962,25
J10301512	15/12	15	90	2867,75
J10301613	16/13	14	100	3703,00
J10301815	18/15	12	150	4458,00
J10302218	22/18	13	300	5471,50
J10302823	28/24	13	300	8724,25

U = bøjeradius i mm

Luftslange 100m blå PA (POLYAMID)

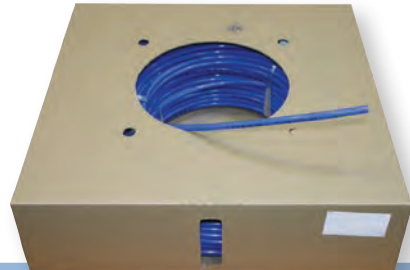

Varenr.	Ø/ø	BAR	U	DKK
J10340316	3/1,5	45	15	438,75
J10340402	4/2	44	15	545,00
J10340604	6/4	27	30	879,25
J10340806	8/6	19	40	1257,75
J10341008	10/8	15	50	1634,75
J10341210	12/10	12	60	1962,25
J10341512	15/12	15	90	2867,75
J10341613	16/13	14	100	3703,00
J10341815	18/15	12	150	4458,00
J10342823	28/24	13	300	8724,25

U = bøjeradius i mm

Luftslange 100m grøn PA (POLYAMID)

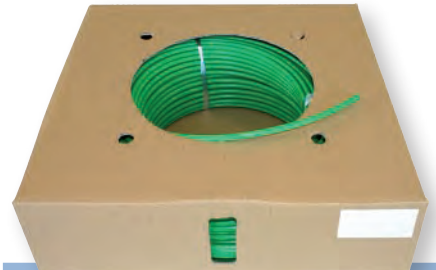

Varenr.	Ø/ø	BAR	U	DKK
J10380316	3/1,5	45	15	438,75
J10380402	4/2	44	15	545,00
J10380604	6/4	27	30	879,25
J10380806	8/6	19	40	1257,75
J10381008	10/8	15	50	1634,75
J10381210	12/10	12	60	1962,25
J10381512	15/12	15	90	2867,75
J10381613	16/13	14	100	3703,00
J10381815	18/15	12	150	4458,00
J10382218	22/18	13	300	5471,50
J10382823	28/24	13	300	8724,25

U = bøjeradius i mm

Luftslange 100m sort PA (POLYAMID)



Varenr.	Ø/ø	BAR	U	DKK
J10310316	3/1,5	45	15	438,75
J10310402	4/2	44	15	545,00
J10310604	6/4	27	30	879,25
J10310806	8/6	19	40	1257,75
J10311008	10/8	15	50	1634,75
J10311210	12/10	12	60	1962,25
J10311512	15/12	15	90	2867,75
J10311613	16/13	14	100	3703,00
J10311815	18/15	12	150	4458,00
J10312218	22/18	13	300	5471,50
J10312823	28/24	13	300	8724,25

U = bøjeradius i mm

Luftslange 100m gul PA (POLYAMID)

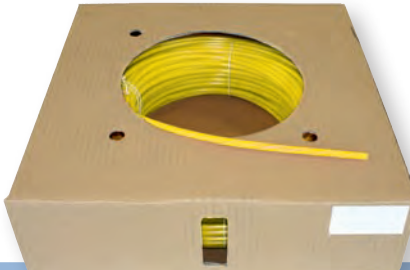

Varenr.	Ø/ø	BAR	U	DKK
J10350316	3/1,5	45	15	438,75
J10350402	4/2	45	15	545,00
J10350604	6/4	27	30	879,25
J10350806	8/6	19	40	1257,75
J10351008	10/8	15	50	1634,75
J10351210	12/10	12	60	1962,25
J10351512	15/12	15	90	2867,75
J10351613	16/13	14	100	3703,00
J10351815	18/15	12	150	4458,00
J10352218	22/18	13	300	5471,50
J10352823	28/24	13	300	8724,25

U = bøjeradius i mm

Luftslange 100m rød PA (POLYAMID)

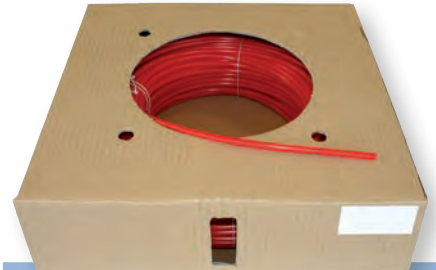

Varenr.	Ø/ø	BAR	U	DKK
J10370316	3/1,5	45	15	438,75
J10370402	4/2	44	15	545,00
J10370604	6/4	27	30	879,25
J10370806	8/6	19	40	1257,75
J10371008	10/8	15	50	1634,75
J10371210	12/10	12	60	1962,25
J10371512	15/12	15	90	2867,75
J10371613	16/13	14	100	3703,00
J10371815	18/15	12	150	4458,00
J10372218	22/18	13	300	5471,50
J10372823	28/24	13	300	8724,25

U = bøjeradius i mm

Max. arbejdstryk beregning

Max. arbejdstryk beregnes vha. følgende formel:

$$\text{Max. arbejdstryk} = \frac{2s \times R}{\varnothing}$$

- 2s = 2 x godstykkelse
- Ø = beregningsdiameter (indv. Ø + (1 x godstykkelse))
- R = beregningskoefficient (materialestyrke)

Koefficient for vore slanger ved 23°C:

PA = 50
PE = 24
PU = 25

Max. arbejdstryk eksempel

PA-slange Ø10x8

Koefficient: 50

$$\text{Max. arbejdstryk} = \frac{4 \times 50}{9} = 22,22 \text{ ATM (22,5 bar)}$$

Omregningsfaktor: 1 ATM = 1,01325 bar

Beregningerne er kun vejledende, da de påvirkes af mange faktorer afhængigt af den aktuelle brug.

POLYAMIDSLANGE (PA)

Fleksibel slange, anvendes i regulerings-, måle-, styre- og laboratorietechnik, medicin og elektronik, samt pneumatik og hydraulik.

PA slange er særdeles bestandig mod: olie, fedt, brændstof, organiske opløsningsmidler, vandig syre og diverse saltopløsninger. Temperatur fra -40° til +80°C, kort til +100°C.

Trykangivelser er ved 20°C.
Velegnet til push-in fittings.

Luftslange 25m neutral PA (POLYAMID)



Leveres uden kasse

Varenr.	Ø/ø	BAR	U	DKK
J10100402	4/2	44	15	182,50
J10100604	6/4	27	30	293,25
J10100806	8/6	19	40	418,25
J10101008	10/8	15	50	545,00
J10101210	12/10	12	60	654,50
J10101512	15/12	15	90	1047,75
J10101613	16/13	14	100	1010,00
J10101815	18/15	12	150	1486,50
J10102218	22/18	13	300	1824,25
J10102823	28/24	13	300	2907,75

U = bøjeradius i mm

Luftslange 25m blå PA (POLYAMID)



Leveres uden kasse

Varenr.	Ø/ø	BAR	U	DKK
J10140402	4/2	44	15	182,50
J10140604	6/4	27	30	293,25
J10140806	8/6	19	40	418,25
J10141008	10/8	15	50	545,00
J10141210	12/10	12	60	654,50
J10141512	15/12	15	90	952,50
J10141613	16/13	14	100	1010,00
J10141815	18/15	17	150	1486,50
J10142218	22/18	13	300	1824,25
J10142823	28/24	13	300	2907,75

U = bøjeradius i mm

Luftslange 25m grøn PA (POLYAMID)



Leveres uden kasse

Varenr.	Ø/ø	BAR	U	DKK
J10180402	4/2	44	15	182,50
J10180604	6/4	27	30	293,25
J10180806	8/6	19	40	418,25
J10181008	10/8	15	50	545,00
J10181210	12/10	12	60	654,50
J10181512	15/12	15	90	952,50
J10181613	16/13	14	100	1047,75
J10181815	18/15	12	150	1486,50
J10182218	22/18	13	300	1824,25
J10182823	28/24	13	300	2907,75

U = bøjeradius i mm

Luftslange 25m sort PA (POLYAMID)



Leveres uden kasse

Varenr.	Ø/ø	BAR	U	DKK
J10110402	4/2	44	15	182,50
J10110604	6/4	27	30	293,25
J10110806	8/6	19	40	418,25
J10111008	10/8	15	50	545,00
J10111210	12/10	12	60	654,50
J10111512	15/12	15	90	952,50
J10111613	16/13	14	100	1010,00
J10111815	18/15	12	150	1486,50
J10112218	22/18	13	300	1824,25
J10112823	28/24	13	300	2907,75

U = bøjeradius i mm

Luftslange 25m gul PA (POLYAMID)



Leveres uden kasse

Varenr.	Ø/ø	BAR	U	DKK
J10150402	4/2	44	15	182,50
J10150604	6/4	27	30	293,25
J10150806	8/6	19	40	418,25
J10151008	10/8	15	50	545,00
J10151210	12/10	12	60	654,50
J10151512	15/12	15	90	952,50
J10151613	16/13	14	100	1047,75
J10151815	18/15	12	150	1486,50
J10152218	22/18	13	300	1824,25
J10152823	28/24	13	300	2907,75

U = bøjeradius i mm

Luftslange 25m rød PA (POLYAMID)



Leveres uden kasse

Varenr.	Ø/ø	BAR	U	DKK
J10170402	4/2	44	15	182,50
J10170604	6/4	27	30	293,25
J10170806	8/6	19	40	418,25
J10171008	10/8	15	50	545,00
J10171210	12/10	12	60	654,50
J10171512	15/12	15	90	952,50
J10171613	16/13	14	100	1047,75
J10171815	18/15	12	150	1486,50
J10172218	22/18	13	300	1824,25
J10172823	28/24	13	300	2907,75

U = bøjeradius i mm

Max. arbejdstryk beregning

Max. arbejdstryk beregnes vha. følgende formel:

$$\text{Max. arbejdstryk} = \frac{2s \times R}{\emptyset}$$

- 2s = 2 x godstykkelse
- Ø = beregningsdiameter (indv. Ø + (1 x godstykkelse))
- R = beregningskoefficient (materialestyrke)

Koefficient for vore slanger ved 23°C:

PA = 50

PE = 24

PU = 25

Max. arbejdstryk eksempel

PA-slange Ø10x8

Koefficient: 50

$$\text{Max. arbejdstryk} = \frac{4 \times 50}{9} = 22,22 \text{ ATM (22,5 bar)}$$

Omregningsfaktor: 1 ATM = 1,01325 bar

Beregningerne er kun vejledende, da de påvirkes af mange faktorer afhængigt af den aktuelle brug.

POLYAMIDSLANGE (PA)

Fleksibel slange, anvendes i regulerings-, måle-, styre- og laborieteknik, medicin og elektronik, samt pneumatik og hydraulik.

PA slange er særdeles bestandig mod: olie, fedt, brændstof, organiske opløsningsmidler, vandig syre og diverse saltopløsninger. Temperatur fra -40° til +80°C, kort til +100°C.

Trykangivelser er ved 20°C.

Velegnet til push-in fittings.

Luftslange 100m neutral PE (POLYETHYLEN)



Varenr.	Ø/ø	BAR	U	DKK
J20300316	3/1,5	-	-	152,50
J20300402	4/2	21	18	230,00
J20300604	6/4	13	28	246,50
J20300806	8/6	9	40	358,75
J20301008	10/8	7	57	439,75
J20301210	12/10	6	75	539,75
J20301512	15/12	7	-	793,25
J20301612	16/12	9	-	1100,25
J20301814	18/14	8	-	1249,50

U = bøjeradius i mm

Luftslange 100m blå PE (POLYETHYLEN)

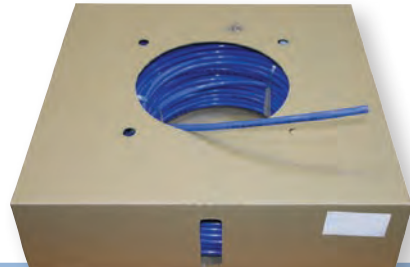

Varenr.	Ø/ø	BAR	U	DKK
J20340316	3/1,5	-	-	148,00
J20340402	4/2	21	18	230,00
J20340604	6/4	13	28	246,50
J20340806	8/6	9	40	358,75
J20341008	10/8	7	57	439,75
J20341210	12/10	6	75	539,75
J20341512	15/12	7	-	793,25
J20341612	16/12	9	-	1100,25
J20341814	18/14	8	-	1249,50

U = bøjeradius i mm

Luftslange 100m grøn PE (POLYETHYLEN)

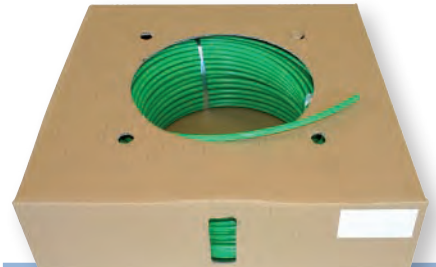

Varenr.	Ø/ø	BAR	U	DKK
J20380402	4/2	21	18	230,00
J20380604	6/4	13	28	246,50
J20380806	8/6	9	40	358,75
J20381008	10/8	7	57	439,75
J20381210	12/10	6	75	539,75
J20381612	16/12	9	-	1100,25
J20381814	18/14	8	-	1249,50

U = bøjeradius i mm

Luftslange 100m sort PE (POLYETHYLEN)



Varenr.	Ø/ø	BAR	U	DKK
J20310402	4/2	21	18	230,00
J20310604	6/4	13	28	246,50
J20310806	8/6	9	40	358,75
J20311008	10/8	7	57	439,75
J20311210	12/10	6	75	539,75
J20311512	15/12	7	-	793,25
J20311612	16/12	9	-	1100,25
J20311814	18/14	8	-	1249,50

U = bøjeradius i mm

Luftslange 100m gul PE (POLYETHYLEN)

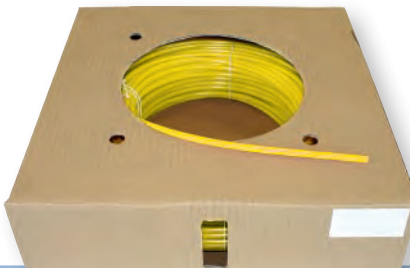

Varenr.	Ø/ø	BAR	U	DKK
J20350402	4/2	21	18	230,00
J20350604	6/4	13	28	246,50
J20350806	8/6	9	40	358,75
J20351008	10/8	7	57	439,75
J20351210	12/10	6	75	539,75
J20351612	16/12	9	-	1100,25
J20351814	18/14	8	-	1249,50

U = bøjeradius i mm

Luftslange 100m rød PE (POLYETHYLEN)

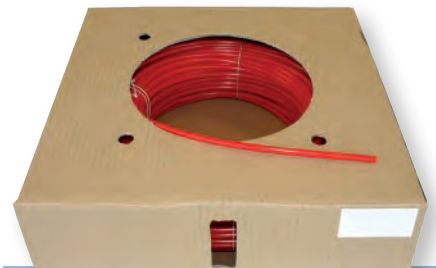

Varenr.	Ø/ø	BAR	U	DKK
J20370402	4/2	21	18	230,00
J20370604	6/4	13	28	246,50
J20370806	8/6	9	40	358,75
J20371008	10/8	7	57	439,75
J20371210	12/10	6	75	539,75
J20371612	16/12	9	-	1100,25
J20371814	18/14	8	-	1249,50

U = bøjeradius i mm

Max. arbejdstryk beregning

Max. arbejdstryk beregnes vha. følgende formel:

$$\text{Max. arbejdstryk} = \frac{2s \times R}{\varnothing}$$

- 2s = 2 x godstykkelse
- Ø = beregningsdiameter (indv. Ø + (1 x godstykkelse))
- R = beregningskoefficient (materialestyrke)

Koefficient for vore slanger ved 23°C:

PA = 50
PE = 24
PU = 25

Max. arbejdstryk eksempel

PA-slange Ø10x8
Koefficient: 50

$$\text{Max. arbejdstryk} = \frac{4 \times 50}{9} = 22,22 \text{ ATM (22,5 bar)}$$

Omregningsfaktor: 1 ATM = 1,01325 bar

Beregningerne er kun vejledende, da de påvirkes af mange faktorer afhængigt af den aktuelle brug.

POLYETHYLENSLANGE (PE)

Fleksibel slange, anvendes i regulerings-, måle-, styre- og laboratorieteknik samt produktion bla. pga. lav vægt og slagfasthed. PE slange er bestandig mod: syre og saltopløsninger. Tåler ikke benzin. Temperatur fra -10° til +60°C.

Trykangivelser er ved 20°C.

Velegnet til push-in og kompressionsfittings.

Luftslange 25m neutral PE (POLYETHYLEN)



Leveres uden kasse

Varenr.	Ø/ø	BAR	U	DKK
J20100402	4/2	21	18	94,20
J20100604	6/4	13	28	123,75
J20100806	8/6	9	40	163,00
J20101008	10/8	7	57	211,00
J20101210	12/10	6	75	265,50
J20101512	15/12	7	-	264,50
J20101612	16/12	9	-	306,25
J20101814	18/14	8	-	624,75

U = bøjeradius i mm

Luftslange 25m blå PE (POLYETHYLEN)



Leveres uden kasse

Varenr.	Ø/ø	BAR	U	DKK
J20140402	4/2	21	18	94,20
J20140604	6/4	13	28	123,75
J20140806	8/6	9	40	163,00
J20141008	10/8	7	57	211,00
J20141210	12/10	6	75	265,50
J20141512	15/12	7	-	264,50
J20141612	16/12	9	-	306,25
J20141814	18/14	8	-	624,75

U = bøjeradius i mm

Luftslange 25m grøn PE (POLYETHYLEN)



Leveres uden kasse

Varenr.	Ø/ø	BAR	U	DKK
J20180402	4/2	21	18	94,20
J20180604	6/4	13	28	123,75
J20180806	8/6	9	40	163,00
J20181008	10/8	7	57	211,00
J20181210	12/10	6	75	265,50
J20181512	15/12	7	-	288,00
J20181612	16/12	9	-	306,25
J20181814	18/14	8	-	624,75

U = bøjeradius i mm

Luftslange 25m sort PE (POLYETHYLEN)



Leveres uden kasse

Varenr.	Ø/ø	BAR	U	DKK
J20110402	4/2	21	18	94,20
J20110604	6/4	13	28	123,75
J20110806	8/6	9	40	163,00
J20111008	10/8	7	57	211,00
J20111210	12/10	6	75	265,50
J20111512	15/12	7	-	264,50
J20111612	16/12	9	-	306,25
J20111814	18/14	8	-	624,75

U = bøjeradius i mm

Luftslange 25m gul PE (POLYETHYLEN)



Leveres uden kasse

Varenr.	Ø/ø	BAR	U	DKK
J20150402	4/2	21	18	94,20
J20150604	6/4	13	28	123,75
J20150806	8/6	9	40	163,00
J20151008	10/8	7	57	211,00
J20151210	12/10	6	75	265,50
J20151512	15/12	7	-	288,00
J20151612	16/12	9	-	306,25
J20151814	18/14	8	-	624,75

U = bøjeradius i mm

Luftslange 25m rød PE (POLYETHYLEN)



Leveres uden kasse

Varenr.	Ø/ø	BAR	U	DKK
J20170402	4/2	21	18	94,20
J20170604	6/4	13	28	123,75
J20170806	8/6	9	40	163,00
J20171008	10/8	7	57	211,00
J20171210	12/10	6	75	265,50
J20171512	15/12	7	-	288,00
J20171612	16/12	9	-	306,25
J20171814	18/14	8	-	624,75

U = bøjeradius i mm

Max. arbejdsstryk beregning

Max. arbejdsstryk beregnes vha. følgende formel:

$$\text{Max. arbejdsstryk} = \frac{2s \times R}{\emptyset}$$

- 2s = 2 x godstykkelse
- Ø = beregningsdiameter (indv. Ø + (1 x godstykkelse))
- R = beregningskoefficient (materialestyrke)

Koefficient for vore slanger ved 23°C:

PA = 50

PE = 24

PU = 25

Max. arbejdsstryk eksempel

PA-slange Ø10x8

Koefficient: 50

$$\text{Max. arbejdsstryk} = \frac{4 \times 50}{9} = 22,22 \text{ ATM (22,5 bar)}$$

Omregningsfaktor: 1 ATM = 1,01325 bar

Beregningerne er kun vejledende, da de påvirkes af mange faktorer afhængigt af den aktuelle brug.

POLYETHYLENSLANGE (PE)

Fleksibel slange, anvendes i regulerings-, måle-, styre- og laboratorietechnik samt produktion bla. pga. lav vægt og slagfasthed. PE slange er bestandig mod: syre og saltopløsninger. Tåler ikke benzin. Temperatur fra -10° til +60°C.

Trykangivelser er ved 20°C.

Velegnet til push-in og kompressionsfittings.

Luftslange 100m neutral PU (POLYURETHAN)

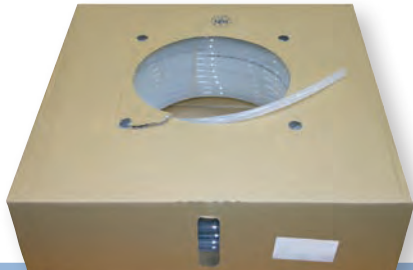

Varenr.	Ø/ø	BAR	U	DKK
J30300402	4/2	22	13	545,00
J30300604	6/4	13	20	879,25
J30300806	8/6	10	30	1257,75
J30301008	10/8	7	40	1634,75
J30301210	12/9	10	52	1962,25

U = bøjeradius i mm

Luftslange 100m sort PU (POLYURETHAN)



Varenr.	Ø/ø	BAR	U	DKK
J30310316	3/1,5	-	-	438,75
J30310402	4/2	22	13	545,00
J30310604	6/4	13	20	879,25
J30310806	8/6	10	30	1257,75
J30311008	10/8	7	40	1634,75
J30311210	12/9	10	52	1962,25

U = bøjeradius i mm

Luftslange 100m blå PU (POLYURETHAN)

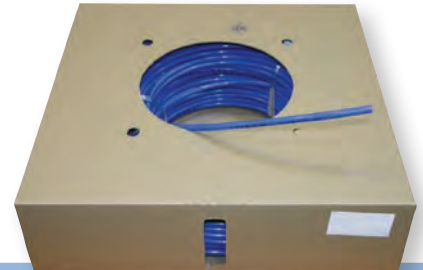

Varenr.	Ø/ø	BAR	U	DKK
J30340316	3/1,5	-	-	438,75
J30340402	4/2	22	13	545,00
J30340604	6/4	13	20	879,25
J30340806	8/6	10	30	1257,75
J30341008	10/8	7	40	1634,75
J30341210	12/9	10	52	1962,25

U = bøjeradius i mm

Luftslange 25m neutral PU (POLYURETHAN)



Leveres uden kasse

Varenr.	Ø/ø	BAR	U	DKK
J30100402	4/2	22	13	182,50
J30100604	6/4	13	20	293,25
J30100806	8/6	10	30	418,25
J30101008	10/8	7	40	545,00
J30101210	12/9	10	52	654,50

U = bøjeradius i mm

Luftslange 25m sort PU (POLYURETHAN)



Leveres uden kasse

Varenr.	Ø/ø	BAR	U	DKK
J30110402	4/2	22	13	182,50
J30110604	6/4	13	20	293,25
J30110806	8/6	10	30	418,25
J30111008	10/8	7	40	545,00
J30111210	12/9	10	52	654,50

U = bøjeradius i mm

Luftslange 25m blå PU (POLYURETHAN)



Leveres uden kasse

Varenr.	Ø/ø	BAR	U	DKK
J30140402	4/2	22	13	182,50
J30140604	6/4	13	20	293,25
J30140806	8/6	10	30	418,25
J30141008	10/8	7	40	545,00
J30141210	12/9	10	52	654,50

U = bøjeradius i mm

Max. arbejdstryk beregning

Max. arbejdstryk beregnes vha. følgende formel:

$$\text{Max. arbejdstryk} = \frac{2s \times R}{\emptyset}$$

- 2s = 2 x godstykkelse
- Ø = beregningsdiameter (indv. Ø + (1 x godstykkelse))
- R = beregningskoefficient (materialestyrke)

Koefficient for vore slanger ved 23°C:

PA = 50

PE = 24

PU = 25

Max. arbejdstryk eksempel

PA-slange Ø10x8

Koefficient: 50

$$\text{Max. arbejdstryk} = \frac{4 \times 50}{9} = 22,22 \text{ ATM (22,5 bar)}$$

Omregningsfaktor: 1 ATM = 1,01325 bar

Beregningerne er kun vejledende, da de påvirkes af mange faktorer afhængigt af den aktuelle brug.

POLYURETHANSLANGE (PU)

Meget fleksibel slange, særdeles anvendelig til pneumatik og robotteknik. Leveres som standard i shore A 95/98.

PU slange er bestandig mod: de fleste smøreløser, ilt og ozon.

Temperatur fra -20° til +75°C.

Trykangivelser er ved 20°C.

Velegnet til Push-in og kompressionsfittings og slangenipler.

Chemische Beständigkeit von PA, PE und PUR

Alle Angaben, auch die der Drücke, entsprechen Erfahrungs- und Testwerten. Eine Garantie kann daraus nicht abgeleitet werden.

Reagenzien	Konzentrations- treibmittel in %	PA 6	PA 11 u. 12		Nieder- druck PE	Nieder- druck PU	Reagenzien	Konzentrations- treibmittel in %	PA 6	PA 11 u. 12		Nieder- druck PE	Nieder- druck PU
			hart und weich	Hoch- druck						hart und weich	Hoch- druck		
Acetaldehyd	40	±	+	+	+		Säuren						
Acetamid	50	+	+	+	+		Ameisensäure	85	-	+	+	+	
Acrylnitril	100	±	+	-	+		Ameisensäure	40	-	-	-	-	
Allylalkohol	100	±	±	+	+		Ameisensäure	10	+	+	+	+	
Aluminiumsulfat	10	+	+	+	+	+	Borsäure	10	+	+	+	+	
Aluminiumchlorid	10	+	+	+	+	+	Chromsäure	10	-	+	+	+	
Ammonchlorid	10	+	+	+	+	+	Chromsäure	1	+	+	+	+	
Anilin	100	-	+	+	+	+	Citronensäure	10	-	+	+	+	
Benzaldehyd	100	-	-	+	+	+	Essigsäure	80	-	+	+	+	
Bleichlauge 0,1% akt. Chlor		-	-	±	±	±	Essigsäure	40	-	-	+	+	
Calciumchlorid, wäßrig	10	+	+	+	+	+	Essigsäure	10	+	+	+	+	
Calciumchlorid, alkoholisch	20	-	-	-	-	-	Flußsäure	40	+	+	+	+	
Chlorgas	100	-	-	-	-	±	Milchsäure	10	±	+	+	+	
Chlorwasser		-	-	-	-	±	Ölsäure, konz.		+	+	+	+	
Dieselöl	100	+	+	+	+	+	Oxalsäure	10	-	+	+	+	
Dibutylphthalat	100	+	+	±	±	+	Phosphorsäure, konz.		-	+	+	+	
Diocetylphthalat	100	+	+	+	+	+	Phosphorsäure	10	-	+	+	+	
Dioxan	100	+	+	+	+	+	Salpetersäure, konz.		-	+	+	+	
Eisenchlorid	10	+	+	+	+	+	Salpetersäure	10	-	+	+	+	
Formaldehyd, wäßrig		±	±	±	±	±	Salzsäure	10	-	+	+	+	
Freon 12 (flüssig)		+	+	±	±	±	Salzsäure	2	-	+	+	+	
Furfuröl		±	±	±	±	±	Schwefelsäure	98	-	+	+	+	
Glycerin		+	+	+	+	+	Schwefelsäure	40	-	+	+	+	
Harnstoff, wäßrig		+	+	+	+	+	Schwefelsäure	10	-	+	+	+	
Hexan	100	+	+	+	+	+	Schwefelsäure	2	-	+	+	+	
Heptan	100	+	+	+	+	+							
Jodtinktur		-	-	+	+	-	Basen						
Jod-Jodkaliumlösung	3	-	-	+	+	-	Ammoniak	10	+	+	+	+	
Kaliumbichromat	5	±	±	+	+	+	Kallauge, wäßrig	50	+	+	+	+	
Kaliumnitrat	10	+	±	+	+	+	Kallauge, wäßrig	10	+	+	+	+	
Kaliumpermanganat	1	-	-	+	+	+	Natronlauge, wäßrig	50	+	+	+	+	
Kupfersulfat	10	±	+	+	+	+	Natronlauge, wäßrig	10	+	+	+	+	
Magnesiumchlorid, wäßrig		+	+	+	+	+							
Mineralöl		+	+	+	+	+	Org. Lösungsmittel						
Natriumbisulfid	10	+	+	+	+	+	Aceton	100	+	+	±	+	
Natriumcarbonat	10	+	+	+	+	+	Anon	100	+	+	±	+	
Natriumchlorid	10	+	+	+	+	+	Äthanol	96	+	+	±	+	
Natriumsulfat	10	+	±	±	±	±	Äthylacetat	100	+	+	±	+	
Ozon		-	-	±	±	±	Äthyläther	100	+	+	±	+	
Phenol (geschmolzen)	100	-	-	-	+	+	Äthylchlorid	100	+	±	±	±	
Phenol (wäßrig)		-	-	±	±	±	Äthylendiamin	100	+	+	±	±	
Quecksilber		+	+	+	+	+	Benzin	100	+	+	±	±	
Quecksilberchlorid, wäßrig	5	-	-	+	+	+	Benzol	100	+	+	±	±	
Schwefelwasserstoff, wäßrig		+	+	+	+	+	Benzol	100	+	+	±	±	
Schwefelkohlenstoff		+	+	-	±	±	Benzylalkohol	100	-	+	+	±	
Seewasser		+	+	+	+	+	Butanol	100	+	+	+	±	
Seifenlösung		+	+	+	+	+	Butylacetat	100	+	+	+	±	
Styrol		+	+	+	+	+	Chloroform	100	-	+	-	±	
Talg		+	+	+	+	+	Chlorbenzol	100	+	±	±	±	
Thionylchlorid		-	-	-	-	-	Cyclohexanol	100	-	+	±	±	
Tetraöl		+	+	+	+	+	Dekalin	100	-	+	±	±	
Wasser, kalt		+	+	+	+	+	Isopropylalkohol		-	+	±	±	
Wasser, heiß		+	+	+	+	+	Methanol		-	+	±	±	
Wasserstoffperoxid	0,5	-	+	+	+	+	Methylacetat	100	+	+	±	±	
Wasserstoffperoxid	1,0	-	+	±	±	±	Methyläthylketon		-	+	±	±	
Wasserstoffperoxid	3,0	-	+	+	+	+	Methylenchlorid		-	+	±	±	
Wasserstoffperoxid	10,0	-	+	+	+	+	Nitrobenzol	100	±	+	±	±	
Wasserstoffperoxid	30,0	-	+	+	+	+	Petroleum		-	+	±	±	
Wachs, geschmolzen		+	+	+	+	+	Pyridin		+	+	±	±	
Wein		+	±	±	±	±	Tetrachlorkoheinstoff		+	±	±	±	
Weinbrand		+	+	+	+	+	Tetrahydrofuran		+	+	±	±	
Zinkchlorid	10,0						Tetralin		+	+	±	±	
							Thionalchlorid		+	-	-	-	
							Trichloräthylen		+	-	-	-	
							Toluol		+	+	±	±	
							Xylol		+	+	±	±	
							Schwefelkohlenstoff		+	-	-	-	

Erklärung: + beständig ± bedingt beständig = unbeständig

SLANGER TIL TRYKLUF



NB! Der er afkortningstillæg på kr. 50 på alle slanger, der leveres afskåret.

Afklippede slanger tages ikke retur!

Slangestørrelser angives typisk i mm og svarer til følgende tommemål:

4mm = 1/8"
5mm = 3/16"

6mm = 1/4"
8mm = 5/16"
10mm = 3/8"
12mm = 1/2"
16mm = 5/8"
19mm = 3/4"
25mm = 1"
32mm = 1 1/4"
38mm = 1 1/2"

52mm = 2"
62mm = 2 1/2"
77mm = 3"
102mm = 4"
127mm = 5"
153mm = 6"

JWL slange blød armeret PVC (POLYVINYLCHLORID)



Med JWL 520 kobling+nippel, max 15bar

Varenr.	ø × Ø	Type	L	DKK
JT81-1-5	6,3 × 11	520	5m	471,00
JT81-1-10	6,3 × 11	520	10m	610,25
JT81-1-15	6,3 × 11	520	15m	831,25
JT81-1-20	6,3 × 11	520	20m	987,50
JT81-2-5	9 × 14,5	520	5m	547,50
JT81-2-10	9 × 14,5	520	10m	751,75
JT81-2-15	9 × 14,5	520	15m	1049,75
JT81-2-20	9 × 14,5	520	20m	1237,25

JWL spiralslange PUR (POLYURETHAN)



Med JWL 530 kobling+nippel, max 10bar

Varenr.	ø × Ø	Type	L	DKK
JT80-1-1	4 × 6	530	1m	715,75
JT80-2-1	5 × 8	530	1m	800,25
JT80-2-2	5 × 8	530	2m	833,75
JT80-2-4	5 × 8	530	4m	949,00
JT80-2-6	5 × 8	530	6m	1033,25
JT80-2-8	5 × 8	530	8m	1197,00
JT80-3-2	6,5 × 10	530	2m	924,75
JT80-3-4	6,5 × 10	530	4m	1014,00
JT80-3-6	6,5 × 10	530	6m	1282,50
JT80-3-8	6,5 × 10	530	8m	1424,50
JT80-4-2	8 × 12	530	2m	1085,75
JT80-4-4	8 × 12	530	4m	1282,50
JT80-4-6	8 × 12	530	6m	1558,50
JT80-4-8	8 × 12	530	8m	1919,00

Spiralslange PA (POLYAMID)



Max 44 bar

Varenr.	Ø/ø	L	ind/udv	DKK
J19-1	4/2	10m	30-38	197,25
J19-2	4/2,5	15m	30-38	228,50
J19-4	6/4	10m	50-62	254,00
J19-5	6/4	15m	50-62	296,75
J19-6	6/4	30m	50-62	460,00
J19-7	8/6	10m	60-76	291,00
J19-8	8/6	15m	60-76	369,00
J19-9	8/6	30m	60-76	603,00
J19-12	10/8	30m	80-100	744,00

Sælges kun i fuld længde.

Spiralslange max 27 bar PA (POLYAMID)

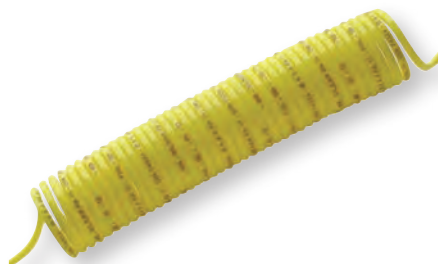

Varenr.	Ø/ø	L	diam.	DKK
J40-1	12/8	3,5m	80	325,00
J40-2	12/8	4,7m	80	379,25
J40-3	12/9	3,5m	100	325,00
J40-4	12/9	4,7m	100	312,75
J40-5	12/9	5,7m	100	355,75

Sælges kun i fuld længde.

Spiralslange max 12 bar

PU (POLYURETHAN)

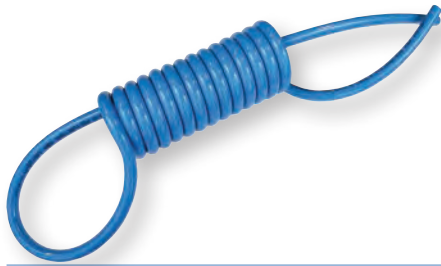

Varenr.	Ø/ø	L	diam.	DKK
J41-1	4/2,5	1,5m	18	121,00
J41-2	4/2,5	3m	28	157,75
J41-3	6/4	1,5m	32	135,00
J41-4	6/4	3m	32	164,50
J41-5	8/5,5	2m	41	179,75
J41-6	8/5,5	4m	41	265,50
J41-7	8/5,5	6m	41	340,50
J41-8	8/5,5	8m	41	415,50
J41-9	8/5,5	10m	41	464,25
J41-10	10/6,5	2,5m	60	202,00
J41-11	10/6,5	4m	60	310,75
J41-12	10/6,5	6m	60	419,00
J41-13	10/6,5	8m	60	509,00
J41-14	10/6,5	10m	60	587,25
J41-15	12/8	2m	74	228,50
J41-16	12/8	3m	74	363,00
J41-17	12/8	6m	74	499,75
J41-18	12/8	8m	74	615,25
J41-19	12/8	10m	74	740,00
J41-20	12/8	12m	74	875,50

Sælges kun i fuld længde.

Slangenippel m. fjeder

MESSING - BSPT

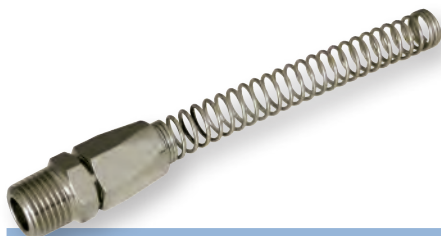

Varenr.	Ø/ø × BSPT	DKK
J20-1	6/4 × 1/8"	29,60
J20-2	6/4 × 1/4"	31,30
J20-3	6/4 × 3/8"	43,50
J20-4	6/4 × 1/2"	50,85
J20-5	8/6 × 1/8"	34,05
J20-6	8/6 × 1/4"	34,95
J20-7	8/6 × 3/8"	43,25
J20-8	10/8 × 1/4"	42,05
J20-9	10/8 × 3/8"	48,90
J20-10	10/8 × 1/2"	64,95

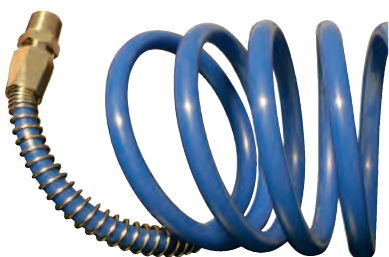

Profilair slange

PVC (POLYVINYLCHLORID)



Sort fleksibel PVC slange med polyester forstærkning. UV bestandig og meget slidstærk. Bruges til trykluft.

-15° til +60°C

Varenr.	ø/Ø	bar 20°C	L	DKK
JA28-0612	6/12	20	50m	1118,75
JA28-0814	8/14	20	50m	1203,25
JA28-1016	10/16	20	50m	1369,00
JA28-1320	12,7/20	20	50m	1842,75
JA28-1624	16/24	20	50m	2346,50
JA28-1927	19/27	20	50m	2571,00

Sælges kun i fuld længde.

Trykluftslange

PVC (POLYVINYLCHLORID)



Sort forstærket PVC-nitril slange til trykluft, særdeles smidig, UV-bestandig, olieresistent og slidbestandig.

Varenr.	ø/Ø	bar 20°C	L	DKK
JA4-0612	6/12	20	50m	789,25
JA4-0814	8/14	20	50m	882,00
JA4-1017	10/17	20	50m	971,00
JA4-1221	12,7/21,5	20	50m	1578,00

Sælges kun i fuld længde.

Trykluftslange

EPDM



Indvendig EPDM glat gummi. Armering: 1 lag tekstilvæv. Udvendig EPDM sort glat gummi. Særdeles vejr- og ældningsbestandig.

-40° til +100°C (JA16-9 +60°C)

Varenr.	ø/Ø	bar 20°C	L	DKK / m
JA16-1	6,3/13	10	50m	34,40
JA16-2	8/15	10	50m	37,25
JA16-3	10/16	10	50m	40,40
JA16-4	13/20	10	50m	46,35
JA16-5	16/23	10	50m	53,75
JA16-6	19/27	10	50m	60,35
JA16-7	25/34	8,5	50m	83,80
JA16-9	40/54	10	20m	216,50

Afskæres mellem 1 - 5m, ellers fuld længde.

Mini slange lavtryk

PVC (POLYVINYLCHLORID)

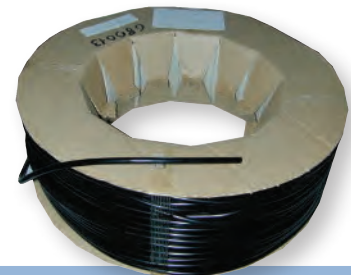

Varenr.	ø/Ø	L	DKK
JA11-5	3/5	350m	748,75
JA11-7	5/8	130m	792,25

Sælges kun i fuld længde.

Slange

GUMMI - BSPT



Alle størrelser, undtagen J12-10, leveres monteret med 1/4" fittings.
Til olie, luft og vand. Sælges kun i hele ruller.

Varenr.	ø/Ø	bar 20°C	L	DKK
J12-1	6/12	17	7,5m	182,25 α
J12-3	6/12	17	30m	602,00 α
J12-7	12/19	10	7,5m	331,00 α

α = så længe lager haves

Slange gnistsikker

PA (POLYAMID)



-40° til +80°C

Varenr.	ø×Ø×Ø	bar 20°C	L	DKK
J46-1	2,5×4×6,5	38	25m	904,25
J46-2	4×6×8,5	33	25m	1294,75
J46-3	6×8×10,5	24	25m	2884,00
J46-4	7,5×10×12	23	25m	2495,75
J46-5	9×12×14,5	24	25m	3102,50

Sælges kun i fuld længde.

Maluform slange

PE (POLYETHYLEN) / ALUMINIUM



Aluminium foring gør, at slangen kan bukkes og drejes og så beholder formen.
Velegnet til brug med Push-in fittings.

-30° til +70°C

Varenr.	Ø	bar 20°C	L	DKK
JM1-1	6	25	25m	689,50
JM1-2	8	25	25m	897,75
JM1-3	10	20	25m	1403,00
JM1-4	12	25	25m	2122,00

Sælges kun i fuld længde.

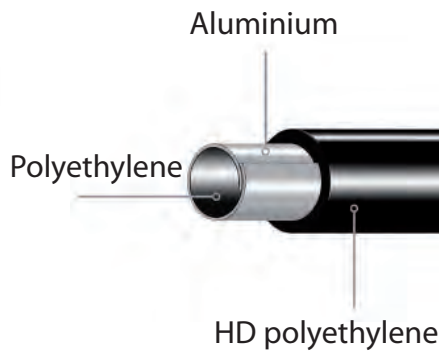

SLANGER TIL VÆSKE/VAND



NB! Der er afkortningstillæg på kr. 50 på alle slanger, der leveres afskåret.

Afklippe slanger tages ikke retur!

Slangestørrelser angives typisk i mm og svarer til følgende tommemål:

4mm = 1/8"
5mm = 3/16"

6mm = 1/4"
8mm = 5/16"
10mm = 3/8"
12mm = 1/2"
16mm = 5/8"
19mm = 3/4"
25mm = 1"
32mm = 1 1/4"
38mm = 1 1/2"

52mm = 2"
62mm = 2 1/2"
77mm = 3"
102mm = 4"
127mm = 5"
153mm = 6"

Filclair N slange neutral

PVC (POLYVINYLCHLORID)

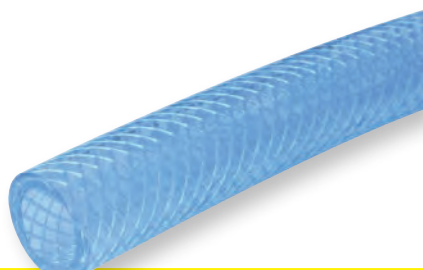

-15° til +60°C

Varenr.	ø/Ø	bar 20°C	L	DKK
J70200804	4/8	10	50m	488,50
J70201206	6/12	15	50m	663,00
J70201408	8/14	15	50m	719,00
J70201610	10/16	15	50m	808,25
J70201913	13/19	10	50m	1005,25
J70202216	16/22	10	50m	1278,25
J70202619	19/26	10	50m	1709,00
J70203325	25/33	10	50m	2160,00
J70204232	32/42	12	50m	4080,00
J70204838	38/48	10	50m	4596,00
J70206050	50/60	8	50m	5074,00

Sælges kun i fuld længde.

Filclair AL slange blå

PVC (POLYVINYLCHLORID)

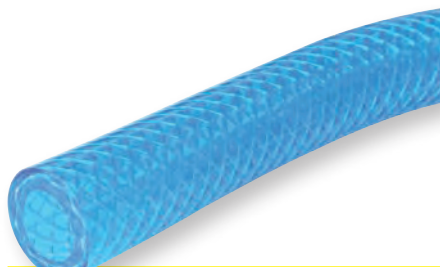

-15° til +60°C

Varenr.	ø/Ø	bar 20°C	L	DKK
J70241206	6/12	15	50m	663,00
J70241408	8/14	15	50m	719,00
J70241610	10/16	15	50m	808,25
J70241913	13/19	10	50m	1068,25

Sælges kun i fuld længde.

Filclair AL slange rød

PVC (POLYVINYLCHLORID)



-15° til +60°C

Varenr.	ø/Ø	bar 20°C	L	DKK
J70231206	6/12	15	50m	663,00
J70231408	8/14	15	50m	719,00
J70231610	10/16	15	50m	808,25
J70231913	13/19	10	50m	1068,25

Sælges kun i fuld længde.

Hobbyslange gul

PVC (POLYVINYLCHLORID)

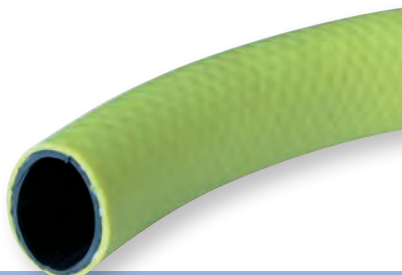

Varenr.	ø/Ø	bar 20°C	L	DKK
JA1-1216	12,5/16,5	8	25m	177,00
JA1-1519	15/19	8	25m	213,75
JA1-1923	19/23,5	8	25m	428,75
JA1-2531	25/31	8	25m	627,50

Sælges kun i fuld længde.

Hobbyslange grøn

PVC (POLYVINYLCHLORID)

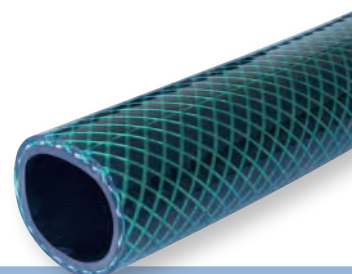

Varenr.	ø/Ø	bar 20°C	L	DKK
JA1-3241-50	32/41	8	50m	1621,25

Sælges kun i fuld længde.

Narcis ATH slange

PVC (POLYVINYLCHLORID)

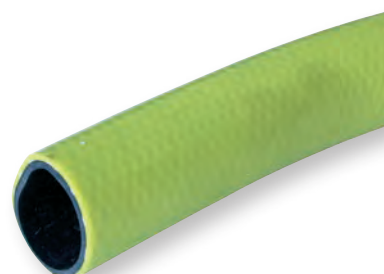

Suveræn vandslange, blød og føjelig og strikket, så den modvirker at blive vredet. Sort indvendig. UV bestandig gul PVC yderst.

Varenr.	ø/Ø	bar 20°C	L	DKK
JA2-1216	12,5/16,5	10	25m	229,00
JA2-1519	15/19,5	10	25m	500,75
JA2-1924	19/24,5	10	25m	602,00
JA2-2531	25/31,5	10	25m	844,75

Sælges kun i fuld længde.

Cristal slange PVC (POLYVINYLCHLORID)

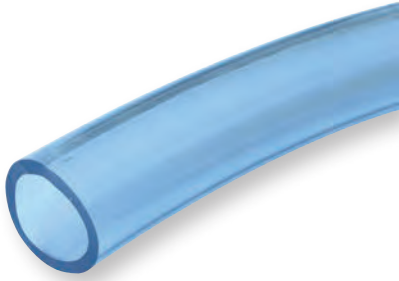

Klar PVC slange, uforstærket, brugbar til utallige trykløse formål.

-15° til +60°C				
Varenr.	ø/Ø	bar 20°C	L	DKK
JA3-0204-100	2/4	0	100m	407,50
JA3-0305-100	3/5	0	100m	465,75
JA3-0406-100	4/6	0	100m	477,50
JA3-0608-50	6/8	0	50m	273,75
JA3-0608-100	6/8	0	100m	547,25
JA3-0609-100	6/9	0	100m	606,00
JA3-0810	8/10	0	50m	409,75
JA3-0812	8/12	0	50m	737,75
JA3-1013	10/13	0	50m	545,00
JA3-1216	12/16	0	50m	833,50
JA3-1620	16/20	0	50m	1087,75
JA3-1924	19/24	0	50m	1343,25
JA3-2531	25/31	0	50m	2402,00
JA3-3240	32/40	0	25m	2174,50
JA3-3848	38/48	0	25m	3025,25
JA3-5060	50/60	0	25m	4720,50
JA3-6070	60/70	0	25m	5565,25

Sælges kun i fuld længde.

Christal slange grøn PVC (POLYVINYLCHLORID)

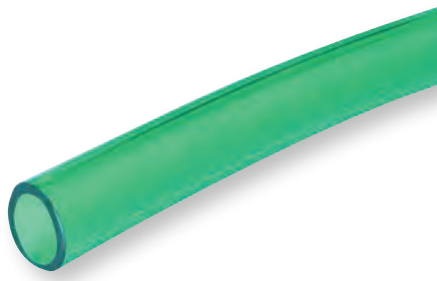

Christal grøn er en fleksibel PVC slange. Glat ind- og udvendig. Beregnet til akvarium og lettere industri.

-15° til +60°C				
Varenr.	ø/Ø	bar 20°C	L	DKK
JA32-0406	4/6	0	100m	562,25
JA32-0608	6/8	0	100m	618,75
JA32-0912	9/12	0	50m	615,25
JA32-1216	12/16	0	50m	921,50
JA32-1622	16/22	0	50m	1509,00
JA32-1924	19/24	0	50m	1621,25
JA32-2430	24/30	0	25m	1214,50
JA32-3037	30/37	0	25m	1841,75
JA32-3848	38/48	0	25m	3141,50
JA32-5060	50/60	0	25m	4830,75

Sælges kun i fuld længde.

Profiltres 40 slange PVC (POLYVINYLCHLORID)



Lyseblå fleksibel PVC slange med polyester forstærkning. UV bestandig og meget slidstærk. Kan bruges til trykluft og sprøjtemaskiner i bl.a. landbruget.

-15° til +60°C, max 40bar				
Varenr.	ø/Ø	bar 20°C	L	DKK
JA6-0612	6/12,5	40	50m	850,25
JA6-0814	8/14,5	40	50m	971,00
JA6-0916	9/16	40	50m	1032,25
JA6-1017	10/17	40	50m	1094,00
JA6-1220	12/20	40	50m	1549,25
JA6-1624	16/24	40	50m	1984,00
JA6-1928	19/28	40	50m	2286,75
JA6-2535	25/35	40	50m	3399,00

Sælges kun i fuld længde.

Profiltres 80 slange PVC (POLYVINYLCHLORID)



Mørkeblå fleksibel PVC slange med kevlar forstærkning. UV bestandig og meget slidstærk. Kan bruges til trykluft og sprøjtemaskiner i bl.a. landbruget.

-15° til +60°C, max 80bar				
Varenr.	ø/Ø	bar 20°C	L	DKK
JA26-0816	8/16	80	50m	2736,75
JA26-0918	9/18	80	50m	3076,75
JA26-1019	10/19	80	50m	3267,25
JA26-1221	12/21	80	50m	4076,75
JA26-1626	16/26	80	50m	6031,75
JA26-1930	19/30	80	50m	7455,25

Sælges kun i fuld længde.

Slange til kølevand EPDM

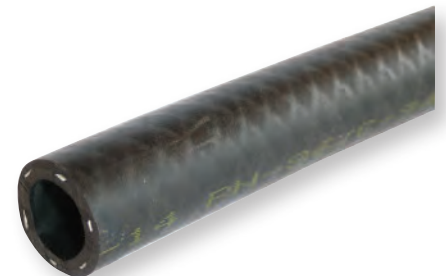

Indvendig EPDM glat gummi. Armering: 1 lag polyestervæv. Udvendig EPDM sort glat gummi. Særligt vejr- og ældningsbestandig.

-40° til +100°C				
Varenr.	ø/Ø	bar 20°C	L	DKK / m
JA17-3	10/17	10	50m	32,40
JA17-4	13/20	10	50m	41,80
JA17-5	16/23	10	50m	66,60
JA17-6	19/27	10	50m	97,70
JA17-7	25/34	10	50m	142,00

Afskæres mellem 1 - 5m, ellers fuld længde.

SLANGER TIL VAKUUM OG TRYK



NB! Der er afkortningstillæg på kr. 50 på alle slanger, der leveres afskåret.

Afklippede slanger tages ikke retur!

Slangestørrelser angives typisk i mm og svarer til følgende tommemål:

4mm = 1/8"
5mm = 3/16"

6mm = 1/4"
8mm = 5/16"
10mm = 3/8"
12mm = 1/2"
16mm = 5/8"
19mm = 3/4"
25mm = 1"
32mm = 1 1/4"
38mm = 1 1/2"

52mm = 2"
62mm = 2 1/2"
77mm = 3"
102mm = 4"
127mm = 5"
153mm = 6"

Azur slange blå

PVC (POLYVINYLCHLORID)



Fleksibel PVC slange med hård PVC spiral. Anvendes til sugning af væske, vanding uden tryk, afløb.

-10° til +60°C

Varenr.	ø/Ø	VAC/BAR	L	DKK / m
JA10-16B	16/21	-0,6 5	25m	25,40
JA10-20B	20/24,8	-0,6 5	25m	28,10
JA10-25B	25/29,8	-0,6 5	25m	31,30
JA10-32B	32/37,2	-0,6 5	25m	36,40
JA10-38B	38/44	-0,6 5	25m	45,20
JA10-50B	50/57,2	-0,6 5	25m	64,95
JA10-63B	63/70,4	-0,6 5	25m	77,00
JA10-76B	75/83,2	-0,6 4	25m	102,75
JA10-80B	80/89	-0,5 4	25m	122,25
JA10-100B	100/110,8	-0,5 3	25m	165,00
JA10-125B	125/137,4	-0,5 3	25m	262,50
JA10-150B	150/162,4	-0,2 2	20m	351,25
JA10-160B	160/172,4	-0,2 2	20m	364,50

Afskæres mellem 1 - 5m, ellers fuld længde.

Azur slange grøn

PVC (POLYVINYLCHLORID)



Fleksibel PVC slange med hård PVC spiral. Anvendes til sugning af væske, vanding uden tryk, afløb.

-10° til +60°C

Varenr.	ø/Ø	VAC/BAR	L	DKK / m
JA10-16G	16/20,7	-0,6 5	50m	24,65
JA10-20G	20/24,5	-0,6 5	50m	28,10
JA10-25G	25/29,4	-0,6 5	50m	31,30
JA10-32G	32/36,8	-0,6 5	50m	36,40
JA10-38G	38/43,4	-0,6 5	50m	45,20
JA10-50G	50/56,6	-0,6 5	50m	64,95

Afskæres mellem 1 - 5m, ellers 50m.

Alfacier slange

PVC (POLYVINYLCHLORID)



Blød PVC slange med ståls spiral. Yderst bøjelig. Velegnet til ansugning eller udblæsning af væsker.

-10° til +60°C

Varenr.	ø/Ø	VAC/BAR	L	DKK / m
JA14-10	10/16	-0,85 5	60m	20,00
JA14-12	12/18	-0,85 5	60m	21,95
JA14-16	16/23	-0,85 5	60m	32,40
JA14-20	20/27	-0,85 4	60m	38,95
JA14-25	25/33	-0,85 4	60m	60,35
JA14-32	32/41	-0,85 4	60m	76,45
JA14-38	38/47	-0,85 4	30m	93,40
JA14-40	40/50	-0,85 4	30m	111,50
JA14-50	50/61	-0,8 3	30m	158,25
JA14-63	63/78	-0,8 3	30m	231,75
JA14-80	80/97	-0,7 2	20m	329,25
JA14-102	102/119	-0,7 2	20m	473,75

Afskæres mellem 1 - 5m, ellers fuld længde.

Alfavac slange 10m

PU-L (POLYURETHAN)

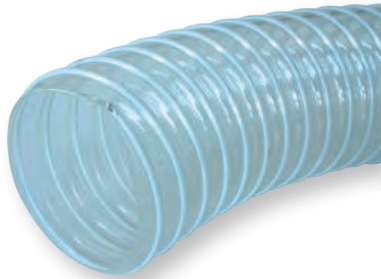

Lamineret polyurethan slange med fjederstål spiral. Anvendes til sugning og transport af afslibningsprodukter.

-30° til +100°C

Varenr.	∅	VAC/BAR	L	DKK / m
JA15-60	60	-0,3 3	10m	212,25
JA15-65	63	-0,3 3	10m	230,50
JA15-70	70	-0,3 3	10m	249,75
JA15-75	76	-0,3 3	10m	272,50
JA15-80	80	-0,2 2	10m	277,25
JA15-90	90	-0,2 2	10m	312,00
JA15-100	102	-0,2 2	10m	357,50
JA15-110	110	-0,2 2	10m	459,50
JA15-120	120	-0,2 2	10m	493,50
JA15-125	127	-0,2 2	10m	522,00
JA15-130	130	-0,1 1	10m	534,00
JA15-140	140	-0,1 1	10m	576,75
JA15-150	152	-0,1 1	10m	627,50
JA15-160	160	-0,1 1	10m	641,00
JA15-180	180	-0,1 1	10m	680,00
JA15-200	203	-0,1 1	10m	923,00
JA15-250	254	-0,1 1	10m	965,75
JA15-300	305	-0,1 1	10m	1197,00

Afskæres mellem 1 - 5m, ellers 10m.

Alfavac slange 10m

PU-L (POLYURETHAN)



Lamineret polyurethan slange med kobberbelagt stålspring. Anti-statisk. Bruges til sugning og transport af slibende materiale: træflis, savsmuld, korn, stålfibre.

-30° til +100°C

Varenr.	∅	VAC/BAR	L	DKK / m
JA23-250	250	-0,1 1	10m	569,25

Alfaspir N slange

PVC (POLYVINYLCHLORID)



PVC slange med hård PVC spiral. Glat indvendig overflade. Vacuumslange til støv, spåner osv.

0° til +60°C

Varenr.	∅	Max vac.	L	DKK / m
JA12-20	20	-0,5	50m	24,40
JA12-25	25	-0,5	50m	25,65
JA12-32	32	-0,45	50m	29,00
JA12-38	38	-0,45	50m	32,40
JA12-50	50	-0,4	50m	44,60
JA12-60	60	-0,4	50m	51,10
JA12-75	75	-0,4	50m	63,35
JA12-90	90	-0,4	50m	88,20
JA12-100	100	-0,4	30m	94,50
JA12-125	125	-0,4	30m	148,75
JA12-140	140	-0,35	30m	160,50
JA12-160	160	-0,35	20m	181,00
JA12-200	200	-0,25	20m	228,00

Afskæres mellem 1 - 5m, ellers fuld længde.



515

SLANGER TIL AFLØB OG FORURENEDE VÆSKER



NB! Der er afkortningstillæg på kr. 50 på alle slanger, der leveres afskåret.

Afklippede slanger tages ikke retur!

Slangestørrelser angives typisk i mm og svarer til følgende tommemål:

4mm = 1/8"
5mm = 3/16"

6mm = 1/4"
8mm = 5/16"
10mm = 3/8"
12mm = 1/2"
16mm = 5/8"
19mm = 3/4"
25mm = 1"
32mm = 1 1/4"
38mm = 1 1/2"

52mm = 2"
62mm = 2 1/2"
77mm = 3"
102mm = 4"
127mm = 5"
153mm = 6"

Amazone SE slange

PVC (POLYVINYLCHLORID)



Meget fleksibel PVC slange med blød PVC spiral. Anvendes til sugning af væsker, f.eks. ved afløb samt forurenede væsker.

-20° til +60°C

Varenr.	ø/Ø	bar 20°C	L	DKK / m
J30-20	20/27	6	50m	45,30
J30-25	25/32,4	6	50m	50,10
J30-30	30/37,8	6	50m	60,05
J30-32	32/40	6	50m	62,30
J30-35	35/43,4	6	50m	67,20
J30-38	38/46,6	6	50m	71,00
J30-40	40/48,8	6	50m	78,90
J30-45	45/54	5,5	50m	94,50
J30-50	50/59,8	5	50m	99,35
j30-60	60/70	5	50m	123,75
J30-63	63/73,4	4,5	50m	130,25
J30-70	70/80,8	4,5	50m	159,00
J30-76	76/87	4,5	50m	165,00
J30-80	80/92	4	50m	182,00
J30-90	90/102,6	4	50m	222,00
J30-100	102/115,2	3,5	50m	235,75
J30-110	110/123,8	3,5	30m	303,75
J30-125	125/140	3	20m	324,75
J30-150	150/167,6	2	20m	403,75
J30-200	200/224	1,5	10m	772,25

Afskæres mellem 1 - 5m, ellers fuld længde.

Opal slange

PVC (POLYVINYLCHLORID)

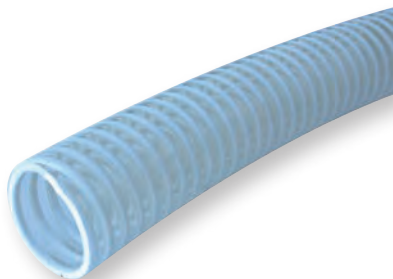

Fleksibel PVC slange med hård PVC spiral. Til sugning af væske, vanding uden tryk, afløb.

-10° til +60°C

Varenr.	ø/Ø	bar 20°C	L	DKK / m
J17P-1	13/19	7	50m	31,30
J17P-2	20/25,8	7	50m	33,80
J17P-3	25/30,8	7	50m	34,95
J17P-4	32/38,2	7	50m	39,80
J17P-5	38/44,8	7	50m	50,05
J17P-6	40/47,2	7	50m	51,80
J17P-7	50/58,2	6	50m	68,50
J17P-8	60/68,4	6	50m	77,55
J17P-9	75/84,6	5	50m	113,50
J17P-10	90/101	4	50m	147,50
J17P-10-1	100/112	4	50m	174,00
J17P-11	110/122,2	4	25m	201,00

Afskæres mellem 1 - 5m, ellers fuld længde.

SLANGER TIL SVØMMEBASSIN OG SANITET



NB! Der er afkortningstillæg på kr. 50 på alle slanger, der leveres afskåret.

Afklippede slanger tages ikke retur!

Slangestørrelser angives typisk i mm og svarer til følgende tommemål:

4mm = 1/8"

5mm = 3/16"

6mm = 1/4"

8mm = 5/16"

10mm = 3/8"

12mm = 1/2"

16mm = 5/8"

19mm = 3/4"

25mm = 1"

32mm = 1 1/4"

38mm = 1 1/2"

52mm = 2"

62mm = 2 1/2"

77mm = 3"

102mm = 4"

127mm = 5"

153mm = 6"

Aquastar slange 25m blå

PVC (POLYVINYLCHLORID)



Fleksibel PVC slange forstærket med hård PVC spiral. Glat ud- og indvendig. Beregnet til sug/tryk af vand til boblebad, svømmebassin og sanitære installationer.

-10° til +60°C

Varenr.	ø/Ø	bar 20°C	L	DKK / m
JA24B-1520	15/20	6	25m	36,70
JA24B-1925	19/25	6	25m	48,85
JA24B-2532	25/32	6	25m	50,85
JA24B-3240	32/40	5	25m	74,80
JA24B-4250	42/50	5	25m	77,85
JA24B-5563	55/63	5	25m	106,75
JA24B-6575	65/75	4	25m	155,75

Afskæres mellem 1 - 5m, ellers 25m.

Aquastar slange 25m grå

PVC (POLYVINYLCHLORID)

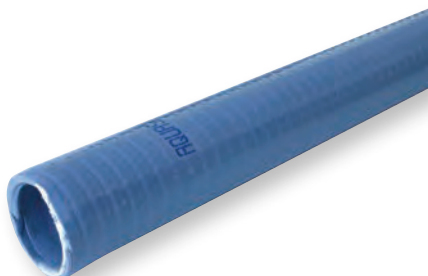

Fleksibel PVC slange forstærket med hård PVC spiral. Glat ud- og indvendig. Beregnet til sug/tryk af vand til boblebad, svømmebassin og sanitære installationer.

-10° til +60°C

Varenr.	ø/Ø	bar 20°C	L	DKK / m
JA24G-1520	15/20	6	25m	36,70
JA24G-1925	19/25	6	25m	48,85
JA24G-2532	25/32	6	25m	50,85
JA24G-3240	32/40	5	25m	74,80
JA24G-4250	42/50	5	25m	77,85
JA24G-5563	55/63	5	25m	106,75
JA24G-6575	65/75	4	25m	155,75

Afskæres mellem 1 - 5m, ellers 25m.



516

SLANGER TIL BRAND/ENTREPRENØR



NB! Der er afkortningstillæg på kr. 50 på alle slanger, der leveres afskåret.

Afklippede slanger tages ikke retur!

Slangestørrelser angives typisk i mm og svarer til følgende tommemål:

4mm = 1/8"
5mm = 3/16"

6mm = 1/4"
8mm = 5/16"
10mm = 3/8"
12mm = 1/2"
16mm = 5/8"
19mm = 3/4"
25mm = 1"
32mm = 1 1/4"
38mm = 1 1/2"

52mm = 2"
62mm = 2 1/2"
77mm = 3"
102mm = 4"
127mm = 5"
153mm = 6"

Brandslange

PVC (POLYVINYLCHLORID)

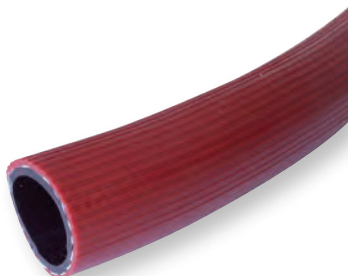

Forstærket PVC-brandslange produceret iht. EN 694 norm.

Varenr.	ø/Ø bar 20°C	L	DKK
JA9-1218	12,7/18 10	50m	994,25
JA9-1926	19/26 12	50m	1796,50
JA9-2533	25/33 12	50m	2430,00

Sælges kun i fuld længde.

Brandslange hvid

GUMMI



Brand- og entreprenør slange. Gummi lining med vulkaniseret tætvet stærk polyesterfiber.

-10° til +60°C				
Varenr.	Ø	bar 20°C	L	DKK
JA33-38	38 ~ 1 1/2"	15	40m	1761,50
JA33-40	40	15	40m	1841,75
JA33-45	45	15	40m	2171,25
JA33-50	50 ~ 2"	15	40m	2421,75
JA33-65	65 ~ 2 1/2"	15	40m	2961,25
JA33-70	70	15	40m	3536,00
JA33-75	75 ~ 3"	15	40m	3970,75
JA33-100	100 ~ 4"	15	40m	6350,00

Sælges kun i fuld længde.

Brandslange rød

GUMMI



Brand- og entreprenør slange. Gummi lining med vulkaniseret tætvet stærk polyesterfiber.

-10° til +60°C				
Varenr.	Ø	bar 20°C	L	DKK
JA34-38	38 ~ 1 1/2"	15	40m	2066,25
JA34-45	45	15	40m	2379,50
JA34-50	50 ~ 2"	15	40m	2712,00
JA34-65	65 ~ 2 1/2"	15	40m	3536,00
JA34-70	70	15	40m	3620,50
JA34-75	75 ~ 3"	15	40m	4035,75
JA34-100	100 ~ 4"	15	40m	8126,75

Sælges kun i fuld længde.

Forsyningslange afgrening

BSPP



Varenr.	BSPP	DKK
A155-4	1/2"	5,75
A155-5	3/4"	5,75

Forsyningslange flad type

PVC (POLYVINYLCHLORID)

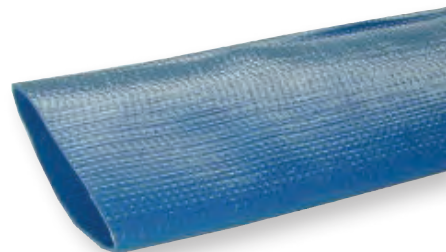

Varenr.	Ø	bar 20°C	L	DKK
J12-30	2"	5,5	100m	3038,50
J12-32	3"	3,8	100m	5330,25
J12-33	4"	3,8	100m	7068,00

Sælges kun i fuld længde.



113

SLANGER TIL FØDEVARER/KEMI



NB! Der er afkortningstillæg på kr. 50 på alle slanger, der leveres afskåret.

Afklippede slanger tages ikke retur!

Slangestørrelser angives typisk i mm og svarer til følgende tommemål:

4mm = 1/8"
5mm = 3/16"

6mm = 1/4"
8mm = 5/16"
10mm = 3/8"
12mm = 1/2"
16mm = 5/8"
19mm = 3/4"
25mm = 1"
32mm = 1 1/4"
38mm = 1 1/2"

52mm = 2"
62mm = 2 1/2"
77mm = 3"
102mm = 4"
127mm = 5"
153mm = 6"

Alfafood slange 40m

NBR / PVC / SBR



Indvendig NBR i fødevarekvalitet, forstærkende tekstilmellelag, udvendig blå NBR/PVC/SBR.

-30° til +85°C. Max 10 bar.

Varenr.	ø/Ø	BAR	L	DKK / m
JA40-13	13/21	10	40m	208,00
JA40-19	19/28	10	40m	261,00
JA40-25	25/36	10	40m	335,50

Denne slange kan leveres i afkortede længder op til max 5 meter. Afkortningsgebyr D.kr. 75,00.

Alfasteam slange 40m

EPDM



Indvendig EPDM i fødevarekvalitet, forstærkende tekstilmellelag, udvendig blå EPDM/CSM.

-30° til +165°C. Max 6 bar

Varenr.	ø/Ø	BAR	L	DKK / m
JA41-12	12,7/23	6	40m	175,50
JA41-19	19/30	6	40m	229,25
JA41-25	25/38	6	40m	303,75
JA41-32	32/46	6	40m	398,00
JA41-38	38/54	6	40m	501,25

Afskæres mellem 1 - 5m, ellers 40m.

Teflonslange 50m

PTFE (TEFLON)

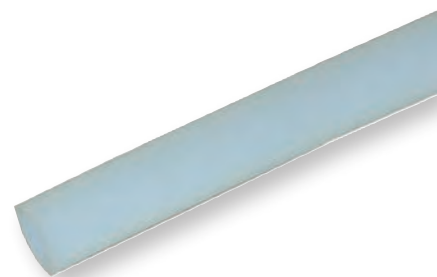

Lav friktion, egnet til næsten alle kemikalier og opløsningsmidler. Elektrisk isolerende og vejrbestandig, ideel til rustfri push-in og kompres.fittings.

-150° til +210°C

Varenr.	Ø/ø	BAR	L	DKK / m
J50000402	4/2	95	50m	87,35
J50000604	6/4	80	50m	95,90
J50000806	8/6	56	50m	122,25
J50001008	10/8	42	50m	152,75
J50001210	12/10	34	50m	216,75

Afskæres mellem 1 - 5m, ellers 50m.

Filclair N slange neutral PVC (POLYVINYLCHLORID)

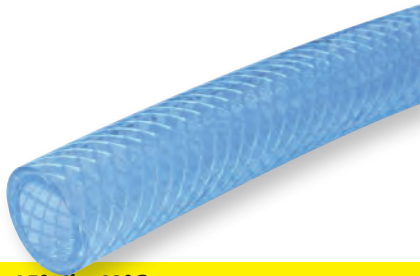

-15° til +60°C

Varenr.	ø/Ø	bar 20°C	L	DKK
J70200804	4/8	10	50m	488,50
J70201206	6/12	15	50m	663,00
J70201408	8/14	15	50m	719,00
J70201610	10/16	15	50m	808,25
J70201913	13/19	10	50m	1005,25
J70202216	16/22	10	50m	1278,25
J70202619	19/26	10	50m	1709,00
J70203325	25/33	10	50m	2160,00
J70204232	32/42	12	50m	4080,00
J70204838	38/48	10	50m	4596,00
J70206050	50/60	8	50m	5074,00

Sælges kun i fuld længde.

Filclair AL slange blå PVC (POLYVINYLCHLORID)

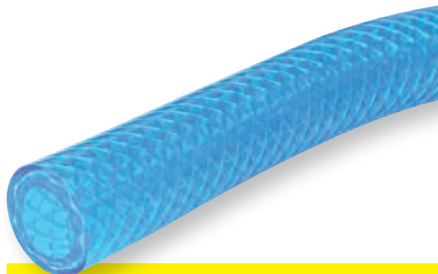

-15° til +60°C

Varenr.	ø/Ø	bar 20°C	L	DKK
J70241206	6/12	15	50m	663,00
J70241408	8/14	15	50m	719,00
J70241610	10/16	15	50m	808,25
J70241913	13/19	10	50m	1068,25

Sælges kun i fuld længde.

Filclair AL slange rød PVC (POLYVINYLCHLORID)



-15° til +60°C

Varenr.	ø/Ø	bar 20°C	L	DKK
J70231206	6/12	15	50m	663,00
J70231408	8/14	15	50m	719,00
J70231610	10/16	15	50m	808,25
J70231913	13/19	10	50m	1068,25

Sælges kun i fuld længde.

Cristal slange PVC (POLYVINYLCHLORID)

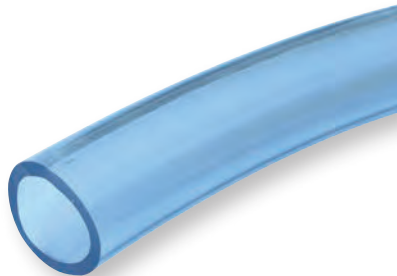

Klar PVC slange, uforstærket, brugbar til utallige trykløse formål.

-15° til +60°C

Varenr.	ø/Ø	bar 20°C	L	DKK
JA3-0204-100	2/4	0	100m	407,50
JA3-0305-100	3/5	0	100m	465,75
JA3-0406-100	4/6	0	100m	477,50
JA3-0608-50	6/8	0	50m	273,75
JA3-0608-100	6/8	0	100m	547,25
JA3-0609-100	6/9	0	100m	606,00
JA3-0810	8/10	0	50m	409,75
JA3-0812	8/12	0	50m	737,75
JA3-1013	10/13	0	50m	545,00
JA3-1216	12/16	0	50m	833,50
JA3-1620	16/20	0	50m	1087,75
JA3-1924	19/24	0	50m	1343,25
JA3-2531	25/31	0	50m	2402,00
JA3-3240	32/40	0	25m	2174,50
JA3-3848	38/48	0	25m	3025,25
JA3-5060	50/60	0	25m	4720,50
JA3-6070	60/70	0	25m	5565,25

Sælges kun i fuld længde.

Technitube slange PVC (POLYVINYLCHLORID)



Sort PVC udvendig, Hytrel indvendig. God modstandsevne mod de fleste syrer og baser.

-15° til +60°C

Varenr.	ø/Ø	bar 20°C	L	DKK
JA7-0611	6/11	20	50m	911,00
JA7-0814	8/14	20	50m	1094,00
JA7-0915	9/15	20	50m	1185,75
JA7-1016	10/16	20	50m	1214,50
JA7-1219	12,7/19,5	20	50m	1671,75
JA7-1623	16/23,5	20	50m	2153,75
JA7-1927	19/27,5	20	50m	2645,25
JA7-2534	25/34,5	15	50m	3613,25

Sælges kun i fuld længde.

Siliconeslange SILICONE

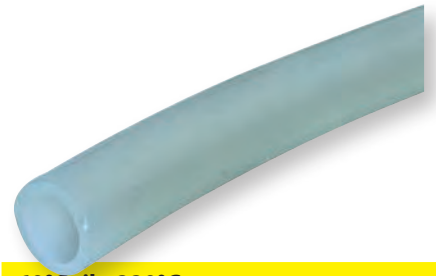

-60°C til +220°C

Varenr.	Ø/ø	L	DKK
J45070402	4/2	25m	214,25
J45070503	5/3	25m	308,00
J45070603	6/3	25m	354,75
J45070604	6/4	25m	376,75
J45070805	8/5	25m	523,25
J45071007	10/7	25m	682,75
J45071008	10/8	25m	682,75
J45071208	12/8	25m	843,50
J45071210	12/10	25m	843,50
J45071410	14/10	25m	1188,75
J45071712	17/12	25m	3052,00

Sælges kun i fuld længde.

SLANGER TIL DAMP



NB! Der er afkortningstillæg på kr. 50 på alle slanger, der leveres afskåret.

Afklippede slanger tages ikke retur!

Slangestørrelser angives typisk i mm og svarer til følgende tommemål:

4mm = 1/8"

5mm = 3/16"

6mm = 1/4"

8mm = 5/16"

10mm = 3/8"

12mm = 1/2"

16mm = 5/8"

19mm = 3/4"

25mm = 1"

32mm = 1 1/4"

38mm = 1 1/2"

52mm = 2"

62mm = 2 1/2"

77mm = 3"

102mm = 4"

127mm = 5"

153mm = 6"

Slange til damp

EPDM



Indvendig EPDM hvid gummi. Armering: 1 lag polyesteræv. Udvendig EPDM hvid gummi. (undtagen JA21-1, der er sort). Særdeles vej- og ældningsbestandig.

-30° til +170°C (JA21-1 +140°C)

Varenr.	ø/Ø	bar	20°C L	DKK / m
JA21-1	8/16	4	50m	36,40
JA21-3	13/25	7	40m	201,50
JA21-4	16/28	7	40m	230,00
JA21-5	19/32	7	40m	256,75
JA21-6	25/38	7	40m	324,00
JA21-7	32/47	7	40m	450,00
JA21-8	38/54	7	40m	490,25
JA21-9	51/66	7	40m	674,75

Afskæres mellem 1 - 5m, ellers fuld længde.



585

SLANGER TIL OLIE



NB! Der er afkortningstillæg på kr. 50 på alle slanger, der leveres afskåret.

Afklippede slanger tages ikke retur!

Slangestørrelser angives typisk i mm og svarer til følgende tommemål:

4mm = 1/8"
5mm = 3/16"

6mm = 1/4"
8mm = 5/16"
10mm = 3/8"
12mm = 1/2"
16mm = 5/8"
19mm = 3/4"
25mm = 1"
32mm = 1 1/4"
38mm = 1 1/2"

52mm = 2"
62mm = 2 1/2"
77mm = 3"
102mm = 4"
127mm = 5"
153mm = 6"

Fuelflex slange

PVC (POLYVINYLCHLORID)



Ekstra fleksibel, forstærket PVC slange til olie, alkohol osv.

50m længde er blå, 25m længde er sort.

Varenr.	ø/Ø	bar 20°C	L	DKK
JA8-0611	6,3/11	10	50m	882,00
JA8-0814	8/14	10	50m	1125,00
JA8-1016	10/16	10	50m	1214,50
JA8-1219	12/19	10	50m	1640,00
JA8-1523	15/23	10	50m	2122,00
JA8-2028	20/28	10	25m	1140,25
JA8-2532	25/32	8	25m	1336,00

Sælges kun i fuld længde.

Slange t. benzin 50m

NBR / PVC (POLYVINYLCHLORID)

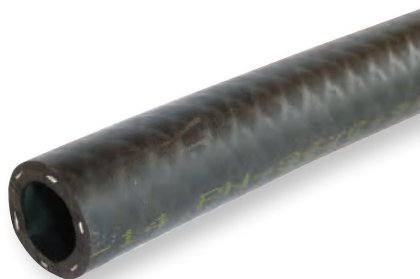

Indvendig NBR glat gummi. Armering: 1 lag PVA væv. Udvendig NBR/PVC sort glat gummi. Særdeles vejr- og ældningsbestandig

-30° til +100°C

Varenr.	ø/Ø	bar 20°C	L	DKK / m
JA19-2	5/11	10	50m	34,70
JA19-3	6/13	5	50m	35,55
JA19-5	8/15	10	50m	37,50
JA19-7	10/17	5	50m	42,90
JA19-10	12/19	5	50m	50,60

Afskæres mellem 1 - 5m, ellers 50m.



498

SLANGER TILBEHØR



Her findes slangeklippere, slangeklemmer, hætter og oprullere.

SLANGEFITTINGS & SLANGER

Slangeklipper POM (ACETAL)



L: 81mm, H: 27mm
Slange Ø: 2-12mm; PA, PE, PU, NYLON.

Blad = rustfrit stål

Varenr.	Ø	DKK
E1750	2 - 12	66,60

Slangeklipper POM (ACETAL)



Blad = rustfrit stål

Varenr.	Ø	DKK
E1759	10-30	113,75 ₪

₪ = nettopris

Slangeklipper STÅL



Varenr.	Ø	DKK
E1751	2 - 12	202,25
E1752	12 - 25	319,75

Løs klinge til E1751/1752

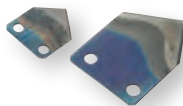

Varenr.	Ø	DKK
E1753	2 - 12	52,85
E1754	12 - 25	151,25

Slangeklipper STÅL



Varenr.	Ø	DKK
E1757	12-42	34,05 ₪

₪ = Nettopris, så længe lager haves.

Slangeholder AISI 304

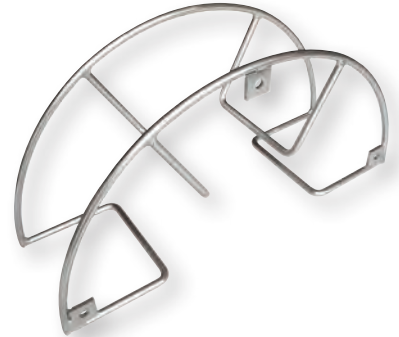

40m 1/2" eller 30m 3/4"

Varenr.	Evt.	DKK
N18-1	-	1157,75

Slangeholder AISI 304



25m 1/2" eller 20m 3/4"

Varenr.	Evt.	DKK
N18-2	-	769,75

Slangeopruller m. 1/2" nipler STÅL - BSPT



Epoxylakeret.
Leveringstid: 2 uger.

Varenr.	Kapacitet	DKK
Js2-1	70m 5/8"	964,50

Slangeopruller m. 3/4" nipler STÅL - BSPT



Epoxylakeret.
Leveringstid: 2 uger.

Varenr.	Kapacitet	DKK
Js4-1	100m 3/4"	3743,25

Slangeopruller m. 3/4" nipler STÅL - BSPT



Epoxylakeret.
Leveringstid: 2 uger.

Varenr.	Kapacitet	DKK
Js3-1	100m 3/4"	2030,25

Slangeopruller m. 3/4" nipler AISI 316 - BSPT



Leveringstid: 2 uger.

Varenr.	Kapacitet	DKK
Js5-1	100m 3/4"	8075,25

Slangeopruller m. 1/2" nipler BSPT

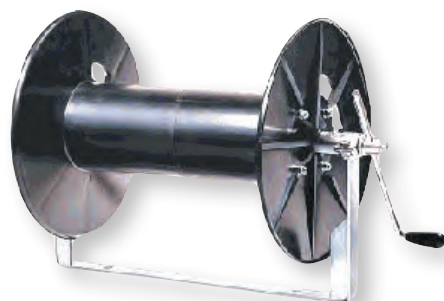

Varenr.	Kapacitet	DKK
J11-1	50m Ø18	2173,50

Hætte
ALUMINIUM



Varenr.	Ø1	- -	H	Ø3	DKK
8815-12A	12	1	17	8	2,55
8815-13A	13	1	17	9	2,55
8815-14A	14	1	20	9,5	2,55
8815-16A	16	1	20	12	2,55
8815-17.5A	17,5	0,75	23	13	2,55
8815-18A	18	1	23	13	2,21
8815-20A	20	1	25	15	2,55
8815-21A	21	1	26	15	3,46
8815-22A	22	1	25	15	3,46
8815-23A	23	1	26	17	4,59
8815-24A	24	1	26/30	15/17	5,75
8815-26A	26	1	30	20	6,50
8815-28A	28	1	30	20	6,50
8815-30A	30	1	31	20	7,10
8815-33A	33	1	33	26	8,65
8815-34A	34	1	34	26	12,65
8815-36A	36	1	35	26	15,45
8815-38A	38	1	36	26	19,35
8815-46.5A	46,5	1,75	53	37	17,55
8815-51A	51	2	50	36	25,65
8815-57A	57	1,5	50	44	28,70
8815-66.7A	66,7	1,65	56	52	26,15

Hætte
AISI 304



Varenr.	Ø1	- -	H	Ø3	DKK
8815-11RS	13	0,5	18	9,5	4,20
8815-15RS	14	0,5	18	9,7	4,38
8815-18RS	15	0,5	19	11,5	5,25 \square
8815-19RS	15	0,5	20	11,5	5,25
8815-21RS	15,5	0,5	20	11,5	5,25
8815-23RS	16	0,5	20	11,5	5,75
8815-27RS	17	0,5	21	11,6	6,35
8815-29RS	19	0,5	23	13,8	8,85
8815-31RS	19	0,5	23	14,3	8,85
8815-34RS	19,6	0,7	27	15,3	10,85
8815-35RS	20,6	0,7	24	14,5	11,15
8815-36RS	20,6	0,7	24	14,5	11,15 \square
8815-37RS	21,6	0,7	29	15	11,85
8815-39RS	23,6	0,7	27	17,5	17,55
8815-42RS	28,6	0,7	34	20	30,40
8815-44RS	45	1	46	34	75,35
8815-45RS	45	1	55	37	75,35
8815-46RS	55	1	62	42	81,10

\square = krave fornedet

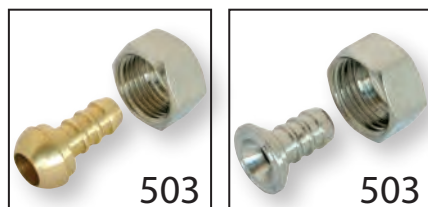
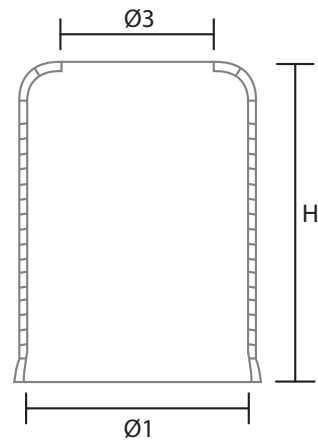

Slangeklemme rød
PVDF (POLYVINYLDENFLUORID) / STÅL



Varenr.	Str.	DKK
E1800-1	< Ø10	59,80
E1800-2	< Ø15	104,00
E1800-3	< Ø20	128,25

Slangeklemme blå
PVDF (POLYVINYLDENFLUORID) / STÅL



Varenr.	Str.	DKK
E1801-1	< Ø10	59,80 \square
E1801-2	< Ø15	104,00 \square
E1801-3	< Ø20	128,25 \square

Regn med leveringstid

Slangeklemme grøn
PVDF (POLYVINYLDENFLUORID) / STÅL



Varenr.	Str.	DKK
E1802-1	< Ø10	59,80 \square
E1802-2	< Ø15	104,00 \square
E1802-3	< Ø20	128,25 \square

Regn med leveringstid

Slangeklemme gul
PVDF (POLYVINYLDENFLUORID) / STÅL

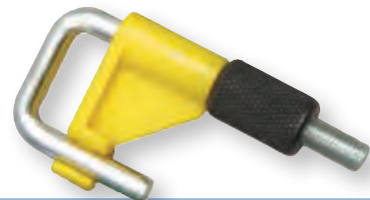

Varenr.	Str.	DKK
E1803-1	< Ø10	59,80 \square
E1803-2	< Ø15	104,00 \square
E1803-3	< Ø20	128,25 \square

Regn med leveringstid



Slangeklemme

POM (ACETAL)



Varenr.	Ø	DKK
E1810-1	1 - 5	16,95
E1810-2	3 - 10	43,25
E1810-3	6 - 15	63,35



Slangeklemme

POM (ACETAL) / AISI 304

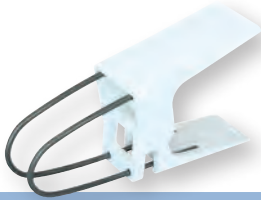

Varenr.	Ø	DKK
E1820-1	2 - 8	87,65
E1820-2	8 - 12	130,25

SLANGER TIL KØLEVÆSKE



Se tekst



-0°C til +65°C



Serien er egnet til: alkoholer, ethyl, acetone, kommercielle vaske- og rengøringsmidler, fedt, lak, opløsningsmidler og olie.

1/2": 1700l/time, max tryk 1,4-2bar
3/4": 1900l/time, max tryk 0,7-1,4bar

Ikke egnet til: syrer og stærke baser.

Tryk:

1/4": 900l/time, max tryk 2-3bar

3/8": 1500l/time, max tryk 2-3bar

SLANGEFITTINGS & SLANGER

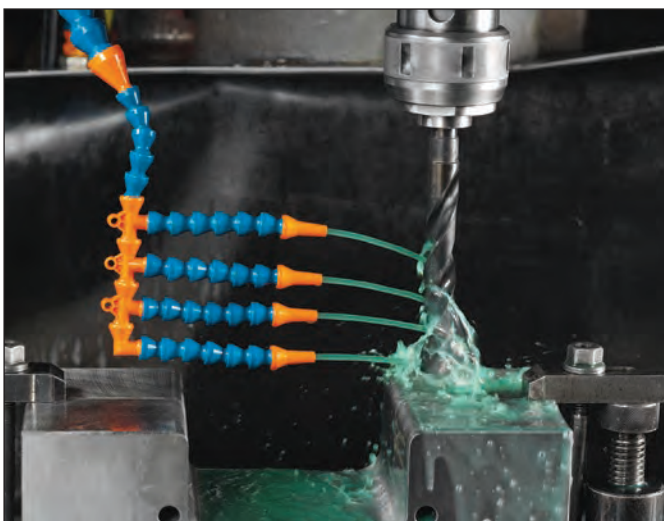

Kølevæskeslange

POM (ACETAL)



33 cm, med magnet

Varenr.	Size	DKK
FP1-2	1/4"	162,00

Kølevæskeslange

POM (ACETAL) - BSPT



33 cm, med ventil

Varenr.	BSPT	DKK
FP2-2	1/4"	90,35
FP2-3	3/8"	108,00
FP2-4	1/2"	118,75

Gevindstykke

POM (ACETAL) - BSPT



Varenr.	Size × BSPT	DKK/4 stk.
FP9-1	1/4" × 1/8"	23,05
FP9-2	1/4" × 1/4"	23,05
FP9-3	3/8" × 3/8"	30,70
FP9-6	3/8" × 1/2"	30,70
FP9-7	1/2" × 3/8"	37,85
FP9-4	1/2" × 1/2"	37,85
FP9-5	3/4" × 3/4"	76,45

Vinkelsamler

POM (ACETAL)



Varenr.	Size	DKK/2 stk.
FP11-2	1/4"	17,75
FP11-4	1/2"	32,70

T-stk reduktion

POM (ACETAL)



Varenr.	Size	DKK/2 stk.
FP12-2	1/4"	22,55
FP12-4	1/2"	41,20

Dobbeltmuffe

POM (ACETAL)



Varenr.	Size	DKK/4 stk.
FP13-2	1/4"	44,60
FP13-4	1/2"	73,45
FP13-5	3/4"	73,45

Samleled

POM (ACETAL)



Varenr.	Size	L	DKK
FP14-1	1/4"	2 × 14cm	54,00
FP14-4	3/8"	2 × 14,5cm	62,30
FP14-7	1/2"	2 × 14cm	71,80
FP14-10	3/4"	2 × 14,5cm	122,25

Samleled i rulle

POM (ACETAL)



Varenr.	Size	L	DKK
FP14-2	1/4"	15m	2845,00
FP14-3	1/4"	25m	4757,75
FP14-5	3/8"	7,5m	1749,00
FP14-6	3/8"	15m	3433,00
FP14-8	1/2"	15m	4144,75
FP14-9	1/2"	25m	6731,25
FP14-11	3/4"	15m	7080,25
FP14-12	3/4"	25m	11484,50

Y-reduktion

POM (ACETAL)



Varenr.	Size	DKK/2 stk.
FP7-2	1/4"	14,90
FP7-3	1/2"	28,10
FP7-4	1/2" × 1/4"	28,10
FP7-5	3/4" × 1/2"	56,25
FP7-6	3/4"	127,75

Forlængersamleled

POM (ACETAL)



Varenr.	Size	DKK/4 stk.
FP15-2	1/4"	126,50
FP15-4	1/2"	130,50

Forlængerled og holdere

POM (ACETAL)



Varenr.	Size	DKK/12 dele
FP16-2	1/4"	177,50
FP16-4	1/2"	246,50

Multidyse cirkel

POM (ACETAL)



15 dele, med prop

Varenr.	Size	DKK
FP4-2	1/4"	222,75
FP4-4	1/2"	274,00

Sidedyse

POM (ACETAL)



Varenr.	Size	ø	DKK/4 stk.
FP17-2	1/4"	1,75	39,20
FP17-4	1/2"	3,35	78,10

Dyse

POM (ACETAL)



Varenr.	Size	ø	DKK/4 stk.
FP18-1	1/4"	1,5	23,05
FP18-2	1/4"	4	23,05
FP18-3	1/4"	6,25	23,05
FP18-4	3/8"	6,25	30,70
FP18-5	3/8"	9,50	30,70
FP18-6	3/8"	12	30,70
FP18-7	1/2"	6,25	65,55
FP18-8	1/2"	9,75	65,55
FP18-9	1/2"	12,50	65,55
FP18-10	3/4"	15,75	76,45
FP18-11	3/4"	20,25	76,45

Flad dyse

POM (ACETAL)



Varenr.	Size	dim	DKK/2 stk.
FP19-1	1/4"	1,3 × 7	14,90
FP19-2	1/4"	1,75 × 25	14,90
FP19-3	3/8"	3,75 × 32	21,55
FP19-4	1/2"	3,5 × 60,5	58,75
FP19-5	3/4"	-	127,75

Multidyse

POM (ACETAL)



Varenr.	Size	dim	DKK/2 stk.
FP20-2	1/4"	6-ø2,35	18,35
FP20-4	1/2"	8-ø4,15	31,30

Dysesæt

POM (ACETAL)



Varenr.	Size	DKK/sæt
FP21-2	1/4"	34,05
FP21-4	1/2"	71,80

Vinkeldyse

POM (ACETAL)



Varenr.	Size	ø	DKK/4 stk.
FP22-1	1/4"	1,75	29,30
FP22-2	1/4"	3,00	29,30
FP22-3	1/4"	6,00	29,30
FP22-4	1/2"	6,25	58,45
FP22-5	1/2"	9,75	58,45
FP22-6	1/2"	12,50	58,45

Fordeler m. ventiler m. beslag

POM (ACETAL)

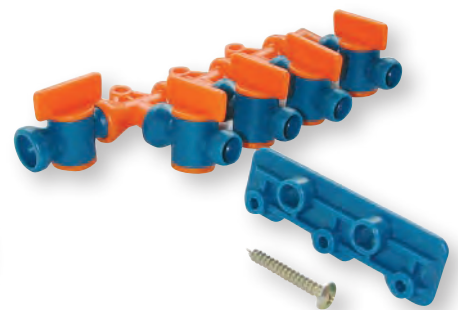

Varenr.	Size	DKK
FP5-2	1/4"	238,00
FP5-4	1/2"	410,50

Ventil

POM (ACETAL) - BSPT



Varenr.	BSPT	DKK/2 stk.
FP6-2	1/4"	72,10
FP6-3	3/8"	95,80
FP6-4	1/2"	120,00

Ventil m. indv. gevind

POM (ACETAL) - BSPP



Varenr.	BSPP	DKK/2 stk.
FP23-2	1/4"	72,10
FP23-3	3/8"	95,80
FP23-4	1/2"	120,00

Slangeventil

POM (ACETAL)



Varenr.	Size	DKK/2 stk.
FP24-2	1/4"	72,10
FP24-4	1/2"	120,00

Kontraventil

POM (ACETAL)



Varenr.	Size	DKK/2 stk.
FP25-2	1/4"	76,70
FP25-4	1/2"	130,50

Samle/skille tang



Varenr.	Size	DKK
FP10-2	1/4"	422,00
FP10-3	3/8"	422,00
FP10-4	1/2"	422,00
FP10-5	3/4"	422,00

Justerbar højtrykdyse

STÅL - BSPP



Ordre over 100 stk. kan leveres med NPT/
metrisk gevind. Leveringstid: 8 -12 uger

Varenr.	BSPP	L	DKK
FP26-1	1/8"	20mm	162,00
FP26-2	1/8"	40mm	179,75
FP26-3	1/8"	60mm	194,75
FP26-4	1/4"	20mm	162,00
FP26-5	1/4"	40mm	179,75
FP26-6	1/4"	60mm	194,75
FP26-7	3/8"	30mm	227,50
FP26-8	3/8"	50mm	244,25
FP26-9	3/8"	70mm	261,00
FP26-10	1/2"	40mm	292,25
FP26-11	1/2"	60mm	308,50
FP26-12	1/2"	80mm	325,00

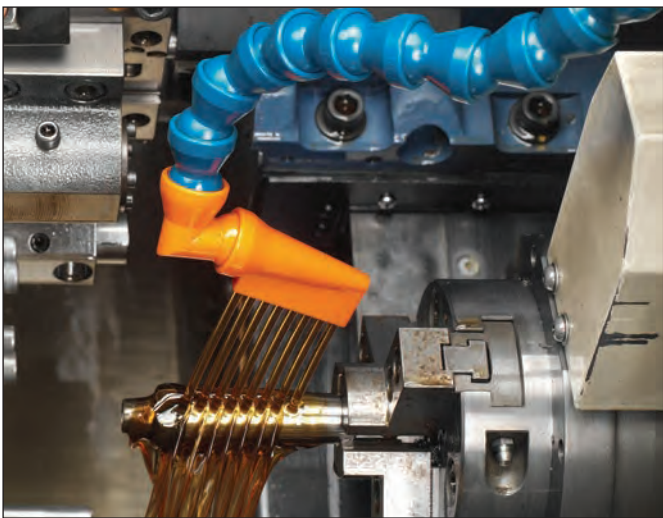

SORT, GALV, MESSING & ALU FITTINGS

 **554** GEVINDFITTINGS
SORT

 **561** GEVINDFITTINGS
GALVANISERET

 **571** GEVINDFITTINGS
MESSING

 **578** GEVINDFITTINGS MS
AFZINKNINGSBESTANDIG

 **580** GEVINDFITTINGS
BRONZE

 **582** GEVINDFITTINGS
SORT ALU

GEVINDFITTINGS SORT



Max 25 bar



120°C



DIN 2950



Høj kvalitet sorte fittings.

SORT, GALV, MESSING & ALU FITTINGS

Bøjning 90° lang nip/muf

SORT - BSPT×BSPP



Varenr.	BSPT×BSPP	DKK
000001102	1/4"	21,00
000001103	3/8"	21,00
000001104	1/2"	21,00
000001106	3/4"	28,40
000001108	1"	41,90
000001110	1 1/4"	68,00
000001111	1 1/2"	92,00
000001112	2"	141,50
000001113	2 1/2"	289,75
000001114	3"	418,25
000001116	4"	861,25

Bøjning 90° kort muf/muf

SORT - BSPP



Varenr.	BSPP	DKK
000020103	3/8"	16,40
000020104	1/2"	20,00
000020106	3/4"	31,00
000020108	1"	43,40
000020110	1 1/4"	68,00
000020111	1 1/2"	98,85
000020112	2"	204,75

Bøjning 45° nip/muf

SORT - BSPT×BSPP



Varenr.	BSPT×BSPP	DKK
000040102	1/4"	20,00
000040103	3/8"	20,00
000040104	1/2"	20,00
000040106	3/4"	26,00
000040108	1"	41,45
000040110	1 1/4"	61,70
000040111	1 1/2"	86,30
000040112	2"	135,50
000040113	2 1/2"	633,50
000040114	3"	642,75
000040116	4"	652,25

Bøjning 90° lang muf/muf

SORT - BSPP



Varenr.	BSPP	DKK
000002102	1/4"	21,00
000002103	3/8"	21,00
000002104	1/2"	21,00
000002106	3/4"	31,95
000002108	1"	46,35
000002110	1 1/4"	73,70
000002111	1 1/2"	105,00
000002112	2"	160,00
000002113	2 1/2"	530,50
000002114	3"	665,50
000002116	4"	923,00

Bøjning 90° kort nip/muf

SORT - BSPT×BSPP



Varenr.	BSPT×BSPP	DKK
000010103	3/8"	16,40
000010104	1/2"	20,00
000010106	3/4"	27,40
000010108	1"	39,35
000010110	1 1/4"	64,95
000010111	1 1/2"	86,30
000010112	2"	141,50

Bøjning 45° muf/muf

SORT - BSPP



Varenr.	BSPP	DKK
000041103	3/8"	21,55
000041104	1/2"	21,55
000041106	3/4"	34,40
000041108	1"	49,35
000041110	1 1/4"	80,25
000041111	1 1/2"	110,50
000041112	2"	172,75
000041113	2 1/2"	420,25
000041114	3"	462,00

Vinkel 90° muf/muf
SORT - BSPP



Varenr.	BSPP	DKK
000090102	1/4"	12,55
000090103	3/8"	12,55
000090104	1/2"	12,55
000090106	3/4"	16,05
000090108	1"	24,95
000090110	1 1/4"	36,95
000090111	1 1/2"	49,35
000090112	2"	73,70
000090113	2 1/2"	187,50
000090114	3"	196,75
000090116	4"	357,50

Vinkel 90° nip/muf
SORT - BSPT×BSPP



Varenr.	BSPT×BSPP	DKK
000092102	1/4"	13,50
000092103	3/8"	13,50
000092104	1/2"	13,50
000092106	3/4"	18,05
000092108	1"	26,45
000092110	1 1/4"	46,35
000092111	1 1/2"	56,85
000092112	2"	80,25
000092113	2 1/2"	178,75
000092114	3"	277,00
000092116	4"	462,00

Union 90° nip/muf
SORT - BSPT×BSPP



Varenr.	BSPT×BSPP	DKK
000098103	3/8"	68,00
000098104	1/2"	68,00
000098106	3/4"	89,00
000098108	1"	105,00
000098110	1 1/4"	148,25
000098111	1 1/2"	185,25
000098112	2"	271,25

Vinkel 45° muf/muf
SORT - BSPP



Varenr.	BSPP	DKK
000120103	3/8"	13,50
000120104	1/2"	11,00
000120106	3/4"	16,45
000120108	1"	24,95
000120110	1 1/4"	39,90
000120111	1 1/2"	49,35
000120112	2"	73,70
000120113	2 1/2"	436,00
000120114	3"	396,00

Vinkel 90° red. muf/muf
SORT - BSPP



Varenr.	BSPP	DKK
000090126	1/2" × 3/8"	15,00
000090132	3/4" × 3/8"	18,05
000090133	3/4" × 1/2"	18,05
000090142	1" × 1/2"	26,95
000090143	1" × 3/4"	26,95
000090149	1 1/4" × 1/2"	29,30
000090150	1 1/4" × 3/4"	40,95
000090151	1 1/4" × 1"	43,85
000090157	1 1/2" × 3/4"	54,35
000090158	1 1/2" × 1"	54,35
000090159	1 1/2" × 1 1/4"	54,35
000090165	2" × 1"	80,25
000090166	2" × 1 1/4"	80,25
000090167	2" × 1 1/2"	80,25

Vinkel 90° red. nip/muf
SORT - BSPT×BSPP



Varenr.	BSPT×BSPP	DKK
000092126	3/8" × 1/2"	21,95
000092133	1/2" × 3/4"	31,45
000092143	3/4" × 1"	36,95

Union 90° muf/muf
SORT - BSPP



Varenr.	BSPP	DKK
000096103	3/8"	61,70
000096104	1/2"	61,70
000096106	3/4"	80,25
000096108	1"	92,00
000096110	1 1/4"	130,00
000096111	1 1/2"	166,75
000096112	2"	246,25

Vinkel 45° nip/muf
SORT - BSPT×BSPP



Varenr.	BSPT×BSPP	DKK
000121103	3/8"	18,45
000121104	1/2"	18,45
000121106	3/4"	28,40
000121108	1"	37,40
000121110	1 1/4"	61,70
000121111	1 1/2"	73,70
000121112	2"	123,25
000121113	2 1/2"	531,00
000121114	3"	653,25

T-stk m. muffer

SORT - BSPP



Varenr.	BSPP	DKK
000130101	1/8"	20,50
000130102	1/4"	15,55
000130103	3/8"	15,55
000130104	1/2"	15,55
000130106	3/4"	20,50
000130108	1"	31,95
000130110	1 1/4"	47,85
000130111	1 1/2"	61,70
000130112	2"	92,00
000130113	2 1/2"	196,75
000130114	3"	258,75
000130116	4"	467,75

Strøm T-stk m. muffer

SORT - BSPP



Varenr.	BSPP	DKK
000131104	1/2"	23,50
000131106	3/4"	33,00
000131108	1"	51,90
000131110	1 1/4"	77,85
000131111	1 1/2"	99,70
000131112	2"	150,75

Y-stk m. muffer

SORT - BSPP



Varenr.	BSPP	DKK
000165104	1/2"	93,90
000165106	3/4"	132,75
000165108	1"	169,75
000165110	1 1/4"	208,75
000165111	1 1/2"	232,25
000165112	2"	324,50

T-stk red. m. muffer

SORT - BSPP



Varenr.	BSPP	DKK
000130211	3/8" x 1/4" x 3/8"	21,00
000130212	3/8" x 1/2" x 3/8"	21,00
000130125	1/2" x 1/4" x 1/2"	21,00
000130219	1/2" x 3/8" x 3/8"	20,15
000130126	1/2" x 3/8" x 1/2"	21,00
000130121	1/2" x 1/2" x 3/8"	21,00
000130225	1/2" x 3/4" x 1/2"	25,50
000130227	1/2" x 1" x 1/2"	24,50
000130131	3/4" x 1/4" x 3/4"	25,50
000130231	3/4" x 3/8" x 1/2"	24,50
000130132	3/4" x 3/8" x 3/4"	25,50
000130237	3/4" x 1/2" x 1/2"	24,50
000130133	3/4" x 1/2" x 3/4"	25,50
000130241	3/4" x 3/4" x 1/2"	25,50
000130147	3/4" x 1" x 3/4"	38,90
000130141	1" x 3/8" x 1"	38,90
000130257	1" x 1/2" x 1/2"	38,90
000130142	1" x 1/2" x 1"	38,90
000130264	1" x 3/4" x 1/2"	38,90
000130266	1" x 3/4" x 3/4"	38,90
000130143	1" x 3/4" x 1"	38,90
000130270	1" x 1" x 1/2"	38,90
000130272	1" x 1" x 3/4"	38,90
000130281	1" x 1 1/2" x 1"	73,70

Kryds m. muffer

SORT - BSPP



Varenr.	BSPP	DKK
000180103	3/8"	31,00
000180104	1/2"	31,00
000180106	3/4"	43,40
000180108	1"	58,75
000180110	1 1/4"	86,30
000180111	1 1/2"	117,25
000180112	2"	160,00
000180113	2 1/2"	346,25
000180114	3"	431,25
000180116	4"	799,75

000130148	1 1/4" x 3/8" x 1 1/4"	56,45
000130288	1 1/4" x 1/2" x 1"	58,75
000130149	1 1/4" x 1/2" x 1 1/4"	58,75
000130290	1 1/4" x 3/4" x 3/4"	58,75
000130150	1 1/4" x 3/4" x 1 1/4"	58,75
000130297	1 1/4" x 1" x 1"	58,75
000130151	1 1/4" x 1" x 1 1/4"	58,75
000130301	1 1/4" x 1 1/4" x 3/4"	56,45
000130302	1 1/4" x 1 1/4" x 1"	58,75
000130157	1 1/2" x 3/4" x 1 1/2"	73,70
000130321	1 1/2" x 1" x 1"	70,85
000130322	1 1/2" x 1" x 1 1/4"	73,70
000130326	1 1/2" x 1 1/4" x 1 1/4"	70,85
000130159	1 1/2" x 1 1/4" x 1 1/2"	73,70
000130163	2" x 1/2" x 2"	105,00
000130164	2" x 3/4" x 2"	105,00
000130165	2" x 1" x 2"	105,00
000130166	2" x 1 1/4" x 2"	105,00
000130356	2" x 1 1/2" x 1 1/2"	105,00
000130167	2" x 1 1/2" x 2"	105,00
000130171	2 1/2" x 1" x 2 1/2"	216,00
000130172	2 1/2" x 1 1/4" x 2 1/2"	252,50
000130173	2 1/2" x 1 1/2" x 2 1/2"	268,00
000130174	2 1/2" x 2" x 2 1/2"	293,75
000130181	3" x 2 1/2" x 3"	308,00

Vinkel 90° m. sideudløb

SORT - BSPP



Varenr.	BSPP	DKK
000221103	3/8"	45,35
000221104	1/2"	49,45
000221106	3/4"	53,60
000221108	1"	59,75
000221110	1 1/4"	149,50
000221111	1 1/2"	396,75
000221112	2"	422,50

T-stk m. sideudløb

SORT - BSPP



Varenr.	BSPP	DKK
000223104	1/2"	86,55
000223106	3/4"	108,25
000223108	1"	158,50

Brystnippel

SORT - BSPT



Varenr.	BSPT	DKK
000280101	1/8"	12,55
000280102	1/4"	9,50
000280103	3/8"	9,50
000280104	1/2"	9,50
000280106	3/4"	12,55
000280108	1"	17,45
000280110	1 1/4"	25,50
000280111	1 1/2"	35,45
000280112	2"	48,40
000280113	2 1/2"	80,25
000280114	3"	135,50
000280116	4"	216,00

Formmuffe

SORT - BSPP



Varenr.	BSPP	DKK
000240120	1/4" x 1/8"	10,60
000240121	3/8" x 1/8"	10,60
000240122	3/8" x 1/4"	10,60
000240125	1/2" x 1/4"	10,60
000240126	1/2" x 3/8"	10,60
000240132	3/4" x 3/8"	15,00
000240133	3/4" x 1/2"	15,00
000240141	1" x 3/8"	20,00
000240142	1" x 1/2"	20,00
000240143	1" x 3/4"	20,00
000240148	1 1/4" x 3/8"	28,85
000240149	1 1/4" x 1/2"	28,90
000240150	1 1/4" x 3/4"	28,90
000240151	1 1/4" x 1"	28,90
000240156	1 1/2" x 1/2"	34,40
000240157	1 1/2" x 3/4"	34,40
000240158	1 1/2" x 1"	34,40
000240159	1 1/2" x 1 1/4"	34,40
000240163	2" x 1/2"	52,40
000240164	2" x 3/4"	52,40
000240165	2" x 1"	52,40
000240166	2" x 1 1/4"	52,40
000240167	2" x 1 1/2"	52,40
000240171	2 1/2" x 1"	125,00
000240172	2 1/2" x 1 1/4"	139,50
000240173	2 1/2" x 1 1/2"	98,85
000240174	2 1/2" x 2"	98,85
000240179	3" x 1 1/2"	154,00
000240180	3" x 2"	154,00
000240181	3" x 2 1/2"	154,00
000240191	4" x 2"	372,75
000240192	4" x 2 1/2"	391,00
000240193	4" x 3"	396,75

Overbøjning muf/muf

SORT - BSPP



Varenr.	BSPP	DKK
000085103	3/8"	187,50
000085104	1/2"	42,25
000085106	3/4"	64,60
000085225	3/4" x 1/2"	309,25
000085108	1"	163,00
000085110	1 1/4"	269,25

Brystnippel reduktion

SORT - BSPT



Varenr.	BSPT	DKK
000245120	1/4" x 1/8"	12,55
000245121	3/8" x 1/8"	12,55
000245122	3/8" x 1/4"	12,55
000245125	1/2" x 1/4"	12,55
000245126	1/2" x 3/8"	12,55
000245132	3/4" x 3/8"	15,55
000245133	3/4" x 1/2"	15,55
000245142	1" x 1/2"	22,50
000245143	1" x 3/4"	22,50
000245149	1 1/4" x 1/2"	36,95
000245150	1 1/4" x 3/4"	36,95
000245151	1 1/4" x 1"	36,95
000245157	1 1/2" x 3/4"	46,35
000245158	1 1/2" x 1"	46,35
000245159	1 1/2" x 1 1/4"	46,35
000245165	2" x 1"	68,00
000245166	2" x 1 1/4"	68,00
000245167	2" x 1 1/2"	68,00
000245173	2 1/2" x 1 1/2"	83,00
000245174	2 1/2" x 2"	123,25
000245180	3" x 2"	209,50
000245181	3" x 2 1/2"	209,50

Nippelmuffe

SORT - BSPT×BSPP

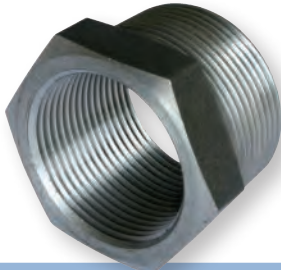

Varenr.	BSPT×BSPP	DKK
000241120	1/4" × 1/8"	9,50
000241121	3/8" × 1/8"	9,50
000241122	3/8" × 1/4"	9,50
000241125	1/2" × 1/4"	9,50
000241126	1/2" × 3/8"	9,50
000241131	3/4" × 1/4"	10,60
000241132	3/4" × 3/8"	10,60
000241133	3/4" × 1/2"	10,60
000241141	1" × 3/8"	15,55
000241142	1" × 1/2"	15,55
000241143	1" × 3/4"	15,55
000241148	1 1/4" × 3/8"	24,95
000241149	1 1/4" × 1/2"	24,95
000241150	1 1/4" × 3/4"	24,95
000241151	1 1/4" × 1"	24,95
000241156	1 1/2" × 1/2"	28,90
000241157	1 1/2" × 3/4"	28,90
000241158	1 1/2" × 1"	28,90
000241159	1 1/2" × 1 1/4"	28,90
000241163	2" × 1/2"	39,90
000241164	2" × 3/4"	39,90
000241165	2" × 1"	39,90
000241166	2" × 1 1/4"	39,90
000241167	2" × 1 1/2"	39,90
000241171	2 1/2" × 1"	68,00
000241172	2 1/2" × 1 1/4"	68,00
000241173	2 1/2" × 1 1/2"	65,15
000241174	2 1/2" × 2"	68,00
000241177	3" × 1"	98,85
000241178	3" × 1 1/4"	127,75
000241179	3" × 1 1/2"	140,25
000241180	3" × 2"	98,85
000241181	3" × 2 1/2"	98,85
000241191	4" × 2"	185,25
000241192	4" × 2 1/2"	251,50
000241193	4" × 3"	185,25

Spidsmuffe

SORT - BSPP×BSPT



Varenr.	BSPP×BSPT	DKK
000246120	1/4" × 1/8"	21,00
000246122	3/8" × 1/4"	21,00
000246125	1/2" × 1/4"	21,00
000246126	1/2" × 3/8"	21,00
000246132	3/4" × 3/8"	26,95
000246133	3/4" × 1/2"	26,95
000246142	1" × 1/2"	38,40
000246143	1" × 3/4"	38,40
000246150	1 1/4" × 3/4"	54,35
000246151	1 1/4" × 1"	54,35
000246158	1 1/2" × 1"	64,95
000246159	1 1/2" × 1 1/4"	64,95
000246166	2" × 1 1/4"	92,00
000246167	2" × 1 1/2"	92,00

Muffe

SORT - BSPP



Varenr.	BSPP	DKK
000270101	1/8"	11,50
000270102	1/4"	10,00
000270103	3/8"	10,00
000270104	1/2"	10,00
000270106	3/4"	12,00
000270108	1"	15,00
000270110	1 1/4"	27,95
000270111	1 1/2"	33,85
000270112	2"	52,40
000270113	2 1/2"	92,00
000270114	3"	135,50
000270116	4"	221,75

Muffe smedet

SORT - BSPP



Varenr.	BSPP	DKK
013270104	1/2"	10,85
013270108	1"	11,50

Prop firkantet m. kant

SORT - BSPT



Varenr.	BSPT	DKK
000290102	1/4"	7,55
000290103	3/8"	7,55
000290104	1/2"	7,55
000290106	3/4"	9,50
000290108	1"	12,55
000290110	1 1/4"	18,45
000290111	1 1/2"	21,55
000290112	2"	31,00
000290113	2 1/2"	61,70
000290114	3"	86,30
000290116	4"	154,00

Prop firkantet u. kant

SORT - BSPT



Varenr.	BSPT	DKK
000291101	1/8"	24,70
000291102	1/4"	10,70
000291103	3/8"	7,30
000291104	1/2"	7,75
000291106	3/4"	10,10
000291108	1"	12,20
000291110	1 1/4"	18,75
000291111	1 1/2"	72,90
000291112	2"	33,05
000291113	2 1/2"	60,35
000291114	3"	72,90
000291116	4"	146,75

Slutmuffe

SORT - BSPP



Varenr.	BSPP	DKK
000300103	3/8"	8,55
000300104	1/2"	8,55
000300106	3/4"	10,60
000300108	1"	15,00
000300110	1 1/4"	21,55
000300111	1 1/2"	28,40
000300112	2"	39,35
000300113	2 1/2"	80,25
000300114	3"	110,50
000300116	4"	185,25

Kontramøtrik

SORT - BSPP



Varenr.	BSPP	DKK
000310102	1/4"	8,05
000310103	3/8"	8,05
000310104	1/2"	8,05
000310106	3/4"	8,05
000310108	1"	10,00
000310110	1 1/4"	13,00
000310111	1 1/2"	17,00
000310112	2"	37,10
000310113	2 1/2"	49,35
000310114	3"	73,70

Union konisk muf/muf

SORT - BSPP



Varenr.	BSPP	DKK
000340102	1/4"	46,35
000340103	3/8"	46,35
000340104	1/2"	46,35
000340106	3/4"	58,75
000340108	1"	68,00
000340110	1 1/4"	92,00
000340111	1 1/2"	123,25
000340112	2"	185,25
000340113	2 1/2"	308,00
000340114	3"	522,75
000340116	4"	811,50

Union konisk nip/muf

SORT - BSPT×BSPP



Varenr.	BSPT×BSPP	DKK
000341102	1/4"	52,40
000341103	3/8"	52,40
000341104	1/2"	52,40
000341106	3/4"	68,00
000341108	1"	80,25
000341110	1 1/4"	105,00
000341111	1 1/2"	141,50
000341112	2"	209,50
000341113	2 1/2"	363,25
000341114	3"	615,00

Forlænger

SORT - BSPT×BSPP



Varenr.	BSPT×BSPP	DKK
000529103	3/8"	18,45
000529104	1/2"	18,45
000529106	3/4"	21,55
000529108	1"	31,00

Nippelrør 1/4"

SORT - BSPT



Varenr.	L	DKK
012060102	60mm	13,50
012080102	80mm	11,00

Nippelrør 3/8"

SORT - BSPT



Varenr.	L	DKK
012001103	WIW	10,20
012040103	40mm	13,80
012060103	60mm	13,50
012080103	80mm	13,50
012090103	90mm	14,75
012100103	100mm	17,00
012120103	120mm	18,15
012150103	150mm	20,05
012200103	200mm	19,40
012300103	300mm	35,45

WIW = sammenskåret

Nippelrør 1/2"

SORT - BSPT



Varenr.	L	DKK
012001104	WIW	5,60
012030104	30mm	7,75
012040104	40mm	6,00
012050104	50mm	5,75
012060104	60mm	6,00
012080104	80mm	11,00
012090104	90mm	6,60
012100104	100mm	7,85
012120104	120mm	13,00
012150104	150mm	11,25
012200104	200mm	21,55
012300104	300mm	32,40

WIW = sammenskåret

Nippelrør 3/4"
SORT - BSPT



Varenr.	L	DKK
012001106	WIW	6,50
012040106	40mm	6,95
012050106	50mm	6,80
012060106	60mm	7,85
012080106	80mm	12,00
012090106	90mm	8,35
012100106	100mm	9,15
012120106	120mm	15,35
012150106	150mm	13,50
012200106	200mm	27,95
012250106	250mm	34,90
012300106	300mm	41,90

WIW = sammenskåret

Nippelrør 1"
SORT - BSPT



Varenr.	L	DKK
012001108	WIW	14,80
012040108	40mm	9,75
012050108	50mm	9,35
012060108	60mm	19,05
012080108	80mm	20,50
012090108	90mm	18,30
012120108	120mm	16,05
012150108	150mm	34,90
012200108	200mm	42,90
012300108	300mm	64,95

WIW = sammenskåret

Nippelrør 1 1/4"
SORT - BSPT



Varenr.	L	DKK
012001110	WIW	22,75
012080110	80mm	27,40
012090110	90mm	19,85
012120110	120mm	20,70
012150110	150mm	41,45
012200110	200mm	50,85

WIW = sammenskåret

Nippelrør 1 1/2"
SORT - BSPT



Varenr.	L	DKK
012060111	60mm	19,40
012090111	90mm	22,75
012120111	120mm	28,45
012200111	200mm	38,15

Nippelrør 2"
SORT - BSPT



Varenr.	L	DKK
012080112	80mm	25,55
012150112	150mm	67,20
012200112	200mm	47,85
012300112	300mm	123,25

Nippelrør 2 1/2"
SORT - BSPT



Varenr.	L	DKK
012200113	200mm	86,30

Nippelrør 3"
SORT - BSPT



Varenr.	L	DKK
012200114	200mm	122,25

Nippelrør 4"
SORT - BSPT



Varenr.	L	DKK
012200116	200mm	195,50

GEVINDFITTINGS GALVANISERET



Max 25 bar



120°C



DIN 2950, DIN 2982



Høj kvalitet galvaniserede fittings inkl. nippelrør.

Fittings fremstillet efter DIN 2950, nippelrør efter DIN 2982.

Galvaniseret rør glat 2m GALVANISERET

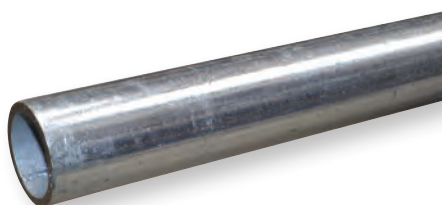

Varenr.	Str.	DKK
GK36-4	1/2"	84,10
GK36-5	3/4"	99,35
GK36-6	1"	141,50
GK36-7	1 1/4"	172,25
GK36-8	1 1/2"	195,00
GK36-9	2"	271,50

Bøjning 90° lang nip/muf GALVANISERET - BSPT×BSPP



Varenr.	BSPT×BSPP	DKK
000001402	1/4"	23,50
000001403	3/8"	23,50
000001404	1/2"	23,50
000001406	3/4"	31,45
000001408	1"	46,45
000001410	1 1/4"	75,35
000001411	1 1/2"	102,75
000001412	2"	158,00
000001413	2 1/2"	731,50
000001414	3"	464,75
000001416	4"	957,00

Bøjning 90° kort nip/muf GALVANISERET - BSPT×BSPP



Varenr.	BSPT×BSPP	DKK
000010404	1/2"	21,95
000010406	3/4"	29,95
000010408	1"	43,85
000010410	1 1/4"	71,80
000010411	1 1/2"	95,80
000010412	2"	158,00
000010414	3"	445,50
000010416	4"	917,00

Bøjning 90° lang muf/muf GALVANISERET - BSPP



Varenr.	BSPP	DKK
000002402	1/4"	23,50
000002403	3/8"	23,50
000002404	1/2"	23,50
000002406	3/4"	35,45
000002408	1"	51,25
000002410	1 1/4"	82,15
000002411	1 1/2"	116,25
000002412	2"	178,00
000002413	2 1/2"	376,25
000002414	3"	492,25
000002416	4"	1648,00

Bøjning 90° kort muf/muf GALVANISERET - BSPP



Varenr.	BSPP	DKK
000020404	1/2"	21,95
000020406	3/4"	34,40
000020408	1"	47,85
000020410	1 1/4"	75,35
000020411	1 1/2"	109,75
000020412	2"	171,00

Bøjning 90° kort nip/nip GALVANISERET - BSPP



Varenr.	BSPP	DKK
000003403	3/8"	74,80
000003404	1/2"	70,15
000003406	3/4"	78,65
000003408	1"	112,50
000003410	1 1/4"	234,25
000003411	1 1/2"	331,25
000003412	2"	446,75

Bøjning 45° nip/muf
GALVANISERET - BSPT×BSPP



Varenr.	BSPT×BSPP	DKK
000040402	1/4"	21,95
000040403	3/8"	21,95
000040404	1/2"	21,95
000040406	3/4"	28,90
000040408	1"	45,80
000040410	1 1/4"	68,50
000040411	1 1/2"	95,80
000040412	2"	150,75
000040413	2 1/2"	314,50
000040414	3"	431,25
000040416	4"	1153,75

Vinkel 90° muf/muf
GALVANISERET - BSPP



Varenr.	BSPP	DKK
000090402	1/4"	13,50
000090403	3/8"	13,50
000090404	1/2"	12,55
000090406	3/4"	18,05
000090408	1"	27,40
000090410	1 1/4"	40,90
000090411	1 1/2"	54,80
000090412	2"	82,15
000090413	2 1/2"	364,75
000090414	3"	219,00
000090416	4"	396,75

Vinkel 90° nip/muf
GALVANISERET - BSPT×BSPP



Varenr.	BSPT×BSPP	DKK
000092402	1/4"	15,00
000092403	3/8"	15,00
000092404	1/2"	13,50
000092406	3/4"	20,00
000092408	1"	29,50
000092410	1 1/4"	51,25
000092411	1 1/2"	62,80
000092412	2"	88,45
000092413	2 1/2"	198,75
000092414	3"	308,00
000092416	4"	512,75

Bøjning 45° muf/muf
GALVANISERET - BSPP



Varenr.	BSPP	DKK
000041403	3/8"	23,90
000041404	1/2"	23,90
000041406	3/4"	38,40
000041408	1"	54,80
000041410	1 1/4"	88,45
000041411	1 1/2"	123,25
000041412	2"	191,50
000041413	2 1/2"	341,75
000041414	3"	512,75
000041416	4"	983,00

Vinkel 90° red. muf/muf
GALVANISERET - BSPP



Varenr.	BSPP	DKK
000090422	3/8" × 1/4"	16,45
000090426	1/2" × 3/8"	15,00
000090432	3/4" × 3/8"	20,00
000090433	3/4" × 1/2"	20,00
000090442	1" × 1/2"	29,95
000090443	1" × 3/4"	29,95
000090449	1 1/4" × 1/2"	34,90
000090450	1 1/4" × 3/4"	42,05
000090451	1 1/4" × 1"	48,40
000090457	1 1/2" × 3/4"	60,35
000090458	1 1/2" × 1"	60,35
000090459	1 1/2" × 1 1/4"	60,35
000090465	2" × 1"	88,45
000090466	2" × 1 1/4"	88,45
000090467	2" × 1 1/2"	88,45
000090474	2 1/2" × 2"	147,50

Vinkel 90° red. nip/muf
GALVANISERET - BSPT×BSPP



Varenr.	BSPT×BSPP	DKK
000092426	3/8" × 1/2"	23,90
000092433	1/2" × 3/4"	34,40
000092443	3/4" × 1"	40,90

Vinkel 45° muf/muf
GALVANISERET - BSPP



Varenr.	BSPP	DKK
000120403	3/8"	15,00
000120404	1/2"	12,55
000120406	3/4"	18,45
000120408	1"	27,40
000120410	1 1/4"	44,40
000120411	1 1/2"	54,80
000120412	2"	82,15
000120413	2 1/2"	272,00
000120414	3"	260,50

Overbøjning muf/muf
GALVANISERET - BSPP



Varenr.	BSPP	DKK
000085403	3/8"	219,75
000085404	1/2"	53,30
000085406	3/4"	79,65
000085408	1"	210,25

T-stk m. muffer
GALVANISERET - BSPP



Varenr.	BSPP	DKK
000130401	1/8"	22,50
000130402	1/4"	17,00
000130403	3/8"	17,00
000130404	1/2"	16,05
000130406	3/4"	22,50
000130408	1"	35,45
000130410	1 1/4"	53,35
000130411	1 1/2"	78,10
000130412	2"	102,75
000130413	2 1/2"	219,00
000130414	3"	287,00
000130416	4"	519,50

Vinkel 45° nip/muf
GALVANISERET - BSPT×BSPP



Varenr.	BSPT×BSPP	DKK
000121403	3/8"	20,50
000121404	1/2"	20,50
000121406	3/4"	31,45
000121408	1"	41,90
000121410	1 1/4"	68,50
000121411	1 1/2"	82,15
000121412	2"	137,00
000121413	2 1/2"	273,50
000121414	3"	410,25
000121416	4"	682,50

Union 90° muf/muf
GALVANISERET - BSPP



Varenr.	BSPP	DKK
000096403	3/8"	68,50
000096404	1/2"	68,50
000096406	3/4"	88,45
000096408	1"	102,75
000096410	1 1/4"	143,50
000096411	1 1/2"	185,25
000096412	2"	273,50

Strøm T-stk m. muffer
GALVANISERET - BSPP



Varenr.	BSPP	DKK
000131404	1/2"	26,00
000131406	3/4"	36,40
000131408	1"	57,35
000131410	1 1/4"	86,30
000131411	1 1/2"	110,50
000131412	2"	167,25

Bøjning 180° muf/muf
GALVANISERET - BSPP



Varenr.	BSPP	DKK
000060404	1/2"	235,50
000060406	3/4"	272,00
000060408	1"	345,25
000060410	1 1/4"	413,75
000060411	1 1/2"	482,50
000060412	2"	736,50

Union 90° nip/muf
GALVANISERET - BSPT×BSPP



Varenr.	BSPT×BSPP	DKK
000098403	3/8"	75,35
000098404	1/2"	75,35
000098406	3/4"	99,35
000098408	1"	116,25
000098410	1 1/4"	164,25
000098411	1 1/2"	205,50
000098412	2"	301,25

Y-stk m. muffer
GALVANISERET - BSPP



Varenr.	BSPP	DKK
000165404	1/2"	98,85
000165406	3/4"	139,50
000165408	1"	178,50
000165410	1 1/4"	219,00
000165411	1 1/2"	244,00
000165412	2"	264,75

T-stk red. m. muffer

GALVANISERET - BSPP



Varenr.	BSPP	DKK
000130511	3/8" x 1/4" x 3/8"	23,50
000130512	3/8" x 1/2" x 3/8"	23,50
000130425	1/2" x 1/4" x 1/2"	23,50
000130519	1/2" x 3/8" x 3/8"	23,50
000130426	1/2" x 3/8" x 1/2"	23,50
000130521	1/2" x 1/2" x 3/8"	23,50
000130525	1/2" x 3/4" x 1/2"	27,95
000130527	1/2" x 1" x 1/2"	26,80
000130431	3/4" x 1/4" x 3/4"	27,95
000130432	3/4" x 3/8" x 3/4"	27,95
000130537	3/4" x 1/2" x 1/2"	27,95
000130433	3/4" x 1/2" x 3/4"	27,95
000130540	3/4" x 3/4" x 3/8"	26,80
000130541	3/4" x 3/4" x 1/2"	27,95
000130547	3/4" x 1" x 3/4"	42,90
000130441	1" x 3/8" x 1"	42,90
000130557	1" x 1/2" x 1/2"	42,90
000130442	1" x 1/2" x 1"	42,90
000130564	1" x 3/4" x 1/2"	42,90
000130566	1" x 3/4" x 3/4"	42,90
000130443	1" x 3/4" x 1"	42,90
000130570	1" x 1" x 1/2"	42,90
000130572	1" x 1" x 3/4"	42,90
000130578	1" x 1 1/4" x 1"	41,20
000130581	1" x 1 1/2" x 1"	82,15
000130448	1 1/4" x 3/8" x 1 1/4"	62,30
000130588	1 1/4" x 1/2" x 1"	64,95
000130449	1 1/4" x 1/2" x 1 1/4"	64,95
000130590	1 1/4" x 3/4" x 3/4"	64,95

000130592	1 1/4" x 3/4" x 1"	62,30
000130450	1 1/4" x 3/4" x 1 1/4"	64,95
000130597	1 1/4" x 1" x 1"	64,95
000130451	1 1/4" x 1" x 1 1/4"	64,95
000130601	1 1/4" x 1 1/4" x 3/4"	62,30
000130602	1 1/4" x 1 1/4" x 1"	64,95
000130456	1 1/2" x 1/2" x 1 1/2"	79,05
000130457	1 1/2" x 3/4" x 1 1/2"	82,15
000130621	1 1/2" x 1" x 1"	79,05
000130622	1 1/2" x 1" x 1 1/4"	82,15
000130458	1 1/2" x 1" x 1 1/2"	82,15
000130459	1 1/2" x 1 1/4" x 1 1/2"	82,15
000130463	2" x 1/2" x 2"	116,25
000130464	2" x 3/4" x 2"	116,25
000130647	2" x 1" x 1 1/2"	111,50
000130465	2" x 1" x 2"	116,25
000130466	2" x 1 1/4" x 2"	116,25
000130656	2" x 1 1/2" x 1 1/2"	162,75
000130467	2" x 1 1/2" x 2"	116,25
000130471	2 1/2" x 1" x 2 1/2"	239,25
000130472	2 1/2" x 1 1/4" x 2 1/2"	239,25
000130473	2 1/2" x 1 1/2" x 2 1/2"	239,25
000130474	2 1/2" x 2" x 2 1/2"	239,25
000130479	3" x 1 1/2" x 3"	328,75
000130481	3" x 2 1/2" x 3"	341,75
000130492	4" x 2 1/2" x 4"	607,00
000130493	4" x 3" x 4"	607,00

Kryds m. muffer

GALVANISERET - BSPP



Varenr.	BSPP	DKK
000180403	3/8"	34,40
000180404	1/2"	34,40
000180406	3/4"	47,85
000180408	1"	64,95
000180410	1 1/4"	95,80
000180411	1 1/2"	130,50
000180412	2"	178,00
000180413	2 1/2"	341,75
000180414	3"	478,75
000180416	4"	888,25

Vinkel 90° m. sideudløb

GALVANISERET - BSPP



Varenr.	BSPP	DKK
000221403	3/8"	36,35
000221404	1/2"	36,35
000221406	3/4"	41,70
000221408	1"	60,05
000221410	1 1/4"	86,05
000221411	1 1/2"	327,75
000221412	2"	396,75

T-stk m. sideudløb

GALVANISERET - BSPP



Varenr.	BSPP	DKK
000223404	1/2"	106,75
000223406	3/4"	134,50
000223408	1"	199,00

Brystnippel GALVANISERET - BSPT



Varenr.	BSPT	DKK
000280401	1/8"	13,50
000280402	1/4"	10,60
000280403	3/8"	10,60
000280404	1/2"	10,60
000280406	3/4"	13,50
000280408	1"	19,05
000280410	1 1/4"	27,95
000280411	1 1/2"	38,90
000280412	2"	53,35
000280413	2 1/2"	88,45
000280414	3"	150,75
000280416	4"	239,25

Brystnippel reduktion GALVANISERET - BSPT



Varenr.	BSPT	DKK
000245420	1/4" x 1/8"	13,50
000245421	3/8" x 1/8"	13,50
000245422	3/8" x 1/4"	13,50
000245425	1/2" x 1/4"	13,50
000245426	1/2" x 3/8"	13,50
000245432	3/4" x 3/8"	17,00
000245433	3/4" x 1/2"	17,00
000245442	1" x 1/2"	24,50
000245443	1" x 3/4"	24,50
000245449	1 1/4" x 1/2"	40,90
000245450	1 1/4" x 3/4"	40,90
000245451	1 1/4" x 1"	40,90
000245457	1 1/2" x 3/4"	51,25
000245458	1 1/2" x 1"	51,25
000245459	1 1/2" x 1 1/4"	51,25
000245465	2" x 1"	75,35
000245466	2" x 1 1/4"	75,35
000245467	2" x 1 1/2"	75,35
000245473	2 1/2" x 1 1/2"	137,00
000245474	2 1/2" x 2"	137,00
000245480	3" x 2"	233,25
000245481	3" x 2 1/2"	233,25
000245493	4" x 3"	393,00

Formmuffe GALVANISERET - BSPP



Varenr.	BSPP	DKK
000240420	1/4" x 1/8"	14,20
000240421	3/8" x 1/8"	14,80
000240422	3/8" x 1/4"	11,50
000240425	1/2" x 1/4"	11,50
000240426	1/2" x 3/8"	11,50
000240432	3/4" x 3/8"	16,45
000240433	3/4" x 1/2"	16,45
000240441	1" x 3/8"	21,95
000240442	1" x 1/2"	21,95
000240443	1" x 3/4"	21,95
000240448	1 1/4" x 3/8"	46,10
000240449	1 1/4" x 1/2"	32,40
000240450	1 1/4" x 3/4"	32,40
000240451	1 1/4" x 1"	32,40
000240456	1 1/2" x 1/2"	38,40
000240457	1 1/2" x 3/4"	38,40
000240458	1 1/2" x 1"	38,40
000240459	1 1/2" x 1 1/4"	38,40
000240463	2" x 1/2"	58,15
000240464	2" x 3/4"	58,15
000240465	2" x 1"	58,15
000240466	2" x 1 1/4"	58,15
000240467	2" x 1 1/2"	58,15
000240471	2 1/2" x 1"	109,75
000240472	2 1/2" x 1 1/4"	109,75
000240473	2 1/2" x 1 1/2"	109,75
000240474	2 1/2" x 2"	109,75
000240479	3" x 1 1/2"	171,00
000240480	3" x 2"	171,00
000240481	3" x 2 1/2"	171,00
000240491	4" x 2"	314,50
000240492	4" x 2 1/2"	314,50
000240493	4" x 3"	314,50

Nippelmuffe GALVANISERET - BSPT x BSPP

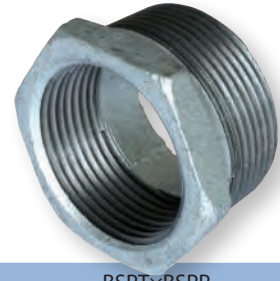

Varenr.	BSPT x BSPP	DKK
000241420	1/4" x 1/8"	10,60
000241421	3/8" x 1/8"	10,60
000241422	3/8" x 1/4"	10,60
000241425	1/2" x 1/4"	10,60
000241426	1/2" x 3/8"	10,60
000241431	3/4" x 1/4"	11,50
000241432	3/4" x 3/8"	11,50
000241433	3/4" x 1/2"	11,50
000241440	1" x 1/4"	17,00
000241441	1" x 3/8"	17,00
000241442	1" x 1/2"	17,00
000241443	1" x 3/4"	17,00
000241448	1 1/4" x 3/8"	27,40
000241449	1 1/4" x 1/2"	27,40
000241450	1 1/4" x 3/4"	27,40
000241451	1 1/4" x 1"	27,40
000241456	1 1/2" x 1/2"	32,40
000241457	1 1/2" x 3/4"	32,40
000241458	1 1/2" x 1"	32,40
000241459	1 1/2" x 1 1/4"	32,40
000241463	2" x 1/2"	44,40
000241464	2" x 3/4"	44,40
000241465	2" x 1"	44,40
000241466	2" x 1 1/4"	44,40
000241467	2" x 1 1/2"	44,40
000241471	2 1/2" x 1"	75,35
000241472	2 1/2" x 1 1/4"	75,35
000241473	2 1/2" x 1 1/2"	75,35
000241474	2 1/2" x 2"	75,35
000241477	3" x 1"	109,75
000241478	3" x 1 1/4"	109,75
000241479	3" x 1 1/2"	109,75
000241480	3" x 2"	109,75
000241481	3" x 2 1/2"	109,75
000241491	4" x 2"	205,50
000241492	4" x 2 1/2"	251,50
000241493	4" x 3"	205,50
000241496	5" x 4"	393,00

Spidsmuffe

GALVANISERET - BSPP×BSPT



Varenr.	BSPP×BSPT	DKK
000246420	1/4" × 1/8"	23,50
000246422	3/8" × 1/4"	23,50
000246425	1/2" × 1/4"	23,50
000246426	1/2" × 3/8"	23,50
000246432	3/4" × 3/8"	29,95
000246433	3/4" × 1/2"	29,95
000246442	1" × 1/2"	42,40
000246443	1" × 3/4"	42,40
000246450	1 1/4" × 3/4"	60,35
000246451	1 1/4" × 1"	60,35
000246458	1 1/2" × 1"	71,80
000246459	1 1/2" × 1 1/4"	71,80
000246466	2" × 1 1/4"	102,75
000246467	2" × 1 1/2"	102,75
000246474	2 1/2" × 2"	141,00

Muffe

GALVANISERET - BSPP



Varenr.	BSPP	DKK
000270401	1/8"	13,00
000270402	1/4"	11,00
000270403	3/8"	11,00
000270404	1/2"	10,60
000270406	3/4"	13,00
000270408	1"	21,95
000270410	1 1/4"	31,00
000270411	1 1/2"	37,40
000270412	2"	58,15
000270413	2 1/2"	102,75
000270414	3"	150,75
000270416	4"	246,25

Muffe smedet

GALVANISERET - BSPP



Varenr.	BSPP	DKK
013270406	3/4"	16,50 α
013270408	1"	23,20 α

α = så længe lager findes

Prop firkantet m. kant

GALVANISERET - BSPT



Varenr.	BSPT	DKK
000290402	1/4"	8,05
000290403	3/8"	8,05
000290404	1/2"	8,05
000290406	3/4"	10,60
000290408	1"	13,50
000290410	1 1/4"	20,50
000290411	1 1/2"	23,90
000290412	2"	34,40
000290413	2 1/2"	68,50
000290414	3"	95,80
000290416	4"	171,00

Prop firkantet u. kant

GALVANISERET - BSPT



Varenr.	BSPT	DKK
000291402	1/4"	7,65
000291403	3/8"	7,65
000291404	1/2"	7,80
000291406	3/4"	10,40
000291408	1"	11,70
000291410	1 1/4"	17,80
000291411	1 1/2"	19,85
000291412	2"	110,25
000291413	2 1/2"	98,85
000291414	3"	138,75
000291416	4"	144,00

Slutmuffe

GALVANISERET - BSPP



Varenr.	BSPP	DKK
000300402	1/4"	9,50
000300403	3/8"	9,50
000300404	1/2"	9,50
000300406	3/4"	11,50
000300408	1"	16,45
000300410	1 1/4"	23,90
000300411	1 1/2"	31,45
000300412	2"	43,85
000300413	2 1/2"	88,45
000300414	3"	123,25
000300416	4"	205,50

Kontramøtrik

GALVANISERET - BSPP



Varenr.	BSPP	DKK
000310402	1/4"	9,05
000310403	3/8"	9,05
000310404	1/2"	9,05
000310406	3/4"	9,05
000310408	1"	11,00
000310410	1 1/4"	14,55
000310411	1 1/2"	18,45
000310412	2"	28,90
000310413	2 1/2"	54,80
000310414	3"	82,15

Union konisk muf/muf

GALVANISERET - BSPP



Varenr.	BSPP	DKK
000340402	1/4"	51,25
000340403	3/8"	51,25
000340404	1/2"	51,25
000340406	3/4"	64,95
000340408	1"	75,35
000340410	1 1/4"	102,75
000340411	1 1/2"	137,00
000340412	2"	205,50
000340413	2 1/2"	341,75
000340414	3"	581,25
000340416	4"	1094,00

Union konisk nip/muf

GALVANISERET - BSPT×BSPP



Varenr.	BSPT×BSPP	DKK
000341402	1/4"	58,15
000341403	3/8"	58,15
000341404	1/2"	58,15
000341406	3/4"	75,35
000341408	1"	88,45
000341410	1 1/4"	116,25
000341411	1 1/2"	158,00
000341412	2"	233,25
000341413	2 1/2"	404,00
000341414	3"	683,75
000341416	4"	683,75

Kobling

GALVANISERET - BSPP



Varenr.	Klem	Klem	DKK
GP1-4	1/2" (21,3)	1/2" (21,3)	117,25
GP1-5	3/4" (26,9)	3/4" (26,9)	153,25
GP1-6	1" (33,7)	1" (33,7)	228,00

Muffe

GALVANISERET - BSPP



Varenr.	BSPP	Klem	DKK
GP2-4	1/2" (21,3)	1/2" (21,3)	100,25
GP2-5	3/4" (26,9)	3/4" (26,9)	118,00
GP2-6	1" (33,7)	1" (33,7)	165,50

Union flad lim/muf

U-PVC / GALVANISERET - BSPP



Varenr.	Indv. × BSPP	DKK
AL340-3	16 × 3/8"	148,25
AL340-4	20 × 1/2"	155,75
AL340-5	25 × 3/4"	177,00
AL340-6	32 × 1"	200,25
AL340-7	40 × 1 1/4"	264,50
AL340-8	50 × 1 1/2"	360,00
AL340-9	63 × 2"	544,50

Med gummipakning

Union flad lim/nip

U-PVC / GALVANISERET - BSPP



Varenr.	Indv. × BSPT	DKK
AL341-4	20 × 1/2"	178,75
AL341-5	25 × 3/4"	210,25
AL341-6	32 × 1"	241,75
AL341-7	40 × 1 1/4"	419,50
AL341-8	50 × 1 1/2"	436,25
AL341-9	63 × 2"	637,50

Med gummipakning

Nippel

GALVANISERET - BSPP



Varenr.	BSPT	Klem	DKK
GP3-4	1/2" (21,3)	1/2" (21,3)	106,50
GP3-5	3/4" (26,9)	3/4" (26,9)	138,00
GP3-6	1" (33,7)	1" (33,7)	207,50
GP3-7	1 1/4" (42,4)	1 1/4" (42,4)	370,75
GP3-8	1 1/2" (48,3)	1 1/2" (48,3)	390,50
GP3-9	2" (60,3)	2" (60,3)	614,25

Vinkel 90° med beslag

GALVANISERET - BSPP



Varenr.	BSPP	DKK
000471404	1/2"	27,95
000471406	3/4"	49,35

Forlænger

GALVANISERET - BSPP×BSPT



Varenr.	BSPP×BSPT	DKK
000529403	3/8"	20,50
000529404	1/2"	20,50
000529406	3/4"	23,90
000529408	1"	34,40
000529410	1 1/4"	47,85

Nippelrør 1/8"

GALVANISERET - BSPT



Varenr.	L	DKK
012040401	40mm	9,60
012050401	50mm	16,00
012060401	60mm	10,60

Nippelrør 3/8"

GALVANISERET - BSPT



Varenr.	L	DKK
012001403	WIW	7,10
012030403	30mm	10,60
012040403	40mm	12,00
012050403	50mm	13,10
012060403	60mm	14,55
012080403	80mm	16,05
012090403	90mm	17,55
012100403	100mm	20,00
012120403	120mm	26,00
012150403	150mm	32,40
012200403	200mm	38,90
012250403	250mm	40,40
012300403	300mm	41,90

WIW = sammenskåret

Nippelrør 3/4"

GALVANISERET - BSPT



Varenr.	L	DKK
012001406	WIW	7,20
012040406	40mm	8,55
012050406	50mm	9,65
012060406	60mm	11,00
012080406	80mm	14,55
012090406	90mm	15,85
012100406	100mm	18,05
012120406	120mm	21,55
012150406	150mm	26,95
012180406	180mm	29,95
012200406	200mm	33,00
012250406	250mm	41,45
012300406	300mm	49,35

WIW = sammenskåret

Nippelrør 1/4"

GALVANISERET - BSPT



Varenr.	L	DKK
012001402	WIW	6,75
012040402	40mm	10,00
012050402	50mm	10,25
012060402	60mm	11,50
012080402	80mm	13,00
012100402	100mm	18,05
012120402	120mm	23,50
012150402	150mm	27,95
012200402	200mm	30,50
012250402	250mm	34,40
012300402	300mm	37,95

WIW = sammenskåret

Nippelrør 1/2"

GALVANISERET - BSPT



Varenr.	L	DKK
012001404	WIW	7,30
012030404	30mm	10,00
012040404	40mm	11,00
012050404	50mm	11,95
012060404	60mm	13,00
012080404	80mm	13,50
012090404	90mm	13,05
012100404	100mm	14,10
012120404	120mm	16,45
012150404	150mm	21,00
012180404	180mm	22,95
012200404	200mm	25,50
012250404	250mm	31,95
012300404	300mm	38,40

WIW = sammenskåret

Nippelrør 1"

GALVANISERET - BSPT



Varenr.	L	DKK
012001408	WIW	18,15
012040408	40mm	19,05
012050408	50mm	20,20
012060408	60mm	22,50
012080408	80mm	23,90
012090408	90mm	25,15
012100408	100mm	27,40
012120408	120mm	33,45
012150408	150mm	41,45
012180408	180mm	45,80
012200408	200mm	50,85
012250408	250mm	63,65
012300408	300mm	76,20

WIW = sammenskåret

Nippelrør 1¼"

GALVANISERET - BSPT



Varenr.	L	DKK
012001410	WIW	22,90
012050410	50mm	25,60
012060410	60mm	27,95
012080410	80mm	31,95
012090410	90mm	30,85
012100410	100mm	33,00
012120410	120mm	39,35
012150410	150mm	49,35
012180410	180mm	53,85
012200410	200mm	59,80
012250410	250mm	74,80
012300410	300mm	89,60

WIW = sammenskåret

Nippelrør 2"

GALVANISERET - BSPT



Varenr.	L	DKK
012001412	WIW	25,55
012060412	60mm	41,80
012080412	80mm	42,40
012100412	100mm	53,35
012120412	120mm	63,65
012150412	150mm	79,75
012180412	180mm	87,10
012200412	200mm	97,20
012250412	250mm	121,25
012300412	300mm	145,50

WIW = sammenskåret

Nippelrør 3"

GALVANISERET - BSPT



Varenr.	L	DKK
012001414	WIW	62,55
012080414	80mm	71,00
012100414	100mm	88,20
012120414	120mm	106,25
012150414	150mm	132,75
012180414	180mm	145,50
012200414	200mm	161,75
012250414	250mm	201,50
012300414	300mm	242,50

WIW = sammenskåret

Nippelrør 1½"

GALVANISERET - BSPT



Varenr.	L	DKK
012001411	WIW	23,60
012050411	50mm	27,90
012060411	60mm	29,95
012080411	80mm	36,95
012100411	100mm	40,90
012120411	120mm	45,40
012150411	150mm	56,25
012180411	180mm	61,70
012200411	200mm	68,85
012250411	250mm	85,70
012300411	300mm	103,50

WIW = sammenskåret

Nippelrør 2½"

GALVANISERET - BSPT



Varenr.	L	DKK
012001413	WIW	32,50
012080413	80mm	54,35
012100413	100mm	68,00
012120413	120mm	81,10
012150413	150mm	102,00
012180413	180mm	112,00
012200413	200mm	124,00
012250413	250mm	155,25
012300413	300mm	186,00

WIW = sammenskåret

Nippelrør 4"

GALVANISERET - BSPT



Varenr.	L	DKK
012001416	WIW	131,00
012100416	100mm	129,25
012120416	120mm	154,50
012150416	150mm	193,50
012180416	180mm	212,00
012200416	200mm	236,00
012250416	250mm	294,75
012300416	300mm	353,25

WIW = sammenskåret



472

Slangenippel

GALVANISERET - BSPP



Varenr.	Ø × BSPP	L mm	DKK
LG2-4	13,5 × 1/2"	75	21,45
LG2-5	19,7 × 3/4"	77	21,95
LG2-6	26,0 × 1"	81	27,15
LG2-7	32,3 × 1 1/4"	88	30,40
LG2-8	38,7 × 1 1/2"	98	38,30
LG2-9	51,4 × 2"	108	128,25
LG2-10	64,7 × 2 1/2"	133	133,25
LG2-11	77,5 × 3"	143	149,25
LG2-12	102,8 × 4"	168	223,75
LG2-13	128,3 × 5"	233	501,50
LG2-14	153,6 × 6"	252	691,50
LG2-16	204,5 × 8"	288	883,75

Slangesamler

GALVANISERET



Varenr.	dim	L mm	DKK
LG3-4	13,5 ~ 1/2"	79,8	10,15
LG3-5	19,7 ~ 3/4"	99,8	16,10
LG3-6	26,0 ~ 1"	99,8	20,45
LG3-7	32,3 ~ 1 1/4"	99,8	29,00
LG3-8	38,7 ~ 1 1/2"	99,8	35,75
LG3-9	51,4 ~ 2"	111	44,45
LG3-10	64,7 ~ 2 1/2"	136	75,65
LG3-11	77,5 ~ 3"	146	105,25
LG3-12	102,8 ~ 4"	171	190,50
LG3-13	128,3 ~ 5"	236	297,00
LG3-14	153,6 ~ 6"	255	378,00
LG3-16	204,5 ~ 8"	291	658,00

Rørholder

ZINK



Varenr.	Ø	DKK
BR650-2	1/4"	23,05
BR650-3	3/8"	20,60
BR650-4	1/2"	19,05
BR650-5	3/4"	22,80
BR650-6	1"	25,35
BR650-7	1 1/4"	29,00
BR650-8	1 1/2"	30,70
BR650-9	2"	35,80

Forlænger

ZINK

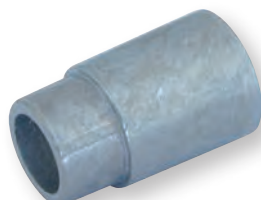

Varenr.	dim	L	DKK
BR651-1	1/2" - 2"	+ 13mm	4,43
BR651-2	1/2" - 2"	+ 16mm	4,43
BR651-3	1/2" - 2"	+ 19mm	4,43
BR651-4	1/4" - 3/8"	+ 21,5mm	4,43

Indlægsdel til BR650

PE (POLYETHYLEN)



Varenr.	Passer til:	Ø rør	DKK
BR652-12	BR650-2	12mm	5,45
BR652-15	BR650-3	15mm	5,45
BR652-18	BR650-4	18mm	5,45
BR652-22	BR650-5	22mm	5,45
BR652-28	BR650-6	28mm	5,45

GEVINDFITTINGS MESSING



Max. 30bar
(fittings m. pakning: 10bar)



-20°C til +200°C
(fittings m. pakning: 110°C)



Høj kvalitet messing rørgvind fittings
inkl. nippelrør. Fremstillet i EU under
strengt kvalitetskrav.

Vinkel 90° muf/muf

MESSING - BSPP



Varenr.	BSPP	DKK
E1560-3	3/8"	30,65
E1560-4	1/2"	32,45
E1560-5	3/4"	52,50
E1560-6	1"	91,85
E1560-7	1 1/4"	155,75
E1560-8	1 1/2"	276,50
E1560-9	2"	318,00
E1560-11	3"	1078,00
E1560-12	4"	1475,25

Vinkel 90° nip/muf

MESSING - BSPT×BSPP



Varenr.	BSPT × BSPP	DKK
E1561-3	3/8"	41,60
E1561-4	1/2"	55,55
E1561-5	3/4"	76,40
E1561-6	1"	77,55
E1561-7	1 1/4"	150,25
E1561-8	1 1/2"	189,00
E1561-9	2"	346,50

Vinkel 90° nip/nip

MESSING - BSPT



Varenr.	BSPT	DKK
E1562-3	3/8"	25,00
E1562-4	1/2"	34,90
E1562-5	3/4"	51,00

Vinkel 90° red. muf/muf

MESSING - BSPP



Varenr.	BSPP	DKK
E1560-4-3	1/2" × 3/8"	52,75
E1560-5-4	3/4" × 1/2"	65,90
E1560-6-5	1" × 3/4"	94,80
E1560-7-6	1 1/4" × 1"	232,75

Vinkel 90° muf/muf m. beslag

MESSING - BSPP



Varenr.	BSPP	DKK
E1567-4	1/2"	55,45
E1567-5	3/4"	67,20

Vinkel 90° nip/muf

MESSING - BSPP



Varenr.	BSPP	DKK
E1563-4	1/2"	33,15
E1563-5	3/4"	50,70
E1563-6	1"	76,70

T-stk m. muff

MESSING - BSPP



Varenr.	BSPP	DKK
E1570-3	3/8"	44,90
E1570-4	1/2"	34,90
E1570-5	3/4"	50,15
E1570-5-4	3/4" × 1/2" × 3/4"	52,50
E1570-6	1"	110,75
E1570-6-4	1" × 1/2" × 1"	87,45
E1570-6-5	1" × 3/4" × 1"	91,25
E1570-7	1 1/4"	167,00
E1570-8	1 1/2"	244,00
E1570-9	2"	366,50
E1570-10	2 1/2"	917,75
E1570-11	3"	1246,50
E1570-12	4"	1849,25

T-stk m. nipler

MESSING - BSPT



Varenr.	BSPT	DKK
E1572-3	3/8"	29,05
E1572-4	1/2"	37,65
E1572-5	3/4"	51,00
E1572-6	1"	87,45

T-stk muf/muf/nipl

MESSING - BSPP × BSPT



Varenr.	BSPP × BSPP × BSPT	DKK
E1511-6	1"	107,25

Stamme L=72mm

Kryds

MESSING - BSPP



Varenr.	BSPP	DKK
E1580-4	1/2"	116,50
E1580-5	3/4"	163,50
E1580-6	1"	264,75
E1580-7	1 1/4"	479,00
E1580-8	1 1/2"	508,25
E1580-9	2"	725,50

Brystnippel

MESSING - BSPT



Varenr.	BSPT	DKK
E1552-2	1/4"	8,10
E1552-3	3/8"	9,75
E1552-4	1/2"	11,95
E1552-5	3/4"	21,00
E1552-6	1"	37,65
E1552-7	1 1/4"	83,70
E1552-8	1 1/2"	97,35
E1552-9	2"	185,50
E1552-10	2 1/2"	366,50
E1552-11	3"	530,00
E1552-12	4"	858,50

Brystnippel reduktion

MESSING - BSPT



Varenr.	BSPT	DKK
E1552-3-2	3/8" × 1/4"	11,55
E1552-4-3	1/2" × 3/8"	11,40
E1552-5-4	3/4" × 1/2"	19,50
E1552-6-4	1" × 1/2"	32,20
E1552-6-5	1" × 3/4"	37,65
E1552-7-6	1 1/4" × 1"	67,05
E1552-8-7	1 1/2" × 1 1/4"	113,50
E1552-9-8	2" × 1 1/2"	218,25
E1552-10-8	2 1/2" × 1 1/2"	362,75

Rørprop sekskant

MESSING - BSPT



Varenr.	BSPT	DKK
E9-3MS	3/8"	9,35
E9-4MS	1/2"	11,80
E9-5MS	3/4"	18,35
E9-6MS	1"	33,55
E9-7MS	1 1/4"	76,20

Slutmuffe

MESSING - BSPP



Varenr.	BSPP	DKK
E1880-3	3/8"	9,45
E1880-4	1/2"	10,20
E1880-5	3/4"	16,15
E1880-6	1"	27,80
E1880-7	1 1/4"	68,85
E1880-8	1 1/2"	111,00

Forskruing m. omløber

MESSING / NBR - BSPP

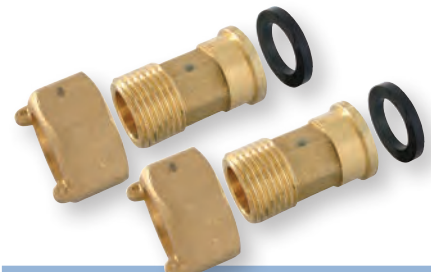

Varenr.	BSPP × BSPT	DKK/2 stk.
E1522-5	3/4" × 1/2"	60,95
E1522-6	1" × 3/4"	100,50
E1522-7	1 1/4" × 1"	167,75
E1522-8	1 1/2" × 1 1/4"	281,75
E1522-9	2" × 1 1/2"	383,25
E1522-10	2 1/2" × 2"	671,75

SORT, GALV, MESSING & ALU FITTINGS

Slangenippel m. kort gevind

MESSING - BSPP



Varenr.	Ø × BSPP	DKK
ET13-1	6 × 1/4"	11,75
ET13-2	8 × 1/4"	15,45
ET13-3	10 × 1/4"	18,25
ET13-4	10 × 3/8"	13,65
ET13-5	12 × 3/8"	17,65
ET13-6	12 × 1/2"	19,30
ET13-7	14 × 3/8"	15,30
ET13-8	14 × 1/2"	20,60
ET13-9	15 × 1/2"	30,15
ET13-10	20 × 1/2"	23,25
ET13-11	20 × 3/4"	36,15
ET13-12	25 × 3/4"	50,60
ET13-13	25 × 1"	51,80
ET13-14	30 × 1"	59,25
ET13-15	35 × 1 1/4"	70,45
ET13-16	40 × 1 1/2"	102,50
ET13-17	45 × 1 1/2"	158,00
ET13-18	50 × 2"	149,75

Slangenippel m. indv.gev.

MESSING - BSPP



Varenr.	Ø × BSPP	DKK
ET14-3	10 × 1/4"	13,00
ET14-4	10 × 3/8"	18,50
ET14-4-1	10 × 1/2"	26,25
ET14-4-2	13 × 1/2"	26,00
ET14-9	15 × 1/2"	26,00
ET14-9-1	18 × 1/2"	27,20
ET14-11	20 × 3/4"	42,40
ET14-13	25 × 1"	49,40
ET14-14	30 × 1"	59,25
ET14-14-1	30 × 1 1/4"	113,50
ET14-15	35 × 1 1/4"	116,00

Muffe

MESSING - BSPP

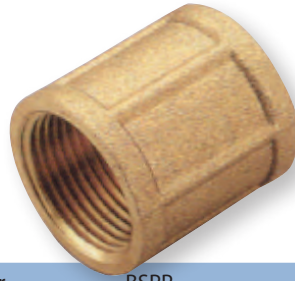

Varenr.	BSPP	DKK
E1550-3	3/8"	21,15
E1550-4	1/2"	20,35
E1550-5	3/4"	28,40
E1550-6	1"	55,55
E1550-7	1 1/4"	97,70
E1550-8	1 1/2"	134,75
E1550-9	2"	222,50
E1550-10	2 1/2"	437,25
E1550-12	4"	1075,75

Formmuffe

MESSING - BSPP



Varenr.	BSPP	DKK
E1550-4-3	1/2" × 3/8"	17,30
E1550-5-4	3/4" × 1/2"	26,20
E1550-6-4	1" × 1/2"	56,75
E1550-6-5	1" × 3/4"	56,75
E1550-7-6	1 1/4" × 1"	100,50

Kontramøtrik

MESSING - BSPP



Varenr.	BSPP	DKK
E1583-4	1/2"	11,70
E1583-5	3/4"	14,70
E1583-6	1"	17,55
E1583-7	1 1/4"	27,05
E1583-8	1 1/2"	35,55
E1583-9	2"	67,95

Reduktionsindsats

MESSING - BSPP



Varenr.	BSPP	DKK
E1582-4-3	1/2" × 3/8"	9,75
E1582-5-4	3/4" × 1/2"	14,75
E1582-6-5	1" × 3/4"	25,40

Nippelrør

MESSING - BSPT



Varenr.	BSPT	L	DKK
E1540-4-050	1/2"	50mm	23,40
E1540-4-060	1/2"	60mm	27,80
E1540-4-070	1/2"	70mm	30,65
E1540-4-080	1/2"	80mm	34,30
E1540-4-090	1/2"	90mm	37,65
E1540-4-100	1/2"	100mm	53,10
E1540-4-150	1/2"	150mm	72,90
E1540-4-200	1/2"	200mm	91,25
E1540-4-250	1/2"	250mm	115,00
E1540-5-040	3/4"	40mm	41,65
E1540-5-050	3/4"	50mm	46,70
E1540-5-060	3/4"	60mm	43,75
E1540-5-070	3/4"	70mm	62,70
E1540-5-080	3/4"	80mm	55,55
E1540-5-090	3/4"	90mm	61,85
E1540-5-100	3/4"	100mm	68,55
E1540-5-150	3/4"	150mm	120,75
E1540-5-200	3/4"	200mm	149,75
E1540-5-250	3/4"	250mm	239,25
E1540-6-050	1"	50mm	49,80
E1540-6-060	1"	60mm	58,55
E1540-6-070	1"	70mm	85,15
E1540-6-080	1"	80mm	76,10
E1540-6-090	1"	90mm	84,30
E1540-6-100	1"	100mm	92,70
E1540-6-150	1"	150mm	155,75
E1540-6-200	1"	200mm	199,25
E1540-6-250	1"	250mm	247,00

Nippelrør m. 1 langt gev.

MESSING - BSPP



Varenr.	BSPP	L	DKK
E1541-4-100	1/2"	100mm	45,30
E1541-4-150	1/2"	150mm	76,70
E1541-4-200	1/2"	200mm	104,50
E1541-5-100	3/4"	100mm	72,60
E1541-5-150	3/4"	150mm	127,50
E1541-5-200	3/4"	200mm	158,25
E1541-6-100	1"	100mm	98,55
E1541-6-150	1"	150mm	153,50
E1541-6-200	1"	200mm	214,00
E1541-6-250	1"	250mm	367,75

Spidsmuffe

MESSING - BSPP×BSPT



Varenr.	BSPP × BSPT	DKK
E1551-3	3/8"	15,30
E1551-4-3	1/2" × 3/8"	16,65
E1551-4	1/2"	16,65
E1551-5-4	3/4" × 1/2"	23,40
E1551-5	3/4"	25,70
E1551-6-5	1" × 3/4"	43,40
E1551-6	1"	54,90

Forlænger sekskantet

MESSING - BSPP



Varenr.	dim	L	DKK
E1220-4-010	1/2"	+ 10mm	10,55
E1220-4-015	1/2"	+ 15mm	11,75
E1220-4-020	1/2"	+ 20mm	14,20
E1220-4-025	1/2"	+ 25mm	18,45
E1220-4-030	1/2"	+ 30mm	19,55

Forlænger rund

MESSING - BSPP



Varenr.	dim	L	DKK
E1530-3-10	3/8"	+ 10mm	18,75
E1530-3-15	3/8"	+ 15mm	14,60
E1530-3-20	3/8"	+ 20mm	21,55
E1530-3-30	3/8"	+ 30mm	22,15
E1530-3-40	3/8"	+ 40mm	27,55
E1530-3-50	3/8"	+ 50mm	35,80
E1530-4-10	1/2"	+ 10mm	15,45
E1530-4-15	1/2"	+ 15mm	18,35
E1530-4-20	1/2"	+ 20mm	20,95
E1530-4-25	1/2"	+ 25mm	25,35
E1530-4-30	1/2"	+ 30mm	30,15
E1530-4-40	1/2"	+ 40mm	37,25
E1530-4-50	1/2"	+ 50mm	44,35
E1530-4-80	1/2"	+ 80mm	64,45
E1530-4-100	1/2"	+ 100mm	79,75
E1530-5-10	3/4"	+ 10mm	24,40
E1530-5-15	3/4"	+ 15mm	29,00
E1530-5-20	3/4"	+ 20mm	33,55
E1530-5-30	3/4"	+ 30mm	42,90
E1530-5-40	3/4"	+ 40mm	51,40
E1530-5-50	3/4"	+ 50mm	56,85
E1530-5-80	3/4"	+ 80mm	118,50
E1530-5-100	3/4"	+ 100mm	104,25
E1530-6-10	1"	+ 10mm	47,45
E1530-6-15	1"	+ 15mm	50,85
E1530-6-20	1"	+ 20mm	56,25
E1530-6-25	1"	+ 25mm	95,80
E1530-6-30	1"	+ 30mm	104,25
E1530-6-40	1"	+ 40mm	116,75
E1530-6-50	1"	+ 50mm	127,75

Nippelmuffe

MESSING - BSPP



Varenr.	BSPT × BSPP	DKK
E1581-2-1	1/4" × 1/8"	8,80
E1581-3-1	3/8" × 1/8"	10,60
E1581-3-2	3/8" × 1/4"	8,80
E1581-4-1	1/2" × 1/8"	18,00
E1581-4-2	1/2" × 1/4"	10,20
E1581-4-3	1/2" × 3/8"	9,75
E1581-5-3	3/4" × 3/8"	17,55
E1581-5-4	3/4" × 1/2"	14,45
E1581-6-2	1" × 1/4"	51,60
E1581-6-3	1" × 3/8"	36,70
E1581-6-4	1" × 1/2"	27,95
E1581-6-5	1" × 3/4"	24,30
E1581-7-5	1 1/4" × 3/4"	58,55
E1581-7-6	1 1/4" × 1"	53,10
E1581-8-5	1 1/2" × 3/4"	101,75
E1581-8-6	1 1/2" × 1"	91,00
E1581-8-7	1 1/2" × 1 1/4"	76,10
E1581-9-7	2" × 1 1/4"	125,00
E1581-9-8	2" × 1 1/2"	113,50
E1581-10-7	2 1/2" × 1 1/4"	406,25
E1581-10-8	2 1/2" × 1 1/2"	593,50
E1581-10-9	2 1/2" × 2"	472,75
E1581-11-8	3" × 1 1/2"	546,25
E1581-11-9	3" × 2"	541,00
E1581-11-10	3" × 2 1/2"	530,00
E1581-12-9	4" × 2"	662,50
E1581-12-10	4" × 2 1/2"	651,50
E1581-12-11	4" × 3"	641,50

Union muf/nip
MESSING / NBR - BSPP×BSPT



Varenr.	BSPP×BSPT	DKK
405000004	1/2"	45,70
405000006	3/4"	69,35
405000008	1"	108,25
405000010	1 1/4"	173,00
405000011	1 1/2"	346,75
405000012	2"	616,00

Union konisk muf/muf
MESSING - BSPP



Varenr.	BSPP	DKK
E1557-4	1/2"	109,00
E1557-5	3/4"	128,75
E1557-6	1"	215,00

Union 90° fornicket nip/muf
MESSING / NBR - BSPT×BSPP



Varenr.	BSPT×BSPP	DKK
405001106	3/4"	92,70
405001008-1	1"	154,50

Radiatorforskr. muf/nip
MESSING / NBR - BSPP



Varenr.	BSPP	DKK
E1555-5	3/4"	87,10
E1555-6	1"	246,50
E1555-7	1 1/4"	142,75

Union 90° nip/muf
MESSING / NBR - BSPT×BSPP

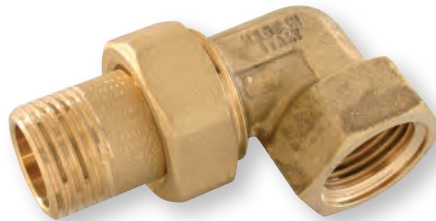

Varenr.	BSPT×BSPP	DKK
405001003	3/8"	47,45
405001004	1/2"	56,85
405001006	3/4"	88,20
405001008	1"	147,75
405001010	1 1/4"	221,50
405001011	1 1/2"	390,50
405001012	2"	837,75

Gevindrør
MESSING - BSPP



L: 96 cm ~ 106 CM

Varenr.	BSPP	DKK
E36-3	3/8"	664,50
E36-4	1/2"	765,25
E36-5	3/4"	1068,25
E36-6	1"	1355,50
E36-7	1 1/4"	1720,25
E36-8	1 1/2"	2004,50
E36-9	2"	3906,00

Union fornicket muf/nip
MESSING / NBR - BSPP×BSPT



Varenr.	BSPP×BSPT	DKK
405000103	3/8"	17,55
405000104	1/2"	39,30
405000106	3/4"	69,05
405000108	1"	108,25
405000110	1 1/4"	173,25
405000111	1 1/2"	366,00
405000112	2"	646,00

Union 90° flad nip/muf
MESSING / NBR - BSPP



Varenr.	BSPP	DKK
E1565-5	3/4"	106,75
E1565-6	1"	170,25
E1565-7	1 1/4"	585,25

Fordeler hulafstand 36mm

MESSING - BSPP



Varenr.	ind x ud	DKK
045-1975-2	3/4" x 2-1/2"	115,25
045-1975-3	3/4" x 3-1/2"	173,25
045-1975-4	3/4" x 4-1/2"	197,75
045-1975-5	3/4" x 5-1/2"	227,75
045-1975-6	3/4" x 6-1/2"	274,00
045-1975-7	3/4" x 7-1/2"	326,75
045-1975-8	3/4" x 8-1/2"	346,50
045-1975-9	3/4" x 9-1/2"	469,00
045-1975-10	3/4" x 10-1/2"	392,25
045-1975-11	3/4" x 11-1/2"	435,50
045-1975-12	3/4" x 12-1/2"	497,25
045-1976-2	1" x 2-1/2"	α
045-1976-3	1" x 3-1/2"	α
045-1976-4	1" x 4-1/2"	α
045-1976-5	1" x 5-1/2"	α
045-1976-6	1" x 6-1/2"	α
045-1976-7	1" x 7-1/2"	α
045-1976-8	1" x 8-1/2"	α
045-1976-9	1" x 9-1/2"	α
045-1976-10	1" x 10-1/2"	α
045-1976-11	1" x 11-1/2"	α
045-1976-12	1" x 12-1/2"	α

α = Leveringstid 3-4 uger for skaffevarer

Fordeler hulafstand 50mm

MESSING - BSPP



Varenr.	ind x ud	DKK
045-1985-2	3/4" x 2-1/2"	124,50
045-1985-3	3/4" x 3-1/2"	174,75
045-1985-4	3/4" x 4-1/2"	247,00
045-1985-5	3/4" x 5-1/2"	318,00
045-1985-6	3/4" x 6-1/2"	348,25
045-1985-7	3/4" x 7-1/2"	418,75
045-1985-8	3/4" x 8-1/2"	479,00
045-1985-9	3/4" x 9-1/2"	619,25
045-1985-10	3/4" x 10-1/2"	503,75
045-1985-11	3/4" x 11-1/2"	539,50
045-1985-12	3/4" x 12-1/2"	583,50
045-1986-2	1" x 2-1/2"	153,25
045-1986-3	1" x 3-1/2"	α
045-1986-4	1" x 4-1/2"	α
045-1986-5	1" x 5-1/2"	α
045-1986-6	1" x 6-1/2"	α
045-1986-7	1" x 7-1/2"	501,75
045-1986-8	1" x 8-1/2"	α
045-1986-9	1" x 9-1/2"	α
045-1986-10	1" x 10-1/2"	α
045-1986-11	1" x 11-1/2"	α
045-1986-12	1" x 12-1/2"	α

α = Leveringstid 3-4 uger for skaffevarer



Rørprop

MESSING / NBR - BSPP



Varenr.	BSPP	DKK
045-1882-4	1/2"	25,00
045-1882-5	3/4"	25,00
045-1882-6	1"	37,65
045-1882-7	1 1/4"	61,85
045-1882-8	1 1/2"	88,10
045-1882-9	2"	106,75

VARERNE TIL TIDEN OG OGSÅ DE RIGTIGE VARER TIL TIDEN

Vi forsøger konstant at udvikle vores leveringer og med mere end 1.600.000 fittings på lager, kræver det god orden og styr på tingene.

Vi har igennem de sidste år gjort store investinger i at køre vores lager så effektivt som muligt.

Vi har på nuværende tidspunkt alle fittings, ventiler og ... liggende inde i vores automatiske lagersystem, der rummer mere end 80.000 kasser med fittings.

Lad os hjælpe dig med få tingene til tiden, så du slipper for at bruge tid på restordre og lignende.

Hvis vi ved, hvad og hvor meget, du skal bruge, sikrer vi, at dine fittings konstant er på lager, således du ikke løber tør i din produktion eller til dit projekt.



GEVINDFITTINGS MESSING AFZINKNINGSBESTANDIG VA



Max. 30bar
(fittings m. pakning: 10bar)



-20°C til +200°C
(fittings m. pakning: 110°C)



Messing røgevind fittings, der ikke afgiver zink og derfor hverken forurenser det medie, der løber igennem eller tæres galvanisk.

Fremstillet i EU under strenge kvalitetskrav.

SORT, GALV, MESSING & ALU FITTINGS

Vinkel 90° muf/muf

MESSING - BSPP



Afzinkningsbestandig

Varenr.	BSPP	DKK
048090103	3/8"	42,10
048090104	1/2"	46,30
048090106	3/4"	49,20
048090108	1"	121,00
048090110	1 1/4"	215,50
048090112	2"	521,75

Vinkel 90° nip/nip

MESSING - BSPT



Afzinkningsbestandig

Varenr.	BSPT	DKK
048094106	3/4"	79,35

Brystnippel

MESSING - BSPT



Afzinkningsbestandig

Varenr.	BSPT	DKK
048280103	3/8"	16,65
048280104	1/2"	21,75
048280106	3/4"	33,90
048280108	1"	64,15
048280110	1 1/4"	120,50
048280111	1 1/2"	167,25
048280112	2"	383,25

Vinkel 90° nip/muf

MESSING - BSPP



Afzinkningsbestandig

Varenr.	BSPP	DKK
048092103	3/8"	53,45
048092104	1/2"	59,05
048092106	3/4"	100,75
048092108	1"	131,75
048092110	1 1/4"	260,75
048092111	1 1/2"	321,00
048092112	2"	509,50

T-stk m. muff

MESSING - BSPP



Afzinkningsbestandig

Varenr.	BSPP	DKK
048130103	3/8"	55,15
048130104	1/2"	49,45
048130106	3/4"	75,20
048130133	3/4" x 1/2" x 3/4"	76,70
048130108	1"	127,25
048130142	1" x 1/2" x 1"	134,00
048130143	1" x 3/4" x 1"	137,50
048130110	1 1/4"	221,50
048130111	1 1/2"	334,25
048130112	2"	414,25

Brystnippel reduktion

MESSING - BSPT



Afzinkningsbestandig

Varenr.	BSPT	DKK
048245126	1/2" x 3/8"	17,30
048245133	3/4" x 1/2"	31,70
048245142	1" x 1/2"	54,20
048245143	1" x 3/4"	58,60
048245151	1 1/4" x 1"	118,25
048245159	1 1/2" x 1 1/4"	187,50

Rørprop sekskant

MESSING - BSPT



Afzinkningsbestandig

Varenr.	BSPT	DKK
048291102	1/4"	7,40
048291103	3/8"	13,70
048291104	1/2"	17,85
048291106	3/4"	26,05
048291108	1"	53,05
048291110	1 1/4"	87,20

Muffe

MESSING - BSPP

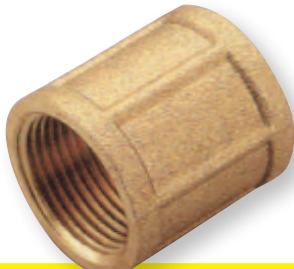

Afzinkningsbestandig

Varenr.	BSPP	DKK
048270103	3/8"	35,75
048270104	1/2"	33,30
048270106	3/4"	50,15
048270108	1"	84,30
048270110	1 1/4"	109,50
048270111	1 1/2"	207,75
048270112	2"	359,25

Formmuffe

MESSING - BSPP



Afzinkningsbestandig

Varenr.	BSPP	DKK
048240126	1/2" x 3/8"	37,10
048240133	3/4" x 1/2"	42,70
048240143	1" x 3/4"	82,80

Nippelmuffe

MESSING - BSPT x BSPP



Afzinkningsbestandig

Varenr.	BSPT x BSPP	DKK
048241122	3/8" x 1/4"	14,00
048241125	1/2" x 1/4"	16,15
048241126	1/2" x 3/8"	14,00
048241132	3/4" x 3/8"	24,15
048241133	3/4" x 1/2"	21,55
048241142	1" x 1/2"	34,50
048241143	1" x 3/4"	30,35
048241150	1 1/4" x 3/4"	82,80
048241151	1 1/4" x 1"	65,90
048241157	1 1/2" x 3/4"	117,75
048241158	1 1/2" x 1"	103,00
048241159	1 1/2" x 1 1/4"	81,35
048241166	2" x 1 1/4"	198,00
048241167	2" x 1 1/2"	138,00

Forlænger rund

MESSING - BSPP



Afzinkningsbestandig

Varenr.	dim	L	DKK
743171509	3/8"	+ 10mm	24,40
743171514	3/8"	+ 15mm	23,75
743171519	3/8"	+ 20mm	32,55
743171529	3/8"	+ 30mm	37,60
743171539	3/8"	+ 40mm	45,50
743171549	3/8"	+ 50mm	56,85
743171510	1/2"	+ 10mm	20,85
743171515	1/2"	+ 15mm	23,45
743171520	1/2"	+ 20mm	25,40
743171525	1/2"	+ 25mm	35,60
743171530	1/2"	+ 30mm	43,45
743171540	1/2"	+ 40mm	49,45
743171550	1/2"	+ 50mm	67,75
743171511	3/4"	+ 10mm	39,15
743171516	3/4"	+ 15mm	36,65
743171521	3/4"	+ 20mm	38,35
743171531	3/4"	+ 30mm	54,85
743171541	3/4"	+ 40mm	80,55
743171551	3/4"	+ 50mm	96,40

GEVINDFITTINGS BRONZE



Max 15 bar



Bronze marinefittings er markedets mest korrosionsbestandige fittings, udført i meget høj kvalitet og overholder gældende standarder for brug i både. Udført iht. standard Uni EN 1982-491K.

SORT, GALV, MESSING & ALU FITTINGS

Brystnippel BRONZE - BSPT



Varenr.	BSPT	DKK
EZ1-3	3/8"	51,10
EZ1-4	1/2"	66,60
EZ1-5	3/4"	79,20
EZ1-6	1"	130,50
EZ1-7	1 1/4"	213,75
EZ1-8	1 1/2"	244,25
EZ1-9	2"	385,75
	BSPP	
EZ1-10	2 1/2"	569,75
EZ1-11	3"	818,75
EZ1-12	4"	1489,50

Muffe BRONZE - BSPP



Varenr.	BSPP	DKK
EZ3-3	3/8"	53,45
EZ3-4	1/2"	77,00
EZ3-5	3/4"	103,75
EZ3-6	1"	154,50
EZ3-7	1 1/4"	198,75
EZ3-8	1 1/2"	257,25
EZ3-9	2"	410,50
EZ3-10	2 1/2"	719,75
EZ3-11	3"	1032,25

Vinkel 90° BRONZE - BSPP



Varenr.	BSPP	DKK
EZ5-3	3/8"	64,45
EZ5-4	1/2"	99,95
EZ5-5	3/4"	146,75
EZ5-6	1"	197,25
EZ5-7	1 1/4"	318,75
EZ5-8	1 1/2"	409,50
EZ5-9	2"	649,75
EZ5-10	2 1/2"	651,75
EZ5-11	3"	1349,50
EZ5-12	4"	2378,50

Brystnippel reduktion BRONZE - BSPT



Varenr.	BSPT	DKK
EZ2-4-3	1/2" × 3/8"	64,95
EZ2-5-4	3/4" × 1/2"	88,20
EZ2-6-5	1" × 3/4"	139,50
	BSPP	
EZ2-7-6	1 1/4" × 1"	231,00
EZ2-8-7	1 1/2" × 1 1/4"	295,50
EZ2-9-8	2" × 1 1/2"	311,00

Nippelmuffe BRONZE - BSPP



Varenr.	Ø × ø	DKK
EZ4-4-3	1/2" × 3/8"	44,60
EZ4-5-4	3/4" × 1/2"	53,45
EZ4-6-5	1" × 3/4"	83,30
EZ4-6-4	1" × 1/2"	97,20
EZ4-7-6	1 1/4" × 1"	142,75
EZ4-8-7	1 1/2" × 1 1/4"	163,00
EZ4-9-8	2" × 1 1/2"	311,00

Vinkel 90° nip/muf

BRONZE - BSPT×BSPP



Varenr.	BSPT × BSPP	DKK
EZ6-3	3/8"	63,90
EZ6-4	1/2"	101,00
EZ6-5	3/4"	141,75
EZ6-6	1"	207,75
EZ6-7	1 1/4"	304,75
EZ6-8	1 1/2"	383,75
EZ6-9	2"	619,25
BSPP		
EZ7-10	2 1/2"	1003,25
EZ7-11	3"	1313,25
EZ7-12	4"	2391,75

T-stk m. muffler

BRONZE - BSPP



Varenr.	BSPP	DKK
EZ8-3	3/8"	75,35
EZ8-4	1/2"	115,50
EZ8-5	3/4"	173,00
EZ8-6	1"	262,25
EZ8-7	1 1/4"	398,00
EZ8-8	1 1/2"	480,50
EZ8-9	2"	867,75
EZ8-10	2 1/2"	1337,00
EZ8-11	3"	1803,75
EZ8-12	4"	3151,00

Slangenippel

BRONZE - BSPP



Varenr.	Ø × BSPP	DKK
EZ9-3-10	10 × 3/8"	52,60
EZ9-4-12	12 × 1/2"	82,50
EZ9-3-13	13 × 3/8"	53,45
EZ9-4-14	14 × 1/2"	84,90
EZ9-4-16	16 × 1/2"	84,10
EZ9-5-16	16 × 3/4"	104,00
EZ9-4-19	19 × 1/2"	88,45
EZ9-5-19	19 × 3/4"	102,75
EZ9-4-20	20 × 1/2"	89,00
EZ9-5-20	20 × 3/4"	103,50
EZ9-5-25	25 × 3/4"	105,00
EZ9-6-25	25 × 1"	169,25
EZ9-6-30	30 × 1"	160,75
EZ9-7-30	30 × 1 1/4"	288,50
EZ9-6-32	32 × 1"	168,25
EZ9-7-32	32 × 1 1/4"	292,25
EZ9-7-35	35 × 1 1/4"	278,00
EZ9-7-38	38 × 1 1/4"	291,00
EZ9-8-38	38 × 1 1/2"	374,25
EZ9-7-40	40 × 1 1/4"	292,25
EZ9-8-40	40 × 1 1/2"	378,00
EZ9-8-45	45 × 1 1/2"	353,00
EZ9-8-50	50 × 1 1/2"	369,00
EZ9-9-50	50 × 2"	586,25
EZ9-9-60	60 × 2"	533,00

Skotgennemføring

BRONZE - BSPP



Varenr.	BSPP	Ext. dim	DKK
EZ10-3	3/8"	18	243,00
EZ10-4	1/2"	22	250,50
EZ10-5	3/4"	27	312,25
EZ10-6	1"	34	450,50
EZ10-7	1 1/4"	43	627,75
EZ10-8	1 1/2"	49	749,50
EZ10-9	2"	61	987,50
EZ10-10	2 1/2"	77	1987,00
EZ10-11	3"	89	2747,25
EZ10-12	4"	115	4370,50
EZ10-13	5"	140	8250,50

Kontramøtrik

BRONZE - BSPP



Varenr.	BSPP	DKK
EZ11-6	1"	167,00
EZ11-7	1 1/4"	213,75
EZ11-8	1 1/2"	253,00
EZ11-9	2"	358,75
EZ11-10	2 1/2"	517,25
EZ11-11	3"	625,25

Kuglehane FB

BRONZE / PTFE (TEFLON) - BSPP



Varenr.	BSPP	DKK
EZ12-2	1/4"	353,25
EZ12-3	3/8"	356,25
EZ12-4	1/2"	361,00
EZ12-5	3/4"	461,75
EZ12-6	1"	705,75
EZ12-7	1 1/4"	1178,50
EZ12-8	1 1/2"	1452,50
EZ12-9	2"	2658,50
EZ12-10	2 1/2"	3473,25
EZ12-11	3"	6089,50
EZ12-12	4"	10439,25

GEVINDFITTINGS SORT ALU



Anodiseret aluminium fittings i høj kvalitet.

Anodisering af aluminium er en elektrokemisk proces, hvor man forøger tykkelsen af det naturlige, gennemsigtige oxidlag, hvorved der dannes et porøst oxidlag som en integreret del af aluminiumets overflade.

Formålet med anodisering:

1. At forbedre korrosionsbestandigheden.
2. At gøre overfladen hård og derved øge modstanden mod mekanisk slid.
3. At skabe en elektrisk isolerende overflade.
4. At frembringe en dekorativ overflade (eks. indfarvning).

T-stk m. muffer

SORT ANODISERET ALUMINIUM - BSPP



Varenr.	BSPP	DKK
DA32-7	1 1/4"	270,00
DA32-8	1 1/2"	314,25
DA32-9	2"	444,00
DA32-10	2 1/2"	639,75
DA32-11	3"	799,50
DA32-12	4"	1213,50
DA32-13	5"	1844,75

Brystnippel

SORT ANODISERET ALUMINIUM - BSPT



Varenr.	BSPT	NV	DKK
DA39-7	1 1/4"	46	173,25
DA39-8	1 1/2"	52	224,75
DA39-9	2"	65	228,75
DA39-10	2 1/2"	80	271,00
DA39-11	3"	93	348,25
DA39-12	4"	122	589,25
DA39-13	5"	148	846,75

NV = nøglevidde

Vinkel 90°

SORT ANODISERET ALUMINIUM - BSPP



Varenr.	BSPP	DKK
DA31-7	1 1/4"	241,25
DA31-8	1 1/2"	282,75
DA31-9	2"	406,00
DA31-10	2 1/2"	516,75
DA31-11	3"	641,75
DA31-12	4"	1008,25

Slangenippel

SORT ANODISERET ALUMINIUM - BSPP



Varenr.	Ø × BSPP	L mm	NV	DKK
DA30-6-25	25 × 1"	56,5	35	139,25
DA30-6-30	30 × 1"	56,5	35	140,25
DA30-6-32	32 × 1"	62,5	35	142,25
DA30-7-32	32 × 1 1/4"	65	46	192,75
DA30-7-35	35 × 1 1/4"	65	46	193,75
DA30-7-38	38 × 1 1/4"	65	46	202,00
DA30-7-40	40 × 1 1/4"	65	46	203,00
DA30-8-38	38 × 1 1/2"	68	52	239,00
DA30-8-40	40 × 1 1/2"	68	52	240,00
DA30-8-45	45 × 1 1/2"	74	52	243,25
DA30-8-50	50 × 1 1/2"	74	52	244,25
DA30-9-50	50 × 2"	75	65	308,00
DA30-9-60	60 × 2"	75	65	327,75
DA30-10-60	60 × 2 1/2"	78	80	435,75
DA30-10-63	63 × 2 1/2"	78	80	439,00
DA30-10-65	65 × 2 1/2"	78	80	482,25
DA30-10-70	70 × 2 1/2"	86	80	485,25
DA30-11-76	76 × 3"	97	93	516,25
DA30-11-80	80 × 3"	97	93	519,25
DA30-12-100	100 × 4"	116	122	701,50
DA30-13-125	125 × 5"	138	148	1242,25

NV = nøglevidde

Muffe

SORT ANODISERET ALUMINIUM - BSPP



Varenr.	BSPP	DKK
DA33-7	1 1/4"	181,50
DA33-8	1 1/2"	219,50
DA33-9	2"	230,75
DA33-10	2 1/2"	289,50
DA33-11	3"	390,50

Vinkel 90° nip/muf

SORT ANODISERET ALUMINIUM - BSPT×BSPP



Varenr.	BSPT × BSPP	DKK
DA34-7	1 1/4"	239,00
DA34-8	1 1/2"	276,75
DA34-9	2"	384,25
DA34-10	2 1/2"	474,00
DA34-11	3"	610,00
DA34-12	4"	994,00
DA34-13	5"	1409,25

SPULEUDSTYR



584 INDUSTRIPISTOLER



590 SVIVELER



592 NITO KOBLINGER



594 SPULEUDSTYR
TILBEHØR

INDUSTRIPISTOLER



Max. 24bar



Max. 95°C



Denne gennemførte serie af spulepistoler til mange forskellige formål og sviveler til at komplettere de forskellige installationer er meget omfattende. Tjek serien og se dine muligheder.

Industripistol økonomisk

MESSING / RUSTFRI - 1/2" BSPP



Dysen har et fladt design, som giver et perfekt sprøjtemønster uden at dryppe. Dyse spidsen er præcis og giver en meget lige fordeling af vand. Udløserens form gør det nemt at skifte fra en bred kegle til et smalt punkt. Desuden er åbningen dimensioneret således, at pistolen bruger 26% mindre vand end en regulær rengøringspistol. Den har også en stor rengøring magt ved sin stærke stråle. På trods af sin lave vægt og kompakte dimensioner, er pistolen ekstremt holdbar takket være dens robuste konstruktion med robuste hængselled, holdbare materialer og dobbelte interne pakninger. Det gør den til en af de mest økonomiske dyser på markedet med en fremragende pris / kvalitet.

Varenr.	BSPP	DKK
N20-1	1/2"	657,25

Industripistol ergonomisk

MESSING / RUSTFRI - 1/2" BSPP



N21 giver et uovertruffet sprøjtemønster. Aftrækkerens udformning med mulighed for at stille på skruen bagtil, som udgør en præcis justering af sprøjtemønsteret. Let og nemt justeres dysen, uden brug af værktøj. Dysens flade design, forhindrer drypning under sprøjtning, selv med brug af den bredeste stråle. Desuden er åbningen dimensioneret således, at pistolen bruger 16% mindre vand end en regelær rengøring pistol. På grund af sin robuste konstruktion, robuste hængselled, holdbare materialer og dobbelte interne pakninger, er du sikker på en meget lang og problemfri levetid.

Varenr.	BSPP	DKK
N21-1	1/2"	1031,25

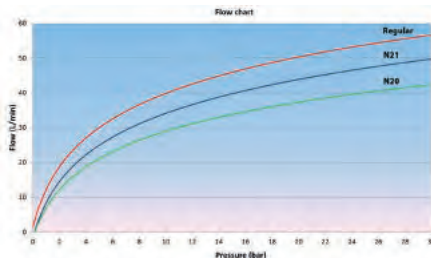

Industripistol

MESSING - 1/2" BSPP



Industripistol lavet af messing indstøbt i EPDM. Uden bøjle. Ikke-isoleret aftrækker. Max 24 bar, max 95°C.

Varenr.	BSPP	Farve	DKK
744841324	1/2"	BLÅ	773,00
744841324-2	1/2"	SORT	773,00
744841324-3	1/2"	RØD	773,00
744841324-4	1/2"	GRØN	773,00
744841324-5	1/2"	GUL	773,00
744841324-6	1/2"	HVID	773,00

Industripistol

MESSING - 1/2" BSPP



Industripistol lavet af messing indstøbt i blå EPDM. Uden bøjle. Isoleret aftrækker. Max 24 bar, max 95°C.

Varenr.	BSPP	DKK
N1-1	1/2"	827,25

Industripistol MESSING - 1/2" BSPP



Industripistol lavet af messing indstøbt i blå EPDM. Med bøjle. Isoleret aftrækker. Max 24 bar, max 95°C.

Varenr.	BSPP	DKK
N1-2	1/2"	887,75

Industripistol AISI 316 / EPDM - 1/2" BSPP



Industripistol lavet af rustfri syrefast stål indstøbt i blå EPDM. Uden bøjle. Isoleret aftrækker. Max 24 bar, max 95°C.

Varenr.	BSPP	DKK
N2-1	1/2"	2370,25

Industripistol STERILISERBAR AISI 316 - 1/2" BSPP



Lavet af rustfri syrefast stål indstøbt i specialgummi. Uden bøjle. Ikke-isoleret aftrækker. Kan steriliseres (op til 160°C). Max 24 bar. Til brug i farmaceutisk og fødevarer industri.

Varenr.	BSPP	DKK
N3-1	1/2"	3391,00

Industripistol BIG FLOW MESSING - 1/2" BSPP



Industripistol lavet af messing indstøbt i sort EPDM. Uden bøjle. Isoleret aftrækker. Max 24 bar, max 95°C.

Op til 120L/min		
Varenr.	BSPP	DKK
N1-3	1/2"	854,75

Industripistol AISI 316 / EPDM - 1/2" BSPP



Industripistol lavet af rustfri syrefast stål indstøbt i blå EPDM. Med bøjle. Isoleret aftrækker. Max 24 bar, max 95°C.

Varenr.	BSPP	DKK
N2-2	1/2"	2443,25

Industripistol EXPLOSIONSIKKER AISI 316 / EPDM - 1/2" BSPP



Industripistol lavet af rustfri syrefast stål indstøbt i sort EPDM. Med bøjle. Isoleret aftrækker. Max 24 bar, max 60°C.

Eksplosionsikker zone 1 + 2		
Varenr.	BSPP	DKK
N4-1	1/2"	3055,00

Industripistol BIG FLOW MESSING - 1/2" BSPP



Industripistol lavet af messing indstøbt i sort EPDM. Med bøjle. Isoleret aftrækker. Max 24 bar, max 95°C.

Op til 120L/min		
Varenr.	BSPP	DKK
N1-4	1/2"	920,75

Industripistol AISI 316 / EPDM - 1/2" BSPP



Industripistol lavet af rustfri syrefast stål indstøbt i hvid EPDM. Med bøjle. Isoleret aftrækker. Max 24 bar, max 95°C.

Varenr.	BSPP	DKK
N2-3	1/2"	2443,25

Industripistol HOT WATER AISI 316 / EPDM - 1/2" BSPP



Lavet af rustfri syrefast stål indstøbt i rød EPDM. Med bøjle. Isoleret aftrækker. Håndtag m. teflon/luft isolering, så varme-påvirkningen minimeres. Max 24 bar, max 95°C.

Varenr.	BSPP	DKK
N5-1	1/2"	2718,25

Industripistol HOT water, BIG flow



AISI 316 / EPDM - 1/2" BSPP
Lavet af rustfri syrefast stål indstøbt i rød EPDM. Med bøjle. Isoleret aftrækker. Håndtag m. teflon/luft isolering, så varme-påvirkningen minimeres. Max 24 bar, max 95°C.

Op til 120L/min

Varenr.	BSPP	DKK
N5-2	1/2"	2718,25

Industripistol HOT WATER

AISI 316 / EPDM - 1/2" BSPP



Lavet af rustfri syrefast stål indstøbt i rød EPDM. Med bøjle. Isoleret aftrækker. Håndtag m. teflon/luft isolering, så varme-påvirkningen minimeres. Max 24 bar, max 95°C.

Lang version m. 2 greb

Varenr.	BSPP	DKK
N5-3	1/2"	4240,75

Industripistol BIG FLOW

AISI 316 / EPDM - 1/2" BSPP



Industripistol lavet af rustfri syrefast stål indstøbt i sort EPDM. Uden bøjle. Isoleret aftrækker. Max 24 bar, max 95°C.

Op til 120L/min

Varenr.	BSPP	DKK
N6-1	1/2"	2509,25

Skumpistol m. LYNKOBLING

AISI 316 / EPDM - 1/2" BSPP



Skumpistol lavet af rustfri syrefast stål indstøbt i blå EPDM. Uden bøjle. Isoleret aftrækker. Max 20bar, max 95°C.

Lynkobling til lanse eller dyse

Varenr.	BSPP	DKK
N7-1	1/2"	3330,00

Skumpistol m. LYNKOBLING

MESSING - 1/2" BSPP



Skumpistol lavet af messing indstøbt i blå EPDM. Uden bøjle. Ikke-isoleret aftrækker. Max 20bar, max 95°C.

Lynkobling til lanse eller dyse

Varenr.	BSPP	DKK
N8-1	1/2"	1539,00

Skumpistol m. SPREDER

FDA - 1/2" BSPP



Letvægts skumpistol lavet af glasfiber indstøbt i blå EPDM. Uden bøjle. Ikke-isoleret aftrækker. Max 12bar, max 50°C.

Varenr.	BSPP	DKK
N9-1	1/2"	1565,75

Skumdyse

AISI 316 / NYLON



Skumdyse lavet af rustfri syrefast stål med nylon beskyttelse af dysen.

Varenr.	Evt.	DKK
N10-1	-	440,25

Skumdyse

AISI 316



Skumdyse lavet af rustfri syrefast stål med gummi beskyttelse af dysen.

Varenr.	Evt.	DKK
N10-4	-	336,50

Skumlanse 22cm

AISI 316



Skumlanse lavet af rustfri syrefast stål med nylon beskyttelse af dysen.

Varenr.	Evt.	DKK
N10-2	-	579,00

Skumlanse 50cm

AISI 316



Skumlanse lavet af rustfri syrefast stål med nylon beskyttelse af dysen.

Varenr.	Evt.	DKK
N10-3	-	601,25

Skumlanse 50cm

AISI 316



Skumlanse lavet af rustfri syrefast stål med gummi beskyttelse af dysen.

Varenr.	Evt.	DKK
N10-5	-	529,25

Sprayhoved

MESSING - 1/2" BSPP



Sprayhoved lavet af messing indstøbt i EPDM. Strålemønster justerbart og kan lukkes helt.

Max 16 bar, max 80°C.

Ikke til damp.

Varenr.	BSPP	Farve	DKK
N11-1	1/2"	blå/sort	1317,50
N11-2	1/2"	rød/sort	1317,50
N11-3	1/2"	hvid/sort	1317,50

Sprayhoved

AISI 316 / EPDM - 1/2" BSPP



Sprayhoved lavet af rustfri syrefast stål indstøbt i EPDM. Strålemønster justerbart og kan lukkes helt.

Max 16 bar, max 80°C.

Ikke til damp.

Varenr.	BSPP	Farve	DKK
N11-4	1/2"	blå/sort	1516,25
N11-5	1/2"	rød/sort	1516,25
N11-6	1/2"	hvid/sort	1516,25
N11-7	1/2"	HVID/HVID	1543,00

Letvægts sprayhoved

MESSING - 3/4" BSPP



Letvægts sprayhoved lavet af messing indstøbt i EPDM. Vejer kun 260 gram. Strålemønster justerbart og kan lukkes helt.

Max 16 bar, max 80°C.

Ikke til damp.

Varenr.	BSPP	Farve	DKK
N19-1	3/4"	BLÅ	1207,25

Vandsparedeyse

MESSING - 3/4" BSPP



Vandsparedeyse lavet af messing og gummi. Lukker kun vand ud, når der trykkes på gummienden.

Til almindeligt vandtryk, max 100°C, 65°C kontinuert.

Varenr.	BSPP	DKK
N12-1	3/4"	887,75

Vandsparedeyse

AISI 316 - 3/4" BSPP



Vandsparedeyse lavet af rustfri syrefast stål og gummi. Lukker kun vand ud, når der trykkes på gummienden.

Til almindeligt vandtryk, max 100°C, 65°C kontinuert.

Varenr.	BSPP	DKK
N12-2	3/4"	3576,25

Vandsparedeyse

MESSING - 3/4" BSPP



Vandsparedeyse lavet af messing og gummi. Lukker kun vand ud, når der trykkes på gummienden.

Til almindeligt vandtryk, max 65°C.

Max 10 bar		
Varenr.	BSPP	DKK
N12-3	3/4"	641,00

Højtrykspistol m. LYNKOBLING

MESSING - 3/8" BSPP



Højtryk vandpistol lavet af messing indstøbt i sort plast. Plast aftrækker. Med bøjle.
Max 310 bar, max 150°C.

310 bar m. lynkobling til lanse

Varenr.	BSPP	DKK
N13-1	3/8"	1119,75

Højtrykslanse 70cm

AISI 316



Højtrykslanse lavet af syrefast rustfri stål, med håndtag af plast.
Max 280 bar, max 150°C

Varenr.	Evt.	DKK
N13-2	-	799,75

Højtrykslanse 90cm

AISI 316



Højtrykslanse lavet af syrefast rustfri stål, med håndtag af plast.
Max 280 bar, max 150°C

Varenr.	Evt.	DKK
N13-3	-	854,75

HJÆLP OS MED AT UDVIKLE ROYKON A/S

Vi har brug for din hjælp til at udvikle os i den rigtige retning.

Hvis du har ideer til nye produkter eller du kender en, der kan bruge vores produkter, så vent ikke med at henvende dig til os. Vi elsker nye udfordringer med hensyn til nye produkter og hvis du kunne tænke dig, at vi havde et bestemt produkt i vores program, så skriv eller ring til os.

Vi sender også gerne vores katalog til en person, som du mener burde have det. Du er selvfølgelig også velkommen til at rekvirere flere kataloger til jeres virksomhed, hellere et for meget end et for lidt.



SVIVELER



Her er der tale om en serie af svivel, som passer perfekt til spulepistolerne. Fås i rustfri stål og messing og alle med kuglelejer.

Kugleleje svivel nip/muf

MESSING / EPDM - 1/2"×1/2" BSPP



Max 30 bar

Varenr.	BSPP	Lysning	DKK
N14-1	1/2"×1/2"	9mm	231,50

Kugleleje svivel nip/nip

MESSING / EPDM - 1/2" BSPP×3/4" BSPT

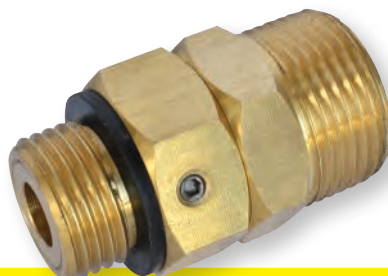

Max 30 bar

Varenr.	BSPP×BSPT	Lysning	DKK
N14-4	1/2"×3/4"	9mm	235,25

Kugleleje svivel nip/muf

MESSING / EPDM - 1"×1" BSPP



Max 30 bar

Varenr.	BSPP	Lysning	DKK
N14-7	1"×1"	18mm	435,75

Kugleleje svivel nip/muf

MESSING / EPDM - 1/2"×3/4" BSPP

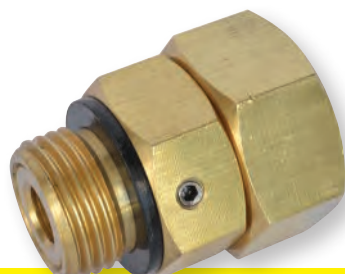

Max 30 bar

Varenr.	BSPP	Lysning	DKK
N14-2	1/2"×3/4"	9mm	237,25

Kugleleje svivel nip/muf

MESSING / EPDM - 3/4"×3/4" BSPP

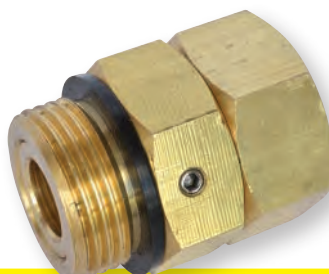

Max 30 bar

Varenr.	BSPP	Lysning	DKK
N14-5	3/4"×3/4"	12mm	288,00

Kugleleje svivel nip/muf

MESSING / EPDM - BSPP



Max 30 bar

Varenr.	BSPP	Lysning	DKK
N15-1	1/2"×1/2"	9mm	297,75
N15-2	1/2"×3/4"	9mm	294,75

Kugleleje svivel nip/nip

MESSING / EPDM - 1/2"×1/2" BSPP



Max 30 bar

Varenr.	BSPP	Lysning	DKK
N14-3	1/2"×1/2"	9mm	237,25

Kugleleje svivel nip/muf

MESSING / EPDM - 1/2"×3/4" BSPP



Max 30 bar

Varenr.	BSPP	Lysning	DKK
N14-6	1/2"×3/4"	14mm	253,75

Kugleleje svivel nip/muf

AISI 316 / VITON - 1/2"×1/2" BSPP

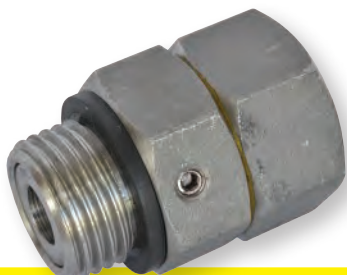

Max 30 bar

Varenr.	BSPP	Lysning	DKK
N16-1	1/2"×1/2"	9mm	458,00

Kugleleje svivel nip/muf

AISI 316 / VITON - 3/4"×3/4" BSPP

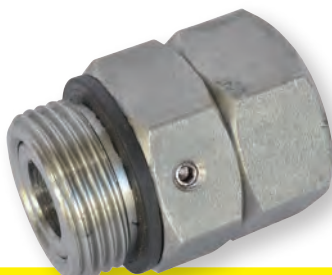

Max 30 bar

Varenr.	BSPP	Lysning	DKK
N16-5	3/4"×3/4"	12mm	567,25

Kugleleje svivel nip/muf

AISI 316 / VITON - 1/2"×3/4" BSPP

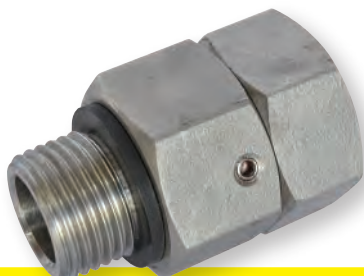

Max 30 bar

Varenr.	BSPP	Lysning	DKK
N16-2	1/2"×3/4"	9mm	463,25

Kugleleje svivel nip/muf

AISI 316 / VITON - 1/2"×3/4" BSPP

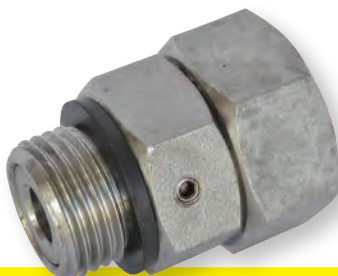

Max 30 bar

Varenr.	BSPP	Lysning	DKK
N16-6	1/2"×3/4"	14mm	488,25

Kugleleje svivel nip/nip

AISI 316 / VITON - 1/2"×1/2" BSPP

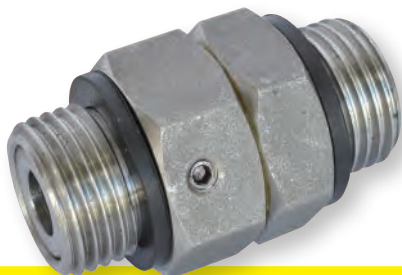

Max 30 bar

Varenr.	BSPP	Lysning	DKK
N16-3	1/2"×1/2"	9mm	471,00

Kugleleje svivel nip/muf

AISI 316 / VITON - 1"×1" BSPP

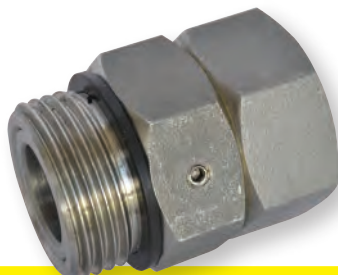

Max 30 bar

Varenr.	BSPP	Lysning	DKK
N16-7	1"×1"	18mm	737,75

Kugleleje svivel nip/nip

AISI 316 / VITON - 1/2" BSPP×3/4" BSPT

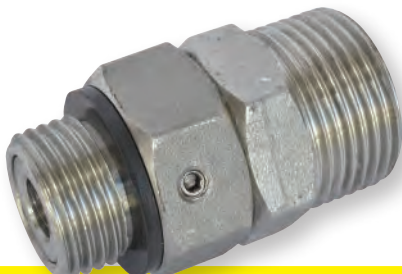

Max 30 bar

Varenr.	BSPP×BSPT	Lysning	DKK
N16-4	1/2"×3/4"	9mm	471,50

NiTO KOBLINGER



25 bar



-30°C til +80°C



NiTO er produceret med meget høj kvalitet og er et program med fantastisk stabilitet.

NiTO kobling m. udv. gevind

MESSING - BSPP



Varenr.	BSPP × NiTO	DKK
744809004	1/2" × 1/2"	137,00

NiTO kobling m. slangestuds

MESSING



Varenr.	Ø × NiTO	DKK
744808004	1/2" × 1/2"	110,75

NiTO nippel m. indv. gevind

MESSING - BSPP



Varenr.	MM × NiTO	DKK
744816022	M22*1 × 1/2"	43,40

NiTO kobling m. udv. gevind

MESSING - BSPP



Varenr.	BSPP × NiTO	DKK
744809036	3/4" × 1/2"	137,00

NiTO kobling m. slangestuds

MESSING



Varenr.	Ø × NiTO	DKK
744808006	3/4" × 1/2"	126,50

NiTO nippel m. indv. gevind

MESSING - BSPP



Varenr.	BSPP × NiTO	DKK
744816006	3/4" × 1/2"	62,30

NiTO kobling m. indv. gevind

MESSING - BSPP



Varenr.	BSPP × NiTO	DKK
744810004	1/2" × 1/2"	113,25

NiTO nippel m. udv. gevind

MESSING - BSPP



Varenr.	BSPP × NiTO	DKK
744818004	1/2" × 1/2"	43,10

NiTO nippel m. slangestuds

MESSING



Varenr.	Ø × NiTO	DKK
744812003	3/8" × 1/2"	49,85

NiTO kobling m. multigevind

MESSING - BSPP



Varenr.	BSPP × NiTO	DKK
744811006	Multi × 1/2"	165,00

Multi = 1/2"+3/4"+M22*1

NiTO nippel m. indv. gevind

MESSING - BSPP



Varenr.	BSPP × NiTO	DKK
744816004	1/2" × 1/2"	49,85

NiTO nippel m. slangestuds

MESSING



Varenr.	Ø × NiTO	DKK
744812004	1/2" × 1/2"	45,55

NiTO nippel m. slangestuds
MESSING



Varenr.	Ø × NiTO	DKK
744812024	3/4" × 1/2"	54,85

NiTO nippel m. indiv. gevind
MESSING - BSPP



Varenr.	BSPP × NiTO	DKK
744816034	1/2" × 3/4"	68,50

NiTO 1/2" startsæt
1/2" BSPP



NiTO 1" pistol med 1/2" NiTO nippel tilslutning og 1/2" NiTO kobling afgang + 1/2" NiTO kobling med slangestuds + 1/2" NiTO nippel med dyse + spændebånd

Varenr.	Ø	DKK
744850050	-	649,25

NiTO kobling m. indiv. gevind
MESSING - BSPP



Varenr.	BSPP × NiTO	DKK
744810006	3/4" × 1/2"	127,50
744810036	3/4" × 3/4"	125,50

NiTO nippel m. indiv. gevind
MESSING - BSPP



Varenr.	BSPP × NiTO	DKK
744816036	3/4" × 3/4"	84,10

NiTO kobling m. slangestuds
MESSING



Varenr.	Ø × NiTO	DKK
744808036	3/4" × 3/4"	164,75

NiTO nippel m. slangestuds
MESSING



Varenr.	Ø × NiTO	DKK
744812034	1/2" × 3/4"	62,80

NiTO adapter
MESSING - BSPP×MM



Varenr.	BSPP × mm	DKK
744950004	1/2" × M22*1	42,55

NiTO nippel m. udv. gevind
MESSING - BSPP



Varenr.	BSPP × NiTO	DKK
744818036	3/4" × 3/4"	73,15

NiTO nippel m. slangestuds
MESSING



Varenr.	Ø × NiTO	DKK
744812036	3/4" × 3/4"	56,25

NiTO adapter
MESSING - BSPP×MM

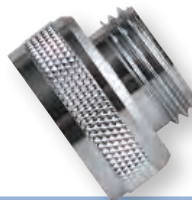

Varenr.	BSPP × mm	DKK
744950006	3/4" × M22*1	50,60

NiTO nippel m. udv. gevind
MESSING / NBR - BSPP



Varenr.	BSPP × NiTO	DKK
744818056	3/4" × 3/4"	80,55

NiTO adapter
MESSING - MM×BSPP

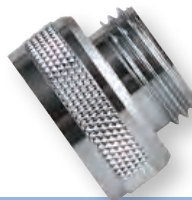

Varenr.	mm × BSPP	DKK
744950022	M22*1 × 1/2"	42,00

SPULEUDSTYR TILBEHØR



Slangebeskytter GUMMI



Varenr.	Max slange Ø	Farve	DKK
N17-1	20,5mm	BLÅ	71,00
N17-2	20,5mm	RØD	71,00
N17-3	21mm	BLÅ	115,25
N17-4	21mm	RED	115,25
N17-5	22,5mm	BLÅ	71,00
N17-6	23mm	BLÅ	115,25
N17-7	23mm	GRØN	115,25
N17-8	23mm	RØD	115,25
N17-9	23mm	GUL	115,25
N17-10	31mm	BLÅ	158,25
N17-11	31mm	RØD	158,25
N17-12	31mm	GUL	149,25

Slangeholder AISI 304



40m 1/2" eller 30m 3/4"		
Varenr.	Evt.	DKK
N18-1	-	1157,75

Slangeholder AISI 304

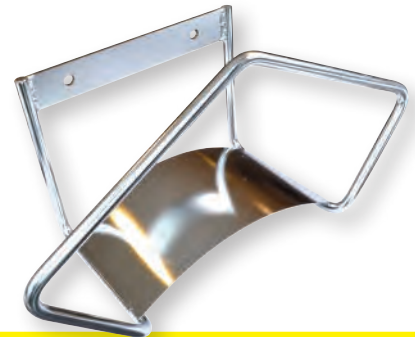

25m 1/2" eller 20m 3/4"		
Varenr.	Evt.	DKK
N18-2	-	769,75

SPÆNDEBÅND



596

SPÆNDERINGE



599

SPÆNDEBÅND



605

TILBEHØR TIL
SPÆNDEBÅND

SPÆNDERINGE



Bredt program af spændebånd, både almindelige og rustfri. Der er flere serier, delt op i tryktrin: lavtryk, mellemtryk og højtryk.

Overholder RoHS-direktivet.

1-øre spændering

STÅL



1-øre spænderinge er en økonomisk løsning for mange simple slanger, der bruges til luft eller væsker. Kanterne er afrundede og øret er udformet således, at når ringen er monteret, klemmer den slangen sikkert og vedvarende.

1-øre spændering

AISI 304



1-øre spænderinge er en økonomisk løsning for mange simple slanger til luft eller væsker. Denne model, af AISI 304 stål, er korrosionsbestandig og anbefales navnlig til udendørs applikationer. Øret er udformet således, at når ringen er monteret, klemmer den slangen sikkert og vedvarende.

1-øre spændering

STÅL



1-øre spænderinge er en økonomisk løsning for mange simple slanger, der bruges til luft eller væsker. Inderringen gør, at spænderingen passer stramt omkring slangen og beskytter slangen mod at blive klemt under montering. Et-øre spændering med inderring anbefales, når man arbejder med finere slanger.

Lavtryk

Varenr.	Ø	-	DKK
JB23-0	7-9	6	2,04
JB23-1	8-10	6	2,04
JB23-2	9-11	6,5	2,04
JB23-3	10-12	6,5	2,33
JB23-4	11-13	6,5	2,43
JB23-5	12-14	7	2,55
JB23-6	14-16	7	3,02
JB23-7	16-18	7	3,02

Lavtryk

Varenr.	Ø	-	DKK
JB23R-1	7-9	6	3,57
JB23R-2	8-10	6	4,10
JB23R-3	9-11	6,5	4,38
JB23R-4	10-12	6,5	4,77
JB23R-5	11-13	6,5	5,00
JB23R-6	12-14	7	5,60
JB23R-7	13-15	7	5,75
JB23R-8	14-16	7	5,85
JB23R-9	15-17	7	5,85
JB23R-10	16-18	7	6,05
JB23R-11	17-19	7,5	6,35
JB23R-12	18-20	7,5	6,80

Lavtryk m. inderring

Varenr.	Ø	-	DKK
JB24-1	8-9,5	6	3,69
JB24-2	9-10,5	6,5	3,69
JB24-3	10-11,5	6,5	3,69
JB24-4	10,5-12,5	6,5	3,80
JB24-5	11,5-13,3	7	4,20
JB24-6	13-15,3	7	5,00
JB24-7	15-17,3	7	5,15



Et-øre spændering

AISI 304



Et-øre spænderinge er en økonomisk løsning for mange simple slanger, der bruges til luft eller væsker. Inderringen gør, at spænderingen passer stramt omkring slangen og beskytter slangen mod at blive klemt under montering. Denne version, af AISI 304 stål, er korrosionsbestandig og anbefales især til udendørs og marine applikationer.

Lavtryk m. inderring			
Varenr.	Ø	-	DKK
JB24R-1	7,5-8,5	6	5,00
JB24R-2	8,2-9,5	6	5,25
JB24R-3	9-10,5	6,5	6,05
JB24R-5	10,5-12,5	6,5	6,70
JB24R-6	11,5-13,5	7	7,50
JB24R-7	12,5-14,5	7	7,60
JB24R-8	13-15,3	7	7,90
JB24R-9	14-16,3	7	8,05
JB24R-10	15-17,3	7	8,10
JB24R-11	16-18,3	7,5	8,75
JB24R-12	17-19,3	7,5	9,25

2-øre spændering

STÅL



2-øre spænderinge er en økonomisk og alsidig løsning for mange simple slangeforbindelser til luft eller væsker. Kanterne er afrundede og to ører giver ekstra greb, sikrer et konstant tryk om slangen og gør montering mere fleksibel og præcis.

Lavtryk			
Varenr.	Ø	-	DKK
JB22-0	5-7	6	2,21
JB22-1	7-9	6	2,33
JB22-2	9-11	6,5	2,33
JB22-3	10-12	6,5	2,33
JB22-4	11-13	6,5	2,33
JB22-5	13-15	7	2,43
JB22-6	14-17	7	3,02
JB22-7	15-18	7,5	3,02
JB22-8	17-20	7,5	3,02
JB22-9	18-21	8	3,46
JB22-10	20-23	8	3,80
JB22-11	22-25	8,5	4,38
JB22-12	23-27	8,5	4,77
JB22-13	25-28	9	4,77
JB22-14	28-31	9	5,60
JB22-15	31-34	9,5	6,05
JB22-16	34-37	9,5	7,40
JB22-17	37-40	10	8,10
JB22-18	40-43	10	10,20
JB22-19	43-46	10,5	10,75

2-øre spændering

AISI 304



2-øre spænderinge er en økonomisk løsning for mange simple slangeforbindelser til luft eller væsker. To ører giver ekstra greb, sikrer et konstant tryk om slangen og letter montering. Kanterne er afrundede for at beskytte slangen. Denne model, af AISI 304 stål, er korrosionsbestandig og anbefales især til udendørs applikationer.

Lavtryk			
Varenr.	Ø	-	DKK
JB22R-0	5-7	6	3,57
JB22R-1	7-9	6	3,92
JB22R-2	9-11	6,5	4,38
JB22R-3	11-13	6,5	4,77
JB22R-4	13-15	7	5,75
JB22R-5	14-17	7	6,15
JB22R-6	15-18	7,5	6,40
JB22R-7	17-20	7,5	6,95
JB22R-8	18-21	8	7,40
JB22R-9	20-23	8	7,60
JB22R-10	22-25	8,5	9,35

Fjeder spændering

STÅL



Fjeder spænderinge fordeler trykket jævnt omkring slangen og anbefales ved forekomst af hurtige temperaturændringer, som forårsager udvidelse og sammentrækning af slangen. Fjeder spænderingen fastholder konstant pres, hvilket forhindrer lækager.

Lavtryk			
Varenr.	Ø	-	DKK
JB26-1	6	7	1,37
JB26-2	7	7	1,37
JB26-3	8	8	1,37
JB26-4	9	8	1,37
JB26-5	10	8	1,37
JB26-6	11	8	1,71
JB26-7	12	8	1,71
JB26-8	14	8	1,94
JB26-9	15	8	2,04
JB26-10	17	8	2,21
JB26-11	20	8	2,55

Spændering

STÅL



Spændering til konkurrencedygtige priser til specielle applikationer. De anvendes i lavtryks-applikationer og især til spiralslanger med lille diameter.

Lavtryk			
Varenr.	Ø	-	DKK
JB25-1	7,3-7,8	1	,79
JB25-2	7,8-8,3	1	,79
JB25-3	8,3-8,8	1	,79
JB25-4	8,8-9,3	1	,97
JB25-5	9,3-9,9	1	,97
JB25-6	9,8-10,4	1,2	1,08
JB25-7	10,4-11,0	1,2	1,08
JB25-8	11,0-11,6	1,2	1,08
JB25-9	11,6-12,3	1,5	1,13
JB25-10	12,1-13,1	1,5	1,13
JB25-11	12,9-13,6	1,5	1,13
JB25-12	13,6-14,4	1,5	1,19
JB25-13	14,4-15,1	1,8	1,47
JB25-14	14,8-15,9	1,8	1,47
JB25-15	15,9-16,8	1,8	1,47
JB25-16	16,8-17,7	1,8	1,47
JB25-17	17,7-18,7	1,9	1,82
JB25-18	18,7-19,6	2	1,82
JB25-19	19,6-20,6	2	1,94
JB25-20	20,6-21,6	2	2,43
JB25-21	23,5-24,7	2,2	2,51
JB25-22	25,1-26,4	2,5	2,59
JB25-23	27,9-29,4	2,5	2,59
JB25-24	29,3-30,9	2,8	2,66
JB25-25	34,6-36,4	3	2,66
JB25-26	37,7-39,7	3,2	2,72

Spændering m. skrue

STÅL



Brugen af blødt jern i denne mini spændering betyder, at den tilpasser sig perfekt til slangen og strammer med et fast, men blidt tryk. Denne spændering anbefales til brug ved gasformige væsker med lavt tryk og har også mange applikationer i bilindustrien.

Lavtryk				
Varenr.	Ø	-	NV	DKK
JB37-1	6	8,4	5	2,72
JB37-2	8	9	5	2,85
JB37-3	9	10	6	3,30
JB37-4	9,5-10	10	6	3,30
JB37-5	10-11	10	6	3,30
JB37-6	12-13	10	6	3,30
JB37-7	13-14	10	6	3,51
JB37-8	14-15	10	6	3,57
JB37-9	15-17	10	6	3,64
JB37-10	16-18	10	6	3,64
JB37-11	18-20	10	6	3,69
JB37-12	19-21	10	6	3,75
JB37-13	20-22	10	6	3,80
JB37-14	22-25	10	6	3,80
JB37-15	23-26	10	6	3,86
JB37-16	25-28	10	6	3,92
JB37-17	26-29	10	6	3,99
JB37-18	29-32	10	6	4,10

NV = nøglevidde



SPÆNDEBÅND



Bredt program af spændebånd, både almindelige og rustfri. Der er flere serier, delt op i tryktrin: lavtryk, mellemtryk og højtryk.

Overholder RoHS-direktivet.



Spændebånd AISI 430 (W2) / SKRUE = STÅL



Husets eksklusive design giver dette koldformede spændebånd fremragende præstationer og samtidig er det meget kompakt. Glattet inderside og afrundede kanter beskytter slangen mod skader. Overholder DIN 3017.

Dette spændebånd er velegnet til bilindustrien.

Mellemtryk

Varenr.	Ø	-	NV	BAR	DKK
JB21-1	8-12	9	7	40	3,92
JB21-2	8-16	9	7	45	3,92
JB21-3	12-22	9	7	45	3,92
JB21-4	16-27	9	7	42	4,88
JB21-5	20-32	9	7	36	4,88
JB21-6	25-40	9	7	32	4,88
JB21-6-1	30-45	9	7	28	6,40
JB21-7	32-50	9	7	24	6,40
JB21-8	40-60	9	7	19	6,40
JB21-9	50-70	9	7	17	7,40
JB21-10	60-80	9	7	15	7,40
JB21-11	70-90	9	7	13	7,40
JB21-12	80-100	9	7	11	9,80
JB21-13	90-110	9	7	10	11,15
JB21-14	110-130	9	7	8	12,65
JB21-15	120-140	9	7	7	16,95
JB21-16	130-150	9	7	6	18,25
JB21-17	140-160	9	7	5	20,00

NV = nøglevidde

Spændebånd AISI 316 (W5)



Husets eksklusive design giver dette koldformede spændebånd fremragende præstationer og samtidig er det meget kompakt. Glattet inderside og afrundede kanter beskytter slangen mod skader. Overholder DIN 3017.

Dette spændebånd er velegnet, hvor der er de højeste krav til korrosionsbestandighed.

Mellemtryk

Varenr.	Ø	-	NV	BAR	DKK
JB20-1	8-16	9	7	45	14,90
JB20-3	12-22	9	7	45	14,90
JB20-4	16-27	9	7	42	17,55
JB20-5	20-32	9	7	36	20,00
JB20-6	25-40	9	7	32	20,00
JB20-7	32-50	9	7	24	22,40
JB20-8	40-60	9	7	19	24,65
JB20-9	50-70	9	7	17	26,10
JB20-10	60-80	9	7	15	26,10
JB20-11	70-90	9	7	13	28,35
JB20-12	80-100	9	7	11	32,10
JB20-13	90-110	9	7	10	42,40
JB20-13-1	100-120	9	7	9	46,95
JB20-14	110-130	9	7	8	46,95
JB20-15	120-140	9	7	7	46,95
JB20-16	130-150	9	7	6	51,80
JB20-17	140-160	9	7	5	54,55

NV = nøglevidde

Spændebånd STÅL (W1)



Et innovativt husdesign, der kan tage en masse moment, plus et robust koldformet 12mm bånd, resulterer i et højtydende spændebånd. Glattet inderside og facetslebne kanter beskytter slangen mod skader. Overholder DIN 3017.

Ideelt til brug i industrien, hvor man ønsker et robust bånd til en konkurrencedygtig pris. Anbefales især til brug i landbruget og til slanger med væske.

Mellemptryk					
Varenr.	Ø	-	NV	BAR	DKK
JB45-1	16-27	12	7	45	7,10
JB45-2	20-32	12	7	45	7,10
JB45-3	25-40	12	7	40	7,55
JB45-4	30-45	12	7	35	7,95
JB45-5	32-50	12	7	35	8,05
JB45-6	40-60	12	7	30	8,65
JB45-7	50-70	12	7	25	9,55
JB45-8	60-80	12	7	20	11,80
JB45-9	70-90	12	7	17	12,40
JB45-10	80-100	12	7	14	13,60
JB45-11	90-110	12	7	12	14,10
JB45-12	100-120	12	7	10	15,35
JB45-13	110-130	12	7	8	15,35
JB45-14	120-140	12	7	7	16,65
JB45-15	130-150	12	7	6	17,10
JB45-16	140-160	12	7	5	17,55
JB45-17	150-170	12	7	4	21,70
JB45-18	160-180	12	7	3	21,75
JB45-19	170-190	12	7	2	24,50
JB45-20	180-200	12	7	2	24,90
JB45-21	190-210	12	7	1,8	26,15
JB45-22	200-220	12	7	1,8	26,60
JB45-23	210-230	12	7	1,6	27,45
JB45-24	220-240	12	7	1,6	27,90

NV = nøglevidde

Spændebånd GALVANISERET (W1)



Dette koldformede spændebånd kombinerer et innovativt hus med et robust 12mm bånd. Glattet inderside og facetslebne kanter beskytter slangen mod skader. Overholder DIN 3017.

Mellemptryk					
Varenr.	Ø	-	NV	BAR	DKK
JB28-1	16-27	12	7	45	8,85
JB28-2	20-32	12	7	45	8,85
JB28-3	25-40	12	7	40	8,95
JB28-4	30-45	12	7	35	9,25
JB28-5	32-50	12	7	35	9,35
JB28-6	40-60	12	7	30	10,05
JB28-7	50-70	12	7	25	10,55
JB28-8	60-80	12	7	20	12,75
JB28-9	70-90	12	7	17	13,30
JB28-10	80-100	12	7	14	14,60
JB28-11	90-110	12	7	12	14,90
JB28-12	100-120	12	7	10	15,60
JB28-13	110-130	12	7	8	15,95
JB28-14	120-140	12	7	7	16,50
JB28-15	130-150	12	7	6	17,30
JB28-16	140-160	12	7	5	18,00
JB28-17	150-170	12	7	4	26,40
JB28-18	160-180	12	7	3	28,35
JB28-19	170-190	12	7	2	30,70
JB28-20	180-200	12	7	2	34,05
JB28-21	190-210	12	7	1,8	35,80
JB28-22	200-220	12	7	1,8	38,70
JB28-23	210-230	12	7	1,6	42,40
JB28-24	220-240	12	7	1,6	44,90

NV = nøglevidde

Spændebånd AISI 316 (W5)



Et innovativt hus kombineret med et robust koldformet 12mm bånd, alt i AISI 316 syrefast rustfrit stål. Glattet inderside og facetslebne kanter beskytter slangen mod skader. Overholder DIN 3017. Dette spændebånd er ideelt til maritim, petrokemisk og levnedsmiddel brug, hvor de ekstreme betingelser nødvendiggør den højeste kvalitet rustfrit stål.

Mellemptryk					
Varenr.	Ø	-	NV	BAR	DKK
JB27-1	16-27	12	7	45	25,65
JB27-2	20-32	12	7	45	26,70
JB27-3	25-40	12	7	40	28,10
JB27-4	30-45	12	7	35	28,70
JB27-5	32-50	12	7	35	29,90
JB27-6	40-60	12	7	30	35,80
JB27-7	50-70	12	7	25	37,50
JB27-8	60-80	12	7	20	40,65
JB27-9	70-90	12	7	17	42,65
JB27-10	80-100	12	7	14	44,90
JB27-11	90-110	12	7	12	46,95
JB27-12	100-120	12	7	10	49,15
JB27-13	110-130	12	7	8	55,20
JB27-14	120-140	12	7	7	57,90
JB27-15	130-150	12	7	6	60,35
JB27-16	140-160	12	7	5	62,55
JB27-17	150-170	12	7	4	69,90
JB27-18	160-180	12	7	3	72,65
JB27-19	170-190	12	7	2	75,10
JB27-20	180-200	12	7	2	78,10
JB27-21	190-210	12	7	1,8	86,80
JB27-22	200-220	12	7	1,8	88,45
JB27-23	210-230	12	7	1,6	92,00
JB27-24	220-240	12	7	1,6	94,20

NV = nøglevidde

Super spændebånd

STÅL (W1)



Første heavy-duty spændebånd på markedet, der har nydt vældig succes. Højstyrke 8.8 stål møtrik og T-bolt betyder, at Super spændebåndet kan spændes super kraftigt, mens ombukkede kanter beskytter slangen mod skader. Super spændebånd er ideelt til landbruget, spildevands udledning, minedrift eller andre sektorer, hvor man ønsker et robust, konkurrencedygtigt heavy-duty spændebånd.

Højtryk

Varenr.	Ø	-	NV	BAR	DKK
JB29-1	17-19	18	8	45	9,95
JB29-2	20-22	18	8	45	10,40
JB29-3	23-25	18	8	45	10,40
JB29-4	26-28	18	8	45	10,85
JB29-5	29-31	20	10	45	13,95
JB29-6	32-35	20	10	45	14,30
JB29-7	36-39	20	10	40	15,10
JB29-8	40-43	20	10	40	15,10
JB29-9	44-47	22	11	40	21,30
JB29-10	48-51	22	11	40	22,40
JB29-11	52-55	22	11	40	22,65
JB29-12	56-59	22	11	40	23,25
JB29-13	60-63	22	11	36	24,40
JB29-14	64-67	22	11	36	25,40
JB29-15	68-73	24	13	36	31,85
JB29-16	74-79	24	13	36	32,10
JB29-17	80-85	24	13	36	32,40
JB29-18	86-91	25	13	28	33,30
JB29-19	92-97	24	13	28	34,95
JB29-20	98-103	24	13	28	35,25
JB29-21	104-112	24	13	20	38,10
JB29-22	113-121	24	13	20	40,65
JB29-23	122-130	24	13	20	43,50
JB29-24	131-139	26	17	12	54,30
JB29-25	140-148	26	17	12	56,00
JB29-26	149-161	26	17	12	59,00
JB29-27	162-174	26	17	9	61,45
JB29-28	175-187	26	17	9	63,05
JB29-29	188-200	26	17	9	63,65
JB29-30	201-213	26	17	6	65,55
JB29-31	214-226	26	17	6	67,20
JB29-32	227-239	26	17	6	72,40
JB29-33	240-252	26	17	3	75,90

NV = nøglevidde

Supra spændebånd

AISI 430 (W2)



Supra spændebåndet, her i AISI 430 rustfri stål, er den naturlige udvikling af Super JB29. Pga. sin drejelige bro kan Supra åbnes og fastgøres, uden at løsne andet, hvilket letter monteringen også svært tilgængelige steder. Ombukkede kanter sikrer slangen mod beskadigelse.

Et spændebånd til den professionelle industri bl.a. automobil og landbrugsmaskiner samt alle industrielle applikationer, hvor et fremragende og pålideligt spændebånd er påkrævet.

Højtryk

Varenr.	Ø	-	NV	BAR	DKK
JB48-1	17-19	18	8	45	15,85
JB48-2	19-21	18	8	45	16,10
JB48-3	21-23	18	8	45	16,20
JB48-4	23-25	18	8	45	16,35
JB48-5	25-27	18	8	45	16,50
JB48-6	27-29	18	8	45	16,75
JB48-7	29-31	20	10	40	20,10
JB48-8	31-34	20	10	40	20,80
JB48-9	34-37	20	10	40	21,75
JB48-10	37-40	20	10	40	21,85
JB48-11	40-43	20	10	40	22,05
JB48-12	43-47	20	10	40	28,20
JB48-13	47-51	20	10	36	29,30
JB48-14	51-55	20	10	36	29,90
JB48-15	55-59	20	10	36	30,70
JB48-16	59-63	20	10	36	29,30
JB48-17	63-68	20	10	36	31,60
JB48-18	68-73	25	13	28	40,05
JB48-19	73-79	25	13	28	43,25
JB48-20	79-85	25	13	28	44,35
JB48-21	85-91	25	13	20	45,45
JB48-22	91-97	25	13	20	46,35
JB48-23	97-104	25	13	20	47,20
JB48-24	104-112	25	13	12	50,60
JB48-25	112-121	25	13	12	51,80
JB48-26	121-130	25	13	12	53,10
JB48-27	130-140	28	15	9	74,55
JB48-28	140-150	28	15	9	76,20
JB48-29	150-162	28	15	9	78,10
JB48-30	162-174	28	15	6	80,00
JB48-31	174-187	28	15	6	81,90
JB48-32	187-200	28	15	6	84,10
JB48-33	200-213	28	15	3	86,05
JB48-34	213-226	28	15	3	87,95
JB48-35	226-239	28	15	3	90,10
JB48-36	239-252	28	15	3	92,25

NV = nøglevidde

Supra spændebånd

AISI 304 (W4)



Supra spændebåndet, her i AISI 304 rustfrit stål, er den naturlige udvikling af Super JB29. Pga. sin drejelige bro kan Supra åbnes og fastgøres, uden at løsne andet, hvilket letter montering også svært tilgængelige steder. Ombukkede kanter sikrer slangen mod beskadigelse.

Lavet til krævende applikationer, f.eks. marine og levnedsmiddelindustrien, samt industrielle anvendelser, hvor AISI 304 rustfrit stål er påkrævet.

Højtryk

Varenr.	Ø	-	NV	BAR	DKK
JB30-1	17-19	18	8	40	30,40
JB30-2	19-21	18	8	40	32,10
JB30-3	21-23	18	8	40	32,70
JB30-4	23-25	18	8	40	33,30
JB30-5	25-27	18	8	40	36,15
JB30-6	27-29	18	8	40	42,90
JB30-7	29-31	20	10	35	48,35
JB30-8	31-34	20	10	35	50,30
JB30-9	34-37	20	10	35	52,05
JB30-10	37-40	20	10	35	53,45
JB30-11	40-43	20	10	35	54,55
JB30-12	43-47	20	10	35	77,55
JB30-13	47-51	20	10	30	81,65
JB30-14	51-55	20	10	30	83,30
JB30-15	55-59	20	10	30	85,20
JB30-16	59-63	20	10	30	88,20
JB30-17	63-68	20	10	30	93,65
JB30-18	68-73	25	13	20	115,50
JB30-19	73-79	25	13	20	121,50
JB30-20	79-85	25	13	20	122,00
JB30-21	85-91	25	13	15	122,25
JB30-22	91-97	25	13	15	129,50
JB30-23	97-104	25	13	15	134,25
JB30-24	104-112	25	13	10	141,00
JB30-25	112-121	25	13	10	150,25
JB30-26	121-130	25	13	10	165,00
JB30-27	130-140	28	15	6	243,50
JB30-28	140-150	28	15	6	246,75
JB30-29	150-162	28	15	6	252,25
JB30-30	162-174	28	15	3	256,50
JB30-31	174-187	28	15	3	262,50
JB30-32	187-200	28	15	3	265,75
JB30-33	200-213	28	15	3	270,00
JB30-34	213-226	28	15	3	271,50
JB30-35	226-239	28	15	3	278,25
JB30-36	239-252	28	15	3	280,00

NV = nøglevidde

Supra spændebånd

AISI 316 (W5)



Supra spændebåndet, her i AISI 316 rustfri syrefast stål, er den naturlige udvikling af Super JB29. Pga. sin drejelige bro kan Supra åbnes og fastgøres, uden at løsne andet, hvilket letter montering også svært tilgængelige steder. Ombukkede kanter beskytter slangen.

Lavet til krævende applikationer, f.eks. marine applikationer, farmaceutiske og petrokemiske industrier og andet, hvor AISI 316 rustfrit stål er påkrævet.

Højtryk

Varenr.	Ø	-	NV	BAR	DKK
JB49-1	17-19	18	8	40	41,80
JB49-2	19-21	18	8	40	42,40
JB49-3	21-23	18	8	40	42,65
JB49-4	23-25	18	8	40	43,50
JB49-5	25-27	18	8	40	46,65
JB49-6	27-29	18	8	40	55,20
JB49-7	29-31	20	10	35	60,65
JB49-8	31-34	20	10	35	65,55
JB49-9	34-37	20	10	35	66,60
JB49-10	37-40	20	10	35	81,65
JB49-11	40-43	20	10	35	94,75
JB49-12	43-47	20	10	35	102,00
JB49-13	47-51	20	10	30	106,75
JB49-14	51-55	20	10	30	109,00
JB49-15	55-59	20	10	30	112,25
JB49-16	59-63	20	10	30	115,00
JB49-17	63-68	20	10	30	122,75
JB49-18	68-73	25	13	20	149,25
JB49-19	73-79	25	13	20	156,25
JB49-20	79-85	25	13	20	157,25
JB49-21	85-91	25	13	15	157,75
JB49-22	91-97	25	13	15	166,50
JB49-23	97-104	25	13	15	172,75
JB49-24	104-112	25	13	10	181,25
JB49-25	112-121	25	13	10	200,50
JB49-26	121-130	25	13	10	213,50
JB49-27	130-140	28	15	6	314,50
JB49-28	140-150	28	15	6	320,00
JB49-29	150-162	28	15	6	330,25
JB49-30	162-174	28	15	3	335,50
JB49-31	174-187	28	15	3	337,50
JB49-32	187-200	28	15	3	343,00
JB49-33	200-213	28	15	3	348,25
JB49-34	213-226	28	15	3	351,50
JB49-35	226-239	28	15	3	360,00
JB49-36	239-252	28	15	3	362,00

NV = nøglevidde

Spændebånd kasse

AISI 430 (W2) / SKRUE = STÅL



Indhold: 60x8-16, 40x12-22, 40x16-27, 20x20-32, 20x25-40, 20x30-45, 10x32-50, 10x40-60, 6x50-70, 1 skruetrækker

Varenr.	Str.	DKK
JB31-1	-	2573,00

Spændebånd kasse

AISI 304



Indhold: 60x8-16, 40x12-22, 40x16-27, 20x20-32, 20x25-40, 20x30-45, 10x32-50, 10x40-60, 6x50-70, 1 skruetrækker

Varenr.	Str.	DKK
JB32-1	-	4138,75

Ultra spændebånd STÅL (W1)



Ultra kraftigt spændebånd til de tungeste tilspændingsopgaver. 20mm bredt bånd og to M6x45 bolte sikrer ensartet og meget kraftigt pres omkring slangen. Afrundede kanter beskytter slangen mod beskadigelse. Dette er standard modellen i almindeligt stål.

Højtryk

Varenr.	Ø	-	DKK
JB62-1	41-51	20	37,50
JB62-2	46-56	20	37,50
JB62-3	51-61	20	37,50
JB62-4	56-66	20	38,10
JB62-5	61-71	20	38,70
JB62-6	66-76	20	39,20
JB62-7	71-81	20	41,20
JB62-8	76-86	20	41,20
JB62-9	81-91	20	42,65
JB62-10	86-96	20	43,25
JB62-11	91-101	20	44,00
JB62-12	96-106	20	45,20
JB62-13	101-111	20	45,70
JB62-14	106-116	20	46,65
JB62-15	111-121	20	47,75
JB62-16	116-126	20	48,60
JB62-17	121-131	20	48,60
JB62-18	126-136	20	48,60
JB62-19	131-141	20	49,15
JB62-20	136-146	20	52,60
JB62-21	141-151	20	52,60
JB62-22	146-156	20	52,60
JB62-23	151-161	20	53,10
JB62-24	156-166	20	53,10
JB62-25	161-171	20	55,70
JB62-26	166-176	20	55,70
JB62-27	171-181	20	56,25

Ultra spændebånd AISI 316 (W5)



Ultra kraftigt spændebånd til de tungeste tilspændingsopgaver. 20mm bredt bånd og to M6x45 bolte sikrer ensartet og meget kraftigt pres omkring slangen. Afrundede kanter beskytter slangen mod beskadigelse. Dette er AISI 316 modellen, beregnet til de højeste krav med hensyn til korrosionsbestandighed.

Højtryk

Varenr.	Ø	-	DKK
JB63-1	41-51	20	168,75
JB63-2	46-56	20	177,00
JB63-3	51-61	20	177,00
JB63-4	56-66	20	180,25
JB63-5	61-71	20	185,00
JB63-6	66-76	20	187,50
JB63-7	71-81	20	198,75
JB63-8	76-86	20	201,75
JB63-9	81-91	20	206,50
JB63-10	86-96	20	211,00
JB63-11	91-101	20	218,25
JB63-12	96-106	20	222,75
JB63-13	101-111	20	226,75
JB63-14	106-116	20	232,50
JB63-15	111-121	20	240,75
JB63-16	116-126	20	243,50
JB63-17	121-131	20	244,50
JB63-18	126-136	20	245,75
JB63-19	131-141	20	247,25
JB63-20	136-146	20	267,50
JB63-21	141-151	20	268,00
JB63-22	146-156	20	269,25
JB63-23	151-161	20	270,75
JB63-24	156-166	20	272,50
JB63-25	161-171	20	287,00
JB63-26	166-176	20	288,00
JB63-27	171-181	20	292,50

Kvik luk POM (ACETAL)



Varenr.	Ø	DKK
A11-1	8-9	6,55
A11-2	10-12	6,55
A11-3	11-13	6,55
A11-4	13-15	6,55
A11-5	14-16	6,55
A11-6	15-17	6,55
A11-7	16-18	8,05
A11-8	17-19	8,05
A11-9	18-20	8,05
A11-10	20-22	8,05
A11-11	21-23	8,05
A11-12	23-25	8,05
A11-13	24-26	9,75
A11-14	26-30	9,75
A11-15	33-35	9,75
A11-16	35-37	9,75
A11-18	40-42	11,20
A11-19	42-44	11,20
A11-20	44-46	11,20
A11-21	47-49	12,20

TILBEHØR TIL SPÆNDEBÅND



Spændebånd skruetrækker



Varenr.	NV	L	DKK
JB33-2	5	205mm	122,00
JB33-4	7	205mm	122,00
JB33-6	9	205mm	122,00
JB33-7	10	205mm	122,00
JB33-8	11	205mm	122,00
JB33-9	12	205mm	122,00

NV = nøglevidde

Klemtang



Varenr.	Str.	DKK
JB34-1	-	257,25

Klemtang m. sidekæbe



Varenr.	Str.	DKK
JB35-1	-	391,50

INTERNETTET

Få login til vores hjemmeside og følg bedre med i nyheder. Vores hjemmeside opdateres løbende med nye produkter og nye tiltag i firmaet.

Produkterne er altid på hjemmesiden, før det nye katalog går i trykken. På den måde får vi afprøvet, om der er interesse for produkterne.

Du kan også læse om nye medarbejdere og om vores forhåbentlig fortsatte vækst, til gavn for dig som kunde. Flere produkter fra samme leverandør betyder besparede administrative omkostninger. Vores forpligtelse som professionel leverandør til vore kunder gør, at vi altid tænker på den bedst mulige service og kundebetjening; Gode priser og produkter til tiden.

The Google logo is displayed in its characteristic multi-colored font (blue, red, yellow, blue, green, red).

WWW.ROYKON.DK

Google-søgning

Jeg prøver lykken

SVEJSEFITTINGS



608 SVEJSEFITTINGS
RUSTFRI AISI316



610 SVEJSEFITTINGS
ISO RUSTFRI



612 SVEJSEFITTINGS
DIN RUSTFRI



614 SVEJSEUNIONER
RUSTFRI TIL MEJERI



618 SVEJSEFITTINGS
RUSTFRI TIL MEJERI



620 SVEJSEFITTINGS ALU
SØVANDSBESTANDIG

SVEJSEFITTINGS RUSTFRI AISI 316



Her gælder AD-Merkblatt W0/TRD 100, samt PED 97/23/CE



Kan leveres med 3.1 certifikat

Rustfri syrefast svejsefittings. DIN normer er PED godkendt.

Arbejdstrykket varierer efter størrelse og godstykkelse. Følgende gælder for vores fittings:

1/4"-13,5mm: 242 bar,
3/8"-17,2mm: 190 bar,
1/2"-21,3mm: 192 bar,

3/4"-26,9mm: 152 bar,
1"-33,7mm: 121 bar,
1 1/4"-42,4mm: 96 bar,
1 1/2"-48,3mm: 84 bar,
2"-60,3mm: 68 bar,
2 1/2"-76,1mm: 54 bar,
3"-88,9mm: 46 bar,
4"-114,3mm: 36 bar,
5"-139,7mm: 29 bar,

6"-168,3mm: 24 bar,
8"-219,1mm: 19 bar,
10"-273,1mm: 15 bar,
12"-323,9mm: 13 bar.

Svejsebøjning 90°

AISI 316



Svejse T-stk

AISI 316



Med chargenr, 3.1 certifikat muligt

Varenr.	Ø	- -	DKK
D1000	15,0	1,5	128,00
D1001	17,2	1,6	57,35
D1001-1	17,2	1,6 R30	130,50
D1049	20,0	2	78,35
D1003	21,3	2	60,35
D1005	26,9	2	62,00
D1047	28,0	2	98,30
D1006	33,7	2	72,65
D1083	38,0	2	121,50
D1008	42,4	2	84,90
D1055	44,0	2	131,50
D1033	44,5	2	138,25
D1010	48,3	2	97,70
D1012	60,3	2	138,25
D1014	76,1	2	209,00
D1034	84,0	2	300,00

D1018	88,9	2	244,75
D1052-1	101,6	2	492,00
D1035	104,0	2	425,25
D1090	106,0	3	1011,00
D1022	114,3	2	474,00
D1071	129,0	2	675,25
D1025	139,7	2	876,50
D1048	154,0	2	721,50
D1091	156,0	3	1569,75
D1027	168,3	2	994,25
D1046	204,0	2	2005,50
D1092	206,0	3	1643,00
D1030	219,1	2	2050,75
D1031	254,0	2	2614,25
D1093	256,0	3	3874,00
D1088	273,0	2	4711,00
D1094	306,0	3	5624,00
D1095	406,4	3	8909,50

Med chargenr, 3.1 certifikat muligt

Varenr.	Ø	- -	DKK
D2000-1	17,2	1,6	113,25
D2001	21,3	2	127,75
D2003	26,9	2	138,25
D2005	33,7	2	145,50
D2031	38,0	2	273,00
D2007	42,4	2	174,00
D2009	48,3	2	194,25
D2011	60,3	2	269,50
D2013	76,1	2	321,75
D2015	88,9	2	377,50
D2022	104,0	2	703,00
D2090	106,0	3	990,25
D2017	114,3	2	581,00
D2019	139,7	2	2277,50
D2030	154,0	2	1884,00
D2091	156,0	3	1223,00
D2021	168,3	2	1163,00
D2092	206,0	3	1875,75
D2093	256,0	3	3246,00
D2094	306,0	3	7585,00
D2095	406,0	3	10060,00

Svejsse slutmuffe

AISI 316



Med chargenr, 3.1 certifikat muligt			
Varenr.	Ø	- -	DKK
D4000	17,2	2	59,25
D4001	21,3	2	57,10
D4002	26,9	2	91,50
D4003	33,7	2	95,30
D4005	42,4	2	84,90
D4007	48,3	2	64,95
D4010-1	54,0	2	183,50
D4010	60,3	2	160,75
D4013	76,1	2	114,75
D4038	84,0	2	176,25
D4016	88,9	2	148,25
D4019-2	104,0	2	347,00
D4019	114,3	2	168,25
D4021	139,7	2	351,25
D4033	154,0	2	270,50
D4023	168,3	2	423,00
D4032-1	206,0	3	703,00
D4025	219,1	3	672,75

Svejsereduktion

AISI 316



Med chargenr, 3.1 certifikat muligt				
Varenr.	Ø	- -	L	DKK
D3001	26,9 × 21,3	2	38	59,00
D3002	26,9 × 17,2	2	38	99,35
D3003	33,7 × 26,9	2	51	53,30
D3004	33,7 × 21,3	2	51	99,35
D3005	42,4 × 33,7	2	51	65,55
D3006	42,4 × 26,9	2	51	102,00
D3007	42,4 × 21,3	2	51	139,50
D3008	48,3 × 42,4	2	64	93,40
D3009	48,3 × 33,7	2	64	107,75
D3010	48,3 × 26,9	2	64	118,75
D3011	48,3 × 21,3	2	64	273,00
D3012	60,3 × 48,3	2	76	93,40
D3013	60,3 × 42,4	2	76	126,75
D3014	60,3 × 33,7	2	76	163,00
D3015	60,3 × 26,9	2	76	215,75
D3016	60,3 × 21,3	2	76	312,25
D3017	76,1 × 60,3	2	89	102,25
D3018	76,1 × 48,3	2	89	170,75
D3019	76,1 × 42,4	2	89	211,75
D3020	76,1 × 33,7	2	89	432,50
D3056	84,0 × 54,0	2	-	218,00
D3021	88,9 × 76,1	2	89	118,50
D3022	88,9 × 60,3	2	89	194,25
D3023	88,9 × 48,3	2	89	259,50
D3024	88,9 × 42,4	2	89	351,25
D3025	88,9 × 33,7	2	89	406,50
D3073	104,0 × 54,0	2	-	330,25
D3026	114,3 × 88,9	2	102	193,00
D3027	114,3 × 76,1	2	102	336,00
D3028	114,3 × 60,3	2	102	339,25
D3043	129,0 × 104,0	2	-	383,75
D3029	139,7 × 114,3	2	127	430,50
D3030	139,7 × 88,9	2	127	525,00
D3031	139,7 × 76,1	2	127	936,00
D3031-1	139,7 × 60,3	2	127	1171,25
D3061	154,0 × 104,0	2	-	1113,50
D3032	168,3 × 139,7	2	140	525,00
D3033	168,3 × 114,3	2	140	637,00
D3034	168,3 × 88,9	2	140	638,00
D3045	204,0 × 154,0	2	-	686,00
D3062	204,0 × 104,0	2	-	1529,75
D3035	219,1 × 168,3	2	152	1345,25
D3036	219,1 × 139,7	2	152	1374,25
D3037	219,1 × 114,3	2	152	1186,75

Svejskrave

AISI 316



Med chargenr, 3.1 certifikat muligt				
Varenr.	Ø	- -	dia	DKK
D6002	17,2	2	42	28,15
D6006	21,3	2	45	33,10
D6007	25,0	2	58	29,25
D6009	26,9	2	58	44,95
D6014	33,7	2	68	22,95
D6015	38,0	2	78	80,35
D6018	42,4	2	78	47,40
D6019	44,5	2	88	51,00
D6021	48,3	2	88	57,70
D6025	60,3	2	102	74,20
D6026	76,1	2	122	67,75
D6028	88,9	2	138	62,00
D6046	104,0	2	158	178,75
D6032	114,3	2	158	140,25
D6054	106,0	3	158	247,25
D6059	131,0	3	188	152,50
D6035	139,7	2	188	193,75
D6043	154,0	2	212	163,00
D6036	156,0	3	212	432,75
D6037	168,3	2,6	212	214,50
D6048	204,0	2	268	306,50
D6055	206,0	3	268	556,25
D6040	219,1	2,6	268	252,75
D6056	256,0	3	320	331,00
D6058	306,0	3	370	379,50
D6053	323,9	2	370	1008,75
D6057	406,4	3	482	604,00

SVEJSEFITTINGS ISO RUSTFRI



Kan leveres med
3.1 certifikat

ISO rustfri AISI 316 bøjninger, reduktioner
og T-stykker.

Fødevaregodkendt.



Vores fødevareprodukter
opfylder kravene til direkte
kontakt med fødevarer.

Fittings der hører til eliten!

ISO svejsebøjning 90° 1D AISI 316

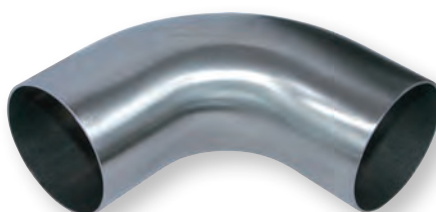

Varenr.	dim	- -	DKK
BP3-6	25	1,2	144,50
BP3-8	38	1,2	174,00
BP3-9	51	1,2	214,00
BP3-10	63,5	1,6	279,50
BP3-11	76,1	2	488,25

ISO svejsebøjning 90° 1,5D AISI 316



Varenr.	dim	- -	DKK
BP5-6	25	1,2	149,75
BP5-8	38	1,2	184,75
BP5-9	51	1,2	215,75
BP5-10	63,5	1,6	289,75
BP5-11	76,1	1,6	517,75
BP5-12	101,6	2	926,00

ISO svejsebøjning 45° 1D AISI 316

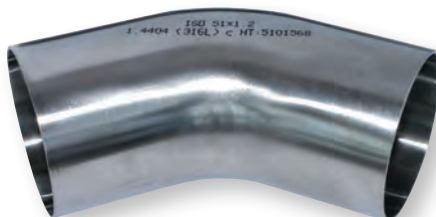

Varenr.	dim	- -	DKK
BP4-6	25	1,2	172,75
BP4-8	38	1,2	233,75
BP4-9	51	1,2	238,25
BP4-10	63,5	1,6	322,00
BP4-11	76,1	2	425,25
BP4-12	101,6	2	790,75

ISO svejsereduktion AISI 316

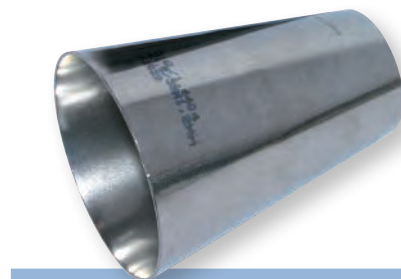

Varenr.	dim	- -	DKK
BP8-1	38 × 25	1,2	196,75
BP8-2	51 × 25	1,2	329,50
BP8-3	51 × 38	1,2	209,00
BP8-4	63 × 25	1,6 × 1,2	741,25
BP8-5	63 × 38	1,6 × 1,2	275,00
BP8-6	63 × 51	1,6 × 1,2	209,00
BP8-7	76 × 25	1,6 × 1,2	1149,50
BP8-8	76 × 38	1,6 × 1,2	350,25
BP8-9	76 × 51	1,6 × 1,2	311,50
BP8-10	76 × 63	1,6 × 1,6	247,50
BP8-11	102 × 38	2 × 1,2	1062,00
BP8-12	102 × 51	2 × 1,2	437,50
BP8-13	102 × 63	2 × 1,6	365,00
BP8-14	102 × 76	2 × 1,6	341,25

ISO svejse T-stk

AISI 316



Varenr.	Ø	- -	DKK
BP9-6	25	1,2	233,75
BP9-8	38	1,2	262,75
BP9-9	51	1,2	299,00
BP9-10	63,5	1,6	376,00
BP9-11	76,1	2	447,75
BP9-12	101,6	2	838,25

ISO svejse T-stk red.

AISI 316



Varenr.	Ø	- -	DKK
BP9-20	38 × 25 × 38	1,2	228,75
BP9-21	51 × 25 × 38	1,2	265,75
BP9-22	51 × 38 × 51	1,2	271,75
BP9-23	63,5 × 25 × 63,5	1,6	339,25
BP9-24	63,5 × 38 × 63,5	1,6	339,25
BP9-25	63,5 × 51 × 63,5	1,6	412,50
BP9-26	76,1 × 25 × 76,1	2	611,50
BP9-27	76,1 × 38 × 76,1	2	418,50
BP9-28	76,1 × 51 × 76,1	2	511,25
BP9-29	76,1 × 63,5 × 76,1	2	418,50
BP9-30	101,6 × 25 × 101,6	2	969,50
BP9-31	101,6 × 38 × 101,6	2	768,75
BP9-32	101,6 × 51 × 101,6	2	843,25
BP9-33	101,6 × 63,5 × 101,6	2	758,00
BP9-34	101,6 × 76,1 × 101,6	2	1115,50
BP9-35	104 × 25 × 104	2	518,25
BP9-36	104 × 38 × 104	2	518,25
BP9-37	104 × 51 × 104	2	518,25
BP9-38	104 × 63,5 × 104	2	518,25
BP9-39	104 × 76,1 × 104	2	518,25

Rørholder, stram

AISI 304



Til påsvejsning

Varenr.	Ø	Skaft Ø	DKK
BP12-4	13,5	8	128,00
BP12-6	25,4	21,3	109,25
BP12-8	38,1	21,3	112,00
BP12-9	51,0	21,3	119,75
BP12-10	63,5	21,3	133,50
BP12-11	76,2	21,3	139,25
BP12-12	101,6	21,3	152,00

Rørholder, løs

AISI 304



Til påsvejsning

Varenr.	Ø	Skaft Ø	DKK
BP12-6L	27,0	21,3	109,25
BP12-8L	40,0	21,3	112,00
BP12-9L	53,0	21,3	119,75
BP12-10L	65,5	21,3	133,50
BP12-11L	78,0	21,3	139,25
BP12-12L	104,0	21,3	152,00



SVEJSEFITTINGS DIN RUSTFRI



Kan leveres med
3.1 certifikat

DIN rustfri AISI 316 bøjninger, reduktioner
og T-stykker.

Fødevaregodkendt.



Vores fødevareprodukter
opfylder kravene til direkte
kontakt med fødevarer.

Fittings der hører til eliten!

DIN svejsebøjning 90° 1D AISI 316



Varenr.	DN	- -	DKK
BP61-3	10	1,5	214,25
BP61-4	15	1,5	214,25
BP61-5	20	1,5	214,25
BP61-6	25	1,5	201,50
BP61-7	32	1,5	227,00
BP61-8	40	1,5	228,00
BP61-9	50	1,5	301,75
BP61-10	65	2	433,75
BP61-11	80	2	751,50
BP61-12	100	2	982,00
BP61-13	125	2	2367,00
BP61-14	150	2	2988,25

DIN svejsebøjning 45° 1D AISI 316

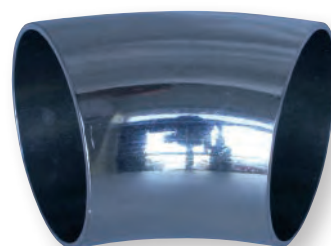

Varenr.	DN	- -	DKK
BP62-6	25	1,5	352,25
BP62-7	32	1,5	387,00
BP62-8	40	1,5	444,00
BP62-9	50	1,5	533,50
BP62-10	65	2	655,00
BP62-11	80	2	1115,50
BP62-12	100	2	1624,50
BP62-13	125	2	3059,25
BP62-14	150	2	4496,00

DIN svejsereduktion

AISI 316

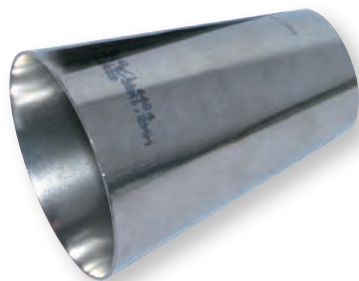

Varenr.	DN	L	DKK
BP63-1	15 × 10	16	77,85
BP63-2	20 × 10	25	114,00
BP63-3	20 × 15	17	71,00
BP63-4	25 × 10	29,5	283,00
BP63-5	25 × 15	17	104,25
BP63-6	25 × 20	19,5	98,85
BP63-7	32 × 15	22	109,50
BP63-8	32 × 20	22	95,80
BP63-9	32 × 25	20	107,25
BP63-10	40 × 15	45	351,25
BP63-11	40 × 20	33,5	112,25
BP63-12	40 × 25	28	89,25
BP63-13	40 × 32	28	84,10
BP63-14	50 × 25	44	124,25
BP63-15	50 × 32	32	124,75
BP63-16	50 × 40	37	96,95
BP63-17	65 × 25	58,5	449,00
BP63-18	65 × 32	52	378,25
BP63-19	65 × 40	38	159,75
BP63-20	65 × 50	31	130,75
BP63-21	80 × 25	89,5	517,75
BP63-22	80 × 32	83	570,25
BP63-23	80 × 40	61	483,75
BP63-24	80 × 50	31,5	202,25
BP63-25	80 × 65	31,5	167,75
BP63-26	100 × 25	112	802,00
BP63-27	100 × 32	105,5	749,25
BP63-28	100 × 40	91,5	713,75
BP63-29	100 × 50	87	583,25
BP63-30	100 × 65	54	281,00
BP63-31	100 × 80	38	221,00
BP63-32	125 × 25	147,5	1367,00
BP63-33	125 × 32	141	1378,25
BP63-34	125 × 40	127	1339,00
BP63-35	125 × 50	122,5	1007,75
BP63-36	125 × 65	89,5	928,25
BP63-37	125 × 80	61	523,50
BP63-38	125 × 100	36	392,00
BP63-39	150 × 65	129	1213,50
BP63-40	150 × 80	93	1074,50
BP63-41	150 × 100	66,5	669,25
BP63-42	150 × 125	40	417,75

DIN svejse T-stk

AISI 316

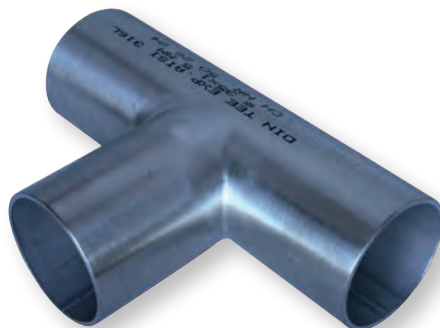

Varenr.	DN	- -	DKK
BP64-3	10	1,5	449,50
BP64-4	15	1,5	449,50
BP64-5	20	1,5	449,50
BP64-6	25	1,5	374,50
BP64-7	32	1,5	469,75
BP64-8	40	1,5	476,50
BP64-9	50	1,5	623,50
BP64-10	65	2	866,25
BP64-11	80	2	1049,75
BP64-12	100	2	1483,25
BP64-13	125	2	4804,00
BP64-14	150	2	8074,25

SVEJSEUNIONER RUSTFRI TIL MEJERI



Kan leveres med
3.1 certifikat

DS, SMS og DIN unioner samt ISO clamps.

Ved denne form for fittings, er dele, der kommer i forbindelse med mediet, lavet af AISI 316. Dele, der ikke "rører" mediet, er lavet af AISI 304.

Fødevaregodkendt.

DS svejseunion

AISI 316



Omløber = AISI 304

Varenr.	dim	DKK
BP1-6	25	250,50
BP1-8	38	307,25
BP1-9	51	378,75
BP1-10	63,5	499,00
BP1-11	76,1	601,50
BP1-12	101,6	1397,75

DS omløber

AISI 304



Varenr.	dim	ØD	DKK
BP1-6B	25	57	74,30
BP1-8B	38	71	78,65
BP1-9B	51	86	101,75
BP1-10B	63,5	103	130,00
BP1-11B	76,1	115	151,75
BP1-12B	101,6	150	529,25

DS svejsekrave

AISI 316



Varenr.	dim	DKK
BP1-6D	25	74,30
BP1-8D	38	104,00
BP1-9D	51	123,00
BP1-10D	63,5	141,50
BP1-11D	76,1	185,25
BP1-12D	101,6	298,50

DS svejsenippel

AISI 316



Varenr.	dim	DKK
BP1-6A	25	102,75
BP1-8A	38	123,00
BP1-9A	51	147,50
BP1-10A	63,5	220,75
BP1-11A	76,1	258,25
BP1-12A	101,6	544,00

DS pakning

NBR



Varenr.	dim	DKK
BP1-6C	25	7,25
BP1-8C	38	8,05
BP1-9C	51	8,05
BP1-10C	63,5	8,05
BP1-11C	76,1	8,05
BP1-12C	101,6	21,45

DS blændskive

AISI 316



Varenr.	dim	ØD	DKK
BP1-6E	25	40	68,50
BP1-8E	38	54	74,30
BP1-9E	51	68	93,40
BP1-10E	63,5	84	117,50
BP1-11E	76,1	96	128,25
BP1-12E	101,6	124	192,50



Vores fødevareprodukter opfylder kravene til direkte kontakt med fødevarer.

Fittings der hører til eliten!

SMS svejseunion AISI 316



Omløber = AISI 304

Varenr.	dim	DKK
BP30-6	25	372,50
BP30-7	32	417,50
BP30-8	38	454,00
BP30-9	51	513,25
BP30-10	63,5	725,00
BP30-11	76,1	890,25
BP30-12	101,6	1968,50

SMS pakning NBR



Varenr.	dim	DKK
BP30-6C	25	4,78
BP30-7C	32	7,70
BP30-8C	38	6,80
BP30-9C	51	7,65
BP30-10C	63,5	6,15
BP30-11C	76,1	7,70
BP30-12C	101,6	32,70

SMS svejsenippel AISI 316



Varenr.	dim	DKK
BP30-6A	25	149,25
BP30-7A	32	167,50
BP30-8A	38	182,50
BP30-9A	51	201,50
BP30-10A	63,5	281,75
BP30-11A	76,1	332,50
BP30-12A	101,6	576,75

SMS svejsekrave AISI 316



Varenr.	dim	DKK
BP30-6D	25	96,40
BP30-7D	32	111,00
BP30-8D	38	122,00
BP30-9D	51	140,25
BP30-10D	63,5	191,00
BP30-11D	76,1	242,00
BP30-12D	101,6	336,50

SMS omløber AISI 304



Varenr.	dim	ØD	DKK
BP30-6B	25	51	124,00
BP30-7B	32	60	131,75
BP30-8B	38	74	152,50
BP30-9B	51	84	176,50
BP30-10B	63,5	100	240,00
BP30-11B	76,1	114	310,50
BP30-12B	101,6	154	807,75

SMS blændskive AISI 316



Varenr.	dim	ØD	DKK
BP30-6E	25	39,5	93,10
BP30-7E	32		110,25
BP30-8E	38	55	124,00
BP30-9E	51	65	141,50
BP30-10E	63,5	80	183,50
BP30-11E	76,1	93	246,50
BP30-12E	101,6	127	368,75

DIN svejseunion

AISI 316



Omløber = AISI 304

Varenr.	DN	L	DKK
BP32-3	10	25mm	378,50
BP32-4	15	25mm	408,75
BP32-5	20	25mm	545,25
BP32-6	25	31mm	467,50
BP32-7	32	31mm	475,75
BP32-8	40	31mm	492,25
BP32-9	50	33mm	572,75
BP32-10	65	35mm	815,00
BP32-11	80	35mm	1592,50
BP32-12	100	41mm	2027,25

DIN omløber

AISI 304



Varenr.	DN	ØD	DKK
BP32-3B	10	38	89,85
BP32-4B	15	44	155,75
BP32-5B	20	54	155,75
BP32-6B	25	63	155,75
BP32-7B	32	70	155,75
BP32-8B	40	78	159,75
BP32-9B	50	92	186,25
BP32-10B	65	112	292,25
BP32-11B	80	127	457,00
BP32-12B	100	148	630,25

DIN svejsekrave

AISI 316



Varenr.	DN	DKK
BP32-3D	10	83,55
BP32-4D	15	89,85
BP32-5D	20	162,25
BP32-6D	25	162,25
BP32-7D	32	162,25
BP32-8D	40	162,25
BP32-9D	50	160,50
BP32-10D	65	207,50
BP32-11D	80	351,25
BP32-12D	100	618,75

DIN svejsenippel

AISI 316



Varenr.	DN	DKK
BP32-3A	10	193,50
BP32-4A	15	164,25
BP32-5A	20	164,25
BP32-6A	25	164,25
BP32-7A	32	176,50
BP32-8A	40	186,25
BP32-9A	50	218,25
BP32-10A	65	297,25
BP32-11A	80	497,00
BP32-12A	100	756,25

DIN pakning

NBR



Varenr.	DN	DKK
BP32-3C	10	6,80
BP32-4C	15	6,80
BP32-5C	20	6,80
BP32-6C	25	6,80
BP32-7C	32	6,80
BP32-8C	40	8,90
BP32-9C	50	8,90
BP32-10C	65	17,90
BP32-11C	80	17,90
BP32-12C	100	17,90

Hagenøgle

GALVANISERET

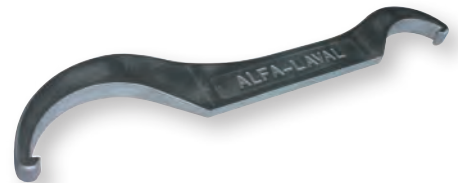

For ISO/DIN unioner

Varenr.	dim	DKK
BP0-2	ISO 25-76 / DIN 20-65	555,25

ISO svejseclamp

AISI 316



Clamp = AISI 304

Varenr.	Ø	DKK
BP2-4	12,7	518,75
BP2-5	19	518,75
BP2-6	25	598,00
BP2-8	38	602,50
BP2-9	51	717,00
BP2-10	63,5	800,50
BP2-11	76,1	969,00
BP2-12	101,6	1443,25

ISO clamp

AISI 304



Varenr.	Ø	ØD	DKK
BP2-4B	12,7		309,50
BP2-5B	19		309,50
BP2-6B	25	63,8	317,50
BP2-9B	51	77,4	387,50
BP2-10B	63,5	90,4	397,25
BP2-11B	76,1	103,6	467,50
BP2-12B	101,6	132,6	520,00

ISO clamp blændskive

AISI 316

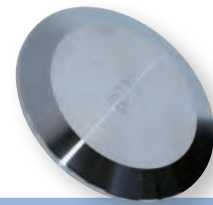

Varenr.	Ø	ØD	DKK
BP2-4E	12,7		118,00
BP2-5E	19		118,00
BP2-6E	25	50,4	124,00
BP2-8E	38	50,4	135,75
BP2-9E	51	63,9	141,50
BP2-10E	63,5	77,4	183,50
BP2-11E	76,1	90,9	294,00
BP2-12E	101,6	118,9	282,75

ISO svejseferrule

AISI 316



Varenr.	Ø	DKK
BP2-4A	12,7	129,50
BP2-5A	19	129,50
BP2-6A	25	133,00
BP2-8A	38	135,25
BP2-9A	51	153,50
BP2-10A	63,5	190,25
BP2-11A	76,1	239,50
BP2-12A	101,6	440,00

ISO clamp pakning

NBR



Varenr.	Ø	ØD	DKK
BP2-4C	12,7		15,60
BP2-5C	19		15,60
BP2-6C	25	52,7	15,60
BP2-8C	38	52,7	15,60
BP2-9C	51	66,2	23,45
BP2-10C	63,5	79,7	23,45
BP2-11C	76,1	93,2	23,45
BP2-12C	101,6	121,2	44,45

SVEJSEFITTINGS RUSTFRI TIL MEJERI



Kan leveres med
3.1 certifikat

DS, SMS og DIN unioner samt ISO clamps.

Ved denne form for fittings, er dele, der kommer i forbindelse med mediet, lavet af AISI 316. Dele, der ikke "rører" mediet, er lavet af AISI 304.

Fødevaregodkendt.



Vores fødevareprodukter opfylder kravene til direkte kontakt med fødevarer.

Fittings der hører til eliten!

Butterflyventil

AISI 316



Uden håndtag

Varenr.	dim	DKK
BP33-6	25	2110,50
BP33-8	38	2136,25
BP33-9	51	2305,25
BP33-10	63,5	2770,75
BP33-11	76,1	3613,25
BP33-12	101,6	4517,75

Håndtag

AISI 316



Varenr.	dim	DKK
BP33-8-H	25-63,5	501,75
BP33-11-H	76,1	832,50
BP33-12-H	101,6	832,50

Pakningsæt

EPDM



Varenr.	dim	DKK
BP33-6A	25	349,75
BP33-8A	38	362,75
BP33-9A	51	392,00
BP33-10A	63,5	374,25
BP33-11A	76,1	574,25
BP33-12A	101,6	1002,00



Aktuator til BP33

AISI 304



Varenr.	dim	DKK
BP33-6B	25	7173,00
BP33-8B	38	7196,75
BP33-9B	51	7367,75
BP33-10B	63,5	7844,50
BP33-11B	76,1	8528,50
BP33-12B	101,6	9424,50

Inkl. bolte

Kontraventil

AISI 316



Varenr.	dim	DKK
BP70-6	25	4663,00
BP70-8	38	5110,00
BP70-9	51	5966,00
BP70-10	63,5	7844,50
BP70-11	76,1	9883,00
BP70-12	101,6	19086,00

Tankrenser roterende

AISI 316 - BSPP



ø3/4" L=102mm

Varenr.	m ³ /h	Output	DKK
BP73-5	5,5	360°	6489,00

Rense- tankdæksel

AISI 316



Dim = LxBxH

Varenr.	dim	DKK
BP41-1	440 x 320 x 60	5046,00

Grov filter

AISI 316



Tankrenser roterende

AISI 316



Clip-on Ø17,4 L=62mm

Varenr.	m ³ /h	Output	DKK
BP74-1	2,9	360°	8538,75
BP74-2	1,8	360° low flow	8538,75
BP74-3	2,8	270°	8538,75
BP74-4	1,8	270° low flow	8538,75

Rense- tankdæksel

AISI 316



Dim = ØxH

Varenr.	dim	DKK
BP42-1	454 x 100	6083,25
BP42-2	520 x 100	7950,75

Inkl. filterindsats m. 2mm huller

Varenr.	dim	- -	H	DKK
BP81-6	25	1,2	419mm	11057,25
BP81-7	38	1,2	375mm	11057,25
BP81-8	51	1,1	333mm	11325,00
BP81-9	63,5	1,6	467mm	16511,00
BP81-10	76,1	2	428mm	23669,50

Grov filter

AISI 316



Rense- tankdæksel

AISI 316



Dim = LxBxH

Varenr.	dim	DKK
BP40-1	234 x 184 x 40	3307,50

Grov filter

AISI 316



Inkl. filterindsats m. 3mm huller

Varenr.	dim	- -	H	DKK
BP82-6	25	1,2	419mm	11057,25
BP82-7	38	1,2	375mm	11057,25
BP82-8	51	1,1	333mm	11325,00
BP82-9	63,5	1,6	467mm	16511,00
BP82-10	76,1	2	428mm	23669,50

Inkl. filterindsats m. 1mm huller

Varenr.	dim	- -	H	DKK
BP80-6	25	1,2	419mm	11057,25
BP80-7	38	1,2	375mm	11057,25
BP80-8	51	1,1	333mm	11325,00
BP80-9	63,5	1,6	467mm	16511,00
BP80-10	76,1	2	428mm	23669,50

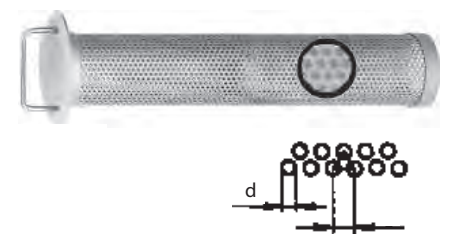

SVEJSEFITTINGS ALU SØVANDSBESTANDIG



EN-AW-6060



Aluminium svejsefittings, inkl. bøjninger, reduktioner, T-stykker, slutmuffer, svejse- nipler samt svejsemuffer.

Svejsebøjning 90° 1D ALUMINIUM



Kort radius

Varenr.	Ø	- -	DKK
DA1-1	60	3	308,00
DA1-2	60	5	362,00
DA1-3	76	3	431,00
DA1-4	89	3	471,25
DA1-5	90	5	492,75
DA1-6	100	3	571,75
DA1-7	108	4	608,50
DA1-8	110	5	760,00
DA1-9	114	4	854,50
DA1-10	160	5	1748,00

Svejsebøjning 90° 1,5D ALUMINIUM



Lang radius

Varenr.	Ø	- -	DKK
DA2-1	25	3	189,75
DA2-2	30	3	204,75
DA2-3	35	2,5	224,25
DA2-4	40	3	218,25
DA2-5	45	3	246,50
DA2-6	48	4	281,75
DA2-7	50	3	295,50
DA2-8	50	5	318,25
DA2-9	56	3	314,50
DA2-10	60	3	285,75
DA2-11	60	5	347,25
DA2-12	71	3	371,50
DA2-13	75	5	574,00
DA2-14	76	3	401,25
DA2-15	80	3	410,25
DA2-16	80	5	600,75
DA2-17	86	3	429,75
DA2-18	89	3	444,25
DA2-19	90	5	502,25
DA2-20	100	3	547,50
DA2-21	108	4	617,00
DA2-22	110	5	684,75
DA2-23	114	3	802,50
DA2-24	133	4	912,50
DA2-25	160	5	1804,75
DA2-26	168	3	1997,25
DA2-27	219	5	2309,50

Svejsebøjning 90° 1,5D ALUMINIUM



Lang radius

Varenr.	Ø	- -	DKK
DA9-1	21,3	2,77	385,00
DA9-2	26,7	2,87	513,25
DA9-3	33,4	3,38	568,50
DA9-4	48,3	3,68	623,25
DA9-5	60,3	3,91	715,25
DA9-6	73,0	5,16	1099,25
DA9-7	88,9	5,49	1649,25
DA9-10	114,3	8,56	3849,25

Svejsebøjning 90° m. nippel ALUMINIUM - BSPP



Varenr.	Ø × BSPP	- -	DKK
DA3-1	60 × 2"	5	684,75
DA3-2	89 × 3"	5	1066,25



580

Svejsereduktion konc. ALUMINIUM



Varenr.	Ø	- -	DKK
DA4-1	89 × 60	3	647,75
DA4-2	89 × 76	3	668,75
DA4-3	90 × 60	5	692,75
DA4-4	108 × 76	3	1167,00
DA4-5	108 × 89	3	720,25
DA4-6	108 × 89	4	736,50
DA4-7	108 × 89	5	760,00
DA4-8	114,3 × 89	3	675,25
DA4-9	133 × 108	4	757,25
DA4-10	159 × 108	4	1286,50

Svejs T-stk ALUMINIUM



Varenr.	Ø	- -	DKK
DA6-1	60	5	1587,25
DA6-2	76	3	1663,50
DA6-3	89	4	1862,25
DA6-4	108	4	2015,75

Nippelrør ALUMINIUM - BSPP

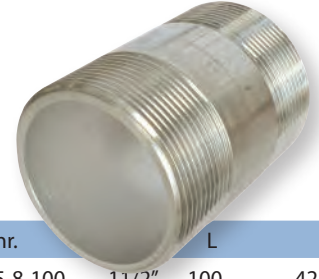

Varenr.	Ø	L	DKK
DA25-8-100	1 1/2"	100	423,75
DA25-9-080	2"	80	473,00
DA25-9-160	2"	160	505,50
DA25-11-080	3"	80	554,75
DA25-12-100	4"	100	701,00
DA25-12-520	4"	520	2354,75

Svejsereduktion konc. ALUMINIUM



Varenr.	Ø	- -	DKK
DA12-3	60,3×33,4	3,38	916,25
DA12-4	60,3×42,2	3,56	1063,00
DA12-5	60,3×48,3	3,68	1174,25
DA12-6	88,9×60,3	3,91	1283,50
DA12-10	114,3×88,9	5,49	1430,75

Svejs T-stk ALUMINIUM



Varenr.	Ø	- -	DKK
DA10-1	33,4	3,38	1228,00
DA10-2	60,3	3,90	1466,75
DA10-3	88,9	5,49	2565,75
DA10-4	114,3	6,02	2931,50

Svejsenippel m. udv. gevind ALUMINIUM - BSPP



Varenr.	dim	L	DKK
DA26-2	1/4"	50mm	96,95
DA26-4	1/2"	50mm	105,25
DA26-5	3/4"	50mm	139,25
DA26-6	1"	60mm	132,00
DA26-7	1 1/4"	65mm	162,00
DA26-8	1 1/2"	45mm	139,25
DA26-9	2"	45mm	146,50
DA26-10	2 1/2"	45mm	186,75
DA26-11	3"	60mm	189,75
DA26-12	4"	60mm	385,25

Svejsereduktion exc. ALUMINIUM



Varenr.	Ø × Ø	- -	DKK
DA5-1	89 × 60	5	738,50
DA5-2	89 × 76	3	687,00
DA5-3	108 × 89	4	808,75
DA5-4	108 × 89	5	819,00
DA5-5	133 × 108	4	1208,25

Bøjning 90° nip/nip ALUMINIUM - BSPP



Varenr.	BSPP	- -	DKK
DA8-6	1"	3	1049,75
DA8-9	2"	5	1411,25
DA8-11	3"	5	1759,25

Svejssemuffe m. indv. gevind

ALUMINIUM - BSPP



Varenr.	dim	L	DKK
DA22-2	1/4"	25mm	119,50
DA22-3	3/8"	30mm	125,75
DA22-4	1/2"	35mm	121,50
DA22-5	3/4"	40mm	170,25
DA22-6	1"	45mm	203,50
DA22-7	1 1/4"	50mm	233,75
DA22-8	1 1/2"	55mm	293,00
DA22-9	2"	60mm	330,00
DA22-10	2 1/2"	70mm	526,25
DA22-11	3"	75mm	671,75
DA22-12	4"	90mm	1185,75

Svejse slutmuffe

ALUMINIUM



Varenr.	Ø	- -	DKK
DA7-1	89	3	287,00
DA7-2	108	4	1004,75
DA7-3	159	3	1748,00

TILBEHØR



625 FITTINGS TILBEHØR



628 STRIPS



631 SIKKERHEDSUDSTYR



635 ARBEJDSHANDSKER



641 SLUSER & MÅTTER

LAD OS HØRE FRA DIG

ROYKON AS har bred erfaring i levering af specialkomponenter i rustfri og messing. Vi kan tilbyde serier fra 100 til mange 100.000 enheder.

De fabrikker, vi får produceret på, besøges i gennemsnit en gang om året. Vi har igennem årene haft et langt udskillelsesløb, hvor de fabrikker, vi bruger i dag, er fabrikker med meget høje standarder og kvalitetskrav.

Vi tilbyder at give en hurtig pris på dine specialkomponenter og på pro-

duktionssiden betyder det, at vi i udviklingsfasen har lynhurtig tilbagemelding og at kvaliteten af produkterne er, som vores kunder har specificeret.

Vores leverandører er miljøbeviste, benytter ikke børnearbejde og har ordnede forhold for alle medarbejdere.

Således føler vi os nu rustet til at levere kvalitetsfittings til virksomheder, for hvem kvalitet er en selvfølge og hvor miljø og social bevidsthed har betydning.

**RING FOR ET
UFORPLIGTENDE
BESØG PÅ TELEFON:**

75 945 955



FITTINGS TILBEHØR



Her findes diverse tætningsmaterialer, trykprøvningspumper og andet, der kan sikre en tæt og sikker samling af fittings eller en nem og hurtig udbedring af utætheder.

Rustløser



Varenr.	Vol.	DKK
s1006-3	300 ml	107,75

Alu/zink spray



Coating til reparation af galvaniserede overflader. Permanent glans.

Varenr.	Vol.	DKK
s1006-6	400 ml	245,75

Lækagesøger til gas og luft



Finder lækager i gas- og luftsystemer. Ryst dåsen og sprøjt i en afstand af 30-50cm mod det mistænkte område. Ved lækage fremkommer små bobler.

Varenr.	Vol.	DKK
s1006-8	400 ml	151,50

Zincspray til galvanisering



Varenr.	Vol.	DKK
s1006-5	400 ml	218,75

Lækagesøger til gas og luft



Finder lækager i gas- og luftsystemer. Ryst dåsen og sprøjt i en afstand af 30-50cm mod det mistænkte område. Ved lækage fremkommer små bobler. Leveres m. tud.

Varenr.	Vol.	DKK
s1004-1	400 ml	100,75

Skærepasta



Varenr.	Str.	DKK
K24-1	100ml	180,75

Smøreolie på spray



Varenr.	Vol.	DKK
s1006-4	300 ml	124,75

GEVINDTÆTNINGSTAPE

UNIPAK gevindtætningstape er 100% Polytetrafluorethylen (PTFE), kendt som Teflon®. Massefylden (g/cm^3) er et mål for tapens kvalitet; jo højere, jo bedre. LD, MD og HD = Low, Medium og High Density.

ANVENDELSE:

Gevindtape kan tætte gevindsamlinger på alle materialer (jern, metal, plastik, fiber osv.) og klarer højeste hygiejnekrav.

TEKNISKE EGENSKABER:

PTFE-tape har fremragende egenskaber: bredt temperaturområde, -200° til $+260^\circ\text{C}$ (brug massefylde $1 \text{ gr}/\text{cm}^3$ over $+90^\circ\text{C}$). Kemikalieresistent, undtagen overfor fluor, fluor-kemikalier og smeltede alkali-metaller. Lav friktion. Ikke brændbar. Ældes ikke. Fugt og UV resistent. Udmærket trækstyrke. Fin elektrisk isolationsevne.

BRUGSANVISNING:

Tapen anvendes uden smøremidler. Rens gevindet. Pålæg tapen stramt i gevindets stigningsretning med et jævnt, fast træk og overlappning på $\frac{1}{2}$ til $\frac{3}{4}$ tapebredde ud fra ønsket lagtykkelse. Skru ikke kontra, når gevindstykkerne er spændt sammen.

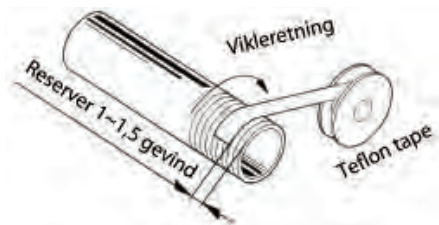

UNITAPE

PTFE (TEFLON) LOW DENSITY



LD teflon, massefylde: $0,35\text{g}/\text{cm}^3$.
Temp: -200° til $+100^\circ\text{C}$, max 20bar.
Velegnet til vand og luft.

Anbefalet max rørdiameter: 3/4"

Varenr.	dim	L	DKK
s1001	12mmx75my	12m	7,00

JUMBOTAPE

PTFE (TEFLON) MEDIUM DENSITY



MD teflon, massefylde: $0,59\text{g}/\text{cm}^3$.
Temp: -200° til $+160^\circ\text{C}$, max 20bar.
Velegnet til vand, luft og damp. Stærk og fleksibel - ideel til store, grove el. skarpe gevind (rustfri). Drøj i brug.

Anbefalet max rørdiameter: 2 1/2"

Varenr.	dim	L	DKK
s1002-1	19mmx200my	15m	93,90

MAXITAPE

PTFE (TEFLON) MEDIUM DENSITY



MD teflon, massefylde: $0,7\text{g}/\text{cm}^3$.
Temp: -200° til $+160^\circ\text{C}$, max 30bar.
Velegnet til vand og luft plus damp og hydraulik, og de fleste kemikalier, syrer, baser, opløsningsmidler mv.

Anbefalet max rørdiameter: 1 1/4"

Varenr.	dim	L	DKK
s1002	12mmx100my	12m	17,05

MULTITAPE

PTFE (TEFLON) HIGH DENSITY



HD teflon, massefylde: $1\text{g}/\text{cm}^3$.
Temp: -200° til $+260^\circ\text{C}$, max 60 bar.
Godkendt til gas og velegnet til hydraulik.

Anbefalet max rørdiameter: 1 1/4"

Varenr.	dim	L	DKK
s1002-6	12mmx100my	12m	80,00

TOPSEAL

PTFE (TEFLON) HIGH DENSITY



HD teflon, massefylde: $1,3\text{g}/\text{cm}^3$.
Temp: -200° til $+260^\circ\text{C}$, max 20bar.
Velegnet til vand og luft. Meget diffusions-tæt og modstandsdygtig overfor syre, tryk og varme. Godkendt til gas.

Anbefalet max rørdiameter: 2"

Varenr.	dim	L	DKK
s1002-4	12mmx100my	12m	102,00

SEALRITE

PTFE (TEFLON) HIGH DENSITY



HD teflon, massefylde: $1,1\text{g}/\text{cm}^3$.
Temp: -200° til $+260^\circ\text{C}$, max 20bar.
Ultimativ gevindtape mht. kvalitet og sikkerhed. Meget stærk og drøj. Mindre velegnet til fine gevind. Godkendt til gas.

Anbefalet max rørdiameter: 2"

Varenr.	dim	L	DKK
s1002-7	12mmx200my	5m	103,50
s1002-8	19mmx200my	5m	132,00

Unipak paksalve



Højviskos paksalve. Indeholder en ugiftig forsæbning med naturlige mineraler, olier og vand, der alle er tilladt som tilsætningsstoffer til fødevarer og lign.

Varenr.	Vol.	DKK
s1005-3	65 gram	53,10
s1005-4	250 gram	80,00
271351036	360 gram	71,25

ANVENDELSE:

Unipak paksalve anvendes sammen med pakgarn til pakning af gevindsamlinger.

TEKNISKE EGENSKABER:

Unipak paksalve plus pakgarn giver helt tætte gevindsamlinger og høj fleksibilitet ved justering af samlinger, da de forbliver tætte ved tilbageskruing.

BRUGSANVISNING:

Pakgarn påføres hele gevindet jævnt og tæt i sammenskruiningsretningen. Unipak paksalve påsmøres i et jævnt lag og emnerne samles og kan straks tages i brug. Evt. overskydende paksalve aftørres med klud eller lign.

FORSØG:

DTI har testet Unipak paksalve sammen med pakgarn. Disse tests viser, at der kan opnåes rørsamlinger, der er tætte op til 140°C og ved 8 bars tryk. Undersøgelser har også vist, at Unipak paksalve ikke influerer på vandkvaliteten.

Multipak paksalve



Ikkehærdende universalpaksalve, velegnet til anlæg med drikkevand, gas, varme (+90°C), lavtryksdamp (+130°C), trykluft (16bar) og køling. Tåler frost.

Varenr.	Vol.	DKK
s1005-1	500 gram	147,25

Unipak pakgarn

HØR



Et rent naturprodukt, som er fremstillet af fint, ensartet og langfibret belgisk heglet hør, der kommer fra hørplantens stængel. Max +120°C, ellers risiko for svidning.

Varenr.	Vol.	Type	DKK
271302008	80 g	A	71,80
271302508	80 g	B	132,50
271301010	100 g	C	16,95
271301050	500 g	C	79,45
271301100	1000 g	C	186,00

☒ = genbrugelig bølge

ANVENDELSE:

Pakgarn påføres gevindet jævnt og tæt i stigningsretningen i dets fulde udstrækning. Dernæst påsmøres hele det pakkede gevind en passende mængde paksalve i et jævnt lag, hvorefter sammenspænding straks kan foretages og anlægget tages i brug.

Uniflon gevindsnor

PTFE (TEFLON)



-200° til +240°C, max 100bar (20°C). 100% teflonsnor til gevind, både metal og plast. Nem at montere. Resistent over for vand, varme og frost.

Varenr.	Vol.	DKK
s1006-7	175 m	463,00



EASYFIT gevindtætning



Gastec og EN-751-1 (H) godkendt.

TØRRETID

Messing/kobber: 3 timer
Galvaniseret stål: 24 timer
Rustfri stål: 72 timer

Må IKKE anvendes til PVC eller anden form for plastik.

Varenr.	Vol.	DKK
s1006-1	50 ml	272,50

STRIPS



-40°C til +85°C



Kabelbindere, strips, bruges overalt i elektriske installationer; både i boligen og industrien.

Vi lagerfører strips i mange forskellige størrelser og farver. Brug de sorte strips udenfor, de er UV bestandige.

Materiale: Polyamid (PA 6)
Temp: -40°C til +85°C

Karakteristika:

- god kombination af styrke, stivhed og hårdhed
- høj slidstyrke
- god kemikalieresistens

Kemikaliebestandig over for:

- olieprodukter, benzin, fedtstoffer, smøre- og opløsningsmidler som alkohol, ketoner, ester og ether

Ikke bestandig over for:

- mange syrer, stærke baser og oxidationsmidler
- klorbaserede produkter

Strips sælges kun i poser à 100 styk, men bemærk at priserne er stykpriser.

Strips, hvid

PA (POLYAMID)

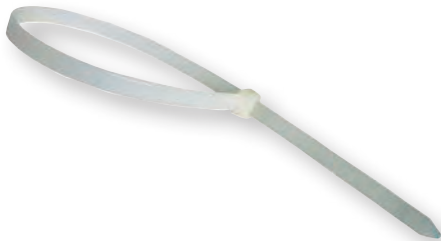

NB! Sælges kun i poser à 100 stk!

Varenr.	L	-	DKK/stk
H1-1	80	2,4	0,16 α
H1-2	100	2,5	0,16
H1-4	120	4,8	0,50
H1-5	140	2,5	0,23
H1-6	140	3,6	0,34 α
H1-7	150	3,6	0,39
H1-8	150	7,6	1,08
H1-9	160	2,5	0,29
H1-10	160	4,8	0,50
H1-11	180	3,6	0,50
H1-12	190	4,8	0,58 α
H1-13	200	2,5	0,34
H1-14	200	3,6	0,50
H1-15	200	4,8	0,58
H1-16	200	7,6	1,37
H1-17	216	4,8	0,79
H1-18	240	12,6	4,10
H1-19	250	2,8	0,58
H1-20	250	3,6	0,69
H1-21	250	4,8	0,79

H1-22	250	7,6	1,82
H1-23	266	4,8	0,85
H1-24	280	4,8	0,85
H1-25	300	2,8	0,74
H1-26	300	3,6	0,69
H1-27	300	4,8	0,97 α
H1-28	300	7,6	1,82
H1-29	300	12,6	6,40
H1-30	370	3,6	1,13
H1-31	370	4,8	1,13 α
H1-32	370	7,6	2,21
H1-33	390	4,8	1,71
H1-34	390	12,6	6,80
H1-35	430	4,8	1,82
H1-36	430	7,6	3,69
H1-37	430	9,0	3,46
H1-38	450	4,8	3,02
H1-39	490	12,6	6,95
H1-40	530	4,8	3,46
H1-41	530	7,6	4,38
H1-42	530	9,0	4,20
H1-43	550	4,8	3,80

H1-44	590	12,6	8,85
H1-45	610	9,0	5,60
H1-46	635	4,8	4,38
H1-47	685	4,8	4,49
H1-48	710	9,0	6,35
H1-49	730	4,8	4,88
H1-50	740	12,6	8,95
H1-51	780	9,0	6,95
H1-52	830	9,0	8,75
H1-53	840	12,6	11,85
H1-54	890	12,6	13,30
H1-55	920	9,0	9,15
H1-56	1020	9,0	11,40
H1-57	1040	12,6	13,40
H1-58	1070	9,0	12,00
H1-59	1220	9,0	13,40
H1-60	1530	9,0	18,55

α = altid på lager i større mængder

Strips sort PA (POLYAMID)



Strips, grøn PA (POLYAMID)

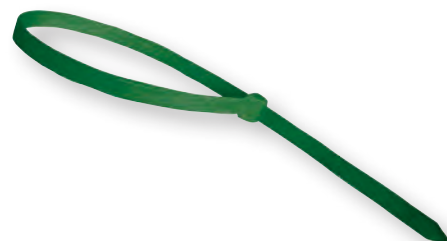

NB! Sælges kun i poser à 100 stk!

Varenr.	L	-	DKK/stk
H2-1	80	2,4	0,16 □
H2-2	100	2,5	0,16
H2-4	120	4,8	0,50
H2-5	140	2,5	0,23
H2-6	140	3,6	0,34 □
H2-7	150	3,6	0,39
H2-8	150	7,6	1,08
H2-9	160	2,5	0,29
H2-10	160	4,8	0,50
H2-12	190	4,8	0,58 □
H2-13	200	2,5	0,34
H2-14	200	3,6	0,50
H2-15	200	4,8	0,58
H2-16	200	7,6	1,37
H2-17	216	4,8	0,79
H2-18	240	12,6	4,10
H2-19	250	2,8	0,53
H2-20	250	3,6	0,69
H2-21	250	4,8	0,79
H2-22	250	7,6	1,82
H2-23	266	4,8	0,85
H2-24	280	4,8	0,85
H2-25	300	2,8	0,74
H2-26	300	3,6	0,69
H2-27	300	4,8	0,97 □
H2-28	300	7,6	1,82
H2-29	300	12,6	6,40
H2-30	370	3,6	1,13

H2-31	370	4,8	1,13 □
H2-32	370	7,6	2,21
H2-33	390	4,8	1,71
H2-34	390	12,6	6,80
H2-35	430	4,8	1,82
H2-36	430	7,6	3,69
H2-37	430	9,0	3,46
H2-38	450	4,8	3,02
H2-39	490	12,6	6,95
H2-40	530	4,8	3,46
H2-41	530	7,6	4,38
H2-42	530	9,0	4,20
H2-43	550	4,8	3,80
H2-44	590	12,6	8,85
H2-46	635	4,8	4,38
H2-47	685	4,8	4,49
H2-48	710	9,0	6,35
H2-49	730	4,8	4,88
H2-50	740	12,6	8,95
H2-51	780	9,0	6,95
H2-52	830	9,0	8,75
H2-53	840	12,6	11,85
H2-54	890	12,6	13,30
H2-55	920	9,0	9,15
H2-56	1020	9,0	11,40
H2-57	1040	12,6	13,40
H2-58	1070	9,0	12,00
H2-59	1220	9,0	13,40
H2-60	1530	9,0	18,55

□ = altid på lager i større mængder

NB! Sælges kun i poser à 100 stk!

Varenr.	L	-	DKK/stk
H3-2	100	2,5	0,16
H3-5	160	2,5	0,22
H3-6	140	3,6	0,33
H3-10	160	4,8	0,49
H3-14	200	3,6	0,49
H3-15	200	4,8	0,55
H3-21	250	4,8	0,76
H3-27	300	4,8	0,93
H3-30	370	3,6	1,09
H3-31	370	4,8	1,09
H3-33	390	4,8	1,64

Strips, gul PA (POLYAMID)

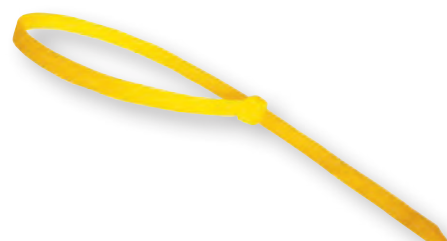

NB! Sælges kun i poser à 100 stk!

Varenr.	L	-	DKK/stk
H4-2	100	2,5	0,16
H4-5	160	2,5	0,22
H4-6	140	3,6	0,33
H4-10	160	4,8	0,49
H4-14	200	3,6	0,49
H4-15	200	4,8	0,55
H4-21	250	4,8	0,76
H4-27	300	4,8	0,93
H4-30	370	3,6	1,09
H4-31	370	4,8	1,09
H4-33	390	4,8	1,64

Strips, blå

PA (POLYAMID)

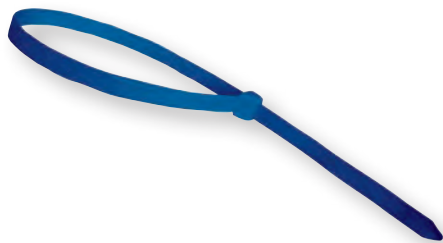

NB! Sælges kun i poser à 100 stk!

Varenr.	L	-	DKK/stk
H5-2	100	2,5	0,16
H5-5	160	2,5	0,22
H5-6	140	3,6	0,33
H5-10	160	4,8	0,49
H5-14	200	3,6	0,49
H5-15	200	4,8	0,55
H5-21	250	4,8	0,76
H5-27	300	4,8	0,93
H5-30	370	3,6	1,09
H5-31	370	4,8	1,09
H5-33	390	4,8	1,64

Strips, rød

PA (POLYAMID)

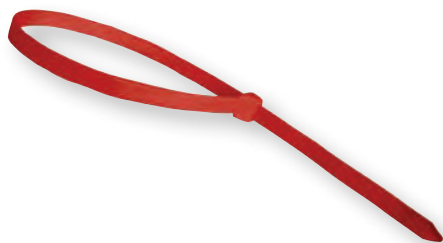

NB! Sælges kun i poser à 100 stk!

Varenr.	L	-	DKK/stk
H6-2	100	2,5	0,16
H6-5	160	2,5	0,22
H6-6	140	3,6	0,33
H6-10	160	4,8	0,49
H6-14	200	3,6	0,49
H6-15	200	4,8	0,55
H6-21	250	4,8	0,76
H6-27	300	4,8	0,93
H6-30	370	3,6	1,09
H6-31	370	4,8	1,09
H6-33	390	4,8	1,64

SIKKERHEDSUDSTYR



CE godkendt

Sikkerhedsudstyr til industrien.

Ørepropper

PVC (POLYVINYLCHLORID)



Varenr.	Reduc.	Standard	DKK
DM1-1	28 dB	EN 352-2	6,40

Bløde, formbare

Ørepropper

SILICONE

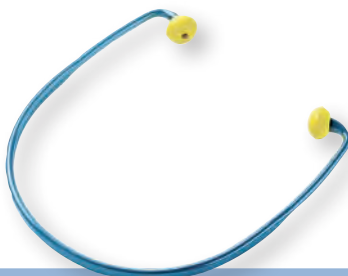

Varenr.	Reduc.	Standard	DKK
DM4-1	20 dB	EN 352-2	112,00

På let plastbøjle

Ørepropper

PU (POLYURETHAN)



Varenr.	Reduc.	Standard	DKK
DM2-1	37 dB	EN 352-2	3,92

Bløde, formbare

Høreværn



Varenr.	Reduc.	Standard	DKK
DM10-1	26 dB	EN 352-1	527,00

Let og komfortabel. Til kraftig støj

Ørepropper

TPE



Varenr.	Reduc.	Standard	DKK
DM3-1	25 dB	EN 352-2	69,65

Ergonomiske ørepropper med snor

Høreværn



Varenr.	Reduc.	Standard	DKK
DM12-1	30 dB	EN 352-1	859,25

Roterbar og justerbar. Til kraftig støj

Beskyttelsesmaske

STOF



Masker kan beskytte alene mod faste partikler eller både mod faste partikler og væskeformige aerosoler. Er masken afprøvet efter EN149:2001, beskytter den både mod faste partikler og væskeformige aerosoler.

De simpleste masker er uklassificerede og yder kun begrænset beskyttelse.

Varenr.	Max.	Standard	Class	DKK
DM20-1	-	-	-	3,24

Beskyttelsesmaske P2

STOF



Masker kan beskytte alene mod faste partikler eller både mod faste partikler og væskeformige aerosoler. Er masken afprøvet efter EN149:2001, beskytter den både mod faste partikler og væskeformige aerosoler.

Klasse P2 har en større udskillelsesgrad op til 12 mg/m³ og beskytter derfor i større omfang. Kan bruges mod sundhedsskadeligt og giftigt støv, men ikke mod radioaktivt støv, bakterier og virus.

Varenr.	Max.	Standard	Class	DKK
DM22-1	12mg/m ³	EN 149:2001	P2	21,30

Beskyttelsesmaske P2

STOF



Masker kan beskytte alene mod faste partikler eller både mod faste partikler og væskeformige aerosoler. Er masken afprøvet efter EN149:2001, beskytter den både mod faste partikler og væskeformige aerosoler.

Klasse P2 har en større udskillelsesgrad op til 12 mg/m³ og beskytter derfor i større omfang. Kan bruges mod sundhedsskadeligt og giftigt støv, men ikke mod radioaktivt støv, bakterier og virus.

Varenr.	Max.	Standard	Class	DKK
DM24-1	12mg/m ³	EN 149:2001	P2	34,95

Med ventil

Beskyttelsesmaske P1

STOF



Masker kan beskytte alene mod faste partikler eller både mod faste partikler og væskeformige aerosoler. Er masken afprøvet efter EN149:2001, beskytter den både mod faste partikler og væskeformige aerosoler.

Klasse P1 har den laveste udskillelsesgrad af de klassificerede masker. En P1 maske må ikke bruges, hvis værdien for det forurenende stof overstiger 5 mg/m³. Må f.eks. ikke anvendes imod asbestfibre og kvartsstøv.

Varenr.	Max.	Standard	Class	DKK
DM21-1	4,5mg/m ³	EN 149:2001	P1	19,35

Beskyttelsesmaske P1

STOF



Masker kan beskytte alene mod faste partikler eller både mod faste partikler og væskeformige aerosoler. Er masken afprøvet efter EN149:2001, beskytter den både mod faste partikler og væskeformige aerosoler.

Klasse P1 har den laveste udskillelsesgrad af de klassificerede masker. En P1 maske må ikke bruges, hvis værdien for det forurenende stof overstiger 5 mg/m³. Må f.eks. ikke anvendes imod asbestfibre og kvartsstøv.

Varenr.	Max.	Standard	Class	DKK
DM23-1	4,5mg/m ³	EN 149:2001	P1	34,05

Med ventil

Beskyttelsesmaske P3

STOF



Masker kan beskytte alene mod faste partikler eller både mod faste partikler og væskeformige aerosoler. Er masken afprøvet efter EN149:2001, beskytter den både mod faste partikler og væskeformige aerosoler.

Klasse P3 har den største udskillelsesgrad op til 50 mg/m³ og beskytter som klasse P2 samt mod radioaktivt støv, bakterier og virus.

Varenr.	Max.	Standard	Class	DKK
DM25-1	50mg/m ³	EN 149:2001	P3	113,50

Med ventil

Beskyttelsesmaske P1 STOF



Masker kan beskytte alene mod faste partikler eller både mod faste partikler og væskeformige aerosoler. Er masken afprøvet efter EN149:2001, beskytter den både mod faste partikler og væskeformige aerosoler.

Klasse P1 har den laveste udskillelsesgrad af de klassificerede masker. En P1 maske må ikke bruges, hvis værdien for det forurenende stof overstiger 5 mg/m³. Må f.eks. ikke anvendes imod asbestfibre og kvartsstøv.

Varenr.	Max.	Standard	Class	DKK
DM26-1	4,5mg/m ³	EN 149:2001	P1	33,30

Foldemaske med ventil

Beskyttelsesmaske GUMMI

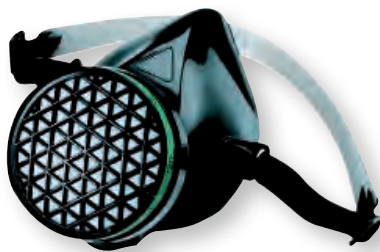

Varenr.	Filter	Standard	DKK
DM27-1	DM29	EN 140/141379,25	

Excl. filter

Beskyttelsesmaske GUMMI



Varenr.	Type	Standard	DKK
DM28-1	DM29	EN 140/141417,50	

Excl. filtre. Finjusterbar

Filter til DM27/28



Varenr.	Type	Standard	DKK
DM29-1	A	EN 141	114,25
DM29-2	B	EN 141	209,75
DM29-3	K	EN 141	230,00
DM29-4	P2S	EN 141	162,00
DM29-5	ABEK1P3	EN 141	546,25 α

α = kun til DM28-1

A = organiske dampe
B = gas
K = ammoniak
P2S = støv og røg
ABEK1P3 = alsidig

Sikkerhedshjelm PE (POLYETHYLEN)



Beskytter mod faldende objekter (-10° til +50°C) og el (max 400V AC). Remmen er justerbar, antisved og antiallergisk.

Varenr.	Farve/color	Standard	DKK
DM35-1	Hvid/white	EN 397	67,75
DM35-2	Gul/yellow	EN 397	67,75
DM35-3	Rød/red	EN 397	67,75
DM35-4	Blå/blue	EN 397	67,75

Sikkerhedshjelm PE (POLYETHYLEN)



Beskytter mod faldende objekter (-10° til +50°C) og el (max 400V AC). Remmen er trinløst justerbar og antisved og antiallergisk.

Varenr.	Farve/color	Standard	DKK
DM36-1	Hvid/white	EN 397	144,75
DM36-2	Gul/yellow	EN 397	144,75
DM36-3	Rød/red	EN 397	144,75
DM36-4	Blå/blue	EN 397	144,75

Beskyttelsesbrille

PLAST



Panoramaglas. Direkte ventilation i form af huller. Bruges ved risiko for flyvende partikler og sprøjtende væske.

Varenr.	Farve/color	DKK
DM90-1	Klar/clear	33,30

Beskyttelsesbrille

PC (POLYCARBONAT)



Ventilation via slidser i stængerne. Bruges ved risiko for flyvende partikler. Kan bruges sammen med almindelig brille.

Varenr.	Farve/color	Standard	DKK
DM93-1	Grøn/green	EN 166	78,90

Beskyttelsesbrille

PC (POLYCARBONAT)



Gråt glas, sort/orange stel. Silicone gummi på stænger v/ørerne. Bruges ved risiko for flyvende partikler. Kan bruges som sportsbrille.

Varenr.	Farve/color	Standard	DKK
DM96-1	Grå/grey	EN 166	174,00

Beskyttelsesbrille

PVC (POLYVINYLCHLORID)

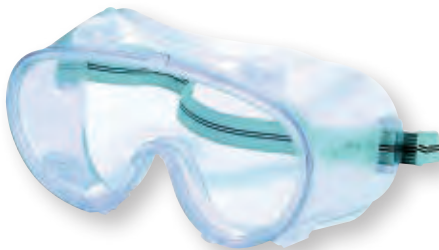

Panoramaglas. Indirekte ventilation via 4 ventiler. Bruges ved risiko for flyvende partikler og sprøjtende væske.

Varenr.	Farve/color	Standard	DKK
DM91-1	Klar/clear	EN 166	98,30

Beskyttelsesbrille

PC (POLYCARBONAT)



Klart glas, sorte, justerbare stænger. Sidebeskyttelse. Næsepuder af silicone gummi. Bruges ved risiko for flyvende partikler.

Varenr.	Farve/color	Standard	DKK
DM94-1	Klar/clear	EN 166	166,75

Beskyttelsesbrille

PC (POLYCARBONAT)

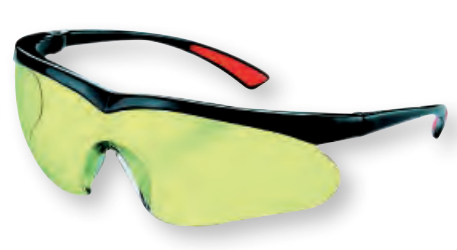

Gult glas, sort/orange stel. Silicone gummi på stænger v/ørerne. Bruges ved risiko for flyvende partikler. Kan bruges som sportsbrille.

Varenr.	Farve/color	Standard	DKK
DM97-1	Gul/yellow	EN 166	174,00

Beskyttelsesbrille

PC (POLYCARBONAT)



Ventilation via slidser i stængerne. Bruges ved risiko for flyvende partikler. Kan bruges sammen med almindelig brille.

Varenr.	Farve/color	Standard	DKK
DM92-1	Klar/clear	EN 166	78,90

Beskyttelsesbrille

PC (POLYCARBONAT)



Klart glas, sort/orange stel. Silicone gummi på stænger v/ørerne. Bruges ved risiko for flyvende partikler. Kan bruges som sportsbrille.

Varenr.	Farve/color	Standard	DKK
DM95-1	Klar/clear	EN 166	174,00

ARBEJDSHANDSKER



CE godkendt

ARBEJDSHANDSKER

EN388 er en standard, der evaluerer arbejdshandsker på fire punkter, i denne rækkefølge:

Slid - Skær (m. kniv) - Riv - Stik

Hvert punkt får en karakter fra 1 (lavest) til 4, undtagen Skær, der går til 5. Et X betyder, at producenten finder punktet irrelevant.

Hvor vigtigt et punkt er, afhænger selvfølgelig af hvad handsken skal bruges til, men en handske med max i alle punkter ville se således ud: EN388: 4544

Håndrens



Hudvenlig håndrens, drøj i brug. Med fint slibemiddel, der uden besvær fjerner fastsiddende snavs, som fedt, tjære, olie, farver etc.

Varenr.	Vol.	DKK
774545025	250 ml	63,65

Handske

SVINERUSKIND



Manchet og hånddryg i bomuld. Knopstring. Til let arbejde, vedligehold, lager, DIY, landbrug. Ikke til væske, olie og fedt.

Varenr.	Str.	EN388:	DKK
DM40-10	10	3112	28,10

Handske

OKSERUSKIND



Forstærket. Hånddryg i bomuld. Knopstring. Sikkerhedsmanchet. Til tungere arbejde. Ikke til væske, olie og fedt.

Varenr.	Str.	EN388:	DKK
DM42-10	10	3132	44,60

Handske Ninja Maxim

NYLON / SPANDEX



Tynd, sømløs og slidstærk handske med ribkrave. Nitrilbelægning i håndflade og på fingerspidser.

Anvendelse: Monteringsopgaver, elektronik lagerarbejde, pakning og inspektion.

Produceret iht. Öko-Tex Standard 100.

Varenr.	Str.	EN388:	DKK
DM98-5	5	4141	49,25
DM98-6	6	4141	49,25
DM98-7	7	4141	49,25
DM98-8	8	4141	49,25
DM98-9	9	4141	49,25
DM98-10	10	4141	49,25
DM98-11	11	4141	49,25

Handske

OKSERUSKIND



Manchet og hånddryg i bomuld. Knopstring. Til let arbejde, vedligehold, montage, industri. Ikke til væske, olie og fedt.

Varenr.	Str.	EN388:	DKK
DM41-10	10	3122	26,70

Handske

OKSERUSKIND



Forstærket. Hånddryg i bomuld. Knopstring. Sikkerhedsmanchet. Til byggeri og diverse arbejde. Ikke til væske, olie og fedt.

Varenr.	Str.	EN388:	DKK
DM43-10	10	3122	42,65

Handske FÅRESKIND



Håndryg i bomuld. Elastik i manchet. Til let arbejde, der kræver høj følsomhed, vedligehold, montering. Ikke til væske, olie og fedt.

Varenr.	Str.	EN388:	DKK
DM44-7	7	3111	72,40
DM44-8	8	3111	72,65
DM44-9	9	3111	72,65

Handske OKSERUSKIND



Læderforstærket syning og fuld foring gør den brandmodstandsdygtig og ideel til håndtering af varme genstande og svejsearbejde.

EN 407: 413X4X

Varenr.	Str.	EN388:	DKK
DM47-10	10	4144	97,45

Handske NYLON / PU (POLYURETHAN)



Håndflade belagt med hvid polyurethan. Smidig med godt greb og komfort. Til montage, andet let arbejde og præcisionsarbejde.

Varenr.	Str.	EN388:	DKK
DM50-8	8	3131	29,00
DM50-9	9	3131	29,00
DM50-10	10	3131	29,00

Handske OKSEHUD



Elastik i manchet. Til industri, montage, vedligehold, lastning og losning med moderat snitrisiko. Ikke til væske, olie og fedt.

Varenr.	Str.	EN388:	DKK
DM45-8	8	1121	103,00
DM45-9	9	1121	103,00
DM45-10	10	1121	103,00

Handske BOMULD / PVC (POLYVINYLCHLORID)



Sorte PVC dupper på håndfladen. Elastisk manchet. God slidstyrke og godt greb. Til let arbejde, havearbejde, landbrug. Ikke til væske, olie og fedt.

Varenr.	Str.	DKK
DM48-8	8,5	10,05
DM48-9	9,5	10,05
DM48-10	10	10,05
DM48-11	11	10,05

Handske NYLON / PU (POLYURETHAN)



Håndflade belagt med blå polyurethan. Smidig med godt greb og komfort. Til montage, andet let arbejde og præcisionsarbejde.

Varenr.	Str.	EN388:	DKK
DM51-7	7	3121	42,90
DM51-8	8	3121	42,90
DM51-9	9	3121	42,90
DM51-10	10	3121	42,90

Handske OKSEHUD



Elastik i manchet. Til industri, montage, vedligehold, lastning og losning med moderat snitrisiko. Ikke til væske, olie og fedt.

Varenr.	Str.	EN388:	DKK
DM46-8	8	2122	119,50
DM46-9	9	2122	119,50
DM46-10	10	2122	119,50

Handske NYLON / PVC (POLYVINYLCHLORID)



Blå PVC dupper på håndfladen. Elastisk manchet. Til arbejde, hvor det er nødvendigt med god føling og max greb.

Varenr.	Str.	EN388:	DKK
DM49-6	6	3143	48,05
DM49-8	8	3143	48,05
DM49-9	9	3143	48,05
DM49-10	10	3143	47,45

Handske BOMULD / NITRIL



Håndflade og fingre belagt med gul nitril. Elastisk manchet. Godt greb og god slidstyrke. Til industrielt arbejde m. forekomst af olie og fedt.

Varenr.	Str.	EN388:	DKK
DM52-7	7	3111	20,00
DM52-8	8	3111	20,25
DM52-9	9	3111	20,25
DM52-10	10	3111	20,25

Handske NYLON / NITRIL



Håndflade belagt med sort nitril. Elastisk manchet. Høj slidstyrke. Til industri, værksted og håndtering af små olierede dele.

Varenr.	Str.	EN388:	DKK
DM53-8	8	4121	31,05
DM53-9	9	4121	31,05
DM53-10	10	4121	31,05

Handske NYLON / NITRIL



Håndflade og fingre belagt med grå nitril. Elastisk manchet. Høj slidstyrke. Til industri, værksted og håndtering af små olierede dele.

Varenr.	Str.	EN388:	DKK
DM55-7	7	4121	81,65
DM55-8	8	4121	81,65
DM55-9	9	4121	81,65
DM55-10	10	4121	81,65

Handske BOMULD / NITRIL



Håndflade og fingre belagt med blå nitril. Sikkerhedsmanchet. Godt greb og god slidstyrke. Til tungere arbejde m. forekomst af olie og fedt.

Varenr.	Str.	EN388:	DKK
DM58-9	9	3111	30,70
DM58-10	10	3111	30,70

Montagehandske NYLON / NITRIL



Håndflade belagt med sort nitril. Elastisk manchet. Godt greb og høj slidstyrke. Til industri, værksted og håndtering af små olierede dele.

Actifresh® behandlet for at forhindre irritationer, infektioner og svampe.

Varenr.	Str.	EN388:	DKK
DM39-7	7	420	37,10
DM39-8	8	420	37,10
DM39-9	9	420	37,10
DM39-10	10	420	37,10

Handske BOMULD / NITRIL



Håndflade og fingre belagt med blå nitril. Elastisk manchet. Godt greb og god slidstyrke. Til tungere arbejde m. forekomst af olie og fedt.

Varenr.	Str.	EN388:	DKK
DM56-8	8	3111	26,70
DM56-9	9	3111	26,70
DM56-10	10	3111	26,70

Handske BOMULD / NITRIL



Helbelagt (-manchet) med blå nitril. Sikkerhedsmanchet. Godt greb og god slidstyrke. Til tungere arbejde m. forekomst af olie og fedt.

Varenr.	Str.	EN388:	DKK
DM59-10	10	3111	33,80

Handske NYLON / NITRIL



Håndflade belagt med grå nitril. Elastisk manchet. Høj slidstyrke. Til industri, værksted og håndtering af små olierede dele.

Varenr.	Str.	EN388:	DKK
DM54-7	7	4121	68,85
DM54-8	8	4121	69,35
DM54-10	10	4121	69,35

Handske BOMULD / NITRIL



Helbelagt (-manchet) med blå nitril. Elastisk manchet. Godt greb og god slidstyrke. Til tungere arbejde m. forekomst af olie og fedt.

Varenr.	Str.	EN388:	DKK
DM57-10	10	3111	30,70

Handske BOMULD / NITRIL



Håndflade og fingre belagt med blå nitril. Elastisk manchet. Godt greb og god slidstyrke. Actifresh behandlet. Til tungere arbejde m. olie og fedt.

Varenr.	Str.	EN388:	DKK
DM60-10	10	4111	52,60

Handske

BOMULD / NITRIL



Helbelagt (-manchet) med blå nitril. Elastisk manchet. Godt greb og høj slidstyrke. Actifresh behandlet. Til tungere arbejde m. olie og fedt.

Varenr.	Str.	EN388:	DKK
DM61-10	10	4111	56,25

Handske

BOMULD / PVC (POLYVINYLCHLORID)



Helbelagt med rød PVC. SANITIZED mod bakterier og svamp. Beskytter mod syre, olie, kaustiske kemikalier og opløsningsmidler.

EN 374: AKL

Varenr.	Str.	EN388:	DKK
DM65-9	9	4121	62,30
DM65-10	10	4121	62,30

Handske

DYNEEMA / PU (POLYURETHAN)



Lavet af verdens stærkeste fiber, fremragende mod slitage, snit og riv. Elastisk manchet. PU på håndfladen giver perfekt greb på tørre og olierede overflader.

Varenr.	Str.	EN388:	DKK
DM68-6	6	4343	290,50
DM68-7	7	4343	290,50
DM68-8	8	4343	290,50
DM68-9	9	4343	290,50
DM68-10	10	4343	290,50
DM68-11	11	4343	290,50

Handske

BOMULD / NITRIL



Helbelagt (-manchet) med blå nitril. Sikkerhedsmanchet. Godt greb og høj slidstyrke. Actifresh behandlet. Til tungere arbejde m. olie og fedt.

Varenr.	Str.	EN388:	DKK
DM63-10	10	4111	57,10

Handske

POLYESTER / LATEX



Håndflade belagt med latex, hvilket giver god føling. Elastisk manchet. Anatomisk form giver god komfort. Bruges til håndtering af frosne varer.

Varenr.	Str.	EN388:	DKK
DM66-8	8	2141	79,20
DM66-9	9	2141	79,20
DM66-10	10	2141	79,20
DM66-11	11	2141	79,20

Handske

DYNEEMA / PU (POLYURETHAN)



Lavet af verdens stærkeste fiber, fremragende mod slitage, snit og riv. Elastisk manchet. PU på håndfladen giver perfekt greb på tørre og olierede overflader.

Varenr.	Str.	EN388:	DKK
DM69-7	7	4543	419,50
DM69-8	8	4543	419,50
DM69-9	9	4543	419,50
DM69-10	10	4543	419,50

Handske

BOMULD / PVC (POLYVINYLCHLORID)



Helbelagt med rød PVC. Beskytter mod syre, olie, kaustiske kemikalier og opløsningsmidler.

EN374: DKL

Varenr.	Str.	EN388:	DKK
DM64-10	10	3121	38,10

Handske

POLYESTER / KLOROPREN



Vibrationsdæmpende kloroprenbelagt håndflade. Elastisk manchet. Til arbejde med værktøjsmaskiner og lufthamre i byggeriet.

Varenr.	Str.	EN388:	DKK
DM67-9	9	X243	372,75

Handske

SYNTETISK



Forstærket håndflade og fingerspidser. Dobbelt søm. Knopstring. Svedabsorbende. Elastisk manchet. Vaskbar. Behagelig og åndbar.

Varenr.	Str.	DKK
DM72-8	8	379,25
DM72-9	9	379,25

Handske SYNTEISK



Forstærket håndflade og fingerspidser. Dobbeltsøm. Knopolstring. Svedabsorberende. Manchet m. velcroluk. Vaskbar. Behagelig og åndbar.

Varenr.	Str.	DKK
DM73-8	8	399,75
DM73-9	9	399,75

Handske BOMULD / POLYESTER



Håndflade belagt med latex. Elastisk manchet. Fremragende følsomhed. Til byggeri og håndtering af olierede dele.

Varenr.	Str.	EN388:	DKK
DM76-8	8	2243	37,50
DM76-9	9	2243	37,50
DM76-10	10	2243	37,50

Handske NITRIL-LATEX



Meget god slidstyrke. Skridsikker overflade for bedre greb. Til arbejde m. opløsningsmidler, alkoholer, maling og lak.

Varenr.	Str.	EN388:	DKK
DM79-7	7	3101	45,45
DM79-8	8	3101	45,45
DM79-9	9	3101	45,45
DM79-10	10	3101	45,45

Handske DYRESKIND / SYNTEISK



Syntetisk hånddryg. Dobbeltsøm. Elastik i manchet. Meget behagelig og åndbar. Til arbejde, som kræver høj følsomhed og præcision.

Varenr.	Str.	DKK
DM74-8	8	345,00
DM74-9	9	345,00

Handske NATURLATEX



Til let vedligeholdelse, rengøring og husholdning.

Varenr.	Str.	DKK
DM77-7	7	15,10
DM77-8	8	15,10
DM77-9	9	15,10
DM77-10	10	15,10

Handske NATURLATEX



Skridsikker overflade på håndflade og fingre. God slidstyrke og følsomhed. Til kemisk og petrokemisk industri.

Varenr.	Str.	EN388:	DKK
DM80-8	8-8,5	3131	58,75
DM80-9	9-9,5	3131	58,75

Handske DYRESKIND / SYNTEISK



Syntetisk hånddryg og forstærkninger. Knopolstring. Dobbeltsøm. Manchet m. velcroluk. Behagelig og åndbar. Fin følsomhed og præcision.

Varenr.	Str.	DKK
DM75-8	8	393,00
DM75-9	9	393,00

Handske NATURLATEX



God slidstyrke. Ru yderside forbedrer grebet. Til let vedligeholdelse og montage, byggeri, landbrug, fiskeri.

Varenr.	Str.	DKK
DM78-7	7	22,40
DM78-8	8	22,40
DM78-9	9	22,40
DM78-10	10	22,40

Handske NEOPREN



Skridsikker overflade. Høj slidstyrke og fremragende fleksibilitet. Til kemisk og petrokemisk industri.

Varenr.	Str.	EN388:	DKK
DM81-8	8	3121	51,40
DM81-9	9	3121	51,40
DM81-10	10	3121	51,40

Engangshandske klar

VINYL



Meget fleksibel og elastisk. Til arbejde m. maling, tryksværte og lim, inspektion, rengøring, medicinsk personale, frisør, præcisionsarbejde.

Varenr.	Str.	DKK
DM82-7	7	122,00
DM82-8	8	122,00
DM82-9	9	122,00
DM82-10	10	122,00

Pris pr. kasse: 100 stk

Engangshandske blå

NITRIL



God slidstyrke og beskyttelse. Til brug i kemisk industri, laboratorier og elektronisk montage, dyreklinik.

Varenr.	Str.	DKK
DM84-8	8	229,00
DM84-9	9	229,00
DM84-10	10	229,00

Pris pr. kasse: 100 stk

Engangshandske

LATEX



Meget fleksibel og elastisk. Perfekt tilpasset hånden. Til brug i laboratorier, farmaceutisk industri, medicinsk brug, grafisk branche og frisør.

Varenr.	Str.	DKK
DM83-7	7	148,75
DM83-8	8	148,75
DM83-9	9	148,75
DM83-10	10	148,75

Pris pr. kasse: 100 stk

SLUSER OG MÅTTER



I dette afsnit findes produkter, der kan have en afgørende indflydelse på arbejdsmiljøet.

Sluser kan hindre træk, kulde og støj, mens måtter kan gøre underværker for stående arbejde.



Forhæng standard 50m PVC (POLYVINYLCHLORID)

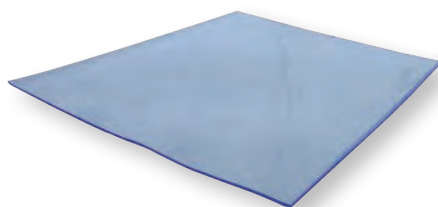

Varenr.	L	- -	- -	DKK
DA50-200	50m	0,2m	2mm	2966,50
DA50-300	50m	0,3m	2mm	4471,25
DA50-400	50m	0,4m	3mm	8393,50

Forhæng frys 50m PVC (POLYVINYLCHLORID)

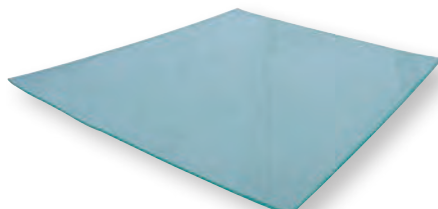

Varenr.	L	- -	- -	DKK
DA51-200	50m	0,2m	2mm	3064,25
DA51-300	50m	0,3m	3mm	5879,25

Til -40°C

Forhæng svejs 50m PVC (POLYVINYLCHLORID)

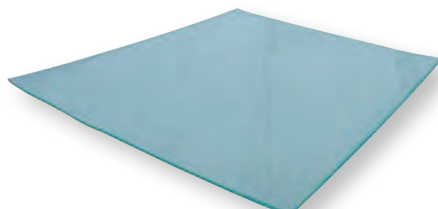

Varenr.	L	- -	- -	DKK
DA52-200	50m	0,2m	2mm	3162,25
DA52-300	50m	0,3m	2mm	4773,25

Hængselbeslag AISI 316

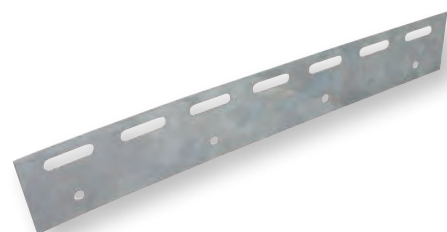

Varenr.	- -	DKK
DA61-200	0,2m	52,60
DA61-300	0,3m	73,15
DA61-400	0,4m	133,50

Skruehulstørrelse = 5,1mm

Loftskinne AISI 316

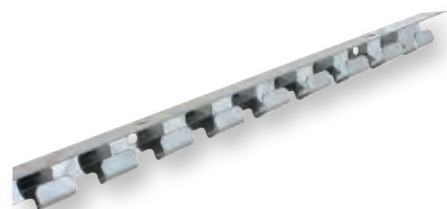

Varenr.	- -	DKK
DA60-1	1m	424,75

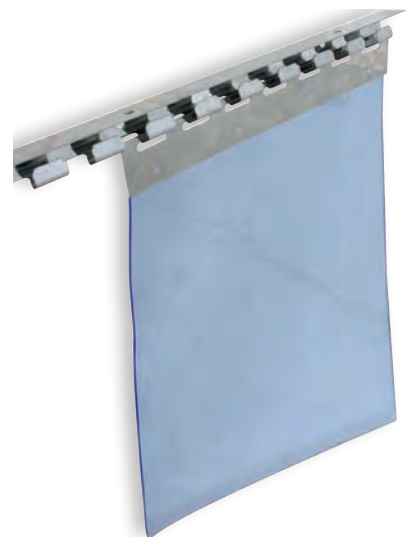

Gummimåtte

SBR



Varenr.	L	-	- -	DKK
DA65-1	0,6m	0,4m	23mm	81,10
DA65-2	1,2m	0,8m	23mm	418,50
DA65-3	1,5m	1m	23mm	704,25

-40° til +100°C

Ergomåtte, skridtern

NBR

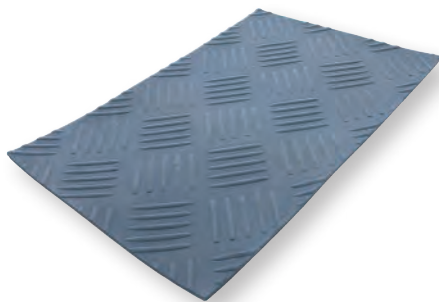

Varenr.	L	-	- -	DKK
DA70-1	10m	1,4m	3mm	4104,75

Olie/syrebestandig, -40° til +120°C

Ergomåtte, diamanter

NBR

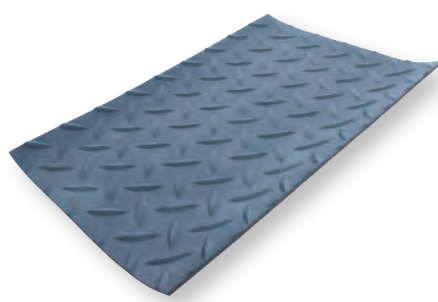

Varenr.	L	-	- -	DKK
DA72-1	10m	1,5m	3mm	2291,75

Olie/syrebestandig, -40° til +120°C

Samlestykke til DA65

SBR



Varenr.	-	DKK
DA65-4	-	8,20

Ergomåtte, dupper

NBR

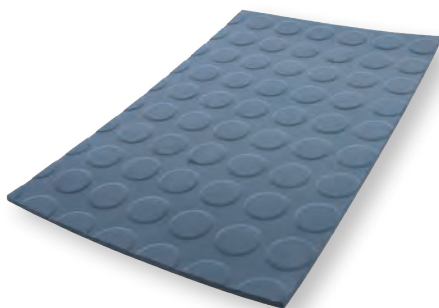

Varenr.	L	-	- -	DKK
DA71-1	10m	1,2m	3mm	2756,50

Olie/syrebestandig, -40° til +120°C

Ergomåtte, riller

NBR

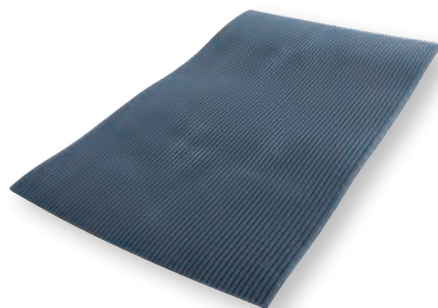

Varenr.	L	-	- -	DKK
DA73-1	10m	1,2m	3mm	2153,75

Olie/syrebestandig, -40° til +120°C

MÅTTER

Ergomåtter, med forskellige mønstre og egenskaber, der kan aflaste ansattes bevægeapparat, kan hurtigt vise sig at være en rigtig god investering. Og hvorfor?

Fordi en fjerdedel af alt arbejde udføres gående eller stående, typisk stillestående.

Denne form for arbejde påvirker de muskler og led, der står for vores mobilitet og som viser sig at være skyld i over halvdelen af arbejdspladsrelaterede sygedage.

Så ved at investere i ergomåtter, der afhjælper problemet, kan investeringen lynhurtigt vise sig at være tjent ind igen.

VAND & SPILDEVAND



644 VAND:
SKYDEVENTILER



648 VAND:
SKYDEVENTILER TILBEHØR



650 VAND:
BUTTERFLYVENTILER



655 SPILDEVAND:
SKYDEVENTILER



658 SPILDEVAND:
SKYDEVENTILER TILBEHØR



660 SPILDEVAND:
SPADEVENTILER



664 SPILDEVAND:
KONTRAVENTILER



671 KUGLEHANER
RUSTFRI



676 AKTUATORER OG
TILBEHØR



678 KOBLINGER TIL VAND
OG SPILDEVAND



682 KOBLINGER
RUSTFRI TIL VA



685 ANBORINGER



687 KOMPENSATORER



689 STØBEJERNSFITTINGS



697 UDLØBSKLAPPER



699 PAKNINGER TIL VAND
OG SPILDEVAND



701 RØRGENNEMFØRINGER



707 RENSEGRISE

VAND: SKYDEVENTILER



PN10-16



Max. 70°C



EN1171, EN12266-1:2003
Flanger iht. DIN EN1092-2



Stort program af blødtættende skydeventiler. Alle malede ventiler er coatet med RAL5005 epoxy belægning min. 250 micron (korrosionsklasse 4). Ventilerne har et meget lavt drejningsmoment, der sikrer ekstremt nem åbning og lukning.

Alle større ventiler er monteret med hejsekroge for nem håndtering.

For yderligere information, se datablad.

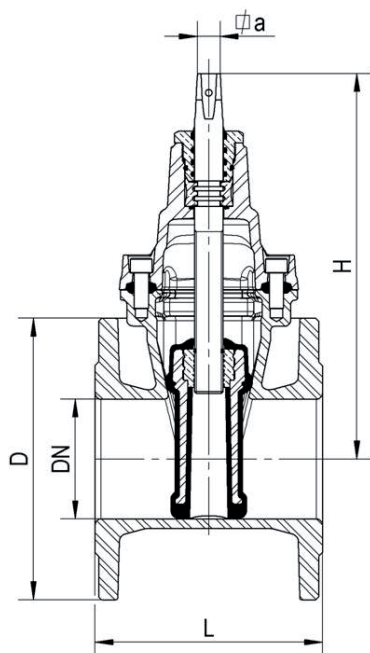

Spindel tætnings detaljer

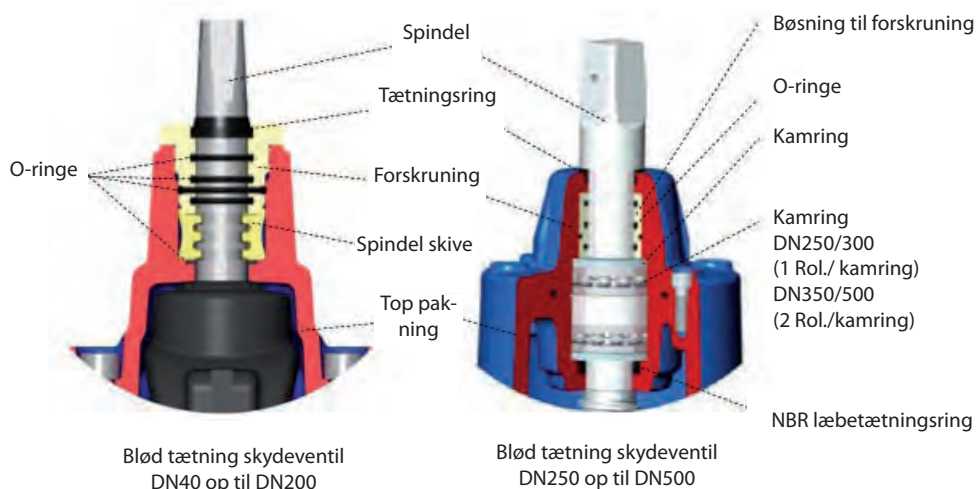

Blød tætning skydeventil
DN40 op til DN200

Blød tætning skydeventil
DN250 op til DN500



Certifikat: **ISO 14001** og **ISO 9001**

Skydeventil 316

DUKTILJERN



Duktilt støbejerns skydeventil **til vand** i F4 byggemål med håndhjul og DIN PN10 flanger.
KIWA drikkevandsgodkendt.
Bemærk: 15 års garanti.

Spindel = AISI 316, skyder = EPDM

Varenr.	DN	Byg L	Håndhjul	DKK
OP10-40-EH	40	140	Ø200 - 14	2104,50
OP10-50-EH	50	150	Ø200 - 14	2169,25
OP10-65-EH	65	170	Ø225 - 17	1834,50
OP10-80-EH	80	180	Ø225 - 17	1848,00
OP10-100-EH	100	190	Ø260 - 19	2442,25
OP10-125-EH	125	200	Ø260 - 19	3652,50
OP10-150-EH	150	210	Ø260 - 19	3977,00
OP10-200-EH	200	230	Ø380 - 24	7370,75
OP10-250-EH	250	250	Ø500 - 27	11448,50
OP10-300-EH	300	270	Ø600 - 27	18916,00
OP10-350-EH	350	290	Ø800 - 32	38980,50
OP10-400-EH	400	310	Ø800 - 32	50387,75
OP10-450-EH	450	330	Ø800 - 32	82977,00
OP10-500-EH	500	350	Ø800 - 32	89872,75

Skydeventil ISO top

DUKTILJERN



Duktilt støbejerns skydeventil **til vand** i F4 byggemål med DIN PN10 flanger og ISO top.
Bemærk: 15 års garanti.

Spindel = AISI 316, skyder = EPDM

Varenr.	DN	Byg L	ISO top	DKK
OP20-40-E	40	140	F10	2508,00
OP20-50-E	50	150	F10	2508,00
OP20-65-E	65	170	F10	2569,00
OP20-80-E	80	180	F10	2631,00
OP20-100-E	100	190	F10	2692,00
OP20-125-E	125	200	F10	3917,00
OP20-150-E	150	210	F10	4404,00
OP20-200-E	200	230	F10	7785,00
OP20-250-E	250	250	F14	11655,00
OP20-300-E	300	270	F14	20570,00
OP20-350-E	350	290	F14	50275,00
OP20-400-E	400	310	F14	65825,00
OP20-450-E	450	330	F14	110195,00
OP20-500-E	500	350	F14	119405,00

MOMENT FOR AT DREJE SPINDELEN

Ventilstørrelse	Åben/luk nM
DN080	60
DN100	80
DN125	90
DN150	100
DN200	120
DN250	150
DN300	200
DN350	300
DN400	300
DN450	400
DN500	400

Skydeventil 316 m. PE ben

DUKTILJERN



Skydeventil i duktilt støbejern **til vand** med PE ben.
KIWA drikkevandsgodkendt.

Spindel = AISI 316, skyder = EPDM

Varenr.	DN ~ Ø	Byg L	Spindeltop	DKK
OP50-25-E	25 ~ 32	800	13	1981,75
OP50-32-E	32 ~ 40	850	13	2266,00
OP50-40-E	40 ~ 50	880	13	2390,75
OP50-50-E	50 ~ 63	880	14	3492,75
OP50-65-E	65 ~ 75	880	17	4025,25
OP50-80-E	80 ~ 90	950	17	4951,25
OP50-100-E	100 ~ 110	975	19	5824,75
OP50-125-E	125 ~ 125	1100	19	7719,00
OP50-125-2-E	125 ~ 140	1100	19	11402,25
OP50-150-E	150 ~ 160	1100	19	11752,50
OP50-150-2-E	150 ~ 180	1100	19	12715,50
OP50-200-E	200 ~ 200	1200	24	18334,00
OP50-200-2-E	200 ~ 225	1200	24	23170,00
OP50-250-E	250 ~ 250	1260	27	28809,25
OP50-250-2-E	250 ~ 280	1260	27	39639,75
OP50-300-E	300 ~ 315	1600	27	53719,75
OP50-400-E	400 ~ 400	1700	32	96021,75

L1=300mm for alle

Stikledningsventil muf/muf

DUKTILJERN



Stikledningsventil i duktilt støbejern **til vand** med indvendige gevindender.
KIWA drikkevandsgodkendt.

Spindel = AISI 316, skyder = EPDM

Varenr.	DN ~ BSPP	Byg L	Spindeltop	DKK
OP40-20-E	20 ~ 3/4"	100	13	1052,75
OP40-25-E	25 ~ 1"	115	13	1052,75
OP40-32-E	32 ~ 1 1/4"	130	13	1204,25
OP40-40-E	40 ~ 1 1/2"	150	13	1517,25
OP40-50-E	50 ~ 2"	180	13	1878,75

Stikledningsventil indstik

DUKTILJERN



Stikledningsventil i duktilt støbejern **til vand** med trækfaste indstiksmuffer.
KIWA drikkevandsgodkendt.

Spindel = AISI 316, skyder = EPDM

Varenr.	DN ~ Ø	Byg L	Spindeltop	DKK
OP42-20-E	20 ~ 25	165	13	895,50
OP42-25-E	25 ~ 32	185	13	895,50
OP42-32-E	32 ~ 40	205	13	1127,00
OP42-40-E	40 ~ 50	255	13	1321,50
OP42-50-E	50 ~ 63	300	13	1651,25

Stikledningsventil 90° nip/indstik

DUKTILJERN



Stikledningsventil i duktilt støbejern **til vand** med 1 90° vinkel med udv. gevind og 1 trækfast indstiksmuffe. KIWA drikkevandsgodkendt.

Spindel = AISI 316, skyder = EPDM

Varenr.	DN ~ Ø × BSPT	Byg L	Spindeltop	DKK
OP44-25-E	25 ~ 32 × 11/4"	92,5/31	13	1503,00
OP44-32-E	32 ~ 40 × 2"	102,5/37	13	1385,50
OP44-40-E	40 ~ 50 × 2"	127,5/42	13	1749,00
OP44-50-E	50 ~ 63 × 2"	150,0/50	13	2433,00

Skydeventil til PVC

DUKTILJERN



Skydeventil i duktilt støbejern **til vand** med muffe for PVC rør. KIWA drikkevandsgodkendt.

Spindel = AISI 316, skyder = EPDM

Varenr.	DN ~ Ø	Byg L	Spindeltop	DKK
OP60-40-E	40 ~ 50	220	14	2254,75
OP60-50-E	50 ~ 63	250	14	2254,75
OP60-65-E	65 ~ 75	270	17	2216,75
OP60-80-E	80 ~ 90	280	17	1864,50
OP60-100-E	100 ~ 110	300	19	2323,75
OP60-125-E	125 ~ 125	325	19	5475,50
OP60-125-2-E	125 ~ 140	325	19	5475,50
OP60-150-E	150 ~ 160	350	19	3755,50
OP60-200-E	200 ~ 200	400	24	9996,25
OP60-250-E	250 ~ 250	450	27	17932,50
OP60-300-E	300 ~ 315	490	27	28829,75
OP60-400-E	400 ~ 400	640	32	59189,00
OP60-500-E	500 ~ 500	700	32	107367,25

Stikledningsventil nip/indstik

DUKTILJERN



Stikledningsventil i duktilt støbejern **til vand** med 1 gevindende med udv. gevind og 1 trækfast indstiksmuffe. KIWA drikkevandsgodkendt.

Spindel = AISI 316, skyder = EPDM

Varenr.	DN ~ Ø × BSPT	Byg L	Spindeltop	DKK
OP46-25-E	25 ~ 32 × 1"	172,5	13	1501,75
OP46-32-E	32 ~ 40 × 11/4"	194,5	13	1514,25
OP46-40-E	40 ~ 50 × 11/2"	219,5	13	2101,25
OP46-50-E	50 ~ 63 × 2"	253,0	13	2331,00

VAND: SKYDEVENTILER TILBEHØR



Universelt garniture og tilbehør som passer til flere modeller af skydeventiler.

Teleskopforlænger



Varenr.	DN	Extra	DKK
OP90-1-70	25-50	+ 50-70cm	488,50
OP90-1-110	25-50	+ 65-110cm	521,50
OP90-1-175	25-50	+ 105-175cm	554,00
OP90-1-235	25-50	+ 140-235cm	651,75
OP90-1-290	25-50	+ 170-290cm	717,00
OP90-1-525	25-50	+ 285-525cm	1075,50
OP90-2-70	40-150	+ 50-70cm	780,75
OP90-2-110	40-150	+ 65-110cm	845,75
OP90-2-175	40-150	+ 105-175cm	1466,75
OP90-2-290	40-150	+ 170-290cm	1304,00
OP90-3-65	200-400	+ 45-65cm	461,25 α
OP90-3-70	200-400	+ 50-70cm	1115,50
OP90-3-110	200-400	+ 65-110cm	1288,75
OP90-3-175	200-400	+ 105-175cm	1527,50
OP90-3-235	200-400	+ 140-235cm	1566,75
OP90-3-290	200-400	+ 170-290cm	1720,25

α = så længe lager havet

Spindelsamler til teleskop



Varenr.	DN	dim	DKK
OP91-32	25/32	12	97,70
OP91-32-1	25/32	13	114,25
OP91-50	40/50	13/14	155,00
OP91-80	65/80	17	155,00
OP91-150	100/150	19	174,25
OP91-200	175/200	24	187,75
OP91-300	250/300	27	260,75
OP91-500	350/500	32	391,00

Topadapter



Varenr.	DN	DKK
OP93-50	40-50	152,75
OP93-80	65-80	152,75
OP93-150	100-160	152,75
OP93-200	200	179,25
OP93-300	250-300	204,50
OP93-500	350-500	330,50

Bæreplade



Varenr.	dim	DKK
OP92-1	-	116,75

Håndhjul DUKTILJERN



Varenr.	DN	dim	DKK
OP94-50	40/50	Ø200 - 14	751,75
OP94-80	65/80	Ø225 - 17	290,75
OP94-150	100/150	Ø260 - 19	285,75
OP94-200	200	Ø380 - 24	425,50
OP94-250	250	Ø500 - 27	982,50
OP94-300	300	Ø600 - 27	1162,00
OP94-500	350/500	Ø800 - 32	1435,25

Fikseringsplade



Varenr.	dim	DKK
OP92-2	-	15,10

Traktorgreb



Varenr.	dim	DKK
OP95-1	-	467,25

Dæksel



Varenr.	dim	DKK
OP92-3	-	346,00

VAND: BUTTERFLYVENTILER



PN10-16



Max. 110°C



Fås som både Wafer og Lug type. Er velegnede til regulering og fås med el- og pneumatiske aktuatorer.

Butterflyventil wafer

DUKTILJERN



Wafer-type butterflyventil **til vand**. Lavet af duktilt støbejern. Passer til DIN PN10 flanger. Med håndtag.

Klap = AISI 316, pakning = EPDM

Varenr.	DN	Byg L	DKK
OP300-40-E	40	33	519,50
OP300-50-E	50	43	590,75
OP300-65-E	65	46	718,75
OP300-80-E	80	46	799,75
OP300-100-E	100	52	997,50
OP300-125-E	125	56	1430,75
OP300-150-E	150	56	1750,00
OP300-200-E	200	60	2728,50
OP300-250-E	250	68	4799,00
OP300-300-E	300	78	6701,25
OP300-350-E	350	78	9069,25
OP300-400-E	400	102	15583,00
OP300-450-E	450	114	22124,50
OP300-500-E	500	127	25549,25
OP300-600-E	600	154	51603,00

Butterflyventil m. gearbox

DUKTILJERN



Wafer-type butterflyventil **til vand**. Lavet af duktilt støbejern. Passer til DIN PN10 flanger. Med manuel gearbox.

Klap = AISI 316, pakning = EPDM

Varenr.	DN	Byg L	DKK
OP302-65-E	65	46	821,75
OP302-80-E	80	46	823,50
OP302-100-E	100	52	1086,75
OP302-125-E	125	56	1516,25
OP302-150-E	150	56	1835,50
OP302-200-E	200	60	2907,75
OP302-250-E	250	68	6727,00
OP302-300-E	300	78	8744,75
OP302-350-E	350	78	11108,75
OP302-400-E	400	102	18560,75
OP302-450-E	450	114	25410,25

Butterflyventil pneumatisk DUKTILJERN



Wafer-type butterflyventil **til vand**. Lavet af duktilt støbejern. Passer til DIN PN10 flanger.
Med pneumatisk aktuator.

Klap = AISI 316, pakning = EPDM

Varenr.	DN	Byg L	Motor	DKK
OP304-50-E	50	43	HAT63D	2074,50
OP304-65-E	65	46	HAT63D	2195,00
OP304-80-E	80	46	HAT75D	2851,25
OP304-100-E	100	52	HAT90D	3766,75
OP304-125-E	125	56	HAT100D	4853,50
OP304-150-E	150	56	HAT100D	5172,75
OP304-200-E	200	60	HAT125D	7806,50
OP304-250-E	250	68	HAT160D	14100,75
OP304-300-E	300	78	HAT190D	21362,25
OP304-400-E	400	102	HAT240D	43167,50

Spoileventil type Namur ALUMINIUM - BSPP

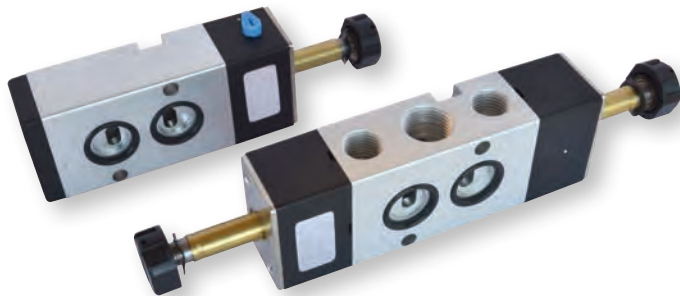

Varenr.	Port+Exh	Type	DKK
EV21-1	3 · 1/4"	16	402,00
EV21-2	1-3/8"+2-1/4"	16	402,00
EV21-3	3 · 1/4"	17	637,25
EV21-4	1-3/8"+2-1/4"	17	637,25
EV21-5	3 · 1/4"	21	1156,75
EV21-6	3 · 1/4"	23	1156,75
EV21-7	3 · 1/4"	22	1156,75
EV21-8	1-3/8"+2-1/4"	21	1156,75
EV21-9	1-3/8"+2-1/4"	23	1156,75
EV21-10	1-3/8"+2-1/4"	22	1156,75

Butterflyventil m. aktuator DUKTILJERN



Wafer-type butterflyventil **til vand**. Lavet af duktilt støbejern. Passer til DIN PN10 flanger.
Med elektrisk aktuator.

Klap = AISI 316, pakning = EPDM

Varenr.	DN	Byg L	Motor/volt	DKK
OP306-50-E	50	43	HL05S/230V	3608,25
OP306-65-E	65	46	HL05S/230V	3728,75
OP306-80-E	80	46	HL10S/230V	4749,50
OP306-100-E	100	52	HL10S/230V	5088,25
OP306-125-E	125	56	HL10S/230V	5609,50
OP306-150-E	150	56	HL20S/230V	6742,50
OP306-200-E	200	60	HL20S/230V	7889,00
OP308-50-E	50	43	HL05S/24V	3605,00
OP308-65-E	65	46	HL05S/24V	3725,75
OP308-80-E	80	46	HL10S/24V	4746,25
OP308-100-E	100	52	HL10S/24V	5010,00
OP308-125-E	125	56	HL10S/24V	5442,75
OP308-150-E	150	56	HL20S/24V	6572,50
OP308-200-E	200	60	HL20S/24V	7552,00

Coil+conn. m. LED til EV1/EV2



Varenr.	dim	Volt	DKK
EV5-1	M5	12 DC	135,75
EV5-2	M5	24 DC	135,75
EV5-3	M5	24 AC	135,75
EV5-4	M5	220 AC	135,75
EV5-5	M5	380 AC	135,75
EV5-6	1/8" - 1/2"	12 DC	135,75
EV5-7	1/8" - 1/2"	24 DC	135,75
EV5-8	1/8" - 1/2"	24 AC	135,75
EV5-9	1/8" - 1/2"	220 AC	135,75
EV5-10	1/8" - 1/2"	380 AC	135,75

Butterflyventil lug-type

DUKTILJERN



Lug-type butterflyventil i duktilt støbejern **til vand**. Passer til DIN PN10 flanger.
Med håndtag.

Klap = AISI 316, pakning = EPDM

Varenr.	DN	Byg L	DKK
OP350-40-E	40	33	1130,00
OP350-50-E	50	43	1095,00
OP350-65-E	65	46	1480,25
OP350-80-E	80	46	1720,25
OP350-100-E	100	52	2293,00
OP350-125-E	125	56	3149,75
OP350-150-E	150	56	3849,25
OP350-200-E	200	60	6534,50
OP350-250-E	250	68	11721,50
OP350-300-E	300	78	16658,25

Butterflyventil m. gearbox

DUKTILJERN



Lug-type butterflyventil i duktilt støbejern **til vand**. Passer til DIN PN10 flanger.
Med håndhjul og manuel gearbox.

Klap = AISI 316, pakning = EPDM

Varenr.	DN	Byg L	DKK
OP358-65-E	65	46	α
OP358-80-E	80	46	α
OP358-100-E	100	52	α
OP358-125-E	125	56	α
OP358-150-E	150	56	α
OP358-200-E	200	60	α
OP358-250-E	250	68	α
OP358-300-E	300	78	α
OP358-350-E	350	78	α
OP358-400-E	400	102	25702,75

α = spørg på pris

Butterflyventil pneumatisk

DUKTILJERN



Lug-type butterflyventil i duktilt støbejern **til vand**. Passer til DIN PN10 flanger.
Med pneumatisk aktuator.

Klap = AISI 316, pakning = EPDM

Varenr.	DN	Byg L	DKK
OP352-50-E	50	43	2539,00
OP352-65-E	65	46	2871,75
OP352-80-E	80	46	3761,75
OP352-100-E	100	52	5060,50
OP352-125-E	125	56	6365,50
OP352-150-E	150	56	7104,00
OP352-200-E	200	60	11469,25

Butterflyventil m. aktuator

DUKTILJERN



Lug-type butterflyventil i duktilt støbejern **til vand**. Passer til DIN PN10 flanger.
Med elektrisk aktuator.

Klap = AISI 316, pakning = EPDM

Varenr.	DN	Byg L	Motor/Volt	DKK
OP354-50-E	50	43	HL05S/230V	4212,75
OP354-65-E	65	46	HL05S/230V	4547,50
OP354-80-E	80	46	HL10S/230V	5732,00
OP354-100-E	100	52	HL10S/230V	6305,75
OP354-125-E	125	56	HL10S/230V	7118,50
OP354-150-E	150	56	HL20S/230V	8837,50
OP354-200-E	200	60	HL20S/230V	11531,00
OP356-50-E	50	43	HL05S/24V	4211,75
OP356-65-E	65	46	HL05S/24V	4546,50
OP356-80-E	80	46	HL10S/24V	5733,00
OP356-100-E	100	52	HL10S/24V	6303,75
OP356-125-E	125	56	HL10S/24V	7119,50
OP356-150-E	150	56	HL20S/24V	8672,75
OP356-200-E	200	60	HL20S/24V	11361,00

Spoleventil type Namur

ALUMINIUM - BSPP

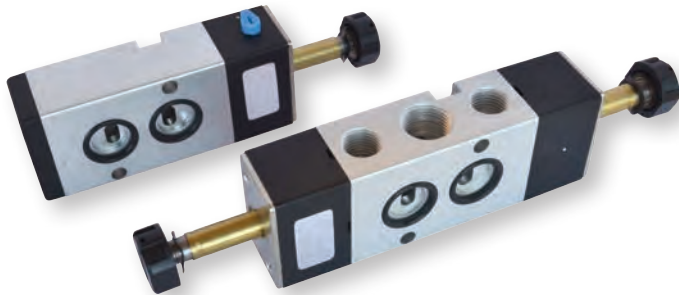

Varenr.	Port+Exh	Type	DKK
EV21-1	3 · 1/4"	16	402,00
EV21-2	1-3/8"+2-1/4"	16	402,00
EV21-3	3 · 1/4"	17	637,25
EV21-4	1-3/8"+2-1/4"	17	637,25
EV21-5	3 · 1/4"	21	1156,75
EV21-6	3 · 1/4"	23	1156,75
EV21-7	3 · 1/4"	22	1156,75
EV21-8	1-3/8"+2-1/4"	21	1156,75
EV21-9	1-3/8"+2-1/4"	23	1156,75
EV21-10	1-3/8"+2-1/4"	22	1156,75

Coil+conn. m. LED til EV1/EV2



Varenr.	dim	Volt	DKK
EV5-1	M5	12 DC	135,75
EV5-2	M5	24 DC	135,75
EV5-3	M5	24 AC	135,75
EV5-4	M5	220 AC	135,75
EV5-5	M5	380 AC	135,75
EV5-6	1/8" - 1/2"	12 DC	135,75
EV5-7	1/8" - 1/2"	24 DC	135,75
EV5-8	1/8" - 1/2"	24 AC	135,75
EV5-9	1/8" - 1/2"	220 AC	135,75
EV5-10	1/8" - 1/2"	380 AC	135,75

Butterflyventil excentrisk

DUKTILJERN

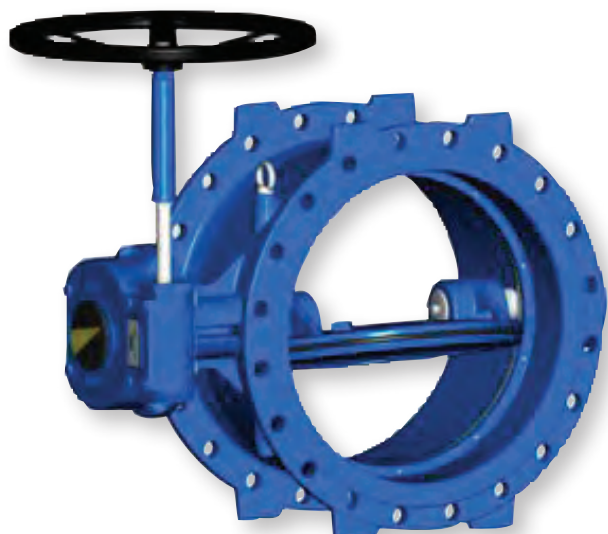

Excentrisk butterflyventil i duktilt støbejern **til vand** med DIN PN10 flanger.

Med håndhjul og manuel gearbox.

Sæde = AISI 316, pakning = EPDM

Varenr.	DN	Byg L	DKK
OP360-150-E	150	210	21135,75
OP360-200-E	200	230	21985,00
OP360-250-E	250	250	25971,50
OP360-300-E	300	270	29916,50
OP360-350-E	350	290	39866,25
OP360-400-E	400	310	45891,75
OP360-450-E	450	330	65817,00
OP360-500-E	500	350	72476,00
OP360-600-E	600	390	91562,00
OP360-700-E	700	430	136119,75
OP360-800-E	800	470	188964,00
OP360-900-E	900	510	238172,25
OP360-1000-E	1000	550	311343,25
OP360-1200-E	1200	630	492808,75

Manuel gearbox t. butterfly

DUKTILJERN



Varenr.	DN	DKK
OP390-1	25-150	764,25
OP390-2	200	1629,50
OP390-3	250-400	2031,25

SPILDEVAND: SKYDEVENTILER

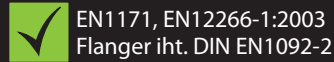

Stort program af blødtættende skydeventiler. Alle malede ventiler er coatet med RAL5005 epoxy belægning min. 250 micron (korrosionsklasse 4). Ventilene har et meget lavt drejningsmoment, der sikrer ekstremt nem åbning og lukning.

Alle større ventiler er monteret med hejsekroge for nem håndtering.

For yderligere information, se datablad.

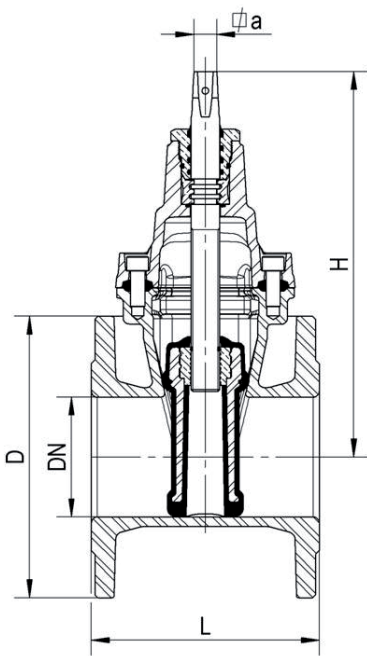

Spindel tætnings detaljer

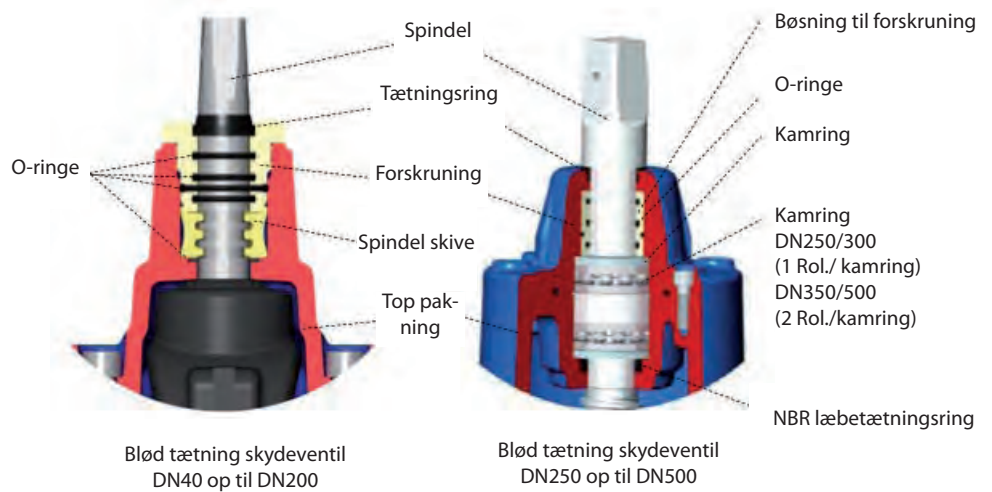

Certifikat: ISO 14001 og ISO 9001

Skydeventil 316

DUKTILJERN



Duktilt støbejerns skydeventil **til spildevand** i F4 byggemål med håndhjul og DIN PN10 flanger.
Bemærk: 15 års garanti.

Spindel = AISI 316, skyder = NBR

Varenr.	DN	Byg L	Håndhjul	DKK
OP10-40-NH	40	140	Ø200 - 14	1801,50
OP10-50-NH	50	150	Ø200 - 14	1932,50
OP10-65-NH	65	170	Ø225 - 17	2101,25
OP10-80-NH	80	180	Ø225 - 17	2204,25
OP10-100-NH	100	190	Ø260 - 19	2302,25
OP10-125-NH	125	200	Ø260 - 19	3501,00
OP10-150-NH	150	210	Ø260 - 19	3977,00
OP10-200-NH	200	230	Ø380 - 24	7370,75
OP10-250-NH	250	250	Ø500 - 27	12406,50
OP10-300-NH	300	270	Ø600 - 27	18169,25
OP10-350-NH	350	290	Ø800 - 32	35581,50
OP10-400-NH	400	310	Ø800 - 32	48229,75
OP10-450-NH	450	330	Ø800 - 32	75576,25
OP10-500-NH	500	350	Ø800 - 32	85861,00

Skydeventil 420

DUKTILJERN



Duktilt støbejerns skydeventil **til spildevand** i F4 byggemål med håndhjul og DIN PN10 flanger.
Bemærk: 15 års garanti.

Spindel = AISI 420, skyder = NBR

Varenr.	DN	Byg L	Håndhjul	DKK
OP11-65-NH	65	170	Ø225 - 17	UDGÅET
OP11-125-NH	125	200	Ø260 - 19	UDGÅET
OP11-200-NH	200	230	Ø380 - 24	UDGÅET
OP11-250-NH	250	250	Ø500 - 27	10954,25 α

α = så længe lager haves

Skydeventil m. ISO top

DUKTILJERN



Duktilt støbejerns skydeventil **til spildevand** i F4 byggemål med DIN PN10 flanger og ISO top.

Bemærk: 15 års garanti.

Spindel = AISI 316, skyder = NBR

Varenr.	DN	Byg L	ISO top	DKK
OP20-40-N	40	140	F10	2583,25
OP20-50-N	50	150	F10	2583,25
OP20-65-N	65	170	F10	2646,25
OP20-80-N	80	180	F10	2710,00
OP20-100-N	100	190	F10	2773,00
OP20-125-N	125	200	F10	4034,75
OP20-150-N	150	210	F10	4536,25
OP20-200-N	200	230	F10	8018,75
OP20-250-N	250	250	F14	12004,75
OP20-300-N	300	270	F14	21187,25
OP20-350-N	350	290	F14	51783,25
OP20-400-N	400	310	F14	67799,75
OP20-450-N	450	330	F14	113501,00
OP20-500-N	500	350	F14	122987,25

MOMENT FOR AT DREJE SPINDELEN

Ventilstørrelse	Åben/luk nM
DN080	60
DN100	80
DN125	90
DN150	100
DN200	120
DN250	150
DN300	200
DN350	300
DN400	300
DN450	400
DN500	400

SPILDEVAND: SKYDEVENTILER TILBEHØR



Universelt garniture og tilbehør som passer til flere modeller af skydeventiler.

Teleskopforlænger



Varenr.	DN	Extra	DKK
OP90-1-70	25-50	+ 50-70cm	488,50
OP90-1-110	25-50	+ 65-110cm	521,50
OP90-1-175	25-50	+ 105-175cm	554,00
OP90-1-235	25-50	+ 140-235cm	651,75
OP90-1-290	25-50	+ 170-290cm	717,00
OP90-1-525	25-50	+ 285-525cm	1075,50
OP90-2-70	40-150	+ 50-70cm	780,75
OP90-2-110	40-150	+ 65-110cm	845,75
OP90-2-175	40-150	+ 105-175cm	1466,75
OP90-2-290	40-150	+ 170-290cm	1304,00
OP90-3-65	200-400	+ 45-65cm	461,25 α
OP90-3-70	200-400	+ 50-70cm	1115,50
OP90-3-110	200-400	+ 65-110cm	1288,75
OP90-3-175	200-400	+ 105-175cm	1527,50
OP90-3-235	200-400	+ 140-235cm	1566,75
OP90-3-290	200-400	+ 170-290cm	1720,25

α = så længe lager haves

Spindelsamler til teleskop



Varenr.	DN	dim	DKK
OP91-32	25/32	12	97,70
OP91-32-1	25/32	13	114,25
OP91-50	40/50	13/14	155,00
OP91-80	65/80	17	155,00
OP91-150	100/150	19	174,25
OP91-200	175/200	24	187,75
OP91-300	250/300	27	260,75
OP91-500	350/500	32	391,00

Bæreplade



Varenr.	dim	DKK
OP92-1	-	116,75

Fikseringsplade



Varenr.	dim	DKK
OP92-2	-	15,10

Traktorgreb



Varenr.	dim	DKK
OP95-1	-	467,25

Dæksel



Varenr.	dim	DKK
OP92-3	-	346,00

Håndhjul DUKTILJERN



Varenr.	DN	dim	DKK
OP94-50	40/50	Ø200 - 14	751,75
OP94-80	65/80	Ø225 - 17	290,75
OP94-150	100/150	Ø260 - 19	285,75
OP94-200	200	Ø380 - 24	425,50
OP94-250	250	Ø500 - 27	982,50
OP94-300	300	Ø600 - 27	1162,00
OP94-500	350/500	Ø800 - 32	1435,25

SPILDEVAND: SPADEVENTILER



PN10-16



Max. 60°C



Flanger iht. DIN EN1092-2



Spadeventiler kan være mange ting og fås derfor i mange kombinationer. Åben eller lukket model. Uni- eller bi-directional. Wafer eller Lug type.

Spadeventil Mono DUKTILJERN



Letgående, lukket spadeventil af wafer-type i duktilt støbejern **til spildevand**. Tryktrin PN10.
Med håndhjul og rensepropper.

Spindel/spade = AISI 316, tætning = NBR			
Varenr.	DN	Byg L	DKK
OP200-50-NH	50	43	7959,00
OP200-65-NH	65	46	8621,25
OP200-80-NH	80	64	8760,25
OP200-100-NH	100	64	11901,75
OP200-125-NH	125	70	12875,00
OP200-150-NH	150	56	12236,50
OP200-200-NH	200	60	13570,25
OP200-250-NH	250	68	26280,50
OP200-300-NH	300	78	31816,75
OP200-400-NH	400	102	60404,50
OP200-500-NH	500	127	87035,00
OP200-600-NH	600	154	242858,75

Spadeventil Mono ISO top DUKTILJERN



Letgående, lukket spadeventil af wafer-type i duktilt støbejern **til spildevand**. Tryktrin PN10.
Med ISO top og rensepropper.

Spindel/spade = AISI 316, tætning = NBR			
Varenr.	DN	Byg L	DKK
OP202-50-N	50	43	7383,00
OP202-65-N	65	46	9409,25
OP202-80-N	80	64	8446,00
OP202-100-N	100	64	9883,00
OP202-125-N	125	70	13034,75
OP202-150-N	150	56	10717,25
OP202-200-N	200	60	12664,00
OP202-250-N	250	68	23010,25
OP202-300-N	300	78	28788,50
OP202-400-N	400	102	58645,00
OP202-500-N	500	127	84510,00
OP202-600-N	600	154	235785,00

Spadeventil Mono pneumatisk

DUKTILJERN



Letgående, lukket spadeventil af wafer-type i duktilt støbejern **til spildevand**. Tryktrin PN10.

Med pneumatisk aktuator og rensepropper.

Aktuatorens luftforbrug er 1/3 af normalt.

Spindel/spade = AISI 316, tætning = NBR

Varenr.	DN	Byg L	DKK
OP206-50	50	43	10248,50
OP206-65	65	46	10871,75
OP206-80	80	64	14734,25
OP206-100	100	64	16768,50
OP206-125	125	70	16670,75
OP206-150	150	56	18210,50
OP206-200	200	60	19003,50
OP206-250	250	68	28593,00
OP206-300	300	78	70333,75
OP206-400	400	102	130207,50
OP206-500	500	127	226100,50
OP206-600	600	154	295532,75

Montagekit til OP206

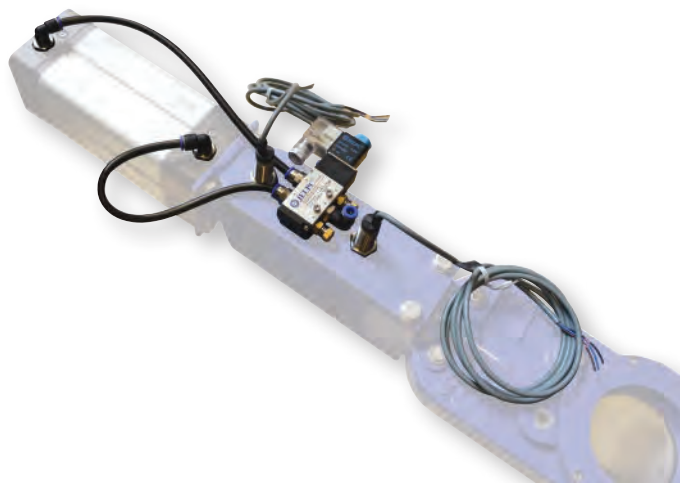

Består af magnetventil og induktive aftastere.

Varenr.	DN	Spænding	DKK
OP206-50-24	50	24 volt DC	2440,25
OP206-65-24	65	24 volt DC	2440,25
OP206-80-24	80	24 volt DC	2440,25
OP206-100-24	100	24 volt DC	2440,25
OP206-125-24	125	24 volt DC	2440,25
OP206-150-24	150	24 volt DC	2452,50
OP206-200-24	200	24 volt DC	2452,50
OP206-250-24	250	24 volt DC	2452,50
OP206-300-24	300	24 volt DC	2452,50
OP206-400-24	400	24 volt DC	2506,00
OP206-500-24	500	24 volt DC	2506,00
OP206-600-24	600	24 volt DC	2506,00
OP206-50-230	50	230 volt AC	2440,25
OP206-65-230	65	230 volt AC	2440,25
OP206-80-230	80	230 volt AC	2440,25
OP206-100-230	100	230 volt AC	2440,25
OP206-125-230	125	230 volt AC	2440,25
OP206-150-230	150	230 volt AC	2452,50
OP206-200-230	200	230 volt AC	2452,50
OP206-250-230	250	230 volt AC	2452,50
OP206-300-230	300	230 volt AC	2452,50
OP206-400-230	400	230 volt AC	2506,00
OP206-500-230	500	230 volt AC	2506,00
OP206-600-230	600	230 volt AC	2506,00

Spadeventil Mono V-port

DUKTILJERN



Letgående, lukket spadeventil af wafer-type i duktilt støbejern **til spildevand**. Tryktrin PN10. Med håndhjul og rensepropper. V-port til præcis regulering.

Spindel/spade = AISI 316, tætning = NBR

Varenr.	DN	Byg L	DKK
OP204-50-NH	50	43	8878,75
OP204-65-NH	65	46	9476,00
OP204-80-NH	80	64	10634,75
OP204-100-NH	100	64	12210,75
OP204-125-NH	125	70	13580,75
OP204-150-NH	150	56	15409,00
OP204-200-NH	200	60	18478,25
OP204-250-NH	250	68	30539,50
OP204-300-NH	300	78	38784,75
OP204-400-NH	400	102	71631,50
OP204-500-NH	500	127	103808,75
OP204-600-NH	600	154	263010,50

Spadeventil Mono m. hurtigluk

DUKTILJERN



Letgående, lukket spadeventil af wafer-type i duktilt støbejern **til spildevand**. Tryktrin PN10. Med hurtigluk og rensepropper.

Spindel/spade = AISI 316, tætning = NBR

Varenr.	DN	Byg L	DKK
OP208-50	50	43	8441,00
OP208-65	65	46	8959,00
OP208-80	80	64	9872,75
OP208-100	100	64	6428,25
OP208-125	125	70	12942,00
OP208-150	150	56	14394,25
OP208-200	200	60	16567,75
OP208-250	250	68	27357,00
OP208-300	300	78	34963,50
OP208-400	400	102	33546,25
OP208-500	500	127	α

α = spørg på pris

Spadeventil DUKTILJERN



Spadeventil af wafer-type i duktilt støbejern til spildevand. Tryktrin PN10.
Med håndhjul.

Spindel/spade = AISI 316, tætning = NBR

Varenr.	DN	Byg L	DKK
OP250-50	50	43	5664,00
OP250-65	65	46	5929,25
OP250-80	80	46	6673,00
OP250-100	100	52	6851,25
OP250-125	125	56	7727,25
OP250-150	150	56	9571,50
OP250-200	200	60	11636,50
OP250-250	250	68	15017,50
OP250-300	300	78	20635,75
OP250-350	350	78	28627,00
OP250-400	400	90	34334,75
OP250-450	450	90	60284,50
OP250-500	500	95	64193,75
OP250-600	600	105	92995,75

Passtykke DUKTILJERN



Passtykke til opnåelse af F4 byggemål ved udskiftning af skydeventil med spadeventil.

Varenr.	DN	Byg L	DKK
OP290-80	80	106	1589,50
OP290-100	100	116	1378,25
OP290-125	125	120	4742,25
OP290-150	150	144	836,75
OP290-200	200	160	1145,50
OP290-250	250	170	2726,50
OP290-300	300	180	3722,50
OP290-400	400	191	3630,75
OP290-500	500	206	28979,25
OP290-600	600	-	32939,50

Passtykke

AISI 316 / ALUMINIUM



Passtykke til opnåelse af F4 byggemål ved udskiftning af skydeventil med spadeventil.

AISI 316 rør m. ALU flanger

Varenr.	DN	Byg L	DKK
OP292-80	80	106	4987,00
OP292-100	100	116	5747,75
OP292-125	125	120	6941,25
OP292-150	150	144	8716,00
OP292-200	200	160	12556,25
OP292-250	250	170	14703,50
OP292-300	300	180	28861,00
OP292-400	400	191	32624,75
OP292-500	500	206	¤
OP292-600	600	-	¤

¤ = spørg på pris

SPILDEVAND: KONTRAVENTILER



PN10-16



Max. 70°C



Flanger iht. DIN EN1092-2



Kuglekontraventiler med flanger kan være udstyret med en drænventil. Derved slipper man for unødigt rengøring og kan nemt lufte trykket ud.

Kontraktlapventilerne har al indmaden i låget og er med 2 akselender, så man kan placere arm og lod i den side, man ønsker.

Alle malede ventiler er coatet med RAL5005 epoxy belægning min. 250micron (korrosionsklasse 4).

Kuglekontraventil m. dræn

DUKTILJERN / KUGLE = NBR



Kuglekontraventil i duktilt støbejern **til spildevand** i F6 byggemål med DIN PN10 flanger. Topdæksel med bajonetfatning. 1/2" drænventil.

Varenr.	DN	Byg L	DKK
OP100-40	40	180	1044,50
OP100-50	50	200	1044,50
OP100-65	65	235	1130,00
OP100-80	80	260	1395,75
OP100-100	100	300	1994,25
OP100-125	125	350	2924,25
OP100-150	150	400	3722,50
OP100-200	200	500	6656,00
OP100-250	250	600	13158,25
OP100-300	300	700	19472,25
OP100-350	350	800	27913,00
OP100-400	400	900	35210,75

Kuglekontraventil m. dræn

DUKTILJERN / KUGLE = NBR



Kuglekontraventil i duktilt støbejern **til spildevand** i F6 byggemål, med PN10 flanger. Forberedt for kugleudtag med nøgle.

Varenr.	DN	Byg L	DKK
OP110-40	40	180	1531,75
OP110-50	50	200	1492,50
OP110-65	65	230	1944,75
OP110-80	80	260	2336,25
OP110-100	100	300	3313,75
OP110-125	125	350	4891,50
OP110-150	150	400	6226,50
OP110-200	200	500	9919,00
OP110-250	250	600	22016,25
OP110-300	300	700	28799,00
OP110-350	350	800	44470,25
OP110-400	400	900	75257,00

Kuglekontraventil m. dræn

DUKTILJERN / KUGLE = NBR



Kuglekontraventil i duktilt støbejern **til spildevand** med gevindender.

Varenr.	BSPP	Byg L	DKK
OP120-7	1 1/4"	140	661,50
OP120-8	1 1/2"	150	661,50
OP120-9	2"	180	926,25

Kuglekontraventil

DUKTILJERN / KUGLE = NBR



Kuglekontraventil i duktilt støbejern **til spildevand**. Uden drænventil, med gevindender.

Varenr.	BSPP	Byg L	DKK
OP121-5	3/4"	-	339,75
OP121-6	1"	-	540,75
OP121-7	1 1/4"	140	580,75
OP121-8	1 1/2"	150	645,50
OP121-9	2"	180	918,00
OP121-10	2 1/2"	-	1548,50
OP121-11	3"	-	2160,50

Nøgle til kuglekontraventil



Varenr.	DN	DKK
OP190-50	50	1431,75
OP190-65	65	1789,25
OP190-80	80	2147,75
OP190-100	100	2923,25
OP190-125	125	2506,00
OP190-150	150	2761,50
OP190-200	200	3132,25
OP190-250	250	5011,00
OP190-300	300	6516,00
OP190-400	400	14315,00

Til OP110-XX

Kugle til kuglekontraventil



Varenr.	DN	dia	Vægt	DKK
OP192-25	25			134,75
OP192-32	32	40		134,75
OP192-40	40	48		185,75
OP192-50	50	60	0,45	268,75
OP192-65	65	80	0,5	371,75
OP192-80	80	95	1,2	402,75
OP192-100	100	120	1,7	615,75
OP192-125	125	150	3,2	1129,00
OP192-150	150	180	5,7	1353,50
OP192-200	200	248	8,5	2386,75
OP192-250	250	320	18,75	2804,75
OP192-300	300	365	29,25	4673,25
OP192-400	400		75	11843,00

Kugle til kuglekontraventil



Varenr.	DN	dia	Vægt	DKK
OP191-40	40	50	0,1	417,25
OP191-50	50	65	0,3	597,50
OP191-65	65	80	0,4	618,00
OP191-80	80	100	0,7	¤
OP191-100	100	120	1,1	¤
OP191-125	125	146	2,7	¤
OP191-150	150	173	4,2	¤
OP191-200	200	238	10,6	¤
OP191-250	250	298	17,7	¤
OP191-300	300	358	30,7	¤
OP191-400	400	478	78	¤

¤ = spørg på pris

Kugle til kuglekontraventil



"Flyde"				
Varenr.	Str.	dia	Vægt	DKK
OP194-32	32	40		UDGÅET
OP194-40	40	48	0,08	861,25
OP194-50	50	60	0,15	¤
OP194-65	65/80	95	0,39	860,25
OP194-100	100	120	0,79	¤
OP194-125	125/150	175	2,5	¤
OP194-200	200	240	6,1	¤
OP194-250	250	300	12	¤
OP194-300	300	360	19,3	¤

¤ = spørg på pris

Vinkelkuglekontraventil 90°

DUKTILJERN / KUGLE = NBR



90° kuglekontraventil i duktilt støbejern **til spildevand**, med PN10 flanger.

Varenr.	DN	DKK
OP135-50	50	2465,50
OP135-80	80	3271,25
OP135-100	100	4200,50
OP135-150	150	9328,00
OP135-200	200	16284,50

Kombiventil 90° m. flanger

DUKTILJERN / KUGLE = NBR



90° to-i-en ventil (spade og kuglekontra) **til spildevand**, med PN10 flanger og håndhjul.
NBR belagt kugle.

Varenr.	DN	DKK
GG33-65	65	7967,50
GG33-80	80	7967,50
GG33-100	100	9096,25

Vinkelkuglekontraventil 90°

DUKTILJERN / KUGLE = NBR - BSPP



90° kuglekontraventil **til spildevand** med indvendige gevindender.

Varenr.	BSPP	DKK
GG30-7	1 1/4"	2535,00
GG30-8	1 1/2"	2900,00
GG30-9	2"	3541,25

Kuglekontraventil

AISI 316 / KUGLE = NBR



AISI 316 kuglekontraventil **til spildevand** i F6 byggemål med PN10 flanger.

Varenr.	DN	Byg L	DKK
OP140-50	50	200	5817,25
OP140-65	65	230	11740,25
OP140-80	80	260	13647,75
OP140-100	100	300	14239,25
OP140-125	125	350	25949,00
OP140-150	150	400	34598,50

Kuglekontraventil m. dræn

AISI 316 / KUGLE = NBR



AISI 316 kuglekontraventil **til spildevand** med mufte gevindender.

Varenr.	BSPP	DKK
OP144-8	1 1/2"	1116,00
OP144-9	2"	1265,00

Kontraklapventil m. arm og lod

DUKTILJERN



Kontraklapventil i duktilt støbejern **til spildevand** i F6 byggemål, med PN10 flanger.

Akselen er monteret i låget og loddet kan fæstnes på begge sider.

Klap og aksel = AISI 316			
Varenr.	DN	Byg L	DKK
OP130-50	50	200	3299,25
OP130-65	65	240	4369,50
OP130-80	80	260	4645,50
OP130-100	100	300	6247,00
OP130-125	125	350	9265,00
OP130-150	150	400	14899,00
OP130-200	200	500	22207,00
OP130-250	250	600	29597,25
OP130-300	300	700	39289,50
OP130-350	350	800	42173,50
OP130-400	400	900	53163,50
OP130-450	450	1000	76060,50
OP130-500	500	1100	106893,50
OP130-600	600	1300	191539,00

Kontraklapventil

DUKTILJERN / AKSEL = AISI 304

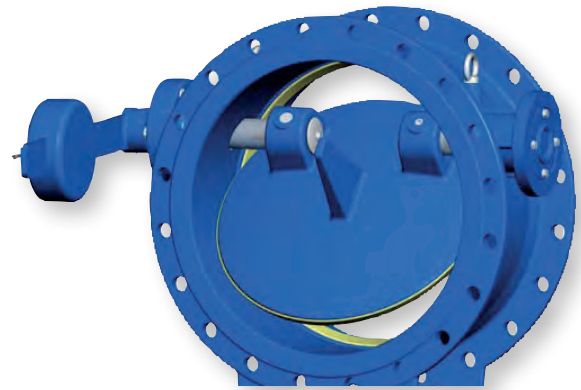

Kontraklapventil i duktilt støbejern **til vand og spildevand**, med PN10 flanger.

Varenr.	DN	Byg L	DKK
OP160-150	150	210	16299,75
OP160-200	200	230	18359,75
OP160-250	250	250	20687,75
OP160-300	270	270	25034,25
OP160-350	350	290	32331,75
OP160-400	400	310	40783,00
OP160-450	450	330	57875,75
OP160-500	500	350	68387,00
OP160-600	600	390	108654,75
OP160-700	700	430	174580,00
OP160-800	800	470	218767,00
OP160-900	900	510	300466,50
OP160-1000	1000	550	375857,50

Kontraklapventil

AISI 316



AISI 316 kontraklapventil **til spildevand** i F6 byggemål med PN10 flanger.

Varenr.	DN	Byg L	DKK
OP150-50	50	200	¤
OP150-65	65	240	¤
OP150-80	80	260	¤
OP150-100	100	300	¤
OP150-125	125	350	¤
OP150-150	150	400	¤

¤ = spørg på pris

Kontraklapventil

AISI 316 / FPM



AISI 316 kontraklapventil **til spildevand**. Meget kompakt model.

Varenr.	DN	DKK
OP152-32	32	691,00
OP152-40	40	782,00
OP152-50	50	1061,00
OP152-65	65	1278,25
OP152-80	80	1697,50
OP152-100	100	2393,00
OP152-125	125	2989,75
OP152-150	150	4015,75
OP152-200	200	6357,75

Bundventil m. flanger

DUKTILJERN / KLAP = AISI 316



Bundventil i duktilt støbejern med PN10 flanger.

Varenr.	DN	Byg L	DKK
OP170-40	40		1597,50
OP170-50	50	100	3240,50
OP170-65	65	120	1775,00
OP170-80	80	140	5490,00
OP170-100	100	170	4246,75
OP170-125	125	200	5881,50
OP170-150	150	230	5984,50
OP170-200	200	300	10735,50
OP170-250	250	370	16412,00

Bundventil muf/muf

DUKTILJERN / KLAP = AISI 316



Bundventil i duktilt støbejern med gevindender.

Varenr.	BSPP	Byg L	DKK
OP172-9	2"	140	1368,00
OP172-10	2 1/2"	167	1480,25
OP172-11	3"	177	1969,75
OP172-12	4"	208	2449,25

Bundventil m. bundsi

DUKTILJERN / KLAP + SI = AISI 316



Bundventil i duktilt støbejern med PN10 flanger. Filter påmonteret.

Varenr.	DN	L	DKK
OP170-40-B	40	180	2484,75
OP170-50-B	50	180	2377,75
OP170-65-B	65	220	2838,75
OP170-80-B	80	260	3300,75
OP170-100-B	100	320	5639,75
OP170-125-B	125	375	6087,50
OP170-150-B	150	430	7827,50
OP170-200-B	200	550	13076,50
OP170-250-B	250	670	19553,50

Bundsi t. bundventil

GALVANISERET

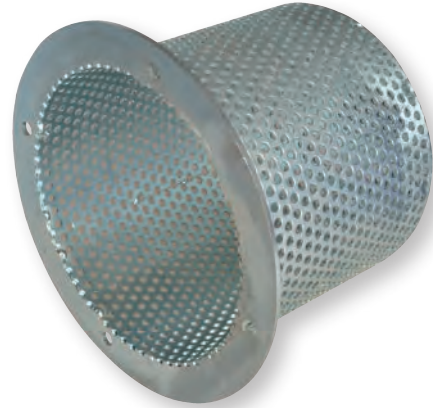

Varenr.	DN	Byg L	DKK
OP179-40	40	80	887,25
OP179-50	50	80	976,25
OP179-65	65	100	1065,00
OP179-80	80	120	1153,75
OP179-100	100	150	1423,00
OP179-125	125	175	1580,00
OP179-150	150	200	1832,00
OP179-200	200	250	2343,00
OP179-250	250	300	3140,75

Bundventil m. bundsi

DUKTILJERN / KLAP + SI = AISI 316



Bundventil i duktilt støbejern med indiv. gevindender og påmonteret bundsi.

Varenr.	BSPP	L	DKK
OP172-9-B	2"	225	1433,25
OP172-10-B	2 1/2"	252	1597,50
OP172-11-B	3"	282	2113,50
OP172-12-B	4"	326	2636,75

Filter

AISI 304 / PA (POLYAMID) - BSPT



Varenr.	Dim	DKK
E370-4	1/2"	25,60
E370-5	3/4"	29,25
E370-6	1"	31,30
E370-7	1 1/4"	28,35
E370-8	1 1/2"	34,15
E370-9	2"	45,90
E370-10	2 1/2"	101,25
E370-11	3"	126,50
E370-12	4"	200,50

KUGLEHANER RUSTFRI



Max. 63bar



-20°C til +180°C



Bredt program af kuglehaner, nogle også med aktuator.

Kuglehane 2-delt

AISI 316 - BSPP - FULD GENNEMLØB



Varenr.	BSPP	BAR	DKK
B33-2	1/4"	63	227,75
B33-3	3/8"	63	187,25
B33-4	1/2"	63	196,25
B33-5	3/4"	63	261,50
B33-6	1"	63	395,25
B33-7	1 1/4"	63	618,50
B33-8	1 1/2"	63	865,75
B33-9	2"	63	1152,75
B33-10	2 1/2"	40	2705,00
B33-11	3"	40	3883,25
B33-12	4"	25	7435,75

Kuglehane 2-delt låsbar

AISI 316 - BSPP - FULD GENNEMLØB



Varenr.	BSPP	DKK
B33-2-L	1/4"	227,75
B33-3-L	3/8"	187,25
B33-4-L	1/2"	196,25
B33-5-L	3/4"	261,50
B33-6-L	1"	395,25
B33-7-L	1 1/4"	618,50
B33-8-L	1 1/2"	865,75
B33-9-L	2"	1152,75
B33-10-L	2 1/2"	2705,00
B33-11-L	3"	3883,25

Kuglehane 3-delt

AISI 316 - BSPP - FULD GENNEMLØB



Varenr.	BSPP	BAR	DKK
B33-22	1/4"	63	432,25
B33-23	3/8"	63	432,25
B33-24	1/2"	63	432,25
B33-25	3/4"	63	560,25
B33-26	1"	63	731,25
B33-27	1 1/4"	63	1071,25
B33-28	1 1/2"	63	1398,75
B33-29	2"	63	2074,50
B33-30	2 1/2"	40	3577,25

Kuglehane 3-vejs L m. ISO top

AISI 316 - BSPP



Varenr.	BSPP	DKK
B33-42-ISO	1/4"	824,50
B33-43-ISO	3/8"	824,50
B33-44-ISO	1/2"	852,25
B33-45-ISO	3/4"	1169,25
B33-46-ISO	1"	1543,00
B33-47-ISO	1 1/4"	2200,25
B33-48-ISO	1 1/2"	2906,75
B33-49-ISO	2"	4276,75
B33-40-ISO	3"	¤

¤ = spørg på pris

Kuglehane 3-delt med ISO top

AISI 316 - BSPP - FULD GENNEMLØB



Varenr.	BSPP	Top	DKK
B33-22-ISO	1/4"	9	432,25
B33-23-ISO	3/8"	9	432,25
B33-24-ISO	1/2"	9	432,25
B33-25-ISO	3/4"	9	560,25
B33-26-ISO	1"	9	731,25
B33-27-ISO	1 1/4"	9	1071,25
B33-28-ISO	1 1/2"	14	1398,75
B33-29-ISO	2"	14	2074,50
B33-20-ISO	2 1/2"	14	3577,25
B33-21-ISO	3"	14	4084,00

Kuglehane 3-vejs T m. ISO top

AISI 316 - BSPP



Varenr.	BSPP	DKK
B33-52-ISO	1/4"	824,50
B33-53-ISO	3/8"	824,50
B33-54-ISO	1/2"	852,25
B33-55-ISO	3/4"	1169,25
B33-56-ISO	1"	1543,00
B33-57-ISO	1 1/4"	2200,25
B33-58-ISO	1 1/2"	2906,75
B33-59-ISO	2"	4276,75
B33-50-ISO	3"	¤

¤ = spørg på pris

Kuglehane 3-delt pneumatisk

AISI 316 - BSPP



Med pneumatisk aktuator.

Magnetventil medfølger ikke, skal bestilles separat.

Varenr.	BSPP	Motor	DKK
OP534-4	1/2"	HAT-50D	1779,00
OP534-5	3/4"	HAT-50D	1902,50
OP534-6	1"	HAT-63D	2320,75
OP534-7	1 1/4"	HAT-63D	2833,75
OP534-8	1 1/2"	HAT-75D	3766,75
OP534-9	2"	HAT-90D	5252,00
OP534-10	2 1/2"	HAT-90D	7779,75
OP534-11	3"	HAT-100D	10171,25

Kuglehane 3-vejs T pneumatisk

AISI 316 - BSPP



Med pneumatisk aktuator.

Magnetventil medfølger ikke, skal bestilles separat.

Varenr.	BSPP	DKK
OP524-4	1/2"	2178,50
OP524-5	3/4"	2347,50
OP524-6	1"	3073,75
OP524-7	1 1/4"	3161,25
OP524-8	1 1/2"	4395,25
OP524-9	2"	6808,50
OP524-10	2 1/2"	13421,00
OP524-11	3"	15584,00

Kuglehane 3-vejs L pneumatisk

AISI 316 - BSPP



Med pneumatisk aktuator.

Magnetventil medfølger ikke, skal bestilles separat.

Varenr.	BSPP	DKK
OP522-4	1/2"	2178,50
OP522-5	3/4"	2347,50
OP522-6	1"	3073,75
OP522-7	1 1/4"	3161,25
OP522-8	1 1/2"	4395,25
OP522-9	2"	6196,50
OP522-10	2 1/2"	13421,00
OP522-11	3"	15584,00

Kuglehane 3-delt 24V DC

AISI 316 - BSPP



Med elektrisk aktuator.

Varenr.	BSPP	Motor	DKK
OP530-4	1/2"	HL-05	3641,25
OP530-5	3/4"	HL-05	3805,00
OP530-6	1"	HL-05	4094,25
OP530-7	1 1/4"	HL-05	4274,50
OP530-8	1 1/2"	HL-05	5131,50
OP530-9	2"	HL-10	9280,50
OP530-10	2 1/2"	HL-10	11355,75
OP530-11	3"	HL-20	13400,50

Kuglehane 3-vejs T 24V DC

AISI 316 - BSPP



Med elektrisk aktuator.

Varenr.	BSPP	DKK
OP516-4	1/2"	3881,25
OP516-5	3/4"	4001,75
OP516-6	1"	4350,75
OP516-7	1 1/4"	5912,25
OP516-8	1 1/2"	6797,00
OP516-9	2"	7479,00
OP516-10	2 1/2"	14677,50
OP516-11	3"	16861,25

Kuglehane 3-vejs L 24V DC

AISI 316 - BSPP



Med elektrisk aktuator.

Varenr.	BSPP	DKK
OP514-4	1/2"	3881,25
OP514-5	3/4"	4001,75
OP514-6	1"	4350,75
OP514-7	1 1/4"	5912,25
OP514-8	1 1/2"	6797,00
OP514-9	2"	7479,00
OP514-10	2 1/2"	14677,50
OP514-11	3"	16861,25

Kuglehane 3-delt 230V AC

AISI 316 - BSPP



Med elektrisk aktuator.

Varenr.	BSPP	Motor	DKK
OP532-4	1/2"	HL-05S	3641,25
OP532-5	3/4"	HL-05S	3805,00
OP532-6	1"	HL-05S	4094,25
OP532-7	1 1/4"	HL-05S	4274,50
OP532-8	1 1/2"	HL-05S	5131,50
OP532-9	2"	HL-10S	9280,50
OP532-10	2 1/2"	HL-10S	11355,75
OP532-11	3"	HL-20S	13400,50

Kuglehane 3-vejs L 230V AC

AISI 316 - BSPP



Med elektrisk aktuator.

Varenr.	BSPP	DKK
OP518-4	1/2"	3881,25
OP518-5	3/4"	4001,75
OP518-6	1"	4350,75
OP518-7	1 1/4"	5912,25
OP518-8	1 1/2"	6797,00
OP518-9	2"	7479,00
OP518-10	2 1/2"	14677,50
OP518-11	3"	16861,25

Kuglehane 3-vejs T 230V AC

AISI 316 - BSPP



Med elektrisk aktuator.

Varenr.	BSPP	DKK
OP520-4	1/2"	3881,25
OP520-5	3/4"	4001,75
OP520-6	1"	4350,75
OP520-7	1 1/4"	5912,25
OP520-8	1 1/2"	6797,00
OP520-9	2"	7479,00
OP520-10	2 1/2"	14677,50
OP520-11	3"	16861,25

AKTUATORER OG TILBEHØR



Pneumatisk aktuator

BSP



Varenr.	Type	DKK
OP554-50D	HAT-50D	1269,00
OP554-63D	HAT-63D	1533,75
OP554-75D	HAT-75D	2031,25
OP554-90D	HAT-90D	2757,50
OP554-100D	HAT-100D	3248,75
OP554-125D	HAT-125D	4924,50
OP554-160D	HAT-160D	9409,25
OP554-190D	HAT-190D	14651,75
OP554-240D	HAT-240D	26636,00
OP554-63S	HAT-63S	1676,00
OP554-75S	HAT-75S	2898,50
OP554-90S	HAT-90S	3947,00

Elektrisk aktuator

BSP



Varenr.	Type	DKK
OP552-230-1	230VAC	∞
OP552-230-2	230VAC	4001,75
OP552-230-3	230VAC	4815,25
OP552-24-1	24VDC	∞
OP552-24-2	24VDC	4001,75
OP552-24-3	24VDC	5214,00

VAND & SPILDEVAND

Type 16: 5/2 EL Enkeltvirk.

Type 17: 5/2 EL Dobbeltvirk.

Type 21: 5/3 EL Dobbeltvirk. Luk type

Type 22: 5/3 EL Dobbeltvirk. Tryk type

Type 23: 5/3 EL Dobbeltvirk. Åben type

Spoleventil type Namur

ALUMINIUM - BSPP

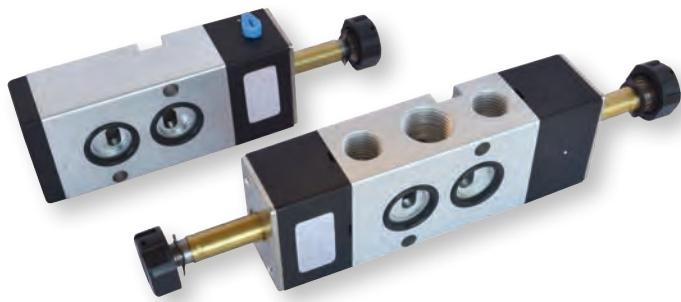

Varenr.	Port+Exh	Type	DKK
EV21-1	3 · 1/4"	16	402,00
EV21-2	1-3/8"+2-1/4"	16	402,00
EV21-3	3 · 1/4"	17	637,25
EV21-4	1-3/8"+2-1/4"	17	637,25
EV21-5	3 · 1/4"	21	1156,75
EV21-6	3 · 1/4"	23	1156,75
EV21-7	3 · 1/4"	22	1156,75
EV21-8	1-3/8"+2-1/4"	21	1156,75
EV21-9	1-3/8"+2-1/4"	23	1156,75
EV21-10	1-3/8"+2-1/4"	22	1156,75

Induktiv aftaster, elektrisk



Varenr.	Volt	DKK
OP570-230	230VAC	1099,75
OP570-24	24VDC	871,50

Tilbagemelder til luft, mekanisk



Mekanisk limit switch box til pneumatisk aktuator.

Varenr.	Type	DKK
OP572-1	-	544,00

Tilbagemelder til luft, induktiv

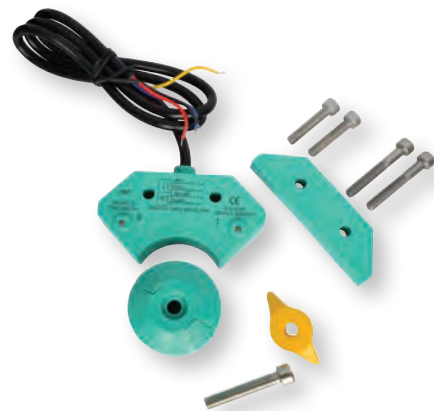

Induktiv aftaster til pneumatisk aktuator.

Varenr.	Type	DKK
OP574-1	1	877,25

Type 1 = tilbagemelder, type 2 = beslag

Tilbagemelder 4-20mA



Tilbagemelder til pneumatisk aktuator.

Varenr.	Str.	DKK
OP576-1	-	7044,25

Tilbagemelder 4-20mA



Tilbagemelder til elektrisk aktuator.

Varenr.	Str.	DKK
OP578-1	-	2822,50

KOBLINGER TIL VAND OG SPILDEVAND



PN10-16



Max. 60°C



Flanger iht. DIN EN1092-2



Stort program af koblinger, til alle typer rør. Alle malede koblinger er malet med RAL5005 epoxy belægning min. 250micron (korrosionsklasse 4).

Rørkobling trækfast

DUKTILJERN



Rørkobling i duktilt støbejern til alle typer rør. Koblingen giver mulighed for op til 8° vinkling.

Varenr.	Ø	Byg L	DKK
OP600-52	39-52	145	1367,00
OP600-64	49-64	145	1745,00
OP600-83	63-83	170	1916,00
OP600-93	72-93	170	2022,00
OP600-103	78-103	170	2027,25
OP600-117	87-117	170	2342,25
OP600-130	100-130	180	2658,50
OP600-147	117-147	180	3194,25
OP600-168	138-168	180	3826,50
OP600-182	152-182	215	4679,50
OP600-202	172-202	215	5530,25
OP600-228	198-228	215	6593,25
OP600-257	217-257	215	7443,00
OP600-285	245-285	300	9409,25
OP600-340	300-340	300	10753,25
OP600-380	340-380	300	9857,25
OP600-430	390-430	300	13822,75

Flangeadapter trækfast

DUKTILJERN



Flangeadapter i duktilt støbejern til alle typer rør. Koblingen giver mulighed for i alt 4° vinkling.

Varenr.	DN / Ø mm	Byg L	DKK
OP610-52	50 / 39-52	75	1338,00
OP610-64	50 / 49-64	75	1666,75
OP610-83	65 / 63-83	85	1687,25
OP610-103	80 / 78-103	85	1896,25
OP610-117	80-100 / 87-117	85	2003,50
OP610-130	100 / 100-130	90	2325,75
OP610-147	125 / 117-147	90	2509,25
OP610-182	150 / 152-182	110	3581,50
OP610-228	200 / 198-228	110	4529,00
OP610-285	250 / 245-285	150	5153,25
OP610-340	300 / 300-340	150	6949,50
OP610-380	350 / 345-385	150	9269,00
OP610-430	400 / 390-430	175	12684,50

Kombiflange trækfast

DUKTILJERN



Duktilt støbejerns kombiflange, der er trækfast for PE/PVC.

Varenr.	DN - Ø	Byg L	DKK
OP620-63	50-63	53	429,00
OP620-65	65-63	53	488,00
OP620-75	65-75	57	556,75
OP620-90	80-90	61	625,00
OP620-100	100-90	61	714,25
OP620-110	100-110	67	682,75
OP620-125	125-125	70	924,75
OP620-140	125-140	70	978,25
OP620-160	150-160	79	1275,25
OP620-200	200-200	91	1643,00
OP620-225	200-225	91	2931,50
OP620-250	250-250	106	3755,50
OP620-280	250-280	106	4336,25
OP620-315	300-315	110	5235,50
OP620-400	400-400	133	9151,75
OP620-500	500-500	150	14049,25

Rørkobling IKKE trækfast

DUKTILJERN



Rørkobling i duktilt støbejern til alle typer rør.

Varenr.	Ø	Byg L	DKK
OP630-55	25-55	110	735,00
OP630-69	39-69	110	755,75
OP630-76	46-76	110	766,75
OP630-78	48-78	110	778,50
OP630-87	57-87	110	788,25
OP630-108	78-108	110	844,25
OP630-117	87-117	110	882,25
OP630-130	100-130	110	1023,25
OP630-147	117-147	120	1133,00
OP630-159	129-159	120	1141,25
OP630-168	138-168	120	1201,00
OP630-182	152-182	120	1234,00
OP630-216	186-216	120	1839,75
OP630-228	198-228	120	2150,75
OP630-280	245-280	130	2833,75
OP630-332	297-332	150	3221,00
OP630-349	314-349	150	3297,25
OP630-378	343-378	150	3864,75
OP630-410	375-410	150	4187,00
OP630-431	396-431	200	4820,50
OP630-455	420-455	200	4863,75
OP630-532	497-532	200	5682,75
OP630-745	710-745	200	13647,50
OP630-975	934-975	250	25559,50

Flangeadapter IKKE trækfast DUKTILJERN



Flangeadapter i duktilt støbejern til alle typer rør.

Varenr.	DN / Ø mm	Byg L	DKK
OP640-55	40 / 25-55	65	778,50
OP640-87	65 / 57-87	65	825,00
OP640-108	80 / 78-108	65	903,75
OP640-117	80-100 / 87-117	65	953,50
OP640-130	100 / 100-130	65	984,00
OP640-147	125 / 117-147	70	1156,75
OP640-159	125-150 / 129-159	70	1281,50
OP640-182	150 / 152-182	75	1375,25
OP640-216	200 / 186-216	75	2018,00
OP640-228	200 / 198-228	75	2178,50
OP640-280	250 / 245-280	85	2942,75
OP640-301	250 / 266-301	90	3139,50
OP640-349	300 / 314-349	90	3349,75
OP640-378	350 / 343-378	90	4516,75
OP640-431	396-431	127	5901,00
OP640-455	400 / 420-455	127	6294,50
OP640-492	450 / 457-492	127	7277,00
OP640-532	497-532	127	9244,25
OP640-568	533-568	127	10325,75
OP640-660	625-660	130	12976,00

Kombiflange IKKE trækfast DUKTILJERN



Kombiflange i duktilt støbejern for PE/PVC.

Varenr.	DN - Ø	Byg L	DKK
OP660-63	50-63	48	256,00
OP660-65	65-63	48	281,25
OP660-75	65-75	54	280,50
OP660-90	80-90	56	364,00
OP660-100	100-90	56	377,00
OP660-110	100-110	62	403,75
OP660-125	125-125	66	476,75
OP660-140	125-140	66	512,75
OP660-160	150-160	73	720,00
OP660-200	200-200	84	842,75
OP660-225	200-225	84	1220,75
OP660-250	250-250	101	1220,75
OP660-280	250-280	101	1953,00
OP660-315	300-315	111	2931,50
OP660-400	400-400	133	6163,75
OP660-500	500-500	128	9522,50

Rørkobling lang IKKE trækfast DUKTILJERN



Rørkobling i duktilt støbejern til alle typer rør.

Varenr.	Ø	Byg L	DKK
OP650-168	138-168	756	14821,75
OP650-202	172-202	756	16583,00
OP650-280	245-280	806	24493,50
OP650-332	297-332	856	27315,75
OP650-349	314-349	856	29597,25
OP650-378	343-378	856	33552,25
OP650-660	625-660	916	69267,50

Støttebøsning

AISI 316



Støttebøsning i AISI 316 stål til SDR17 rør.

Kan leveres til andre SDR typer.

Varenr.	Ø	DKK
OP690-90	90	436,75
OP690-110	110	458,75
OP690-125	125	524,25
OP690-140	140	665,00
OP690-160	160	688,00
OP690-200	200	1201,00
OP690-225	225	1462,75
OP690-250	250	1528,75
OP690-315	315	2132,25

Dismantling Joint

DUKTILJERN



Varenr.	DN	L max	DKK
OP692-40	40	205	2485,75
OP692-50	50	205	2633,75
OP692-65	65	205	2827,50
OP692-80	80	225	3240,75
OP692-100	100	225	3502,75
OP692-125	125	225	4367,75
OP692-150	150	225	5141,00
OP692-200	200	245	6584,25
OP692-250	250	245	8731,25
OP692-300	300	245	9629,00
OP692-350	350	255	12536,00
OP692-400	400	255	15182,75
OP692-500	500	275	19966,50
OP692-600	600	285	27479,00
OP692-700	700	285	33945,75
OP692-800	800	315	40621,50
OP692-900	900	350	50036,25
OP692-1000	1000	360	55029,00
OP692-1200	1200	450	98119,00

KOBLINGER RUSTFRI TIL VA



PN10-16



EPDM: -40°C +100°C, NBR: -20°C +80°C
HNBR: -20°C +150°C, Viton: -20°C +250°C



- Rustfrie koblinger kan typisk leveres i både AISI 316 og AISI 304 udgaver.
- Trækfaste koblinger har gribekranse af AISI 316.
- Specialstørrelser kan laves på forespørgsel.
- Brandsikre udgaver fås også på forespørgsel.
- Endelig kan pakningerne fås i andre materialer end EPDM, f.eks. NBR, VITON, HNBR og silicone.

Rørkobling trækfast

AISI 316 / EPDM



Fuldsvejst rørkobling.

Tætning = EPDM				
Varenr.	Ø	DKK		
OP720-34-E	33,4-34,0	702,25	OP720-140-E	138,7-141,7 2124,00
OP720-42-E	41,4-43,4	769,00	OP720-154-E	153,0-156,0 2397,00
OP720-48-E	47,3-49,3	782,00	OP720-156-E	155,0-158,0 2432,00
OP720-51-E	50,0-52,0	846,25	OP720-168-E	167,3-170,3 2440,25
OP720-60-E	59,3-62,3	928,25	OP720-204-E	203,0-206,0 4737,00
OP720-63-E	62,0-65,0	1105,25	OP720-219-E	218,1-221,1 4875,00
OP720-69-E	68,0-71,0	1105,25	OP720-254-E	253,0-256,0 6406,75
OP720-76-E	75,1-78,1	1044,50	OP720-273-E	272,0-275,0 7156,50
OP720-84-E	83,0-86,0	1097,00	OP720-304-E	303,0-306,0 7022,75
OP720-89-E	87,9-90,9	1097,00	OP720-324-E	322,9-325,9 7540,75
OP720-104-E	103,0-106,0	1255,75	OP720-354-E	353,0-356,0 7156,50
OP720-108-E	107,0-110,0	1393,75	OP720-356-E	354,6-357,6 8101,00
OP720-114-E	113,3-116,3	1334,00	OP720-406-E	405,4-408,4 8384,25
OP720-129-E	128,0-131,0	1998,25	OP720-456-E	455,0-458,0 8456,50
			OP720-506-E	505,0-508,0 10593,75
			OP720-606-E	605,0-608,0 11113,75

Rørkobling trækfast

AISI 304 / EPDM



Rørkobling IKKE trækfast

AISI 316 / EPDM



Fuldsvejst rørkobling.

Varenr.	∅	DKK
OP721-38-E	37,0-39,0	678,00
OP721-42-E	41,4-43,4	678,00
OP721-48-E	47,3-49,3	790,75
OP721-76-E	75,1-78,1	940,25
OP721-84-E	83,0-86,0	1002,25
OP721-89-E	87,9-90,9	1017,75
OP721-104-E	103,0-106,0	1110,50
OP721-108-E	107,0-110,0	1125,00
OP721-114-E	113,3-116,3	1141,25
OP721-129-E	128,0-131,0	1542,00
OP721-140-E	138,7-141,7	1633,75
OP721-154-E	153,0-156,0	2300,00
OP721-168-E	167,3-170,3	2066,25
OP721-204-E	203,0-206,0	4379,75
OP721-219-E	218,1-221,1	4547,50
OP721-254-E	253,0-256,0	5474,50
OP721-273-E	272,0-275,0	5559,00
OP721-304-E	303,0-306,0	6637,50
OP721-324-E	322,9-325,9	6401,50
OP721-406-E	405,4-408,4	8590,25
OP721-506-E	505,0-508,0	10423,75
OP721-600-E	605,0-608,0	10609,00

Fuldsvejst rørkobling.

Varenr.	∅	DKK
OP730-34-E	33,4-34,0	847,25
OP730-42-E	41,4-43,4	916,00
OP730-48-E	46,8-49,8	932,50
OP730-60-E	58,8-61,8	966,25
OP730-69-E	67,5-70,5	1075,50
OP730-76-E	74,6-77,6	1023,25
OP730-84-E	82,0-86,0	1016,50
OP730-89-E	86,9-90,9	1067,25
OP730-104-E	102,0-106,0	1206,25
OP730-110-E	108,0-112,0	1165,00
OP730-114-E	112,3-116,3	1128,00
OP730-129-E	127,0-131,0	1482,25
OP730-140-E	137,7-141,7	1485,50
OP730-154-E	151,5-156,5	1576,00
OP730-160-E	157,5-162,5	1576,00
OP730-168-E	165,8-170,8	1521,50
OP730-204-E	201,0-207,0	2834,75
OP730-219-E	216,1-222,1	2762,50
OP730-254-E	251,0-257,0	3318,75
OP730-273-E	270,0-276,0	3259,00
OP730-304-E	301,0-307,0	3470,25
OP730-315-E	312,0-318,0	□
OP730-324-E	320,9-326,9	3508,25
OP730-355-E	352,6-358,6	8327,75
OP730-356-E	353,0-359,0	6135,75
OP730-406-E	403,0-409,0	4724,75
OP730-456-E	453,0-459,0	6092,50
OP730-500-E	497,0-503,0	6415,00
OP730-506-E	503,0-509,0	6415,00
OP730-508-E	505,0-511,0	6415,00
OP730-606-E	603,0-609,0	7239,00
OP730-706-E	702,0-710,0	8008,25

Rørkobling IKKE trækfast

AISI 316 / AISI 304 / EPDM



Fuldsvejst rørkobling.

Hus = AISI 316, beslag = AISI 304, tætning = EPDM

Varenr.	∅	DKK
OP731-38	37,0-39,0	824,50
OP731-42	41,4-43,4	824,50
OP731-48	46,8-49,8	843,00
OP731-70	68,5-71,5	914,00
OP731-76	74,6-77,6	914,00
OP731-84	82,0-86,0	914,00
OP731-89	86,9-90,9	950,00
OP731-104	102,0-106,0	1020,75
OP731-108	106,0-110,0	1020,75
OP731-114	112,3-116,3	1020,75
OP731-129	127,0-131,0	1362,75
OP731-154	151,5-156,5	1434,00
OP731-204	201,0-207,0	2544,25
OP731-254	251,0-257,0	2833,75
OP731-256	253,0-259,0	2833,75
OP731-304	301,0-307,0	3117,00
OP731-315	312,0-318,0	3117,00
OP731-356	352,6-358,6	4034,75
OP731-370	367,0-373,0	4034,75
OP731-406	403,4-409,4	4181,00
OP731-450	447,0-453,0	5366,50
OP731-506	503,0-509,0	5464,25
OP731-600	597,0-603,0	6111,00
OP731-606	603,0-609,0	6111,00

Reparationskobling

AISI 316 / EPDM



Fuldsvejst reparationskobling.

Varenr.	∅	L	DKK
OP700-48-E	46,8-49,8	85	1785,00
OP700-70-E	68,5-71,5	85	2014,75
OP700-76-E	74,6-77,6	110	2522,50
OP700-84-E	82,0-86,0	110	2522,50
OP700-89-E	86,9-90,9	110	2871,75
OP700-104-E	102,0-106,0	110	3161,25
OP700-108-E	106,0-110,0	110	3161,25
OP700-114-E	112,3-116,3	110	2999,50
OP700-129-E	127,0-131,0	110	3292,00
OP700-140-E	137,7-141,7	110	3292,00
OP700-154-E	151,5-156,5	110	3292,00
OP700-160-E	157,5-162,5	110	3389,75
OP700-168-E	165,8-170,8	110	3209,50
OP700-204-E	201,0-207,0	110	4995,50
OP700-219-E	216,1-222,1	110	4733,00
OP700-254-E	251,0-257,0	110	5290,25
OP700-256-E	253,0-259,0	110	5290,25
OP700-273-E	270,0-276,0	110	5290,25
OP700-304-E	301,0-307,0	110	5666,25
OP700-315-E	312,0-318,0	110	5666,25
OP700-356-E	352,6-358,6	140	8368,75
OP700-370-E	373,0-377,0	140	8368,75
OP700-406-E	403,4-409,4	140	9156,75
OP700-506-E	503,0-509,0	140	10531,75
OP700-606-E	603,0-609,0	140	12282,75

ANBORINGER



Anboringer til PVC/PE rør. Alle malede anboringer er coatet med RAL5005 epoxy belægning min. 250micron (korrosionsklasse 4).

Saddel-T DUKTILJERN - BSPP



Anboring i duktilt støbejern til PE/PVC.

Varenr.	Ø × BSPP × Ø	DKK			
OP800-50-6	50 × 1" × 50	284,25	OP800-140-9	140 × 2" × 140	819,00
OP800-63-6	63 × 1" × 63	336,00	OP800-160-6	160 × 1" × 160	859,75
OP800-75-6	75 × 1" × 75	371,50	OP800-160-7	160 × 1¼" × 160	841,00
OP800-75-7	75 × 1¼" × 75	375,00	OP800-160-8	160 × 1½" × 160	841,00
OP800-75-9	75 × 2" × 75	359,50	OP800-160-9	160 × 2" × 160	799,75
OP800-90-6	90 × 1" × 90	442,75	OP800-200-6	200 × 1" × 200	1217,50
OP800-90-7	90 × 1¼" × 90	430,50	OP800-200-7	200 × 1¼" × 200	1217,50
OP800-90-9	90 × 2" × 90	442,75	OP800-200-8	200 × 1½" × 200	1217,50
OP800-110-6	110 × 1" × 110	531,25	OP800-200-9	200 × 2" × 200	1217,50
OP800-110-7	110 × 1¼" × 110	538,25	OP800-225-6	225 × 1" × 225	1360,75
OP800-110-8	110 × 1½" × 110	531,25	OP800-225-9	225 × 2" × 225	1338,00
OP800-110-9	110 × 2" × 110	531,25	OP800-250-6	250 × 1" × 250	1388,50
OP800-125-6	125 × 1" × 125	856,00	OP800-250-9	250 × 2" × 250	1386,50
OP800-125-7	125 × 1¼" × 125	819,00	OP800-280-6	280 × 1" × 280	1622,25
OP800-125-8	125 × 1½" × 125	819,00	OP800-280-9	280 × 2" × 280	1549,25
OP800-125-9	125 × 2" × 125	819,00	OP800-315-6	315 × 1" × 315	1527,50
OP800-140-6	140 × 1" × 140	819,00	OP800-315-9	315 × 2" × 315	1525,50
OP800-140-7	140 × 1¼" × 140	819,00	OP800-400-6	400 × 1" × 400	1735,75
OP800-140-8	140 × 1½" × 140	819,00	OP800-400-9	400 × 2" × 400	1735,75

Adapter til sadel T

DUKTILJERN - BSPP



Varenr.	Udvaldv	DKK
OP810-9-6	2"×1"	706,00
OP810-9-8	2"×1 1/2"	732,00
OP810-9	2"×2"	821,25

Anboringsbøjle m. flange

DUKTILJERN



Anboringsbøjle i duktilt støbejern med flange til alle typer rør.

Varenr.	DN	Ø rør	DKK
OP860-80	80	150-400	1115,50
OP860-100	100	250-400	1220,75

Spade til anboringsadapter



Varenr.	Str.	DKK
OP820	-	274,00

Stålbånd t. bøjle

AISI 304 / EPDM



Varenr.	Ø rør	DKK
OP890-95	77-95	168,50
OP890-119	98-119	176,75
OP890-135	125-135	169,75
OP890-160	139-160	204,75
OP890-180	150-180	207,00
OP890-195	170-195	378,75
OP890-230	200-230	249,75
OP890-280	250-280	272,75
OP890-315	285-315	450,25
OP890-340	315-340	126,50

Anboringsbøjle m. muffe

DUKTILJERN - BSPP



Anboringsbøjle i duktilt støbejern med gevind til alle typer rør.

Varenr.	BSPP	Ø rør	DKK
OP850-6-200	1"	50-200	119,00
OP850-6-300	1"	100-300	256,50
OP850-7-200	1 1/4"	50-200	131,25
OP850-7-300	1 1/4"	100-300	176,00
OP850-8-200	1 1/2"	50-200	130,75
OP850-8-300	1 1/2"	100-300	212,25
OP850-9-300	2"	100-300	256,50

KOMPENSATORER



PN10-16



Max. 70°C



Absorberer svingninger og bevægelser forårsaget af pumper, kompressorer, armaturer osv.

Reducerer larm og udligner de spændinger (aksiale forskelle og forskelle på siderne), der kan opstå grundet unøjagtigheder i monteringen.

Gummi kompensator

EPDM / METAL = AISI 304



Varenr.	DN	Byg L	DKK
OP900-65	65	130mm	4290,75
OP900-80	80	130mm	5102,25
OP900-100	100	130mm	5250,00
OP900-125	125	130mm	6646,75
OP900-150	150	130mm	8276,25
OP900-200	200	130mm	10186,75
OP900-250	250	130mm	14636,50
OP900-300	300	130mm	19091,25

Gummi kompensator

NBR / METAL = AISI 304



Varenr.	DN	Byg L	DKK
OP901-65	65	130mm	4703,25
OP901-80	80	130mm	4529,00
OP901-100	100	130mm	4808,50
OP901-125	125	130mm	5852,50
OP901-150	150	130mm	8238,75
OP901-200	200	130mm	10088,00
OP901-250	250	130mm	12689,00
OP901-300	300	130mm	23327,50

Gummi kompensator

EPDM / METAL = STÅL



Varenr.	DN	Byg L	DKK
OP910-50	50	105mm	363,75
OP910-65	65	115mm	490,25
OP910-80	80	130mm	564,75
OP910-100	100	135mm	726,00
OP910-125	125	170mm	903,50
OP910-150	150	180mm	1258,75
OP910-200	200	205mm	1754,50
OP910-250	250	240mm	2655,50
OP910-300	300	260mm	5946,75
OP910-350	350	265mm	8872,00
OP910-400	400	265mm	10929,50
OP910-500	500	265mm	14795,25

Gummi kompensator

EPDM / METAL = STÅL

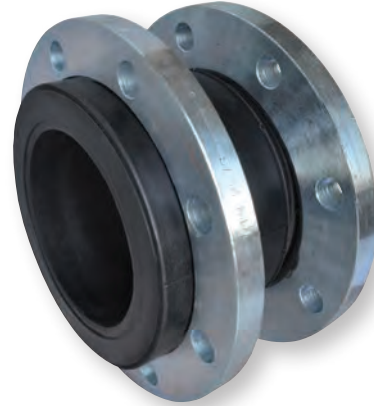

El-galvaniseret

Varenr.	DN	Byg L	DKK
OP920-50	50	130mm	1130,25
OP920-65	65	130mm	1292,50
OP920-80	80	130mm	1516,75
OP920-100	100	130mm	1871,75
OP920-125	125	130mm	2419,50
OP920-150	150	130mm	3097,75
OP920-200	200	130mm	4130,00
OP920-250	250	130mm	5401,00
OP920-300	300	130mm	6363,00
OP920-350	350	203mm	12796,00
OP920-400	400	203mm	13204,00
OP920-500	500	203mm	16355,75

Gummi kompensator

NBR / METAL = STÅL



El-galvaniseret

Varenr.	DN	Byg L	DKK
OP911-50	50	105mm	379,50
OP911-65	65	115mm	522,25
OP911-80	80	130mm	629,50
OP911-100	100	135mm	743,00
OP911-125	125	170mm	917,00
OP911-150	150	180mm	1265,00
OP911-200	200	205mm	1834,00
OP911-350	350	265mm	☐
OP911-400	400	265mm	☐
OP911-500	500	265mm	☐

Gummi kompensator

NBR / METAL = STÅL

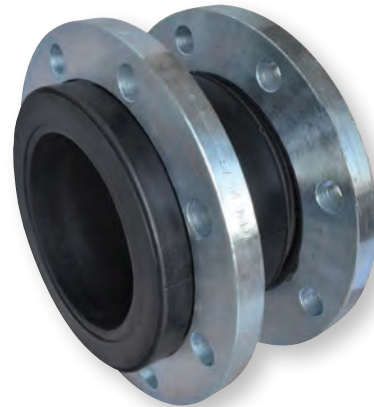

El-galvaniseret

Varenr.	DN	Byg L	DKK
OP921-50	50	130mm	1108,00
OP921-65	65	130mm	1960,50
OP921-80	80	130mm	1487,00
OP921-100	100	130mm	1870,75
OP921-125	125	130mm	2372,00
OP921-150	150	130mm	3097,75
OP921-200	200	130mm	4049,00
OP921-250	250	130mm	5295,00
OP921-300	300	130mm	6239,00

STØBEJERNSFITTINGS



PN10-16



Max. 70°C



Flanger iht. DIN EN1092-2



Bredt program af støbejernsfittings. Alle malede fittings er coated med RAL5005 epoxy belægning min. 250micron (korrosionsklasse 4).

Bøjning 90° m. 2-delte løslflanger

DUKTILJERN



DIN PN10/16 90° bøjning i duktilt støbejern.

Kan fås op til DN1000. Fra og med DN700 faste flanger.

Varenr.	DN	Byg L	DKK
OP1006-40	40	140	681,50
OP1006-50	50	150	681,50
OP1006-65	65	165	701,50
OP1006-80	80	165	838,50
OP1006-100	100	180	1048,75
OP1006-125	125	200	1257,75
OP1006-150	150	220	1887,00
OP1006-200	200	260	2619,50
OP1006-250	250	350	5239,75
OP1006-300	300	400	8069,25
OP1006-350	350	450	9074,50
OP1006-400	400	500	10521,50
OP1006-450	450	550	20914,25
OP1006-500	500	600	25853,00
OP1006-600	600	700	38316,00

Bøjning 45° m. 2-delte løslflanger

DUKTILJERN



DIN PN10/16 45° bøjning i duktilt støbejern.

Kan fås op til DN1000. Fra og med DN700 faste flanger.

Varenr.	DN	Byg L	DKK
OP1004-40	40	78	681,50
OP1004-50	50	85,5	681,50
OP1004-65	65	92	733,75
OP1004-80	80	130	838,50
OP1004-100	100	140	1168,25
OP1004-125	125	150	1257,75
OP1004-150	150	160	1887,00
OP1004-200	200	180	2619,50
OP1004-250	250	245	5029,50
OP1004-300	300	275	7345,00
OP1004-350	350	300	8405,00
OP1004-400	400	325	9841,75
OP1004-450	450	350	18648,25
OP1004-500	500	375	21455,00
OP1004-600	600	426	28314,75

Bøjning 22° m. 2-delte løsflanger DUKTILJERN



DIN PN10/16 22° bøjning i duktilt støbejern.

Kan fås op til DN1000. Fra og med DN700 faste flanger.

Varenr.	DN	Byg L	DKK
OP1002-40	40	65	629,75
OP1002-50	50	65	629,75
OP1002-65	65	65	682,00
OP1002-80	80	65	UDGÅET
OP1002-100	100	68	858,75
OP1002-125	125	75	1080,50
OP1002-150	150	80	1466,75
OP1002-200	200	87	UDGÅET
OP1002-250	250	110	3887,25
OP1002-300	300	123	6033,75
OP1002-350	350	140	7242,00
OP1002-400	400	150	8822,00
OP1002-450	450	170	13385,00
OP1002-500	500	180	16361,75
OP1002-600	600	205	28078,00

Bøjning 11° m. 2-delte løsflanger DUKTILJERN



DIN PN10/16 11° bøjning i duktilt støbejern.

Kan fås op til DN1000. Fra og med DN700 faste flanger.

Varenr.	DN	Byg L	DKK
OP1000-40	40	57	629,75
OP1000-50	50	57	629,75
OP1000-65	65	57	682,00
OP1000-80	80	57	720,50
OP1000-100	100	60	908,50
OP1000-125	125	63	1102,25
OP1000-150	150	68	1336,00
OP1000-200	200	71	1949,00
OP1000-250	250	84	4192,25
OP1000-300	300	95	6033,75
OP1000-350	350	110	7242,00
OP1000-400	400	120	8822,00
OP1000-450	450	125	9682,00
OP1000-500	500	130	12344,75
OP1000-600	600	150	27877,00

Fodbøjning 90° m. 2-delte løsflanger

DUKTILJERN



DIN PN10/16 90° fodbøjning i duktilt støbejern. Kan fås op til DN1000. Fra og med DN700 faste flanger.

Varenr.	DN	Byg L	DKK
OP1008-40	40	140	868,25
OP1008-50	50	150	868,25
OP1008-65	65	165	935,25
OP1008-80	80	165	1004,75
OP1008-100	100	180	1111,50
OP1008-125	125	200	1634,75
OP1008-150	150	220	2401,00
OP1008-200	200	260	3325,00
OP1008-250	250	350	6677,50
OP1008-300	300	400	10284,75
OP1008-350	350	450	11546,50
OP1008-400	400	500	13385,00
OP1008-500	500	600	32908,50
OP1008-600	600	700	48770,50

Reduktion m. 2-delte løsflanger

DUKTILJERN



DIN PN10/16 reduktion i duktilt støbejern med minimalt tryktab. Kan fås op til DN1000. Fra og med DN700 faste flanger.

Varenr.	DN	Byg L	DKK
OP1010-5040	50×40	150	509,25
OP1010-6540	65×40	190	550,75
OP1010-6550	65×50	190	550,75
OP1010-8040	80×40	185	665,25
OP1010-8050	80×50	185	665,25
OP1010-8065	80×65	190	665,25
OP1010-10040	100×40	195	892,00
OP1010-10050	100×50	195	892,00
OP1010-10065	100×65	195	892,00
OP1010-10080	100×80	200	892,00
OP1010-12540	125×40	185	1154,75
OP1010-12550	125×50	185	1154,75
OP1010-12565	125×65	185	1154,75
OP1010-12580	125×80	185	1103,25
OP1010-125100	125 × 100	185	1103,25
OP1010-15065	150 × 65	190	1362,75
OP1010-15080	150 × 80	190	1362,75
OP1010-150100	150 × 100	190	1362,75
OP1010-150125	150 × 125	190	1362,75
OP1010-200100	200 × 100	235	1854,00
OP1010-200125	200 × 125	235	1884,00
OP1010-200150	200 × 150	235	1894,25
OP1010-250100	250 × 100	250	2296,00
OP1010-250125	250 × 125	250	2410,25
OP1010-250150	250 × 150	250	2410,25
OP1010-250200	250 × 200	250	2277,50
OP1010-300150	300 × 150	265	3506,25
OP1010-300200	300 × 200	265	3668,00
OP1010-300250	300 × 250	265	3668,00
OP1010-350200	350 × 200	290	3673,00
OP1010-350250	350 × 250	290	4944,00
OP1010-350300	350 × 300	290	4944,00
OP1010-400300	400 × 300	300	8204,00
OP1010-400350	400 × 350	300	8204,00
OP1010-450400	450 × 400	300	11561,75
OP1010-500350	500 × 350	600	15146,25
OP1010-500400	500 × 400	600	15146,25
OP1010-600400	600 × 400	600	20100,50
OP1010-600500	600 × 500	600	20100,50

Reduktion excent. DUKTILJERN



Excentrisk reduktion i duktilt støbejern med minimalt tryktab.
Kan fås op til DN1000.

Varenr.	DN	DKK
OP1012-8050	80 × 50	724,00
OP1012-8065	80 × 65	863,00
OP1012-10050	100 × 50	886,00
OP1012-10080	100 × 80	932,25
OP1012-15080	150 × 80	1586,25
OP1012-150100	150 × 100	1911,75
OP1012-20080	200 × 80	2539,00
OP1012-200100	200 × 100	2677,00
OP1012-200150	200 × 150	1993,25
OP1012-250150	250 × 150	3769,00
OP1012-250200	250 × 200	2926,25
OP1012-300100	300 × 100	4165,50
OP1012-300150	300 × 150	4380,75
OP1012-300200	300 × 200	5057,50
OP1012-125100	350 × 250	3917,25
OP1012-350200	350 × 200	6788,75
OP1012-400250	400 × 250	8569,75
OP1012-400300	400 × 300	9347,25
OP1012-450300	450 × 300	10573,00
OP1012-450400	450 × 400	9795,50

Reduktion pindsvin DUKTILJERN



Faset reduktion for mindre tryktab.

Bolte og møtrikker = AISI 316

Varenr.	DN	Byg L	Bolte	DKK
OP1014-6550	65×50	-	4/4	1317,50
OP1014-8050	80 × 50	55	8/4	1384,50
OP1014-8065	80×65	55	8/4	1479,25
OP1014-10050	100×50	-	8/4	1629,50
OP1014-10065	100 × 65	-	8/4	1566,75
OP1014-10080	100 × 80	30	8/8	1599,75
OP1014-12580	125 × 80	-	8/8	1667,75
OP1014-125100	125 × 100	-	8/8	2159,00
OP1014-15080	150×80	30	8/8	2379,50
OP1014-150100	150×100	30	8/8	2084,75
OP1014-150125	150 × 125	-	8/8	2453,50
OP1014-200100	200×100	45	8/8	2279,50
OP1014-200150	200 × 150	35	8/8	3062,25
OP1014-250150	250×150	45	12/8	3248,75
OP1014-250200	250×200	45	12/8	3794,75
OP1014-300200	300×200	55	12/8	4023,25

Bolte = antal bolte på de 2 sider

Reduktion pindsvin DUKTILJERN

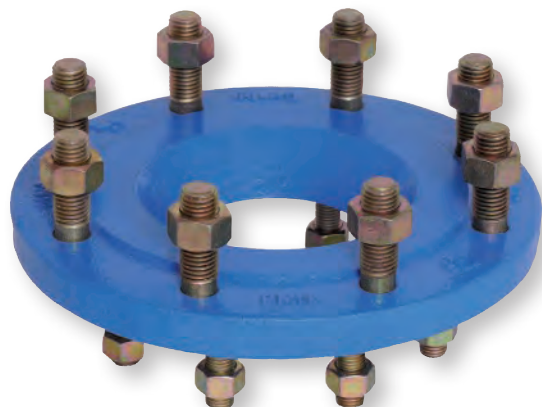

Faset reduktion for mindre tryktab.

Bolte og møtrikker = STÅL				
Varenr.	DN	Byg L	Bolte	DKK
OP1016-6550	65 × 50	-	4/4	880,00
OP1016-8050	80 × 50	55	8/4	1040,50
OP1016-8065	80 × 65	55	8/4	868,50
OP1016-10050	100 × 50	-	8/4	1108,50
OP1016-10065	100 × 65	-	8/4	993,75
OP1016-10080	100 × 80	30	8/8	884,75
OP1016-12580	125 × 80	-	8/8	897,25
OP1016-125100	125 × 100	-	8/8	1144,50
OP1016-15080	150 × 80	30	8/8	1384,50
OP1016-150100	150 × 100	30	8/8	1442,00
OP1016-150125	150 × 125	-	8/8	1743,00
OP1016-200100	200 × 100	45	8/8	1594,50
OP1016-200150	200 × 150	35	8/8	1896,25
OP1016-250150	250 × 150	45	12/8	2508,25
OP1016-250200	250 × 200	45	12/8	1578,00
OP1016-300200	300 × 200	55	12/8	1796,50
OP1016-300250	300 × 250	-	12/12	3004,75

Bolte = antal bolte på de 2 sider

Flangehale DUKTILJERN



Flangehale i duktilt støbejern med DIN PN10 flange.

Varenr.	DN	Byg L	Byg L1	DKK
OP1020-40	40	335	200	641,00
OP1020-50	50	340	200	752,00
OP1020-65	65	345	200	863,25
OP1020-80	80	350	215	924,75
OP1020-100	100	350	215	986,25
OP1020-125	125	370	220	1098,00
OP1020-150	150	380	225	1201,00
OP1020-200	200	400	230	2024,00
OP1020-250	250	420	240	3698,75
OP1020-300	300	440	250	5540,50
OP1020-350	350	460	260	7786,00
OP1020-400	400	480	270	10604,00
OP1020-450	450	500	280	11634,00
OP1020-500	500	520	290	12252,00

Flangerør 250mm DUKTILJERN



Flangerør i duktilt støbejern med DIN PN10 flanger.
Byggelængde 250mm.

Varenr.	DN	PN	DKK
OP1022-40	40	10/16	470,00
OP1022-50	50	10/16	548,75
OP1022-65	65	10/16	686,25
OP1022-80	80	10/16	913,50
OP1022-100	100	10/16	914,50
OP1022-125	125	10/16	1397,75
OP1022-150	150	10/16	1452,50
OP1022-200	200	10/16	2235,25
OP1022-250	250	10	2754,25
OP1022-300	300	10	3833,75

Flangerør 500mm

DUKTILJERN



Flangerør i duktilt støbejern med DIN PN10 flanger.
Byggelængde 500mm.

Varenr.	DN	PN	DKK
OP1024-40	40	10/16	658,00
OP1024-50	50	10/16	730,00
OP1024-65	65	10/16	960,50
OP1024-80	80	10/16	968,50
OP1024-100	100	10/16	1238,25
OP1024-125	125	10/16	2057,00
OP1024-150	150	10/16	2100,25
OP1024-200	200	10/16	3180,75
OP1024-250	250	10	4771,00
OP1024-300	300	10	4604,25
OP1024-400	400	10	9239,25
OP1024-450	500	10	14250,25

Blindflange m. 2" anbring

DUKTILJERN



Andre anbringninger kan leveres på forespørgsel.

Varenr.	DN	Byg L	DKK
OP1032-50	50	19	212,25
OP1032-65	65	19	246,25
OP1032-80	80	19	258,75
OP1032-100	100	19	286,50
OP1032-125	125	19	390,50
OP1032-150	150	19	463,50
OP1032-200	200	20	642,75
OP1032-250	250	22	952,75
OP1032-300	300	24,5	1352,50
OP1032-400	400	24,5	2151,75
OP1032-500	500	26,5	3688,00

Blindflange

DUKTILJERN



Varenr.	DN	Byg L	DKK
OP1030-50	50	19	150,50
OP1030-65	65	19	184,50
OP1030-80	80	19	196,75
OP1030-100	100	19	224,75
OP1030-125	125	19	295,25
OP1030-150	150	19	372,00
OP1030-200	200	20	550,75
OP1030-250	250	22	861,25
OP1030-300	300	24,5	1230,00
OP1030-400	400	24,5	1998,25
OP1030-500	500	26,5	3381,00

Løsflange 2-delt

DUKTILJERN



Todelt DIN PN10 løsflange i duktilt støbejern, kan også leveres i PN16 og PN25.

Varenr.	DN	PN	DKK
OP1036-40	40	10/16	159,50
OP1036-50	50	10/16	159,50
OP1036-65	65	10/16	162,75
OP1036-80	80	10/16	165,00
OP1036-100	100	10/16	232,75
OP1036-125	125	10/16	249,25
OP1036-150	150	10/16	280,75
OP1036-200	200	10/16	373,50
OP1036-250	250	10	717,50
OP1036-300	300	10	1059,00
OP1036-350	350	10	1386,50
OP1036-400	400	10	1648,00
OP1036-450	450	10	2997,50
OP1036-500	500	10	3745,25
OP1036-600	600	10	6294,50

T-stk m. 2-delte løsflanger

DUKTILJERN



DIN PN10/16 T-stk i duktilt støbejern.

Varenr.	DN	Byg L	DKK
OP1040-50	50	280	891,00
OP1040-6540	65×40×65	305	1048,75
OP1040-65	65	305	1048,75
OP1040-80	80	330	1278,25
OP1040-10080	100×80×100	330	1417,50
OP1040-100	100	360	1417,50
OP1040-125100	125×100×125	370	1839,75
OP1040-125	125	400	1839,75
OP1040-15050	150×50×150	340	2413,50
OP1040-150100	150×100×150	380	2413,50
OP1040-150	150	440	2195,00
OP1040-200	200	520	3458,75
OP1040-250200	250×200×250	540	6928,00
OP1040-250	250	600	6928,00
OP1040-300100	300×100×300	450	8920,00
OP1040-300200	300×200×300	565	8920,00
OP1040-300	300	680	8920,00
OP1040-400	400	840	17355,50
OP1040-500400	500×400×500	885	25951,00
OP1040-500	500	1000	25951,00

T-stk 45° m. 2-delte løsflanger

DUKTILJERN



DIN PN10/16 45° T-stk i duktilt støbejern.

Varenr.	DN	DKK
OP1042-50	50	4227,25
OP1042-65	65	4524,00
OP1042-80	80	UDGÅET
OP1042-100	100	3209,50
OP1042-125	125	7200,75
OP1042-150	150	8708,75
OP1042-200	200	12267,50
OP1042-250	250	13034,75
OP1042-300	300	25482,25
OP1042-350	350	34546,25
OP1042-400	400	43600,00
OP1042-450	450	55182,25
OP1042-500	500	66764,75

Kryds m. 2-delte løsflanger

DUKTILJERN



DIN PN10/16 kryds i duktilt støbejern.

Varenr.	DN	Byg L	DKK
OP1050-40	40	255	2405,25
OP1050-50	50	280	2405,25
OP1050-6550	65×50	305	2589,50
OP1050-65	65	305	2589,50
OP1050-8050	80×50	310	3458,75
OP1050-8065	80×65	310	3458,75
OP1050-80	80	330	3458,75
OP1050-10050	100×50	320	4095,50
OP1050-10065	100×65	320	4095,50
OP1050-10080	100×80	330	4095,50
OP1050-100	100	360	4095,50
OP1050-12580	125×80	350	4700,00
OP1050-125100	125×100	370	4700,00
OP1050-125	125	400	4700,00
OP1050-15080	150×80	360	5240,75
OP1050-150100	150×100	380	5240,75
OP1050-150	150	440	5240,75
OP1050-200100	200×100	400	7998,00
OP1050-200150	200×150	460	7998,00
OP1050-200	200	520	7998,00

UDLØBSKLAPPER



max 0,5 bar



Stort program af udløbsklapper i HDPE til de fleste typer rør.
Nemme at montere. Fås større og til højere tryk ved forespørgsel.

Udløbsklap, vægtype

HDPE



AISI 316 modvægt. EPDM tætning.

Max 0,5 bar.

Varenr.	Ø	DKK
OP1110-100	100	3062,25
OP1110-125	125	3488,75
OP1110-150	150	4072,75
OP1110-200	200	4594,00
OP1110-250	250	5375,75
OP1110-300	300	8780,75
OP1110-400	400	8698,50
OP1110-500	500	10233,25
OP1110-600	600	22284,25
OP1110-700	700	26095,25
OP1110-800	800	29483,75
OP1110-900	900	34015,75
OP1110-1000	1000	43105,50

Udløbsklap 15° m. vægflange

HDPE



AISI 316 modvægt. EPDM tætning.

Max 0,5 bar.

Varenr.	Ø	DKK
OP1112-100	100	4203,50
OP1112-125	125	4594,00
OP1112-150	150	5188,25
OP1112-200	200	6084,25
OP1112-250	250	7397,50
OP1112-300	300	8780,75
OP1112-350	350	10495,75
OP1112-400	400	12216,00
OP1112-500	500	20965,75
OP1112-600	600	29710,50
OP1112-700	700	35545,50
OP1112-800	800	41607,00
OP1112-900	900	49002,25
OP1112-1000	1000	¤

¤ = spørg på pris

Udløbsklap 15° m. DIN flange

HDPE

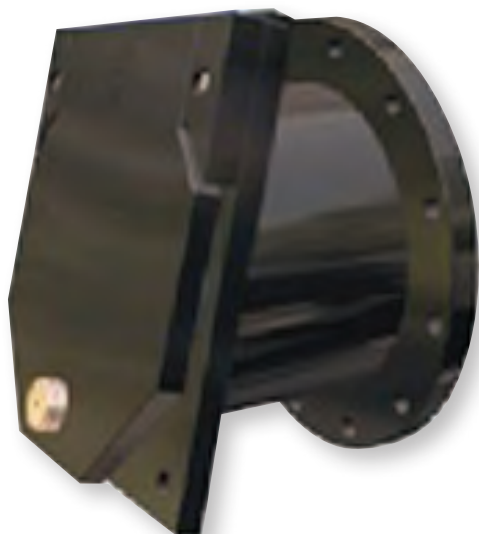

AISI 316 modvægt. EPDM tætning.

Max 0,5bar.

Varenr.	DN	DKK
OP1114-100	100	3649,50
OP1114-125	125	4006,75
OP1114-150	150	4463,00
OP1114-200	200	4952,25
OP1114-250	250	5603,25
OP1114-300	300	8775,75
OP1114-400	400	11350,75
OP1114-500	500	9646,00
OP1114-600	600	21372,50

Udløbsklap 15° m. spidsende til beton

HDPE

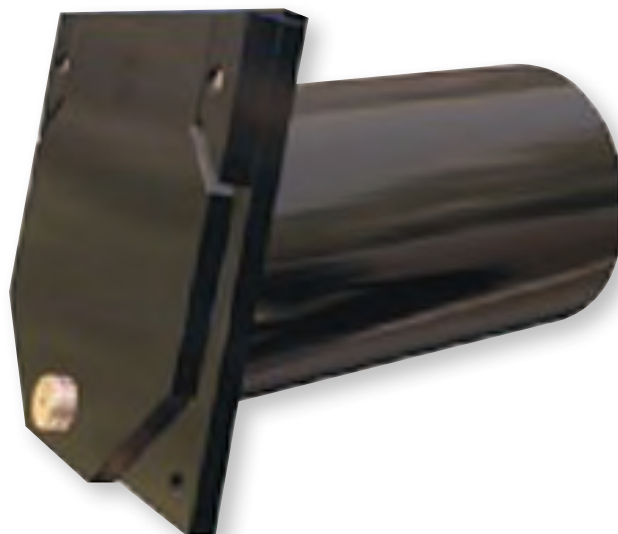

AISI 316 modvægt. EPDM tætning.

Max 0,5bar.

Varenr.	Ø	DKK
OP1118-100	100	6386,00
OP1118-125	125	4918,25
OP1118-150	150	5705,25
OP1118-200	200	6572,50
OP1118-250	250	8068,00
OP1118-300	300	9728,50
OP1118-400	400	13518,75
OP1118-500	500	17005,50
OP1118-600	600	29417,00
OP1118-700	700	33912,75
OP1118-800	800	43388,75
OP1118-900	900	51083,00
OP1118-1000	1000	63757,00

Udløbsklap 15° m. spidsende til PE

HDPE



AISI 316 modvægt. EPDM tætning.

Max 0,5bar.

Varenr.	Ø	DKK
OP1116-300	300	α
OP1116-400	400	10068,25
OP1116-500	500	11793,50
OP1116-600	600	23885,75
OP1116-700	700	28247,75
OP1116-800	800	32546,00
OP1116-900	900	37796,00
OP1116-1000	1000	48317,50

α = spørg på pris

PAKNINGER TIL VAND OG SPILDEVAND



NBR/DVGW: -25°C til +90°C
EPDM/KTW, W270:
-25°C til +120°C



Gummipakning NBR / STÅL



Gummipakning EPDM / STÅL



Med stålindlæg

Varenr.	DN	ø/Ø	Byg L	DKK
OP1200-15	15	22/51	3-4	43,25
OP1200-20	20	27/61	3-4	44,00
OP1200-25	25	34/71	3-4	48,90
OP1200-32	32	43/82	3-4	56,25
OP1200-40	40	49/92	3-4	57,90
OP1200-50	50	61/107	4-5	64,95
OP1200-65	65	77/127	4-5	64,40
OP1200-80	80	89/142	3-4	66,10
OP1200-100	100	115/162	4-5	75,65
OP1200-125	125	141/192	4-5	86,55
OP1200-150	150	169/218	4-5	107,75
OP1200-200	200	220/273	5-6	142,25
OP1200-250	250	273/328	5-6	145,75
OP1200-300	300	324/378	5-6	206,00
OP1200-350	350	368/438	6-7	303,25
OP1200-400	400	420/489	6-7	361,00
OP1200-450	450	470/540	7-9	365,25
OP1200-500	500	520/594	6-7	596,25
OP1200-600	600	620/695	6-7	746,75
OP1200-700	700	712/810	7-8	1116,75
OP1200-800	800	813/917	7-8	1432,75
OP1200-900	900	915/1017	7-8	1893,25
OP1200-1000	1000	1016/1124	7-8	3717,50
OP1200-1200	1200	1220/1341	8-10	5544,50

Med stålindlæg

Varenr.	DN	ø/Ø	Byg L	DKK
OP1202-32	32	43/82	3-4	56,25
OP1202-40	40	49/92	3-4	57,90
OP1202-50	50	61/107	4-5	62,80
OP1202-65	65	77/127	4-5	64,40
OP1202-80	80	89/142	3-4	67,20
OP1202-100	100	115/162	4-5	76,20
OP1202-125	125	141/192	4-5	88,75
OP1202-150	150	169/218	4-5	108,50
OP1202-200	200	220/273	5-6	138,50
OP1202-250	250	273/328	5-6	144,25
OP1202-300	300	324/378	5-6	209,75
OP1202-350	350	368/438	6-7	303,25
OP1202-400	400	420/489	6-7	353,00
OP1202-450	450	470/540	7-9	365,25
OP1202-500	500	520/594	6-7	596,25
OP1202-600	600	620/695	6-7	724,50
OP1202-700	700	712/810	7-8	1116,75
OP1202-800	800	813/917	7-8	1609,00
OP1202-900	900	915/1017	7-8	1893,25
OP1202-1000	1000	1016/1124	7-8	1991,00
OP1202-1200	1200	1220/1341	8-10	5536,25
OP1202-1400	1400			6893,00
OP1202-1600	1600			7382,00
OP1202-1800	1800			9425,00
OP1202-2000	2000			10799,75

Gummipakning 0-8°

EPDM



Indstillelig 0-8°

Varenr.	DN	DKK
OP1204-80	80	2173,50
OP1204-100	100	2522,50
OP1204-150	150	3045,75
OP1204-200	200	3690,50
OP1204-250	250	5391,25
OP1204-300	300	9167,00
OP1204-350	350	9754,25
OP1204-400	400	12025,25
OP1204-500	500	15146,25

Flangepakning 1,5mm

PULP



Højtryksplade, asbestfri

Varenr.	DN	ø	DKK
000685018	10	18	5,95
000685021	15	22	6,80
000685027	20	28	5,85
000685034	25	35	7,15
000685042	32	43	8,40
000685048	40	49	9,60
000685060	50	61	13,45
000685076	65	77	16,45
000685089	80	90	19,55
000685114	100	115	23,75
000685133	125	133	31,00 ^α
000685139	125	141	31,00
000685168	150	169	40,25
000685219	200	220	57,60
000685273	250	274	82,15
000685324	300	325	106,50
000685368	350	368	139,75
000685420	400	420	172,25
000685462	450	462	209,50
000685520	500	520	246,50
000685620	600	620	403,00

^α = så længe lager haves

RØRGENNEMFØRINGER



Rørgennemføringer:
-30°C til +120°C
Inner-Links: -40°C til +80°C



Bruges, hvor et rundt rør går gennem en mur og udfylder mellemrummet med en stram, permanent tætning.

FORDELE:

- hurtig montering
- genanvendelig
- fleksibel
- økonomisk løsning
- elektrisk isolerende
- nem lagerstyring

Rørgennemføring

EPDM / METAL = AISI 304



Rørgennemføring til alle typer rør.
Max 5bar

Varenr.	Hul ø	Rør Ø	DKK
OP1314-50-12	50	6-12	318,00
OP1314-70-32	70	24-32	457,00
OP1314-70-41	70	32-41	457,75
OP1314-80-28	80	20-28	495,75
OP1314-80-40	80	32-40	534,00
OP1314-100-28	100	20-28	590,25
OP1314-100-32	100	25-32	646,75
OP1314-100-40	100	32-40	703,25
OP1314-100-44	100	36-44	760,00
OP1314-100-56	100	46-56	564,50
OP1314-100-65	100	55-65	564,50
OP1314-125-64	125	55-64	676,00
OP1314-125-70	125	61-70	676,00
OP1314-125-78	125	70-78	787,25
OP1314-150-54	150	46-54	1141,25
OP1314-150-66	150	56-66	1495,75
OP1314-150-78	150	69-78	1121,75
OP1314-150-91	150	79-91	1256,75
OP1314-150-94	150	85-94	1121,75
OP1314-150-110	150	98-110	1121,75
OP1314-200-103	200	88-103	1903,50
OP1314-200-115	200	108-115	1540,00
OP1314-200-126	200	116-126	1632,75
OP1314-200-128	200	119-128	1725,25
OP1314-200-141	200	132-141	1725,25

OP1314-200-144	200	135-144	2074,50
OP1314-200-160	200	150-160	2074,50
OP1314-250-144	250	135-144	2074,50
OP1314-250-149	250	140-149	2221,75
OP1314-250-159	250	150-159	2221,75
OP1314-250-162	250	157-162	2562,75
OP1314-250-165	250	156-165	2904,75
OP1314-250-175	250	165-175	2157,00
OP1314-250-181	250	174-181	2157,00
OP1314-250-187	250	178-187	2157,00
OP1314-250-202	250	197-202	2157,00
OP1314-250-210	250	204-210	2414,50
OP1314-300-187	300	178-187	2522,50
OP1314-300-204	300	193-204	2628,75
OP1314-300-207	300	198-207	2736,75
OP1314-300-226	300	218-226	2844,00
OP1314-350-233	350	224-233	3115,75
OP1314-350-258	350	249-258	3386,75
OP1314-350-282	350	270-282	4577,50
OP1314-400-280	400	270-280	4577,50
OP1314-400-288	400	279-288	4863,75
OP1314-400-313	400	304-313	4863,75
OP1314-400-323	400	314-323	4588,75
OP1314-400-330	400	320-330	4588,75

Leveringstid 3-6 dage for skaffeverer

Rørgennemføring

EPDM / METAL = AISI 316



Rørgennemføring til alle typer rør.
Max 5bar

Varenr.	Hul ø	Rør Ø	DKK
OP1316-50-12	50	6-12	541,75
OP1316-70-32	70	24-32	548,25
OP1316-70-41	70	32-41	554,75
OP1316-80-28	80	20-28	600,50
OP1316-80-40	80	32-40	646,50
OP1316-100-28	100	20-28	713,25
OP1316-100-32	100	25-32	756,25
OP1316-100-40	100	32-40	831,25
OP1316-100-44	100	36-44	912,00
OP1316-100-56	100	46-56	759,00
OP1316-100-65	100	55-65	759,00
OP1316-125-64	125	55-64	894,50
OP1316-125-70	125	61-70	879,75
OP1316-125-78	125	70-78	1030,00
OP1316-150-54	150	46-54	1269,00
OP1316-150-66	150	56-66	1269,00
OP1316-150-78	150	69-78	1508,00
OP1316-150-91	150	79-91	1508,00
OP1316-150-94	150	85-94	1346,25
OP1316-150-110	150	98-110	1508,00
OP1316-200-103	200	88-103	1847,00
OP1316-200-115	200	108-115	1882,00
OP1316-200-126	200	116-126	1976,75
OP1316-200-128	200	119-128	2069,50

OP1316-200-141	200	132-141	2244,50
OP1316-200-144	200	135-144	2489,75
OP1316-200-160	200	150-160	2050,75
OP1316-250-144	250	135-144	2368,00
OP1316-250-149	250	140-149	2719,25
OP1316-250-159	250	150-159	2767,75
OP1316-250-162	250	157-162	3128,25
OP1316-250-165	250	156-165	3485,75
OP1316-250-175	250	165-175	2584,50
OP1316-250-181	250	174-181	3485,75
OP1316-250-187	250	178-187	3136,50
OP1316-250-202	250	197-202	2896,50
OP1316-250-210	250	204-210	2586,50
OP1316-300-187	300	178-187	3330,00
OP1316-300-204	300	193-204	4190,25
OP1316-300-207	300	198-207	3936,75
OP1316-300-226	300	218-226	3822,50
OP1316-350-233	350	224-233	4187,00
OP1316-350-258	350	249-258	4551,75
OP1316-350-282	350	270-282	5492,00
OP1316-400-280	400	270-280	5665,00
OP1316-400-288	400	279-288	5711,50
OP1316-400-313	400	304-313	5839,25
OP1316-400-323	400	314-323	5139,75
OP1316-400-330	400	320-330	5508,50

Rørgennemføring 2-delt

EPDM / METAL = AISI 304



Rørgennemføring til alle typer rør.

Max 5bar

Varenr.	Hul ø	Rør Ø	DKK
OP1310-70-32	70	24-32	396,00
OP1310-70-41	70	32-41	396,00
OP1310-80-28	80	20-28	536,00
OP1310-80-40	80	32-40	536,00
OP1310-100-28	100	20-28	676,00
OP1310-100-32	100	25-32	676,00
OP1310-100-40	100	32-40	676,00
OP1310-100-44	100	36-44	676,00
OP1310-100-56	100	46-56	676,00
OP1310-100-65	100	55-65	676,00
OP1310-125-64	125	55-64	900,25
OP1310-125-78	125	70-78	900,25
OP1310-150-91	150	79-91	1290,75
OP1310-150-110	150	98-110	1290,75
OP1310-200-103	200	88-103	1745,00
OP1310-200-115	200	108-115	1745,00
OP1310-200-126	200	116-126	1745,00
OP1310-200-141	200	132-141	1745,00
OP1310-200-160	200	150-160	1745,00
OP1310-250-144	250	135-144	2215,75
OP1310-250-162	250	157-162	2215,75
OP1310-250-165	250	156-165	2215,75
OP1310-250-181	250	174-181	2215,75
OP1310-250-202	250	197-202	2361,00
OP1310-250-210	250	204-210	2361,00
OP1310-300-187	300	178-187	2946,00
OP1310-300-204	300	193-204	2946,00
OP1310-300-226	300	218-226	2946,00
OP1310-400-280	400	270-280	4143,75
OP1310-400-330	400	320-330	4143,75



Rør diameter		Hul størrelse	Min	Max	InnerLinks antal	Total længde i mm. L	OP1302 EPDM	op1304 EPDM	op1306 NBR	op1308 SILIKONE	
ND	mm	Ø	up Ø	to Ø		se tegning	stålrør og kabler	plastrør	bestandig benzin og olie	-55°C til +204°C	
10	17,2	50	49,2	56	4	IL 275	63	OP1302-1	OP1304-1	OP1306-1	OP1308-1
15	21,3	50	50,3	52,7	4	IL 200	63	OP1302-2	OP1304-2	OP1306-2	OP1308-2
20	26,9	50	48,1	51,9	4	IL 100	60	OP1302-3	OP1304-3	OP1306-3	OP1308-3
	26,9	80	77,9	90	4	IL 340	100	OP1302-4	OP1304-4	OP1306-4	OP1308-4
25	33,7	60	59,7	65,1	5	IL 200	63	OP1302-5	OP1304-5	OP1306-5	OP1308-5
	33,7	70	65,7	72	6	IL 275	63	OP1302-6	OP1304-6	OP1306-6	OP1308-6
32	42,4	80	80,6	82,4	8	IL 275	63	OP1302-7	OP1304-7	OP1306-7	OP1308-7
	42,4	100	93,4	102	5	IL 340	100	OP1302-8	OP1304-8	OP1306-8	OP1308-8
40	48,3	70	67,8	73,3	6	IL 100	60	OP1302-9	OP1304-9	OP1306-9	OP1308-9
	48,3	100	93,8	100	6	IL 315	90	OP1302-10	OP1304-10	OP1306-10	OP1308-10
	48,3	125	119,2	132,3	5	IL 360	100	OP1302-11	OP1304-11	OP1306-11	OP1308-11
50	60,3	80	78,3	85,3	7	IL 100	60	OP1302-12	OP1304-12	OP1306-12	OP1308-12
	60,3	100	96,3	105	6	IL 300	90	OP1302-13	OP1304-13	OP1306-13	OP1308-13
	60,3	125	124,3	133,8	5	IL 360	100	OP1302-14	OP1304-14	OP1306-14	OP1308-14
65	76,1	100	97,4	101,1	9	IL 100	60	OP1302-15	OP1304-15	OP1306-15	OP1308-15
	76,1	125	118,3	128,1	8	IL 315	90	OP1302-16	OP1304-16	OP1306-16	OP1308-16
	76,1	150	140,1	155	6	IL 360	100	OP1302-17	OP1304-17	OP1306-17	OP1308-17
80	88,9	125	120,9	128,9	8	IL 265	63	OP1302-18	OP1304-18	OP1306-18	OP1308-18
	88,9	125	125,0	133	8	IL 300	90	OP1302-19	OP1304-19	OP1306-19	OP1308-19
	88,9	150	143,6	156,9	9	IL 340	100	OP1302-20	OP1304-20	OP1306-20	OP1308-20
100	114,3	150	146,3	154,3	10	IL 265	63	OP1302-21	OP1304-21	OP1306-21	OP1308-21
	114,3	150	150,0	159	7	IL 310	90	OP1302-22	OP1304-22	OP1306-22	OP1308-22
	114,3	200	196,3	211	7	IL 475	125	OP1302-23	OP1304-23	OP1306-23	OP1308-23
	114,3	225	222,7	230,3	7	IL 575	140	OP1302-24	OP1304-24	OP1306-24	OP1308-24
125	139,7	200	196,3	207,7	13	IL 340	100	OP1302-25	OP1304-25	OP1306-25	OP1308-25
	139,7	210	206,9	223,7	10	IL 360	100	OP1302-26	OP1304-26	OP1306-26	OP1308-26
	139,7	225	221,7	236,7	8	IL 475	125	OP1302-27	OP1304-27	OP1306-27	OP1308-27
	139,7	250	247,9	255,7	8	IL 575	140	OP1302-28	OP1304-28	OP1306-28	OP1308-28
	139,7	300	277,7	304	6	IL 650	165	OP1302-29	OP1304-29	OP1306-29	OP1308-29
150	168,3	210	205,0	213,3	10	IL 310	90	OP1302-30	OP1304-30	OP1306-30	OP1308-30
	168,3	225	222,7	236,3	15	IL 340	100	OP1302-31	OP1304-31	OP1306-31	OP1308-31
	168,3	250	242,4	260,3	7	IL 400	125	OP1302-32	OP1304-32	OP1306-32	OP1308-32
	168,3	300	288,3	310	7	IL 500	140	OP1302-33	OP1304-33	OP1306-33	OP1308-33
200	219,1	260	256,0	264,1	13	IL 310	90	OP1302-34	OP1304-34	OP1306-34	OP1308-34
	219,1	300	294,5	316,1	12	IL 410	125	OP1302-35	OP1304-35	OP1306-35	OP1308-35
	219,1	350	343,1	362,1	9	IL 500	140	OP1302-36	OP1304-36	OP1306-36	OP1308-36
	219,1	400	388,0	417	9	IL 625	165	OP1302-37	OP1304-37	OP1306-37	OP1308-37
250	273	310	309,0	318	16	IL 310	90	OP1302-38	OP1304-38	OP1306-38	OP1308-38
	273	340	337,0	346	17	IL 360	100	OP1302-39	OP1304-39	OP1306-39	OP1308-39
	273	350	347,0	354	14	IL 410	125	OP1302-40	OP1304-40	OP1306-40	OP1308-40
	273	400	393,0	405	10	IL 500	140	OP1302-41	OP1304-41	OP1306-41	OP1308-41
	273	450	435,0	466	7	IL 615	165	OP1302-42	OP1304-42	OP1306-42	OP1308-42
300	323,9	400	395,9	415	12	IL 400	125	OP1302-43	OP1304-43	OP1306-43	OP1308-43
	323,9	400	387,9	407,9	20	IL 360	100	OP1302-44	OP1304-44	OP1306-44	OP1308-44
	323,9	450	443,9	463	12	IL 500	140	OP1302-45	OP1304-45	OP1306-45	OP1308-45
	323,9	500	490,0	515	12	IL 625	165	OP1302-46	OP1304-46	OP1306-46	OP1308-46
350	355,6	400	399,4	407,6	31	IL 315	90	OP1302-47	OP1304-47	OP1306-47	OP1308-47
	355,6	450	437,6	452	18	IL 475	125	OP1302-48	OP1304-48	OP1306-48	OP1308-48
	355,6	490	475,6	498,6	13	IL 500	140	OP1302-49	OP1304-49	OP1306-49	OP1308-49
	355,6	500	493,6	505	12	IL 650	165	OP1302-50	OP1304-50	OP1306-50	OP1308-50
	355,6	550	545,6	575,6	9	IL 700	165	OP1302-51	OP1304-51	OP1306-51	OP1308-51
400	406,4	500	495,0	510	14	IL 440	125	OP1302-52	OP1304-52	OP1306-52	OP1308-52
	406,4	550	544,4	565	14	IL 650	165	OP1302-53	OP1304-53	OP1306-53	OP1308-53
	406,4	600	596,4	626,4	10	IL 700	165	OP1302-54	OP1304-54	OP1306-54	OP1308-54
450	457	510	503,4	517	19	IL 325	100	OP1302-55	OP1304-55	OP1306-55	OP1308-55
	457	550	546,0	567	16	IL 440	125	OP1302-56	OP1304-56	OP1306-56	OP1308-56
	457	600	595,0	605	15	IL 650	165	OP1302-57	OP1304-57	OP1306-57	OP1308-57
	457	650	626,0	655	16	IL 625	165	OP1302-58	OP1304-58	OP1306-58	OP1308-58
500	508	560	554,4	568	21	IL 325	100	OP1302-59	OP1304-59	OP1306-59	OP1308-59
	508	600	597,0	610	17	IL 440	125	OP1302-60	OP1304-60	OP1306-60	OP1308-60
	508	650	646,0	660	17	IL 650	165	OP1302-61	OP1304-61	OP1306-61	OP1308-61
	508	700	694,0	704	18	IL 625	165	OP1302-62	OP1304-62	OP1306-62	OP1308-62
550	559	610	605,4	619	23	IL 325	100	OP1302-63	OP1304-63	OP1306-63	OP1308-63
	559	650	647,0	669	19	IL 440	125	OP1302-64	OP1304-64	OP1306-64	OP1308-64
	559	700	697,0	710	18	IL 650	165	OP1302-65	OP1304-65	OP1306-65	OP1308-65
	559	750	724,3	755	19	IL 625	165	OP1302-66	OP1304-66	OP1306-66	OP1308-66
600	610	660	656,4	670	25	IL 325	100	OP1302-67	OP1304-67	OP1306-67	OP1308-67
	610	700	694,8	707	30	IL 475	125	OP1302-68	OP1304-68	OP1306-68	OP1308-68
	610	750	748,0	778	20	IL 650	165	OP1302-69	OP1304-69	OP1306-69	OP1308-69
	610	800	792,2	806	21	IL 625	165	OP1302-70	OP1304-70	OP1306-70	OP1308-70

InnerLinks til stålrør og kabler

EPDM / METAL = AISI 316



Shore 50. Max 5bar.

Til kabler, stål- og jernrør.

Temp: -40°C til +80°C

- Er netop blevet forbedret på flere punkter:
- Mindre tilspændingsmoment og bedre tæthed vha. forbedrede trykplader og optimerede skruer
- Vand og radon tæthed er certificeret
- Beregningsprogrammer kan hentes online som Apps til Apple og Android

Varenr.	Type	Antal	DKK
	Enkelte led		
OP1302-100	100	1 × 100	35,85
OP1302-200	200	1 × 200	45,70
OP1302-265	265	1 × 265	91,95
OP1302-275	275	1 × 275	62,80
OP1302-300	300	1 × 300	83,30
OP1302-310	310	1 × 310	116,25
OP1302-315	315	1 × 315	124,50
OP1302-325	325	1 × 325	185,75
OP1302-340	340	1 × 340	188,00
OP1302-360	360	1 × 360	211,75
OP1302-400	400	1 × 400	269,00
OP1302-410	410	1 × 410	227,75
OP1302-425	425	1 × 425	248,25
OP1302-440	440	1 × 440	312,25
OP1302-475	475	1 × 475	248,25
OP1302-500	500	1 × 500	497,25
OP1302-525	525	1 × 525	476,75
OP1302-575	575	1 × 575	456,25
OP1302-650	650	1 × 650	681,25

InnerLinks til plastrør

EPDM / METAL = AISI 316



Shore 35. Max 3bar.

Til plastrør.

Temp: -40°C til +80°C

- Er netop blevet forbedret på flere punkter:
- Mindre tilspændingsmoment og bedre tæthed vha. forbedrede trykplader og optimerede skruer
- Vand og radon tæthed er certificeret
- Beregningsprogrammer kan hentes online som Apps til Apple og Android

Varenr.	Type	Antal	DKK
	Enkelte led		
OP1304-200	200	1 × 200	42,15
OP1304-265	265	1 × 265	101,50
OP1304-275	275	1 × 275	86,95
OP1304-300	300	1 × 300	95,05
OP1304-315	315	1 × 315	108,50
OP1304-325	325	1 × 325	205,50
OP1304-340	340	1 × 340	159,50
OP1304-360	360	1 × 360	191,50
OP1304-400	400	1 × 400	295,75
OP1304-410	410	1 × 410	262,00
OP1304-425	425	1 × 425	273,25
OP1304-440	440	1 × 440	426,75
OP1304-475	475	1 × 475	273,25
OP1304-500	500	1 × 500	547,50
OP1304-525	525	1 × 525	524,25
OP1304-575	575	1 × 575	501,75
OP1304-625	625	1 × 625	705,75
OP1304-650	650	1 × 650	936,50
OP1304-700	700	1 × 700	1165,00

InnerLinks olie+benzin bestandig

NBR / METAL = AISI 316



Shore 50. Max 5bar.

Olie og benzinbestandig, ikke UV-bestandig.

Temp: -40°C til +70°C

- Er netop blevet forbedret på flere punkter:
- Mindre tilspændingsmoment og bedre tæthed vha. forbedrede trykplader og optimerede skruer
- Vand og radon tæthed er certificeret
- Beregningsprogrammer kan hentes online som Apps til Apple og Android

Varenr.	Type	Antal	DKK
	Enkelte led		
OP1306-200	200	1 × 200	46,70
OP1306-275	275	1 × 275	73,45
OP1306-265	265	1 × 265	118,75
OP1306-300	300	1 × 300	99,35
OP1306-315	315	1 × 315	119,25
OP1306-325	325	1 × 325	223,00
OP1306-340	340	1 × 340	174,00
OP1306-360	360	1 × 360	208,25
OP1306-400	400	1 × 400	323,50
OP1306-410	410	1 × 410	286,00
OP1306-425	425	1 × 425	298,50
OP1306-440	440	1 × 440	464,00
OP1306-475	475	1 × 475	298,50
OP1306-500	500	1 × 500	596,75
OP1306-525	525	1 × 525	571,75
OP1306-575	575	1 × 575	547,50
OP1306-625	625	1 × 625	784,00
OP1306-650	650	1 × 650	1021,75

InnerLinks -55°C til +204°C

SILICONE / METAL = STÅL

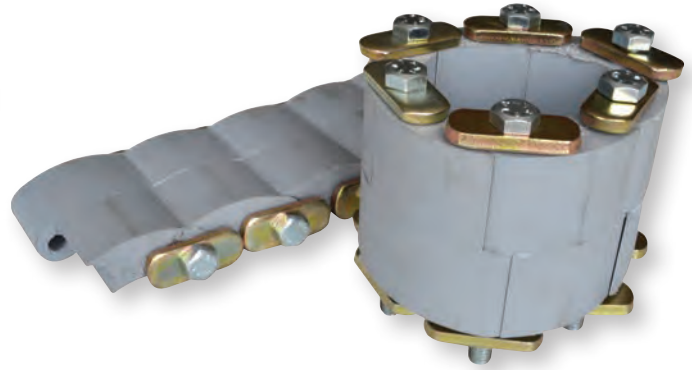

Shore 50. Max 5bar.

Temp: -55°C til +204°C

- Er netop blevet forbedret på flere punkter:
- Mindre tilspændingsmoment og bedre tæthed vha. forbedrede trykplader og optimerede skruer
- Vand og radon tæthed er certificeret
- Beregningsprogrammer kan hentes online som Apps til Apple og Android

Varenr.	Type	Antal	DKK
	Enkelte led		
OP1308-200	200	1 × 200	115,75
OP1308-275	275	1 × 275	138,00
OP1308-300	300	1 × 300	156,00
OP1308-315	315	1 × 315	240,25
OP1308-325	325	1 × 325	450,00
OP1308-340	340	1 × 340	613,00
OP1308-360	360	1 × 360	797,25
OP1308-400	400	1 × 400	666,75
OP1308-410	410	1 × 410	1021,75
OP1308-425	425	1 × 425	666,75
OP1308-475	475	1 × 475	666,75
OP1308-500	500	1 × 500	1245,50
OP1308-525	525	1 × 525	1245,50
OP1308-575	575	1 × 575	1245,50

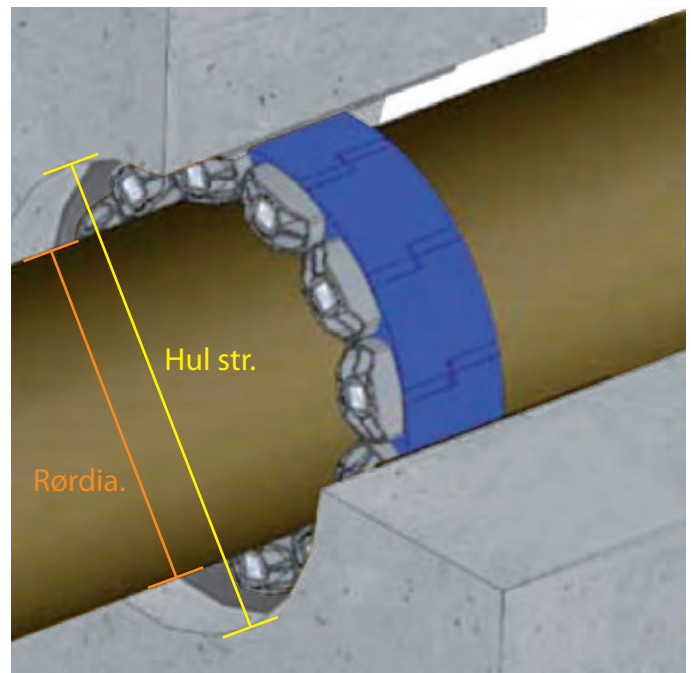

RENSEGRISE



Til rensning af rør.

Fremgangsmåde:

- Første gang altid en blød svamp af relativt blødt skumgummi.
- Hvis røret er meget tilstoppet, så nøjes første gang med en svamp med samme eller måske en lidt mindre diameter end rørets lysning.
- Derefter med en svamp med samme diameter som lysning, og til sidst en svamp med lidt større diameter end rørets lysning.
- Normalt pumpetryk skal som udgangspunkt være tilstrækkeligt.

Rensegris gul coated

PE (POLYETHYLEN)



Lav vægtfylde			
Varenr.	Dim	Ø	DKK
OP1408-9	2"	59	578,50
OP1408-10	2 1/2"	72	613,25
OP1408-11	3"	85	613,25
OP1408-12	4"	111	784,00
OP1408-13	5"	136	886,75
OP1408-14	6"	166	989,50
OP1408-15	8"	216	1616,75
OP1408-16	10"	266	2205,25
OP1408-17	12"	318	3422,25

Rensegris blå coated

PE (POLYETHYLEN)



Medium vægtfylde				
Varenr.	Dim	Ø	L	DKK
OP1409-9	2"	59	120	820,00
OP1409-10	2 1/2"	72	120	869,00
OP1409-11	3"	85	145	869,00
OP1409-12	4"	111	200	1060,00
OP1409-13	5"	136	245	1292,50
OP1409-14	6"	166	320	1522,00
OP1409-15	8"	216	420	2254,25
OP1409-16	10"	266	520	3244,75
OP1409-17	12"	318	610	4467,75

Rensegris rød coated

PE (POLYETHYLEN)



Høj vægtfylde

Varenr.	Dim	Ø	L	DKK
OP1410-9	2"	59	120	821,75
OP1410-10	2 1/2"	72	120	886,75
OP1410-11	3"	85	145	886,75
OP1410-12	4"	111	200	1076,25
OP1410-13	5"	136	245	1319,00
OP1410-14	6"	166	320	1567,75
OP1410-15	8"	216	420	2351,25
OP1410-16	10"	266	520	3422,25
OP1410-17	12"	318	610	4698,25

Rensegris blå

PE (POLYETHYLEN)



Medium vægtfylde

Varenr.	Dim	Ø	L	DKK
OP1419-9	2"	56	120	402,75
OP1419-10	2 1/2"	69	120	425,50
OP1419-11	3"	82	145	425,50
OP1419-12	4"	108	200	495,00
OP1419-13	5"	133	245	608,75
OP1419-14	6"	163	320	722,75
OP1419-15	8"	213	420	1112,00
OP1419-16	10"	263	520	1761,75
OP1419-17	12"	315	610	2601,00

Rensegris gul

PE (POLYETHYLEN)



Lav vægtfylde

Varenr.	Dim	Ø	DKK
OP1418-9	2"	56	175,25
OP1418-10	2 1/2"	69	189,25
OP1418-11	3"	82	189,25
OP1418-12	4"	108	218,75
OP1418-13	5"	133	265,00
OP1418-14	6"	163	342,75
OP1418-15	8"	213	492,00
OP1418-16	10"	263	740,75
OP1418-17	12"	315	1097,75

Rensegris rød

PE (POLYETHYLEN)



Høj vægtfylde

Varenr.	Dim	Ø	L	DKK
OP1420-9	2"	56	120	405,50
OP1420-10	2 1/2"	69	120	465,00
OP1420-11	3"	82	145	465,00
OP1420-12	4"	108	200	530,00
OP1420-13	5"	133	245	648,75
OP1420-14	6"	163	320	767,75
OP1420-15	8"	213	420	1205,75
OP1420-16	10"	263	520	1941,25
OP1420-17	12"	315	610	2730,75

VANDFILTRE



710 STANDARD FILTRE



713 HOT FILTRE



714 MINI FILTRE



715 FILTRE MED DRÆN



717 BIG FILTRE



718 BIG SANI FILTRE



719 DIVERSE FILTRE

STANDARD FILTRE



Max 8 bar (ved 20°C)



5°C til 45°C



I dette afsnit findes filtre til filtrering af væske, fortrinsvis vand, samt tilhørende indsætte.

FILTERINDSATSE

Har en filtreringsgrad, som angives på 2 måder:

MICRON angiver, hvor store partikler kan gå igennem filteret. Jo mindre tallet for micron er, jo tættere er filteret.

MESH angiver antal tråde per tomme. Jo højere tallet for mesh er, jo tættere er filteret.

Filter

PE (POLYETHYLEN) / PP (POLYPROPYLEN)



Max 8 bar, max temp: +45°C.
Med indvendige BSPP gevinder.

Filter

PE (POLYETHYLEN) / PP (POLYPROPYLEN)



Max 8 bar, max temp: +45°C.
Med indvendige BSPP gevinder.
Anvendes udenfor eller hvor filtret udsættes for sollys. Uigennemsiigtigt filter forhindrer dannelse af alger.

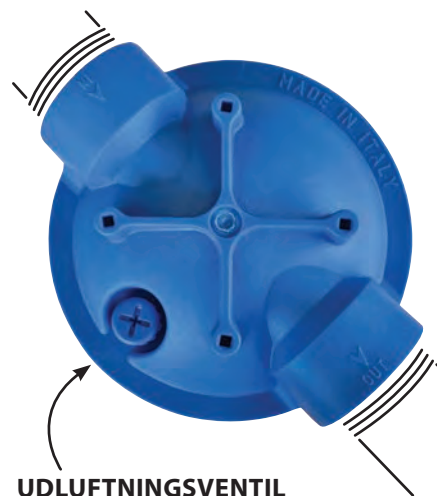

Leveres uden filterindsats

Varenr.	BSPP	Str.	HxBxD	DKK
FA1-4-5	1/2"	5"	191x133x130	310,50
FA1-5-5	3/4"	5"	191x133x130	324,75
FA1-6-5	1"	5"	197x145x130	338,75

FA1-4-7	1/2"	7"	241x133x130	319,25
FA1-5-7	3/4"	7"	241x133x130	333,25

FA1-4-10	1/2"	10"	315x133x130	338,75
FA1-5-10	3/4"	10"	315x133x130	353,50
FA1-6-10	1"	10"	321x145x130	367,25

FA1-4-20	1/2"	20"	571x133x130	919,50
FA1-5-20	3/4"	20"	571x133x130	933,75
FA1-6-20	1"	20"	577x145x130	951,25

Leveres uden filterindsats

Varenr.	BSPP	Str.	HxBxD	DKK
FA2-4-5	1/2"	5"	191x133x130	319,25
FA2-5-5	3/4"	5"	191x133x130	333,25
FA2-6-5	1"	5"	197x145x130	350,50

FA2-4-7	1/2"	7"	241x133x130	327,75
FA2-5-7	3/4"	7"	241x133x130	341,50
FA2-6-7	1"	7"	247x145x130	358,75

FA2-4-10	1/2"	10"	315x133x130	350,50
FA2-5-10	3/4"	10"	315x133x130	364,50
FA2-6-10	1"	10"	321x145x130	381,75

FA2-4-20	1/2"	20"	571x133x130	999,50
FA2-5-20	3/4"	20"	571x133x130	1013,75
FA2-6-20	1"	20"	577x145x130	1027,75

Filter

PP (POLYPROPYLEN) - BSPP



Max 8 bar, max temp: +45°C.

Leveres uden filterindsats

Varenr.	BSPP	Str.	HxBxD	DKK
FAPP-5-5	3/4"	5"	191x133x130	315,00
FAPP-6-5	1"	5"	197x145x130	315,00
FAPP-5-7	3/4"	7"	241x133x130	339,75
FAPP-6-7	1"	7"	247x145x130	339,75
FAPP-5-10	3/4"	10"	315x133x130	411,00
FAPP-6-10	1"	10"	321x145x130	411,00
FAPP-5-20	3/4"	20"	571x133x130	1361,75
FAPP-6-20	1"	20"	577x145x130	1361,75

Filterindsats spundet

PP (POLYPROPYLEN)



Engangsindsats, max +45°C

Varenr.	Str.	Micron	L/time	DKK
FA20-5-1	5"	1	1000	57,10
FA20-5-10	5"	10	1000	49,00
FA20-5-25	5"	25	1000	46,30
FA20-5-50	5"	50	1000	46,30
FA20-5-100	5"	100	1000	46,30
FA20-7-1	7"	1	1400	59,80
FA20-7-10	7"	10	1400	51,75
FA20-7-25	7"	25	1400	49,00
FA20-7-50	7"	50	1400	49,00
FA20-7-100	7"	100	1400	49,00
FA20-10-1	10"	1	2000	65,55
FA20-10-10	10"	10	2000	54,45
FA20-10-25	10"	25	2000	51,75
FA20-10-50	10"	50	2000	51,75
FA20-10-100	10"	100	2000	51,75
FA20-20-1	20"	1	3000	158,00
FA20-20-10	20"	10	3000	133,25
FA20-20-25	20"	25	3000	127,75
FA20-20-50	20"	50	3000	127,75
FA20-20-100	20"	100	3000	127,75

ANVENDELSESOMRÅDER:

Filtrerer: sand, grus, ler, rust, fine partikler.

Generel brug: Filtrering og behandling af drikkevand, beskyttelse af vandhaner, kedler, vaskemaskiner og andre installationer.

Teknisk brug: Forfiltrering for vandpumper, vandingsystemer, beskyttelse af applikationer indenfor f.eks. overfladebehandling samt kemisk, petrokemisk, fotografisk og farmaceutisk industri.

Gennemsnitlig levetid: fra 3 til 6 måneder.

Vedligeholdelse: ingen

Specifikationer: Giftfri materialer, kan bruges til drikkevand.

Materiale: polypropylen

Filterindsats støbt

PP (POLYPROPYLEN)



Engangsindsats, max +80°C

Varenr.	Str.	Micron	L/time	DKK
FA21-5-1	5"	1	1000	59,80
FA21-5-5	5"	5	1000	51,75
FA21-5-10	5"	10	1000	49,00
FA21-5-25	5"	25	1000	49,00
FA21-5-50	5"	50	1000	49,00
FA21-7-1	7"	1	1400	65,55
FA21-7-5	7"	5	1400	54,45
FA21-7-10	7"	10	1400	51,75
FA21-7-25	7"	25	1400	51,75
FA21-7-50	7"	50	1400	51,75
FA21-10-1	10"	1	2000	61,15
FA21-10-5	10"	5	2000	57,10
FA21-10-10	10"	10	2000	54,70
FA21-10-25	10"	25	2000	51,80
FA21-10-50	10"	50	2000	51,80
FA21-20-1	20"	1	3000	146,25
FA21-20-5	20"	5	3000	141,50
FA21-20-10	20"	10	3000	133,75
FA21-20-25	20"	25	3000	128,00
FA21-20-50	20"	50	3000	129,50

ANVENDELSESOMRÅDER:

Højeffektiv filtrering af: sand, grus, ler, rust, fine partikler.

Generel brug: Filtrering og behandling af drikkevand, beskyttelse af vandhaner, kedler, vaskemaskiner og andre installationer.

Teknisk brug: Forfiltrering for omvendt osmose membraner og for alle applikationer, hvor der er brug for effektiv finpartikel tilbageholdelse. Filtrering af vand og andre væsker i industrien: overfladebehandling, kemisk, petrokemisk, fotografisk og farmaceutisk industri. Forfilter for UV lampeenheder. Efterfilter for aktivt kul enheder.

Gennemsnitlig levetid: max. 6 måneder.

Vedligeholdelse: ingen

Specifikationer: Giftfri materialer, kan bruges til drikkevand.

Materiale: polypropylen

Filterindsats PP (POLYPROPYLEN)



Vaskbar, max +45°C

Varenr.	Str.	Micron	L/time	DKK
FA23-5-50	5"	50	1200	102,00
FA23-7-50	7"	50	1700	179,75
FA23-10-50	10"	50	2500	209,00
FA23-20-50	20"	50	4000	406,00

Filterindsats AISI 316 / PP (POLYPROPYLEN)



Vaskbar, max +45°C

Varenr.	Str.	Micron	L/time	DKK
FA24-5-50	5"	50	1500	777,25
FA24-7-50	7"	50	2000	967,50
FA24-10-50	10"	50	3000	1212,50
FA24-20-50	20"	50	4500	2541,25

Vægbeslag



Varenr.	Str.	DKK
FA0-2	-	46,80

Spændering



Varenr.	Str.	DKK
FA0-1	-	71,00

O-ring/pakning

NBR



Til FA filterhuse

Varenr.	Str.	DKK
FA0-3	-	12,75

HOT FILTRE



Max 8 bar (ved 20°C)



5°C til 80°C



I dette afsnit findes filtre til filtrering af væske, fortrinsvis vand, samt tilhørende indsats.

MICRON angiver, hvor store partikler kan gå igennem filteret. Jo mindre tallet for micron er, jo tættere er filteret.

FILTERINDSATSE

Har en filtreringsgrad, som angives på 2 måder:

MESH angiver antal tråde per tomme. Jo højere tallet for mesh er, jo tættere er filteret.

Filter HOT NYLON - BSPP



Leveres uden filterindsats

Varenr.	BSPP	Str.	HxBxD	DKK
FA5-4-5	1/2"	5"	191x133x130	550,25
FA5-5-5	3/4"	5"	191x133x130	545,75
FA5-6-5	1"	5"	197x145x130	558,25
FA5-4-7	1/2"	7"	241x133x130	589,50
FA5-5-7	3/4"	7"	241x133x130	584,75
FA5-6-7	1"	7"	247x145x130	597,25
FA5-4-10	1/2"	10"	315x133x130	863,75
FA5-5-10	3/4"	10"	315x133x130	863,75
FA5-6-10	1"	10"	321x145x130	863,75
FA5-4-20	1/2"	20"	571x133x130	2435,00
FA5-5-20	3/4"	20"	571x133x130	2435,00
FA5-6-20	1"	20"	577x145x130	2435,00

Filterindsats HOT PP (POLYPROPYLEN)



Engangsindsats, max +80°C

Varenr.	Str.	Micron	L/time	DKK
FA22-5-1	5"	1	1000	66,10
FA22-5-10	5"	10	1000	56,85
FA22-5-25	5"	25	1000	53,85
FA22-5-50	5"	50	1000	53,85
FA22-5-100	5"	100	1000	53,85
FA22-7-1	7"	1	1400	71,80
FA22-7-10	7"	10	1400	59,80
FA22-7-25	7"	25	1400	56,85
FA22-7-50	7"	50	1400	56,85
FA22-7-100	7"	100	1400	56,85
FA22-10-1	10"	1	2000	74,55
FA22-10-10	10"	10	2000	59,25
FA22-10-25	10"	25	2000	55,45
FA22-10-50	10"	50	2000	55,45
FA22-10-100	10"	100	2000	55,45
FA22-20-1	20"	1	3000	168,75
FA22-20-10	20"	10	3000	156,00
FA22-20-25	20"	25	3000	147,25
FA22-20-50	20"	50	3000	141,00
FA22-20-100	20"	100	3000	142,25

Vægbeslag



Varenr.	Str.	DKK
FA0-2	-	46,80

Spændering



Varenr.	Str.	DKK
FA0-1	-	71,00

O-ring/pakning

NBR



Til FA filterhuse

Varenr.	Str.	DKK
FA0-3	-	12,75

MINI FILTRE



Max 8 bar (ved 20°C)



5°C til 45°C



I dette afsnit findes MINI filtre til filtrering af væske, fortrinsvis vand, samt tilhørende indsætte.

FILTERINDSATSE

Har en filtreringsgrad, som angives på 2 måder:

MICRON angiver, hvor store partikler kan gå igennem filteret. Jo mindre tallet for micron er, jo tættere er filteret.

MESH angiver antal tråde per tomme. Jo højere tallet for mesh er, jo tættere er filteret.

Filter MINI

SAN / PP (POLYPROPYLEN) - BSPP



Inkl. filterindsats

Varenr.	BSPP	Element	HxBxD	DKK
FAM1-1	3/8"	PP	65x74x50	364,50
FAM1-2	3/8"	RS 304	65x74x50	517,75

Filterindsats MINI spundet

PP (POLYPROPYLEN)



70 %

DISCOUNT

Engangsindsats, max +80°C

Varenr.	Dim	Str.	Micron	DKK
FF20M-5-1	3/4"	5"	1	11,10 ₺
FF20M-5-25	3/4"	5"	25	10,70 ₺

₺ = så længe lager haves

Vægbeslag MINI



70 %

DISCOUNT

Varenr.	Str.	DKK
FF51M-1	-	10,50 ₺

₺ = så længe lager haves

Filterindsats MINI

PP (POLYPROPYLEN)



Varenr.	Dim	Micron	L/time	DKK
FAM10-1	3/8"	1000	600	51,15

Filterindsats MINI

AISI 316



70 %

DISCOUNT

Vaskbar, max +95°C

Varenr.	Dim	Str.	Micron	DKK
FF23M-5-60	3/4"	5"	60	97,85 ₺

₺ = så længe lager haves

Vægbeslag MINI

STÅL

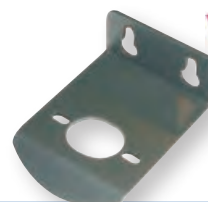

70 %

DISCOUNT

Varenr.	Str.	DKK
FF52M-1	-	60,45 ₺

₺ = så længe lager haves

Filterindsats MINI

AISI 304 / PP (POLYPROPYLEN)



Varenr.	Dim	Micron	L/time	DKK
FAM11-1	3/8"	300	500	204,25

Spændering MINI



70 %

DISCOUNT

Varenr.	Str.	DKK
FF62M-1	-	36,40 ₺

₺ = så længe lager haves

FILTRE M. DRÆN



Max 8 bar (ved 20°C)



5°C til 45°C



I dette afsnit findes et filter med dræn til filtrering af væske, fortrinsvis vand, samt tilhørende indsats.

FILTERINDSATSE

Har en filtreringsgrad, som angives på 2 måder:

MICRON angiver, hvor store partikler kan gå igennem filteret. Jo mindre tallet for micron er, jo tættere er filteret.

MESH angiver antal tråde per tomme. Jo højere tallet for mesh er, jo tættere er filteret.

Filter med DRÆN

PE (POLYETHYLEN) / PP (POLYPROPYLEN)



Leveres uden filterindsats

Varenr.	BSPP	Str.	HxBxD	DKK
FAD1-4-10	1/2"	10"	450x133x130	706,00
FAD1-5-10	3/4"	10"	450x133x130	716,50
FAD1-6-10	1"	10"	460x145x130	750,25
FAD1-4-20	1/2"	20"	710x133x130	791,75
FAD1-5-20	3/4"	20"	710x133x130	859,50
FAD1-6-20	1"	20"	720x145x130	893,25

Drænsæt til FAD1, FB1 og FB2 (Inklusiv i varen)



Filterindsats DRÆN spundet

PP (POLYPROPYLEN)



Engangsindsats, max +45°C

Varenr.	Str.	Micron	L/tim	DKK
FAD20-10-1	10"	1	2000	72,90
FAD20-10-5	10"	5	2000	67,20
FAD20-10-10	10"	10	2000	64,45
FAD20-10-25	10"	25	2000	61,15
FAD20-10-50	10"	50	2000	61,15
FAD20-10-100	10"	100	2000	61,15
FAD20-20-1	20"	1	3000	221,25
FAD20-20-5	20"	5	3000	203,25
FAD20-20-10	20"	10	3000	194,50
FAD20-20-25	20"	25	3000	184,75
FAD20-20-50	20"	50	3000	184,75
FAD20-20-100	20"	100	3000	184,75

Filterindsats DRÆN støbt

PP (POLYPROPYLEN)



Engangsindsats, max +80°C

Varenr.	Str.	Micron	L/tim	DKK
FAD21-10-1	10"	1	2000	86,30
FAD21-10-5	10"	5	2000	80,85
FAD21-10-10	10"	10	2000	81,90
FAD21-10-25	10"	25	2000	78,65
FAD21-10-50	10"	50	2000	80,85
FAD21-20-1	20"	1	3000	255,50
FAD21-20-5	20"	5	3000	161,75
FAD21-20-10	20"	10	3000	161,75
FAD21-20-25	20"	25	3000	156,25
FAD21-20-50	20"	25	3000	156,25

Tids+intervalstyret aftapn.



Varenr.	Str.	DKK
FAD-KIT	-	5905,00

Spændering



Varenr.	Str.	DKK
FA0-1	-	71,00

Vægbeslag



Varenr.	Str.	DKK
FA0-2	-	46,80

O-ring/pakning

NBR



Til FA filterhuse

Varenr.	Str.	DKK
FA0-3	-	12,75

BIG FILTRE



Max 8 bar (ved 20°C)



5°C til 45°C



BIG filtre til de store behov og heavy duty filteropgaver. Kommer med dræn.

FILTERINDSATSE

Har en filtreringsgrad, som angives på 2 måder:

MICRON angiver, hvor store partikler kan gå igennem filteret. Jo mindre tallet for micron er, jo tættere er filteret.

MESH angiver antal tråde per tomme. Jo højere tallet for mesh er, jo tættere er filteret.

Filter BIG med dræn SAN / PP (POLYPROPYLEN) - BSPP



Leveres uden filterindsats

Varenr.	BSPP	Str.	HxBxD	DKK
FB1-6-10	1"	10"	480x190x185	1348,50
FB1-8-10	1 1/2"	10"	480x190x185	1348,50

FB1-6-20	1"	20"	737x190x185	1665,75
FB1-8-20	1 1/2"	20"	737x190x185	1665,75

Drænsæt til FAD1, FB1 og FB2 (Inklusiv i varen)



Filter BIG med dræn PP (POLYPROPYLEN) - BSPP



Leveres uden filterindsats

Varenr.	BSPP	Str.	HxBxD	DKK
FB2-6-10	1"	10"	480x190x185	1241,25
FB2-8-10	1 1/2"	10"	480x190x185	1241,25

FB2-6-20	1"	20"	737x190x185	1444,25
FB2-8-20	1 1/2"	20"	737x190x185	1444,25

Vægbeslag



Varenr.	Str.	DKK
FB-2	-	642,00

Filterindsats BIG spundet PP (POLYPROPYLEN)



Engangsindsats, max +45°C

Varenr.	Str.	Micron	L/time	DKK
FB20-10-1	10"	1	2500	296,50
FB20-10-5	10"	5	2500	271,50
FB20-10-10	10"	10	2500	259,50
FB20-10-25	10"	25	2500	246,75
FB20-10-50	10"	50	2500	246,75
FB20-10-100	10"	100	2500	246,75

FB20-20-1	20"	1	4000	620,25
FB20-20-5	20"	5	4000	569,00
FB20-20-10	20"	10	4000	542,75
FB20-20-25	20"	25	4000	516,75
FB20-20-50	20"	50	4000	516,75
FB20-20-100	20"	100	4000	515,50

Spændering



Varenr.	Str.	DKK
FB-1	-	69,35

BIG SANI FILTRE



Max 8 bar (ved 20°C)



5°C til 45°C



SANI filtre er behandlet med sølv, både filter og filterindsats. De kan IKKE rense vand, men behandlingen hindrer dannelsen af bakterier på overflader, der i berøring med vand.

FILTERINDSATSE

Har en filtreringsgrad, som angives på 2 måder:

MICRON angiver, hvor store partikler kan gå igennem filteret. Jo mindre tallet for micron er, jo tættere er filteret.

MESH angiver antal tråde per tomme. Jo højere tallet for mesh er, jo tættere er filteret.

Filter BIG SANI

PP (POLYPROPYLEN) - BSPP



Leveres uden filterindsats

Varenr.	BSPP	Str.	HxBxD	DKK
FBS4-6-10	1"	10"	360x190x185	1215,50
FBS4-8-10	1 1/2"	10"	360x190x185	1215,50
FBS4-6-20	1"	20"	617x190x185	1547,25
FBS4-8-20	1 1/2"	20"	617x190x185	1547,25

Filterindsats BIG SANI spundet

PP (POLYPROPYLEN)



Engangsindsats, max +45°C

Varenr.	Str.	Micron	L/time	DKK
FBS40-10-1	10"	1	2500	464,25
FBS40-10-5	10"	5	2500	424,75
FBS40-10-10	10"	10	2500	406,25
FBS40-10-25	10"	25	2500	386,75
FBS40-10-50	10"	50	2500	386,75
FBS40-10-100	10"	100	2500	386,75
FBS40-20-1	20"	1	4000	900,75
FBS40-20-5	20"	5	4000	825,50
FBS40-20-10	20"	10	4000	788,25
FBS40-20-25	20"	25	4000	751,25
FBS40-20-50	20"	50	4000	751,25
FBS40-20-100	20"	100	4000	751,25

Vægbeslag



Varenr.	Str.	DKK
FB-2	-	642,00

Spændering



Varenr.	Str.	DKK
FB-1	-	69,35

DIVERSE FILTRE



Max 8 bar (ved 20°C)



5°C til 45°C



I dette afsnit findes et bredt udvalg af filtre til filtrering af væske, fortrinsvis vand, samt tilhørende indsats.

FILTERINDSATSE

Har en filtreringsgrad, som angives på 2 måder:

MICRON angiver, hvor store partikler kan gå igennem filteret. Jo mindre tallet for micron er, jo tættere er filteret.

MESH angiver antal tråde per tomme. Jo højere tallet for mesh er, jo tættere er filteret.



Filter med 1/2 til 1 1/2" gevind - 10 bar max

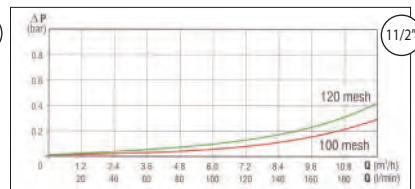
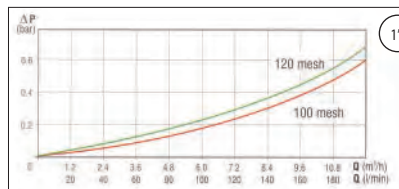
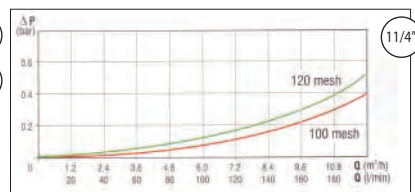
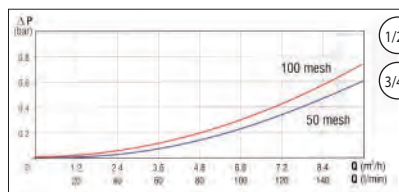

Filter med 2 eller 3" gevind - 8 bar max

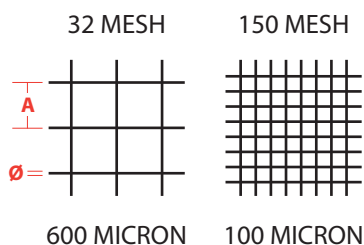
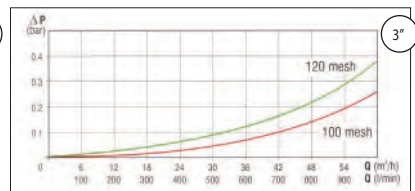
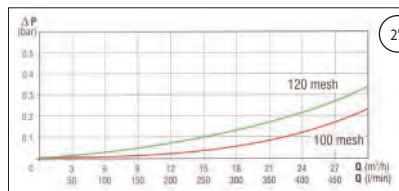

MESH	A (microns)	Ø (microns)	S (%)	Materiale
32	500	320	37,1	PolyPropylen (PP)
32	594	200	55,3	Rustfri
50	365	140	50,8	Rustfri
80	229	80	55,7	Rustfri
100	173	80	46,4	Rustfri
120	134	70	43	PolyAmid (PA)
120	144	70	45,4	Rustfri
150	96	65	35	PolyAmid (PA)
150	114	60	42,4	Rustfri
200	80	50	37	PolyAmid (PA)
200	76	50	36,2	Rustfri

FILTER

Farvekoden i filterindsatsen svarer til en bestemt MESH-værdi (antal af wire i inch (25,4mm)). Det gør det derfor nemmere at vælge den rigtige filterindsats, når den skal installeres i anlægget eller maskinen.

MESH Antal tråde per tomme (25.4mm)

- A Effektiv gennemgang
- Ø Tråd diameter
- S Forholdet mellem gennemgang og trådareal.

Filter inkl. prop
PP (POLYPROPYLEN) - BSPP



Max +50°C.

Filterelement = AISI 316

Varenr.	BSPP	Mesh	L/min	DKK
FA11-1	1/2"	50	80	209,25
FA11-4	1/2"	100	80	209,25
FA12-1	3/4"	50	80	209,25
FA12-4	3/4"	100	80	209,25
FA13-1	1"	50	100	209,25
FA13-3	1"	100	100	209,25
FA14-1	1 1/4"	50	140	389,50
FA14-4	1 1/4"	100	140	389,50
FA15-1	1 1/2"	50	160	479,25
FA15-4	1 1/2"	100	160	479,25
FA16-1	2"	32	380	1555,50
FA17-2	2"	100	380	1555,50
FA18-1	3"	32	800	2605,00 α
FA19-2	3"	100	800	2605,00 α

α = med spændebånd

O-ring/pakning t. filterhus
EPDM



Varenr.	dim	DKK
FA25-4	1/2" - 3/4"	8,80
FA25-6	1"	14,75
FA25-7	1 1/4" - 2"	21,30
FA25-10	3"	54,00

O-ring til filterhus (FA25)

Løse indsatse leveres inkl. o-ringe

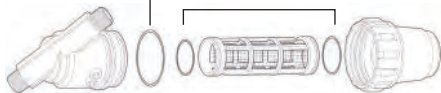

Filterindsats m. EPDM O-ring
PP (POLYPROPYLEN) / AISI 316



Varenr.	Dim	Mesh	L/min	DKK
FA16-1-32	2"	32	380	222,25
FA18-1-32	3"	32	800	384,50

Filterindsats m. EPDM O-ring
PP (POLYPROPYLEN) / AISI 316



Varenr.	Dim	Mesh	L/min	DKK
FA11-1-100	1/2"-3/4"	100	80	72,90
FA13-1-100	1"	100	100	80,25
FA14-1-100	1 1/4"	100	140	134,50
FA15-1-100	1 1/2"	100	160	130,75
FA16-1-100	2"	100	380	225,50
FA18-1-100	3"	100	800	415,50

Filterindsats m. EPDM O-ring
PP (POLYPROPYLEN)



PA trådnæt: 1/2" til 1 1/2"
PE trådnæt: 3"

Filterindsats m. EPDM O-ring
PP (POLYPROPYLEN) / AISI 316



Varenr.	Dim	Mesh	L/min	DKK
FA11-1-50	1/2"-3/4"	50	80	69,90
FA13-1-50	1"	50	100	76,70
FA14-1-50	1 1/4"	50	140	90,90
FA15-1-50	1 1/2"	50	160	124,75
FA16-1-50	2"	50	380	236,00
FA18-1-50	3"	50	800	405,75

Filterindsats m. EPDM O-ring
PP (POLYPROPYLEN)



PA trådnæt: 1/2" til 1 1/2"
PE trådnæt: 3"

Filterindsats m. EPDM O-ring
PP (POLYPROPYLEN) / AISI 316



Varenr.	Dim	Mesh	L/min	DKK
FA13-1-80	1"	80	100	79,45
FA14-1-80	1 1/4"	80	140	127,50
FA15-1-80	1 1/2"	80	160	127,50
FA16-1-80	2"	80	380	241,75
FA18-1-80	3"	80	800	405,75

Varenr.	Dim	Mesh	L/min	DKK
FA11-1-150	1/2"-3/4"	150	80	72,90
FA13-1-150	1"	150	100	83,00
FA14-1-150	1 1/4"	150	140	138,00
FA15-1-150	1 1/2"	150	160	132,00
FA18-1-150	3"	150	800	405,75

Filterindsats dobbelt
PP (POLYPROPYLEN) / AISI 316



Inkl. EPDM O-ring

Varenr.	Dim	Mesh	L/min	DKK
FA15-1-8032	1 1/2"	80/32	160	138,00
FA16-1-8032	2"	80/32	380	262,25
FA18-1-8032	3"	80/32	800	405,75

Filterindsats dobbelt
PP (POLYPROPYLEN) / AISI 316



Inkl. EPDM O-ring

Varenr.	Dim	Mesh	L/min	DKK
FA15-1-15032	1 1/2"	150/32	160	140,50
FA16-1-15032	2"	150/32	380	281,75
FA18-1-15032	3"	150/32	800	435,50

Filterindsats dobbelt
PP (POLYPROPYLEN) / AISI 316



Inkl. EPDM O-ring

Varenr.	Dim	Mesh	L/min	DKK
FA15-1-10032	1 1/2"	100/32	160	140,50
FA16-1-10032	2"	100/32	380	272,50
FA18-1-10032	3"	100/32	800	415,50

Filterindsats dobbelt
PP (POLYPROPYLEN) / AISI 316



Inkl. EPDM O-ring

Varenr.	Dim	Mesh	L/min	DKK
FA15-1-20032	1 1/2"	200/32	160	140,50
FA16-1-20032	2"	200/32	380	281,75
FA18-1-20032	3"	200/32	800	435,50

Filterindsats dobbelt
PP (POLYPROPYLEN) / AISI 316



Inkl. EPDM O-ring

Varenr.	Dim	Mesh	L/min	DKK
FA15-1-12032	1 1/2"	120/32	160	140,50
FA16-1-12032	2"	120/32	380	281,75
FA18-1-12032	3"	120/32	800	435,50

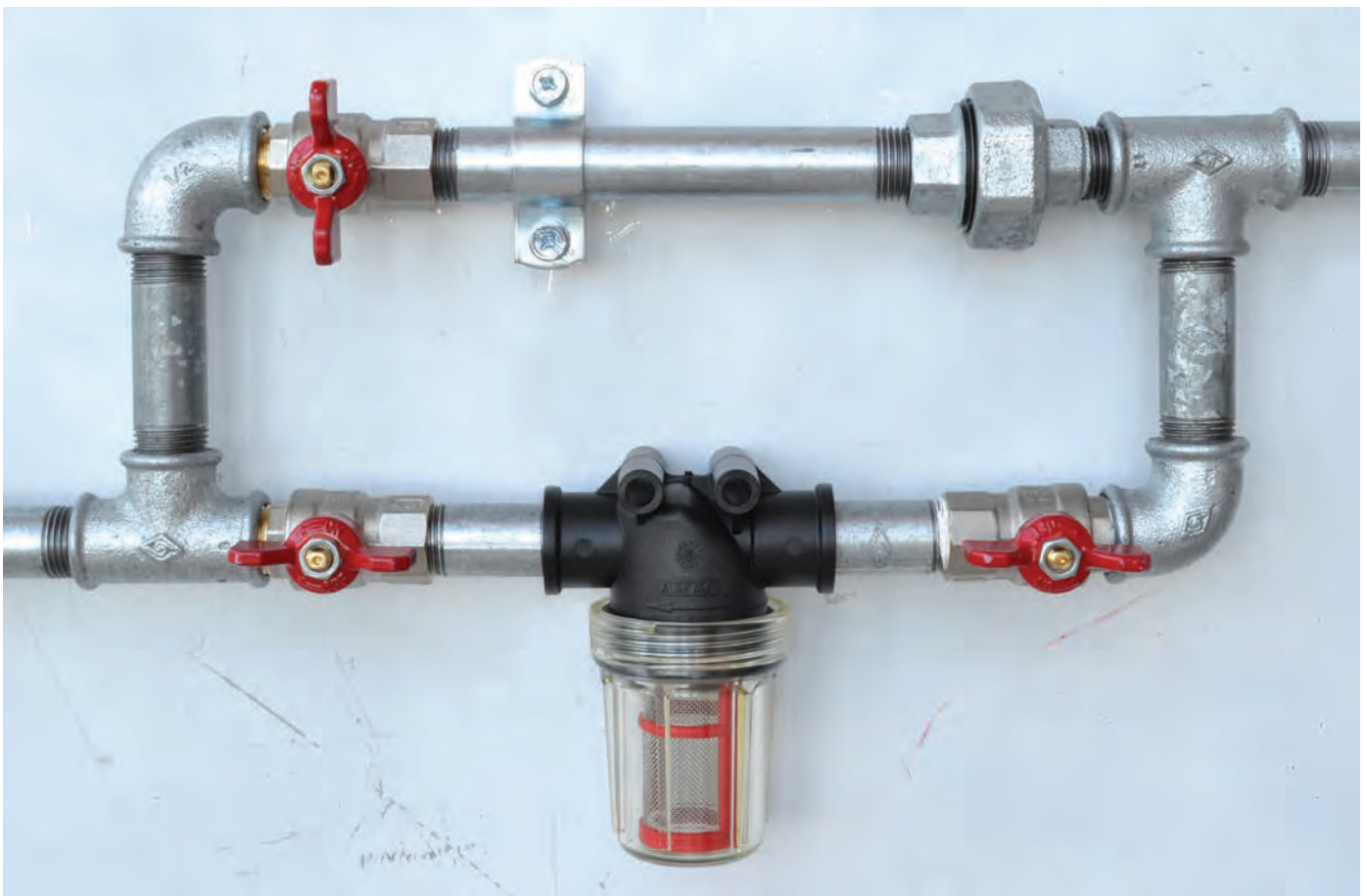

Filter

PP (POLYPROPYLEN) / PA (POLYAMID)



Max 10bar, 1/2" BSPP tilslutning

Varenr.	Mesh	L/min 0.5bar	H	DKK
FA70-1	32	55	110mm	163,00
FA70-2	50	55	110mm	163,00
FA70-3	80	55	110mm	163,00
FA70-4	100	55	110mm	163,00

Filterindsats

PP (POLYPROPYLEN) / AISI 316



Max 10 bar

Varenr.	Mesh	L/min 0.5bar	DKK
FA71-1	32	55	56,85
FA71-2	50	55	56,85
FA71-3	80	55	56,85
FA71-4	100	55	56,85

Højtryksfilter

PA (POLYAMID) - BSPP



Max 50 bar.

Filterelement = AISI 316

Varenr.	A	B	Mesh	L/min	DKK
FA9-1	2-1/2"	2-3/4"	32	150	777,75
FA9-2	2-1/2"	2-3/4"	50	150	777,75
FA9-3	2-3/4"	2-3/4"	80	150	777,75

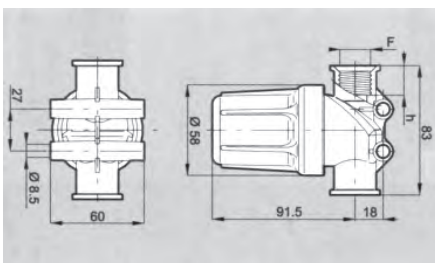

32 MESH

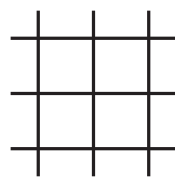

600 MICRON

150 MESH

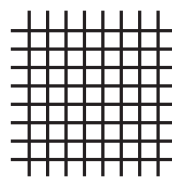

100 MICRON

Flydefilter

PP (POLYPROPYLEN) / AISI 316



Varenr.	Ø	D	L	DKK
FA72-1	30	186	203	465,75
FA72-2	33	186	203	465,75
FA72-3	40	186	203	465,75
FA72-4	50	186	203	465,75
FA72-5	60	186	203	465,75
FA72-6	30	186	265	638,00
FA72-7	33	186	265	638,00
FA72-8	40	186	265	638,00
FA72-9	50	186	265	638,00
FA72-10	60	186	265	638,00

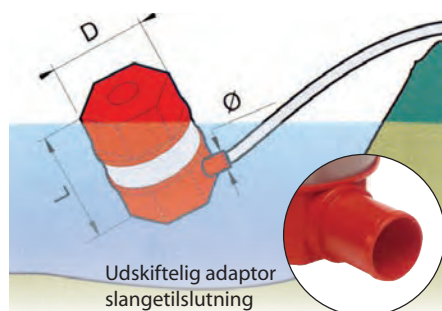

Slangetilslutning til FA72

PP (POLYPROPYLEN)



Varenr.	Ø	DKK
FA73-1	30	31,55
FA73-2	33	31,55
FA73-3	40	31,55
FA73-4	50	31,55
FA73-5	60	31,55

Sugefilter

PP (POLYPROPYLEN)



Varenr.	Ø	D	L	DKK
Fi8-1	8	15	20	10,60

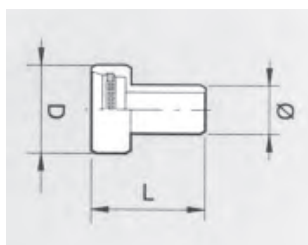

Filter

AISI 316

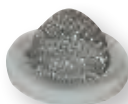

Varenr.	Mesh	Ø	DKK
Fi3-1	32	15mm	8,15
Fi3-2	50	15mm	8,15
Fi3-3	100	15mm	8,15

Filter

PP (POLYPROPYLEN) / AISI 316



Varenr.	Mesh	Ø × H	DKK
Fi4-1	50	14,6 × 21	13,85
Fi4-2	100	14,6 × 21	14,75

Filter m. kontraventil

PA (POLYAMID) / AISI 316

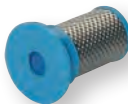

Varenr.	Mesh	Ø × H	DKK
Fi2-1	50	14,6 × 21	14,75
Fi2-2	100	14,6 × 21	16,30

Filter

PA (POLYAMID) / AISI 316



L=28mm, filter Ø: 7mm

Varenr.	Udv.xindv.	Mesh	DKK
Fi9-1	1/8"	100	80,85

Vandfilter push-on

PP (POLYPROPYLEN)



Varenr.	Ø/ø	Mesh	DKK
A48-1	8/6	100	71,55

Vandfilter push-on

PP (POLYPROPYLEN)



Med kontraventil

Varenr.	Ø/ø	Mesh	DKK
A48-2	8/6	100	70,15

Sugefilter

PA (POLYAMID) / AISI 316



Med kontravægt af messing

Varenr.	Ø	D	L	DKK
Fi7-1	8	21	41	28,70

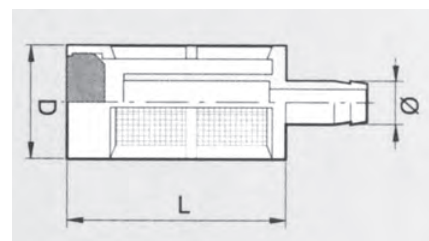

Filter

AISI 304 / PA (POLYAMID) - BSPT



Varenr.	Dim	DKK
E370-4	1/2"	25,60
E370-5	3/4"	29,25
E370-6	1"	31,30
E370-7	1 1/4"	28,35
E370-8	1 1/2"	34,15
E370-9	2"	45,90
E370-10	2 1/2"	101,25
E370-11	3"	126,50
E370-12	4"	200,50

Sugefilter 32 mesh

PA (POLYAMID) / AISI 316



Varenr.	Ø / F	D	L	DKK
Fi21-1	19mm	42	65	53,20
Fi21-2	25mm	42	65	53,20
Fi21-3	3/4"	70	130	93,90
Fi21-4	1"	70	130	96,95

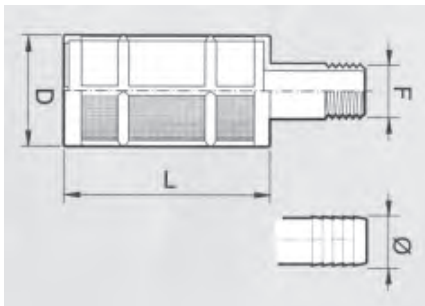

Filter 16 mesh

PA (POLYAMID) / AISI 316 - BSPT



Varenr.	F	h	D	L	DKK
Fi20-1	1 1/4"	16	88	120	130,75
Fi20-2	1 1/4"	16	110	130	136,75
Fi20-3	1 1/2"	20	110	200	182,00
Fi20-4	2"	16	110	200	185,25

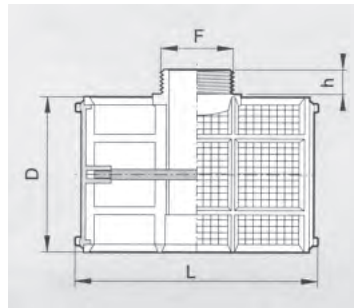

Filter

PP (POLYPROPYLEN)



Varenr.	Ø	diam.	DKK
Fi5-1	19	60	32,95
Fi5-2	19	60	56,25 ^α
Fi5-3	15	100	27,85
Fi5-4	20	100	27,85
Fi5-5	22	100	27,85
Fi5-6	25	100	27,85
Fi5-7	25	125	36,05
Fi5-8	30	125	36,05
Fi5-9	30	150	56,00
Fi5-10	35	150	56,00
Fi5-11	40	150	56,00
Fi5-12	50	150	56,00
Fi5-13	1 1/4"	150	60,35

^α = indbygget ventil

Filter

PA (POLYAMID) / AISI 316



Varenr.	Ø	diam.	DKK
Fi6-1	17	100	182,00
Fi6-2	23	100	182,00
Fi6-3	25 - 30	100	265,25
Fi6-4	35 - 40	100	300,75
Fi6-5	50	120	300,75

VENTILER



726 KUGLEHANER
RUSTFRI AISI 316



730 VENTILER
RUSTFRI AISI 316



734 KUGLEHANER
MESSING



740 VENTILER
MESSING



744 VENTILER
MESSING MINI



747 VENTILER PLAST



750 VENTILER PVC



756 VENTILER PP



760 KONTRAVENTILER
RUSTFRI



766 KONTRAVENTILER
MESSING



769 KONTRAVENTILER
PLAST



773 SIKKERHEDSVENTILER



774 MAGNETVENTILER



778 LUFTSTYRINGSVENTILER



784 KUGLEHANER PNEUMA-
TISKE RUSTFRI AISI 316



785 KUGLEHANER EL-STYREDE
RUSTFRI AISI 316



788 PNEUMATVENTILER
SKRÅ RUSTFRI AISI 316



790 PNEUMATVENTILER
LIGE RUSTFRI AISI 316

KUGLEHANER RUSTFRI AISI 316



40, 55 og 63 bar,
se specifikationer



-20° til +180°C



DIN 1.4408



Serie af rustfrie kuglehaner med et bredt spektrum af varianter og dimensioner.

Selv om der kan forekomme leverancer med lås på håndtaget, er dette IKKE standard, med mindre der er tale om LOCK modeller.

Endvidere er det normalt, at der er blå håndtag på kuglehanerne, men gule kan forekomme.

GENERELT:

1. Max arbejdstryk er varierende alt efter model, dimension, temp. Se på den specifikke model. *Ovenstående information er trykt på ventilerne.*
2. Enhver kuglebane virker som et trykkammer på en given installation, personale der installere eller vedligeholder sådanne installationer, skal overholde sikkerhedsregler og tage nødvendige forholdsregler overfor mulige skader.

BEGRÆNSNING:

Ventilerne må ikke bruges i sikkerhedszoner, så som sikkerhedssløjfer eller til uforenelige væsker. Ventilerne er kun til åbne eller lukke funktioner (kan ikke bruges som drøvle ventiler). For bedste service, skal ventilerne kun stilles i fuld åben eller fuld lukket funktion under brug.

LAGRING:

For bedste lagring gør følgende:

Ventilerne efterlades i fuld åben stand - de leveres fra ROYKON AS i denne stand. Ventilerne skal lagres beskyttet for støv og i et tørt miljø.

INSTALLATION:

Inden installation tjekkes ventilen samt rørstrækningen for eventuelt snavs. Kontrollér altid funktionen af ventiler inden installation (2 gange lukke åbne). Installér ventilerne på en måde så udvidelse af rørstrækning ikke påvirker ventilen.

VEDLIGHOLDELSE:

Sørg altid for at udløse al tryk på strækningen, tjek altid ved at åbne ventilen langsomt og mindst muligt. Det er umuligt, at sige hvor regelmæssig rørstrækninger skal kontrolleres, idet det afhænger af mange faktorer.

Det vigtigste er at holde personel uden skader, samt forhindre skader på materialer.

Kuglehane 2-delt

AISI 316 - BSPP - FULD GENNEMLØB



Varenr.	BSPP	BAR	DKK
B33-2	1/4"	63	227,75
B33-3	3/8"	63	187,25
B33-4	1/2"	63	196,25
B33-5	3/4"	63	261,50
B33-6	1"	63	395,25
B33-7	1 1/4"	63	618,50
B33-8	1 1/2"	63	865,75
B33-9	2"	63	1152,75
B33-10	2 1/2"	40	2705,00
B33-11	3"	40	3883,25
B33-12	4"	25	7435,75

Kuglehane 2-delt låsbar

AISI 316 - BSPP - FULD GENNEMLØB



Varenr.	BSPP	DKK
B33-2-L	1/4"	227,75
B33-3-L	3/8"	187,25
B33-4-L	1/2"	196,25
B33-5-L	3/4"	261,50
B33-6-L	1"	395,25
B33-7-L	1 1/4"	618,50
B33-8-L	1 1/2"	865,75
B33-9-L	2"	1152,75
B33-10-L	2 1/2"	2705,00
B33-11-L	3"	3883,25

Kuglehane muf/muf

AISI 316 - BSPP - REDUCERET GENNEMLØB



Varenr.	BSPP	BAR	DKK
B32-2	1/4"	40	153,25
B32-3	3/8"	40	159,25
B32-4	1/2"	40	184,00
B32-5	3/4"	40	236,00
B32-6	1"	40	299,50
B32-7	1 1/4"	40	400,50
B32-8	1 1/2"	40	521,50
B32-9	2"	40	806,75

Kuglehane nip/muf 2-delt

AISI 316 - BSPT×BSPP - FULD GENNEMLØB



Varenr.	BSPT×BSPP	BAR	DKK
B33N-2	1/4"	63	230,00
B33N-3	3/8"	63	189,50
B33N-4	1/2"	63	198,50
B33N-5	3/4"	63	264,25
B33N-6	1"	63	399,00
B33N-7	1 1/4"	63	624,25
B33N-8	1 1/2"	63	694,00
B33N-9	2"	63	1165,00

Kuglehane nip/muf

AISI 316 - BSPT×BSPP - RED. GENNEMLØB



Varenr.	BSPT×BSPP	BAR	DKK
B32A-2	1/4"	40	153,25
B32A-3	3/8"	40	159,25
B32A-4	1/2"	40	184,00
B32A-5	3/4"	40	236,00
B32A-6	1"	40	299,50

Kuglehane 2-delt med T-greb

AISI 316 - BSPP - FULD GENNEMLØB



Varenr.	BSPP	BAR	DKK
B33B-2	1/4"	63	219,75
B33B-3	3/8"	63	230,00
B33B-4	1/2"	63	260,50
B33B-5	3/4"	63	335,75
B33B-6	1"	63	479,25

Kuglehane højtryk muffe/ muffe



AISI 316
100bar max. -20° til +140°C.
Til vand og damp.
EPDM O-ring, PTFE tætning.

Varenr.	BSPP	DKK
BH33-1	1/8"	1391,75
BH33-2	1/4"	1391,75
BH33-3	3/8"	1425,75
BH33-4	1/2"	1537,00
BH33-5	3/4"	3121,00
BH33-6	1"	3417,75
BH33-7	1 1/4"	6198,75
BH33-8	1 1/2"	8044,50
BH33-9	2"	9677,00

Kuglehane højtryk muffe/ muffe

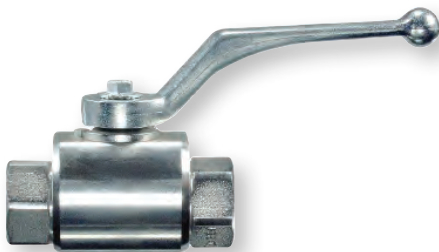

AISI 316
500bar max. -20° til +100°C.
Til hydraulik.
NBR O-ring, POM tætning.

Varenr.	BSPP	DKK
BH33-1-1	1/8"	1391,75
BH33-2-1	1/4"	1391,75
BH33-3-1	3/8"	1425,75
BH33-4-1	1/2"	1537,00
BH33-5-1	3/4"	3121,00
BH33-6-1	1"	3417,75
BH33-7-1	1 1/4"	6198,75
BH33-8-1	1 1/2"	8044,50
BH33-9-1	2"	9677,00

Kuglehane 2-delt med ISO top

AISI 316 - BSPP - FULD GENNEMLØB



Varenr.	BSPP	BAR	Top	DKK
B33M-2	1/4"	63	9	347,00
B33M-3	3/8"	63	9	347,00
B33M-4	1/2"	63	9	410,50
B33M-5	3/4"	63	9	501,75
B33M-6	1"	63	9	717,75
B33M-7	1 1/4"	63	9	934,50
B33M-8	1 1/2"	63	14	1312,25
B33M-9	2"	63	14	1748,00

Kuglehane 3-delt med ISO top

AISI 316 - BSPP - FULD GENNEMLØB



Varenr.	BSPP	Top	DKK
B33-22-ISO	1/4"	9	432,25
B33-23-ISO	3/8"	9	432,25
B33-24-ISO	1/2"	9	432,25
B33-25-ISO	3/4"	9	560,25
B33-26-ISO	1"	9	731,25
B33-27-ISO	1 1/4"	9	1071,25
B33-28-ISO	1 1/2"	14	1398,75
B33-29-ISO	2"	14	2074,50
B33-20-ISO	2 1/2"	14	3577,25
B33-21-ISO	3"	14	4084,00

Kuglehane muf/muf

AISI 316 - BSPP



Varenr.	BSPP	BAR	DKK
B32C-2	1/4"	55	163,00
B32C-3	3/8"	55	170,00
B32C-4	1/2"	55	196,50
B32C-5	3/4"	55	224,25
B32C-6	1"	55	294,25

Kuglehane muf/nip

AISI 316 - BSPP



Varenr.	BSPP	BAR	DKK
B32B-2	1/4"	55	163,00
B32B-3	3/8"	55	170,00
B32B-4	1/2"	55	196,50
B32B-5	3/4"	55	224,25
B32B-6	1"	55	294,25

Aftapningshane m. studs

AISI 316 - BSPP



Varenr.	BSPP	DKK
B320-4	1/2"	231,25
B320-5	3/4"	258,25
B320-6	1"	382,00

Kuglehane 3-delt

AISI 316 - BSPP - FULD GENNEMLØB



Varenr.	BSPP	BAR	DKK
B33-22	1/4"	63	432,25
B33-23	3/8"	63	432,25
B33-24	1/2"	63	432,25
B33-25	3/4"	63	560,25
B33-26	1"	63	731,25
B33-27	1 1/4"	63	1071,25
B33-28	1 1/2"	63	1398,75
B33-29	2"	63	2074,50
B33-30	2 1/2"	40	3577,25

Kuglehane 3-vejs L

AISI 316 - BSPP



Varenr.	BSPP	BAR	DKK
B33-42	1/4"	63	991,00
B33-43	3/8"	63	991,00
B33-44	1/2"	63	1041,50
B33-45	3/4"	63	1279,50
B33-46	1"	63	1761,50
B33-47	1 1/4"	63	2349,50
B33-48	1 1/2"	63	2999,50
B33-49	2"	63	4674,25

Kuglehane 3-vejs L m. ISO top

AISI 316 - BSPP



Varenr.	BSPP	DKK
B33-42-ISO	1/4"	824,50
B33-43-ISO	3/8"	824,50
B33-44-ISO	1/2"	852,25
B33-45-ISO	3/4"	1169,25
B33-46-ISO	1"	1543,00
B33-47-ISO	1 1/4"	2200,25
B33-48-ISO	1 1/2"	2906,75
B33-49-ISO	2"	4276,75
B33-40-ISO	3"	α

L-BORET KUGLEHANE

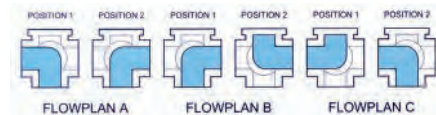

Kuglehane 3-delt svejs/svejs

AISI 316 - FULD GENNEMLØB



Varenr.	dim	BAR	DKK
B33-22/A	1/4" ~ 13,5	63	436,50
B33-23/A	3/8" ~ 17,2	63	436,50
B33-24/A	1/2" ~ 21,3	63	436,50
B33-25/A	3/4" ~ 26,9	63	565,50
B33-26/A	1" ~ 33,7	63	738,50
B33-27/A	1 1/4" ~ 42,4	63	1082,75
B33-28/A	1 1/2" ~ 48,3	63	1160,00
B33-29/A	2" ~ 60,3	63	1738,75
B33-30/A	2 1/2" ~ 76,1	40	3612,25

Kuglehane 3-vejs T

AISI 316 - BSPP



Varenr.	BSPP	BAR	DKK
B33-52	1/4"	63	1583,25
B33-53	3/8"	63	1630,50
B33-54	1/2"	63	1906,75
B33-55	3/4"	63	2168,25
B33-56	1"	63	2840,75
B33-57	1 1/4"	63	3983,25
B33-58	1 1/2"	63	5227,25
B33-59	2"	63	6605,50

Kuglehane 3-vejs T m. ISO top

AISI 316 - BSPP



Varenr.	BSPP	DKK
B33-52-ISO	1/4"	824,50
B33-53-ISO	3/8"	824,50
B33-54-ISO	1/2"	852,25
B33-55-ISO	3/4"	1169,25
B33-56-ISO	1"	1543,00
B33-57-ISO	1 1/4"	2200,25
B33-58-ISO	1 1/2"	2906,75
B33-59-ISO	2"	4276,75
B33-50-ISO	3"	α

T-BORET KUGLEHANE

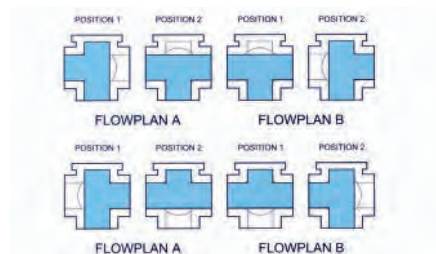

α = spørg på pris

VENTILER RUSTFRI AISI 316



Max. 63bar



-20° til +180°C



Serie af rustfri specialprodukter med et bredt spektrum af varianter og dimensioner. Nogle meget kraftigt bygget, der kan tåle meget høje tryk, nogle meget store typer og nogle, der ikke passer til andre kategorier.

Kuglehane stor 2-delt

AISI 316



Skydeventil m. DIN 2501 flanger

AISI 316



Varenr.	DN	BAR	DKK
B33sH-4	15	10	α
B33sH-5	20	10	α
B33sH-6	25	10	α
B33sH-7	32	10	α
B33sH-8	40	10	α
B33sH-9	50	10	α
B33sH-10	65	10	α
B33sH-11	80	10	α
B33sH-12	100	10	α
B33sH-13	125	10	16879,50
B33sH-14	150	10	α
B33sH-15	200	10	α
B33sH-16	250	10	α

α = spørg på pris

Varenr.	dim	BAR	DKK
B34sH-4	15	16	α
B34sH-5	20	16	α
B34sH-6	25	16	α
B34sH-7	32	16	α
B34sH-8	40	16	10471,00
B34sH-9	50	16	α
B34sH-10	65	16	15553,00
B34sH-11	80	16	18890,25
B34sH-12	100	16	25985,00
B34sH-13	125	16	32577,00
B34sH-14	150	16	43985,25
B34sH-15	200	16	66015,00
B34sH-16	250	16	α

α = spørg på pris



645

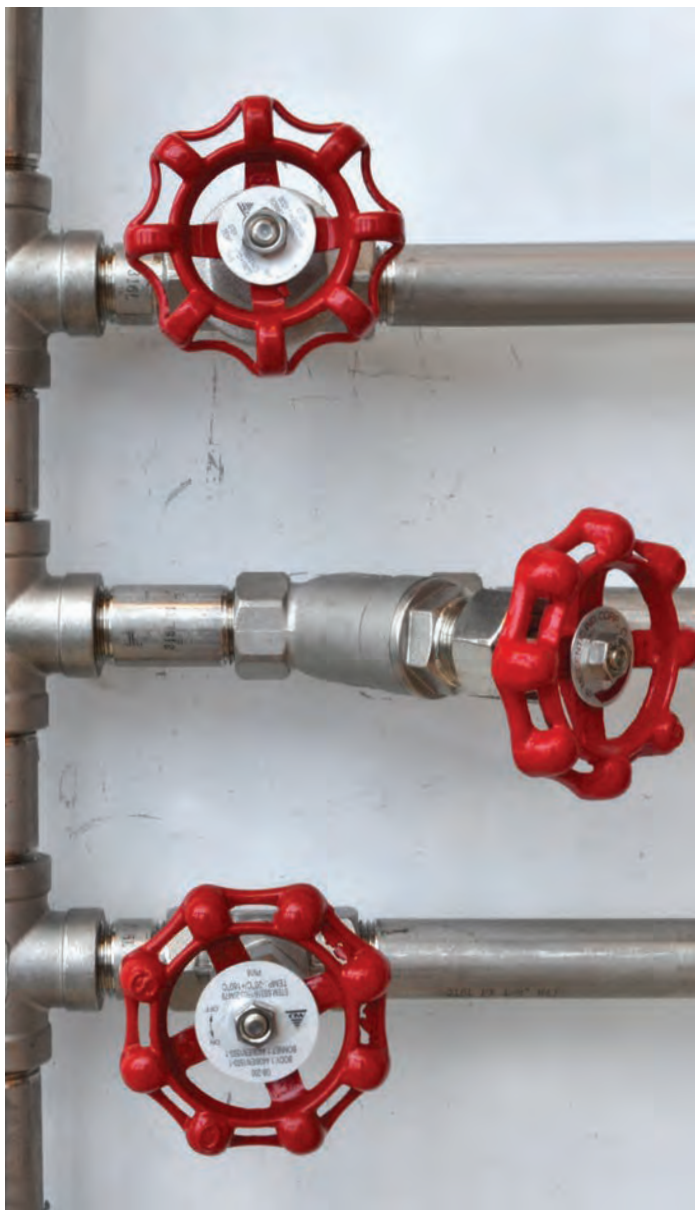

Skydeventil

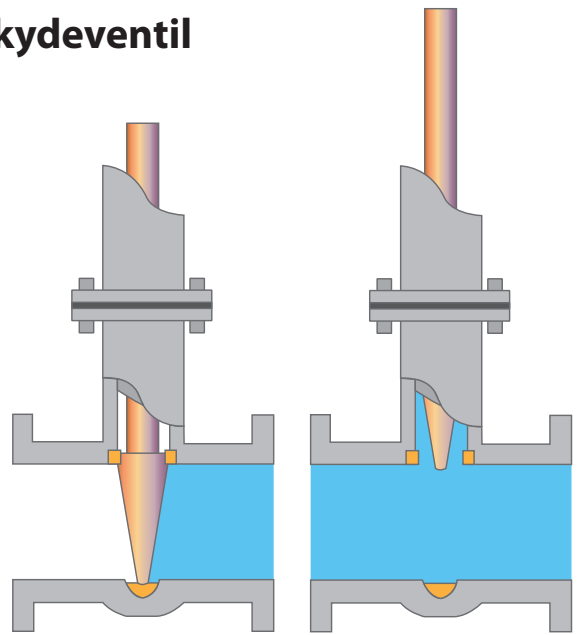

Sædeventil

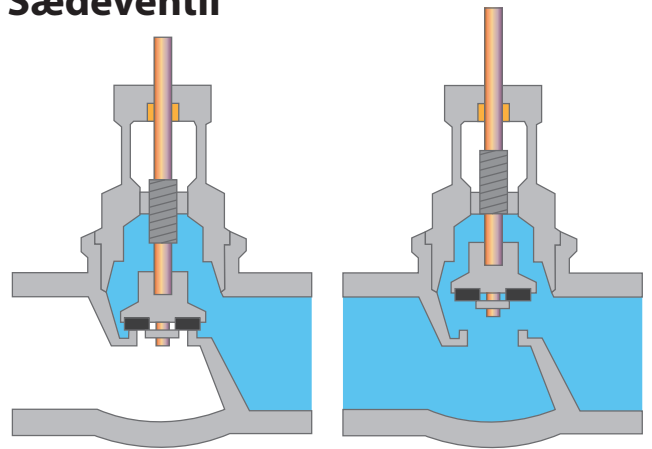

Skydeventil AISI 316 - BSPP



Varenr.	BSPP	DKK
B34-24	1/2"	805,50
B34-25	3/4"	991,00
B34-26	1"	1208,25
B34-27	1 1/4"	1535,75
B34-28	1 1/2"	2197,00
B34-29	2"	2701,75

Sædeventil AISI 316 - BSPP



Varenr.	BSPP	DKK
B34G-24	1/2"	805,50
B34G-25	3/4"	991,00
B34G-26	1"	1208,25
B34G-27	1 1/4"	1535,75
B34G-28	1 1/2"	2197,00
B34G-29	2"	2701,75

Sædeventil skrå AISI 316 - BSPP



Varenr.	BSPP	DKK
B34GV-24	1/2"	805,50
B34GV-25	3/4"	991,00
B34GV-26	1"	1208,25
B34GV-27	1 1/4"	1535,75
B34GV-28	1 1/2"	2197,00
B34GV-29	2"	2701,75

Luftskrue

AISI 316 - BSPT



Varenr.	BSPT	DKK
BL3-2	1/4"	126,50
BL3-4	1/2"	199,50

Metaltætning

Trykregulator -15° til +100°C

AISI 316 - BSPP



Varenr.	BSPP	25 bar	DKK
B3100-4	1/2"	1 - 6	2293,00
B3100-5	3/4"	1 - 6	2904,75
B3100-6	1"	1 - 6	3317,75

1/4" manometer tilslutning (GC2)

Nåleventil højtryk muffe/muffe

AISI 316 - BSPP



Max 345bar, -50° til +230°C		
Varenr.	BSPP	DKK
C146-2	1/4"	1331,50
C146-3	3/8"	1481,75
C146-4	1/2"	1814,50

Snavssamlere

AISI 316 - BSPP



Varenr.	BSPP	DKK
B34-2	1/4"	409,25
B34-3	3/8"	431,00
B34-4	1/2"	494,25
B34-5	3/4"	580,50
B34-6	1"	768,50
B34-7	1 1/4"	936,00
B34-8	1 1/2"	1349,50
B34-9	2"	1709,00
B34-10	2 1/2"	2472,00
B34-11	3"	3883,25

Nåleventil muf/muf højtryk

AISI 316 - BSPP



Varenr.	BSPP	DKK
B39H-1	1/8"	510,00
B39H-2	1/4"	510,00
B39H-3	3/8"	547,75
B39H-4	1/2"	743,75
B39H-5	3/4"	862,00
B39H-6	1"	2736,50

Max 200 bar

Nåleventil 90° højtryk muf/muf

AISI 316 - BSPP



Max 345bar, -50° til +230°C		
Varenr.	BSPP	DKK
C145-2	1/4"	1331,50
C145-3	3/8"	1481,75
C145-4	1/2"	1814,50

Filter til snavssamlere

AISI 316



Hulstørrelse = 1mm		
Varenr.	dim	DKK
B34F-2	1/4"	48,15
B34F-3	3/8"	52,40
B34F-4	1/2"	57,60
B34F-5	3/4"	63,05
B34F-6	1"	135,50
B34F-7	1 1/4"	172,50
B34F-8	1 1/2"	198,50
B34F-9	2"	379,00



462

ROYKON A/S

- EN ARBEJDSPLADS FOR MEDARBEJDERNE

Vi gør alt, for at have en god arbejdsplads med plads til alle.

Vi holder af vores medarbejdere og forsøger konstant at udvikle virksomheden.

Vi holder undervisning i vores produkter, således medarbejderne er fortrolige med dem.

Vi har medarbejdere på flextid, vi har medarbejdere på parttids barselsordning, vi har medarbejdere på halvdag, blot for at nævne nogle af dem.

Årlige traditioner som sommerfest og julefrokost er en del af virksomheden og en god måde at komme til at kende hinanden bedre på.

Vi har rigtig mange kunder, der har handlet hos os i mange år, som vi også følger i tykt og tyndt. Vi mener, motiverede medarbejdere gør en forskel i den daglige kontakt.

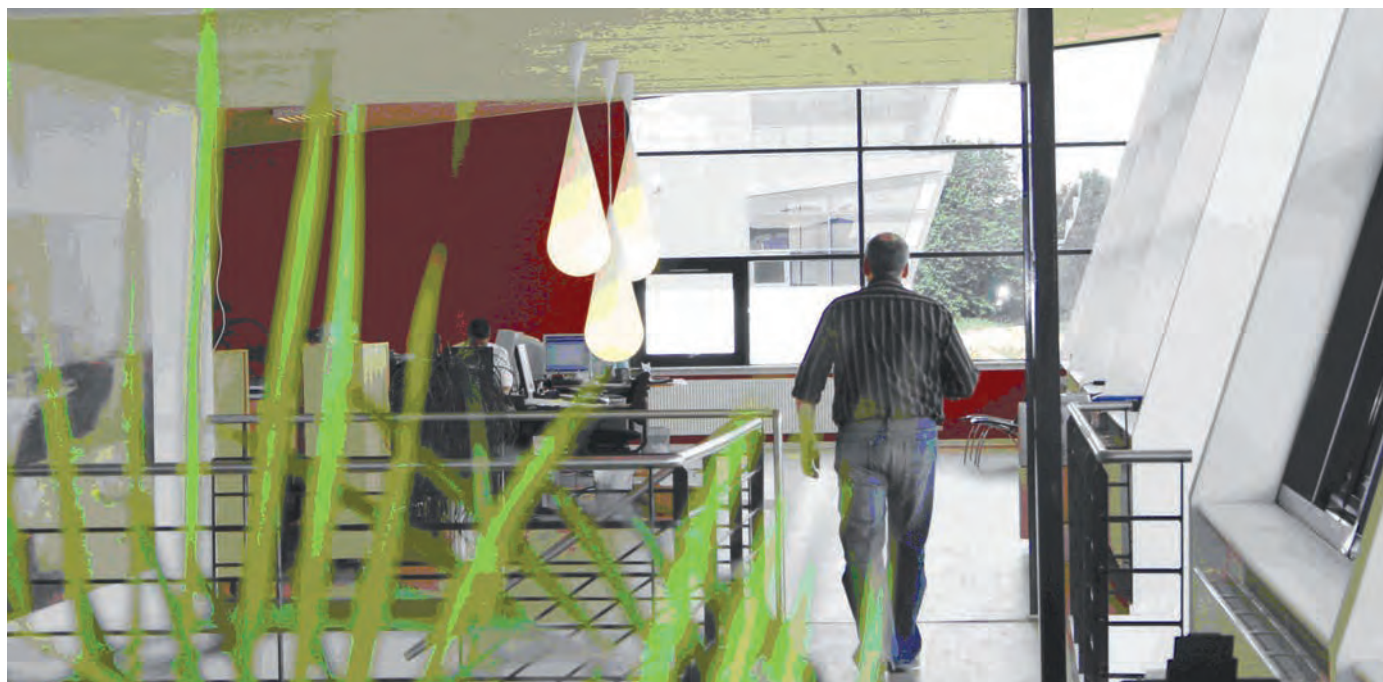

KUGLEHANER MESSING



25 bar ved 20°C



Se skema



Serie af messing kuglehaner med et bredt spektrum af varianter og dimensioner.



Kuglehane muf/muf FB

MESSING - BSPP



Varenr.	BSPP	DKK
E300-2	1/4"	98,25
E300-3	3/8"	98,25
E300-4	1/2"	98,25
E300-5	3/4"	140,50
E300-6	1"	199,25
E300-7	1 1/4"	324,00
E300-8	1 1/2"	477,00
E300-9	2"	679,75
E300-10	2 1/2"	1547,75
E300-11	3"	3008,25
E300-12	4"	3251,00

Kuglehane nip/muf FB

MESSING - BSPP



Varenr.	BSPP	DKK
E301-2	1/4"	107,25
E301-3	3/8"	107,25
E301-4	1/2"	107,25
E301-5	3/4"	149,00
E301-6	1"	212,25
E301-7	1 1/4"	349,75
E301-8	1 1/2"	499,50
E301-9	2"	708,50

Kuglehane nip/nip FB

MESSING - BSPP



Varenr.	BSPP	DKK
E302-3	3/8"	107,25
E302-4	1/2"	107,25
E302-5	3/4"	141,75
E302-6	1"	212,25
E302-7	1 1/4"	349,75
E302-8	1 1/2"	499,50
E302-9	2"	708,50

Håndtag

STÅL



Varenr.	dim	DKK
E2090-2/3/4/5	1/4" - 3/4"	5,80

Håndtag

ALUMINIUM



Varenr.	dim	DKK
E2091-2/3/4/5	1/4" - 3/4"	5,80
E2091-6	1"	10,15
E2091-7/8/9	1 1/4" - 2"	25,35

T-håndtag

ALUMINIUM



Varenr.	dim	DKK
E2092-2/3/4/5	1/4" - 3/4"	8,05
E2092-6	1"	8,10

Håndtag, flad

STÅL



Varenr.	dim	DKK
E2093-2/3/4/5	1/4" - 3/4"	5,80
E2093-6	1"	14,25
E2093-7/8/9	1 1/4" - 2"	25,35

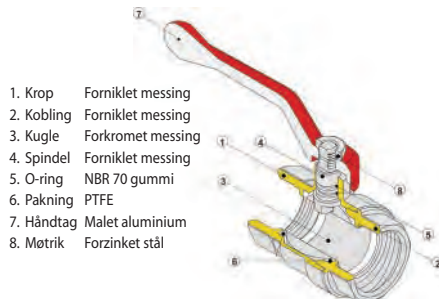
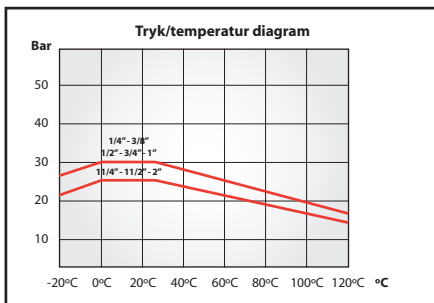

1. Krop Forniklet messing
2. Kobling Forniklet messing
3. Kugle Forkromet messing
4. Spindel Forniklet messing
5. O-ring NBR 70 gummi
6. Pakning PTFE
7. Håndtag Malet aluminium
8. Motrik Forzinket stål

Spindelforlænger

MESSING



Varenr.	dim	DKK
E2094-3/4	3/8" - 1/2"	123,75
E2094-5/6	3/4" - 1"	157,25
E2094-7/8/9	1 1/4" - 2"	171,00

Kuglehane muf/muf FB
MESSING - BSPP



Varenr.	BSPP	DKK
E300-2-1	1/4"	97,15
E300-3-1	3/8"	98,25
E300-4-1	1/2"	117,25
E300-5-1	3/4"	168,50
E300-6-1	1"	267,25

Kuglehane muf/muf FB
MESSING - BSPP

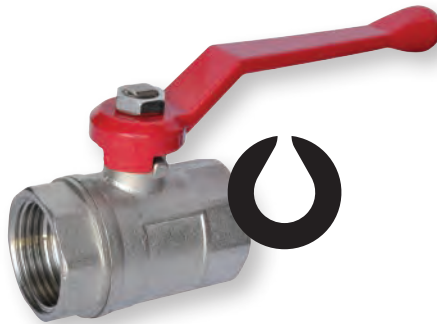

Varenr.	BSPP	DKK
418117703	3/8"	40,45
418117704	1/2"	38,20
418117706	3/4"	54,60
418117708	1"	110,25
418117710	1 1/4"	145,50
418117712	2"	374,25

Kuglehane muf/muf FB
MESSING - BSPP

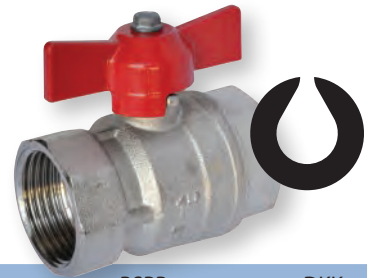

Varenr.	BSPP	DKK
418119703	3/8"	27,60
418119704	1/2"	34,30
418119706	3/4"	54,60
418119708	1"	110,25

Kuglehane nip/muf FB
MESSING - BSPP



Varenr.	BSPP	DKK
E301-2-1	1/4"	85,20
E301-3-1	3/8"	87,95
E301-4-1	1/2"	122,50
E301-5-1	3/4"	143,75
E301-6-1	1"	229,75

Kuglehane nip/muf FB
MESSING - BSPP



Varenr.	BSPP	DKK
418118702	1/4"	36,45
418118703	3/8"	27,60
418118704	1/2"	34,30
418118706	3/4"	54,60
418118708	1"	96,20

Kuglehane nip/muf FB
MESSING - BSPP



Varenr.	BSPP	DKK
418120703	3/8"	27,60
418120704	1/2"	57,75
418120706	3/4"	54,60
418120708	1"	116,00

Kuglehane nip/nip FB
MESSING - BSPP



Varenr.	BSPP	DKK
E302-3-1	3/8"	90,75
E302-4-1	1/2"	94,65
E302-5-1	3/4"	141,00
E302-6-1	1"	228,50

Kuglehane nip/nip FB
MESSING - BSPP



Varenr.	BSPP	DKK
EC302-4	1/2"	45,05
EC302-5	3/4"	62,35

Kuglehane FB
BRONZE / PTFE (TEFLON) - BSPP

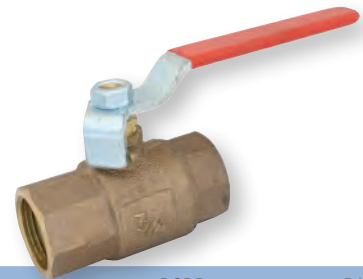

Varenr.	BSPP	DKK
EZ12-2	1/4"	353,25
EZ12-3	3/8"	356,25
EZ12-4	1/2"	361,00
EZ12-5	3/4"	461,75
EZ12-6	1"	705,75
EZ12-7	1 1/4"	1178,50
EZ12-8	1 1/2"	1452,50
EZ12-9	2"	2658,50
EZ12-10	2 1/2"	3473,25
EZ12-11	3"	6089,50
EZ12-12	4"	10439,25

Kuglehane 3-vejs L FB MESSING - BSPP



Varenr.	BSPP	DKK
EL300-3	3/8"	420,00
EL300-4	1/2"	770,00
EL300-5	3/4"	993,25
EL300-6	1"	1503,75
EL300-7	1 1/4"	1671,75
EL300-8	1 1/2"	1750,50
EL300-9	2"	4381,75

Kuglehane 3-vejs T FB MESSING - BSPP



Varenr.	BSPP	DKK
ET300-3	3/8"	770,00
ET300-4	1/2"	559,75
ET300-5	3/4"	722,75
ET300-6	1"	1070,00
ET300-7	1 1/4"	1980,50
ET300-8	1 1/2"	2333,25
ET300-9	2"	5267,00

Kuglehane 3-vejs L FB MESSING - BSPP



Bundtilslutning		
Varenr.	BSPP	DKK
E306-5	3/4"	175,75 ₺

₺ = så længe lager haves

Kuglehane 3-vejs T FB MESSING - BSPP



Bundtilslutning		
Varenr.	BSPP	DKK
E305-5	3/4"	175,75 ₺
E305-6	1"	225,00 ₺
E305-7	1 1/4"	359,75 ₺
E305-8	1 1/2"	466,25 ₺

₺ = så længe lager haves

Kuglehane muf/muf FB til gas MESSING - BSPP



Max. 4 bar. DG godkendelse nr. 3845

Varenr.	BSPP	DKK
E300G-4	1/2"	102,00
E300G-5	3/4"	144,25
E300G-6	1"	210,75
E300G-7	1 1/4"	339,00
E300G-8	1 1/2"	474,75
E300G-9	2"	728,00

Kuglehane nip/muf FB til gas MESSING - BSPT×BSPP



Max. 4 bar. DG godkendelse nr. 3845

Varenr.	BSPT×BSPP	DKK
E301G-4	1/2"	104,75
E301G-5	3/4"	148,00
E301G-6	1"	213,25
E301G-7	1 1/4"	348,25
E301G-8	1 1/2"	499,50
E301G-9	2"	766,50

Kuglehane muf/muf FB til gas MESSING - BSPP



Max. 4 bar. DG godkendelse nr. 3845

Varenr.	BSPP	DKK
E300GB-4	1/2"	98,85
E300GB-5	3/4"	141,75
E300GB-6	1"	206,75

Kuglehane muf/nip FB til gas MESSING - BSPP×BSPT



Max. 4 bar. DG godkendelse nr. 3845

Varenr.	BSPP×BSPT	DKK
E301GB-4	1/2"	102,50
E301GB-5	3/4"	145,25
E301GB-6	1"	261,75

Kuglehane muf/muf FB

MESSING - BSPP



Kan plomberes

Varenr.	BSPP	DKK
E300GP-4	1/2"	129,00
E300GP-5	3/4"	183,25
E300GP-6	1"	264,25
E300GP-7	1 1/4"	451,25
E300GP-8	1 1/2"	583,50
E300GP-9	2"	764,00

Kuglehane muf/nip FB

MESSING - BSPP×BSPT



Kan plomberes

Varenr.	BSPP × BSPT	DKK
E301GP-4	1/2"	131,25
E301GP-5	3/4"	186,50
E301GP-6	1"	268,50
E301GP-7	1 1/4"	459,75
E301GP-8	1 1/2"	612,25
E301GP-9	2"	803,75

Mini kuglehane

MESSING - BSPP



Varenr.	BSPP	DKK
E310-1	1/8"	47,10
E310-2	1/4"	63,50
E310-3	3/8"	73,20
E310-4	1/2"	49,70
E310-5	3/4"	80,20

Mini kuglehane nip/muf

MESSING - BSPP



Varenr.	BSPP	DKK
E311-1	1/8"	47,10
E311-2	1/4"	64,30
E311-3	3/8"	64,30
E311-4	1/2"	65,10
E311-5	3/4"	80,20

Mini kuglehane nip/nip

MESSING - BSPT



Varenr.	BSPT	DKK
E312-1	1/8"	47,10
E312-2	1/4"	39,85
E312-3	3/8"	39,85
E312-4	1/2"	79,05
E312-5	3/4"	76,35

Mini kuglehane muf/muf

MESSING - BSPP



Varenr.	BSPP	DKK
EC310-5	3/4"	19,30 ₺

₺ = så længe lager haves

Mini kuglehane nip/muf

MESSING - BSPP



NB! Håndtag kan være rødt

Varenr.	BSPP	DKK
EC311-2	1/4"	11,30 ₺
EC311-4	1/2"	11,30 ₺
EC311-5	3/4"	21,05 ₺

₺ = så længe lager haves

Mini kuglehane nip/muf

MESSING - BSPP



Sort håndtag

Varenr.	BSPP	DKK
743523104s	1/2"	27,00

Mini kuglehane nip/muf

MESSING - BSPP



Godkendt til drikkevand

Varenr.	BSPP	DKK
743523104	1/2"	25,70

Mini kuglehane 90° nip/muf

MESSING - BSPP



Varenr.	BSPP	DKK
E311V-4	1/2"	163,50

Mini kuglehane muf/muf

MESSING - BSPP



Varenr.	BSPP	DKK
E310A-3	3/8"	32,15 ₺
E310A-4	1/2"	38,05 ₺

₺ = så længe lager haves

Mini kuglehane nip/muf

MESSING - BSPP



Varenr.	BSPP	DKK
E311A-2	1/4"	35,30 ₺
E311A-3	3/8"	35,30 ₺

₺ = så længe lager haves

Mini kuglehane nip/nip

MESSING - BSPP

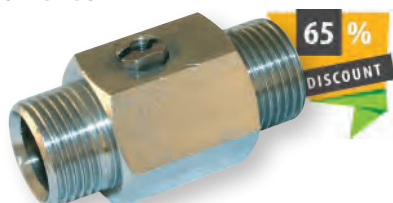

Varenr.	BSPP	DKK
E312A-3	3/8"	37,90 ₺
E312A-4	1/2"	40,35 ₺

₺ = så længe lager haves

Aftapningshane nip/nip

MESSING - BSPP



Varenr.	BSPP	DKK
E325-4	1/2"	79,05

Aftapningshane nip/studs

MESSING - BSPP



Varenr.	BSPP	DKK
E325B-4	1/2"	156,25

Aftapningshane m. studs

MESSING - BSPP



Varenr.	BSPP	DKK
E320-4	1/2"	98,85
E320-5	3/4"	112,50
E320-6	1"	214,25

Aftapningshane nip/studs

MESSING - BSPP



Låsbar		
Varenr.	BSPP	DKK
E330-4	1/2"	139,50

Kuglehane m. aftapning

MESSING - BSPP

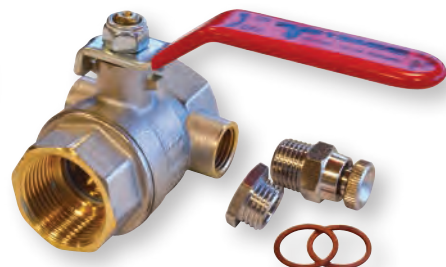

Inkl. 1/4" prop, aftapventil og pakninger.

Varenr.	BSPP	DKK
ET2980-4	1/2"	151,75
ET2980-5	3/4"	186,50
ET2980-6	1"	272,00
ET2980-7	1 1/4"	270,50
ET2980-8	1 1/2"	610,25
ET2980-9	2"	945,00

VENTILER MESSING



Serie af messingventiler med et bredt spektrum af varianter og dimensioner.



Aftapningshane nip/studs MESSING - BSPP



Varenr.	BSPP	DKK
E341-4	1/2"	166,25
E341-5	3/4"	243,00
E341-6	1"	385,25

Aftapningshane nip/studs MESSING - BSPP



Varenr.	BSPP	DKK
E342-4	1/2"	166,25
E342-5	3/4"	243,00
E342-6	1"	385,25

Udluftningsventil MESSING - BSPT



Udluftning i toppen		
Varenr.	BSPT	DKK
EL1-1	1/8"	15,75 α
EL1-2	1/4"	16,30 α
EL1-3	3/8"	30,40 α
EL1-4	1/2"	34,00

α = så længe lager haves

Udluftningsventil

MESSING/NYLON - BSPT



O-ring: NBR
Pakning: PTFE

Udluftning i toppen

Varenr.	BSPT	DKK
EL2-1	1/8"	13,20
EL2-2	1/4"	15,20
EL2-3	3/8"	28,35
EL2-4	1/2"	30,45

Indbygningsventil

MESSING - BSPP



Varenr.	dim	DKK
E2961-4	1/2"	253,25
E2961-5	3/4"	308,00

Med håndtag

Indbygningsventil

MESSING - BSPP



Varenr.	dim	DKK
E2963-4	1/2"	268,50
E2963-5	3/4"	321,25

Med håndtag

Sædeventil 90° nip/nip

MESSING - BSPP



Varenr.	BSPP	DKK
ET3997-4	1/2"	80,20

Kuglehane 90° m. filter

MESSING - BSPP



Varenr.	BSPP	DKK
ET2949-4	1/2"	130,00

Kuglehane 90° t. vaskemaskine

MESSING - BSPP



Varenr.	BSPP	DKK
ET2953-4	1/2" x 1/2"	104,00
ET2953-5	1/2" x 3/4"	104,00

Kuglehane "brand" nip/studs

MESSING - BSPP



Varenr.	BSPP	DKK
ET2970-4	1/2"	188,75
ET2970-5	3/4"	240,50

Kuglehane nippel/studs

MESSING - BSPP



Til kedelaftapning

Varenr.	BSPP	DKK
ET2990-3	3/8"	98,85
ET2990-4	1/2"	102,25

Skydeventil muf/muf

MESSING - BSPP



Varenr.	BSPP	DKK
410082004	1/2"	105,00
410082006	3/4"	115,25
410082008	1"	171,00
410082010	1 1/4"	268,50
410082011	1 1/2"	339,00
410082012	2"	522,00
410082013	2 1/2"	567,00
410082014	3"	1060,50
410082016	4"	1235,00

Filter

AISI 304 / PA (POLYAMID) - BSPT



Varenr.	Dim	DKK
E370-4	1/2"	25,60
E370-5	3/4"	29,25
E370-6	1"	31,30
E370-7	1 1/4"	28,35
E370-8	1 1/2"	34,15
E370-9	2"	45,90
E370-10	2 1/2"	101,25
E370-11	3"	126,50
E370-12	4"	200,50

Ligeløbsfilter muf/muf

MESSING - BSPP



Inkl. 800 micron AISI 304 filter

Varenr.	BSPP	DKK
449117803	3/8"	225,00
449117804	1/2"	204,00
449117806	3/4"	265,00
449117808	1"	384,50
449117810	1 1/4"	719,00
449117811	1 1/2"	1106,75
449117812	2"	1243,00

Ligeløbsfilter muf/nip

MESSING - BSPP×BSPT



Inkl. 800 micron AISI 304 filter

Varenr.	BSPP×BSPT	DKK
449118804	1/2"	204,00
449118806	3/4"	265,00
449118808	1"	384,50
449118810	1 1/4"	651,50
449118811	1 1/2"	1106,75
449118812	2"	1496,25

Dæksel til ligeløbsfilter

MESSING

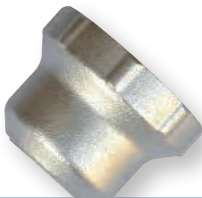

Varenr.	BSPP	DKK
E409-4	3/8" + 1/2"	105,00
E409-5	3/4"	136,25
E409-6	1"	180,75
E409-7	1 1/4"	265,25
E409-9	1 1/2" + 2"	404,50

Filter til ligeløbsfilter

AISI 304

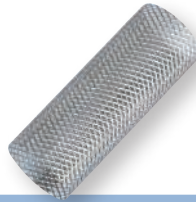

Varenr.	Str.	Micron	DKK
E408-50-4	3/8 - 1/2"	50	81,40
E408-50-5	3/4"	50	81,40
E408-50-6	1"	50	92,25
E408-50-7	1 1/4"	50	104,75
E408-50-9	1 1/2 - 2"	50	175,50
E408-100-4	3/8 - 1/2"	100	81,40
E408-100-5	3/4"	100	81,40
E408-100-6	1"	100	92,25
E408-100-7	1 1/4"	100	104,75
E408-100-9	1 1/2 - 2"	100	175,50
E408-300-4	3/8 - 1/2"	300	81,40
E408-300-5	3/4"	300	81,40
E408-300-6	1"	300	92,25
E408-300-7	1 1/4"	300	104,75
E408-300-9	1 1/2 - 2"	300	175,50
E408-800-4	3/8 - 1/2"	800	81,40
E408-800-5	3/4"	800	81,40
E408-800-6	1"	800	92,25
E408-800-7	1 1/4"	800	104,75
E408-800-9	1 1/2 - 2"	800	175,50

ET1900 serien:

- Krop: forniklet MS
- Flyder: PE
- O-ring: NBR
- Max arb.temp: 110°C
- Max udluftningstryk: 6bar
- Gevind: DIN EN ISO228 og BS EN ISO288

Automatisk udluftning

MESSING - BSPP



Varenr.	BSPP	Max bar	DKK
ET1900-3	3/8"	10	89,05
ET1900-4	1/2"	10	93,80
ET1900-5	3/4"	10	115,50
ET1900-6	1"	10	118,75

Automatisk udluftning

MESSING - BSPP



Varenr.	BSPP	Max bar	DKK
ET1902-3	3/8"	10	75,75
ET1902-4	1/2"	10	75,75

Automatisk udluftning

MESSING - BSPP



Varenr.	BSPP	Max bar	DKK
ET1903-3	3/8"	10	81,55
ET1903-4	1/2"	10	82,95

Automatisk udluftning

MESSING - BSPP



Varenr.	BSPP	Max bar	DKK
ET1904-3	3/8"	10	93,80
ET1904-4	1/2"	10	97,40

Automatisk udluftning

MESSING - BSPP



Varenr.	BSPP	Max bar	DKK
ET1905-3	3/8"	10	82,40
ET1905-4	1/2"	10	82,40

Lukkehane

MESSING - BSPP



Varenr.	BSPP	DKK
ET1901-3	3/8"	29,25
ET1901-4	1/2"	21,45

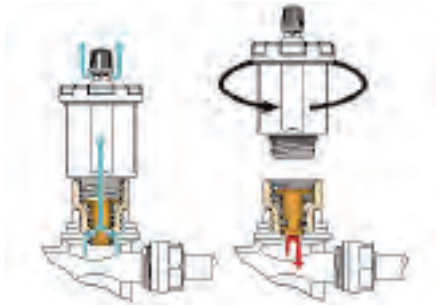

Trykregulator

MESSING - BSPP



Varenr.	BSPP	15 bar	DKK
E3100-3	3/8"	1 - 4	619,50
E3100-4	1/2"	1 - 4	528,25
E3100-5	3/4"	1 - 4	590,50

1/4" manometer tilslutning (GC2)

Trykregulator

MESSING - BSPP



Varenr.	BSPP	25 bar	DKK
E3107-4	1/2"	1 - 6	806,00
E3107-5	3/4"	1 - 6	1086,75
E3107-6	1"	1 - 6	1214,00
E3107-7	1 1/4"	1 - 6	2593,50
E3107-8	1 1/2"	1 - 6	2698,50
E3107-9	2"	1 - 6	3973,00

1/4" manometer tilslutning (GC8)

Nåleventil muf/muf max 100bar

MESSING - BSPP



Varenr.	BSPP	DKK
E5100-8-1/8	1/8"	235,50
E5100-8-1/4	1/4"	96,05
E5100-8-3/8	3/8"	143,25
E5100-8-1/2	1/2"	372,75
E5100-8-3/4	3/4"	443,25

Nåleventil muf/nip max 10bar

MESSING - BSPT×BSPP



Varenr.	BSPT × BSPP	DKK
E5100-88-1/4	1/4"	108,75
E5100-88-3/8	3/8"	143,25

Nåleventil muf/nip max 10bar

MESSING - BSPT×BSPP



Varenr.	BSPT × BSPP	DKK
E5100-89-3/8	3/8"	143,25

Snavssamler

MESSING - BSPP



Varenr.	BSPP	DKK
E400-4	1/2"	84,90
E400-5	3/4"	116,50
E400-6	1"	226,75
E400-7	1 1/4"	292,50
E400-8	1 1/2"	370,50
E400-9	2"	594,25
E400-10	2 1/2"	1440,75
E400-11	3"	2066,50
E400-12	4"	3819,00

Glideventil muf/muf

MESSING - BSPP



Varenr.	BSPP	DKK
E6060-1	1/8"	134,50
E6060-2	1/4"	166,25
E6060-3	3/8"	203,25
E6060-4	1/2"	256,25

-20° til +80°C. Min 0,3 bar, max 10

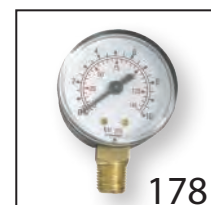
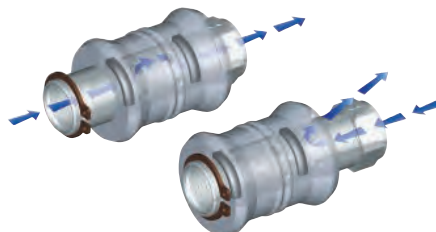

VENTILER MESSING MINI



Max 20bar



-18°C til +80°C



Serie af messing mini ventiler med et bredt spektrum af varianter og dimensioner.

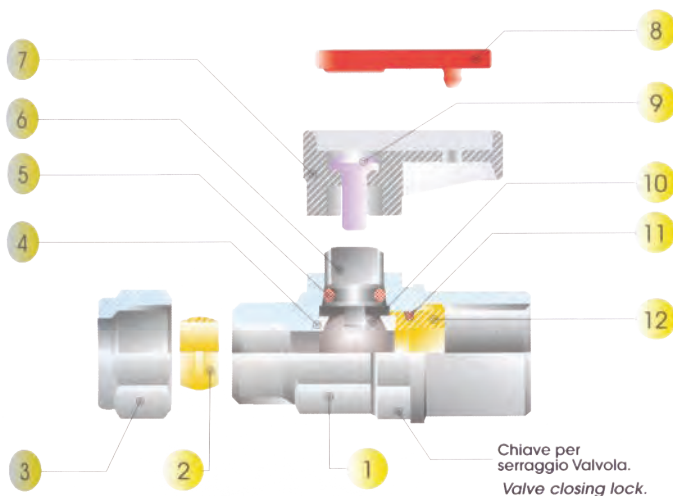

1. Forniklet messing krop
2. Messing skærering
3. Forniklet messing omløber
4. PTFE tætning
5. NBR shore 70 O-ring
6. Forniklet messing spindel
7. PA66 nylon håndtag
8. PA6 nylon plade i håndtag
9. Stålskive i håndtag
10. Krombehandlet messing kugle
11. NBR shore 70 O-ring tætning
12. Messing kugleholder

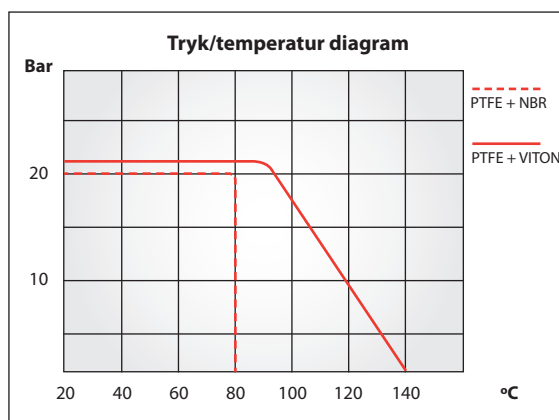
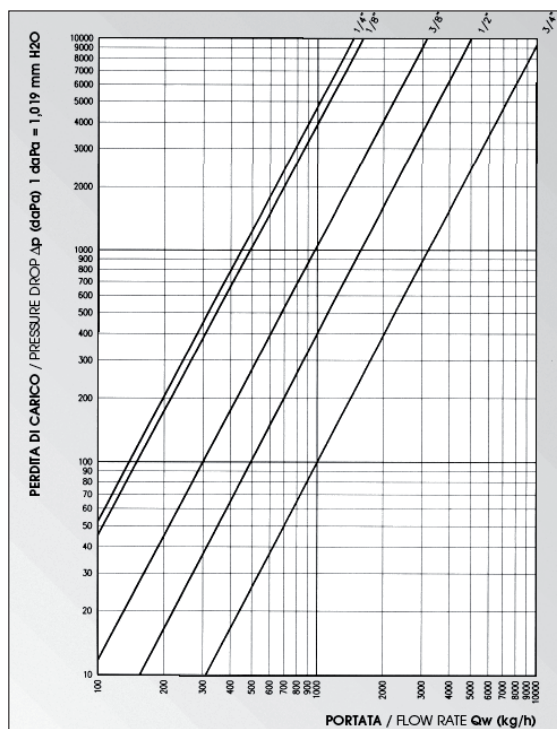

Mini kuglehane muf/muf

MESSING - BSPP



Varenr.	BSPP	L	DKK
E6400-1	1/8"	33,5mm	75,40
E6400-4	1/4"	38mm	74,90
E6400-5	3/8"	41,5mm	79,60
E6400-6	1/2"	49mm	98,25
E6400-7	3/4"	55,5mm	97,00

Mini kuglehane muf/muf

MESSING - BSPP



E6600 aflastningsventilen kan bruges til at aflaste manometre. Ved åben ventil er der tryk op til manometret og ved lukket ventil aflastes trykket ud af bagsiden på ventilen.

Med udluftning

Varenr.	BSPP	DKK
E6600-1	1/8"	107,00
E6600-2	1/4"	107,00
E6600-3	3/8"	116,25

Mini kuglehane nip/muf

MESSING - BSPP



Varenr.	BSPP	L	DKK
E6410-1	1/8"	34mm	76,00
E6410-2	1/4" × 1/8"	35mm	76,00
E6410-3	1/4"	35mm	78,20
E6410-4	3/8"	39mm	81,00
E6410-5	1/2"	45mm	103,75
E6410-6	3/4"	52mm	134,50

Mini kuglehane nip/muf

MESSING - BSPT×BSPP



Varenr.	BSPT × BSPP	DKK
E6310-1	1/8"	78,20
E6310-2	1/4" × 1/8"	78,75
E6310-3	1/4"	80,70
E6310-4	3/8"	84,35
E6310-5	1/2"	108,00
E6310-6	3/4"	140,50

Mini kuglehane nip/nip

MESSING - BSPT×BSPP



Varenr.	BSPT × BSPP	L	DKK
E6330-1	1/8"	35mm	76,00
E6330-2	1/4"	37mm	78,20
E6330-3	3/8"	42mm	81,55
E6330-4	1/2"	49mm	103,75
E6330-5	3/4"	58mm	137,25

Mini kuglehane nip/nip

MESSING - BSPP



Varenr.	BSPP	L	DKK
E6420-1	1/8"	32mm	75,15
E6420-2	1/8" × 1/4"	32mm	75,15
E6420-3	1/4"	33mm	75,15
E6420-4	3/8" × 1/4"	33mm	75,15
E6420-5	3/8"	37mm	78,20
E6420-6	1/2" × 3/8"	37mm	80,20
E6420-7	1/2"	42mm	97,40
E6420-8	3/4" × 1/2"	42mm	100,25
E6420-9	3/4"	49mm	128,50

Mini kuglehane nip/skær

MESSING - BSPT



Varenr.	ø × BSPT	L	DKK
E6350-1	6 × 1/8"	40,5mm	84,90
E6350-2	8 × 1/8"	41,5mm	86,30
E6350-3	6 × 1/4"	46mm	85,45
E6350-4	8 × 1/4"	45mm	86,30
E6350-5	10 × 3/8"	50,5mm	92,95
E6350-6	12 × 3/8"	51,5mm	94,35
E6350-7	14 × 1/2"	59,5mm	120,75
E6350-8	15 × 1/2"	59,5mm	120,75
E6350-9	16 × 3/4"	67mm	158,75
E6350-10	18 × 3/4"	67mm	158,75

Mini kuglehane skær/skær

MESSING



Varenr.	ø	L	DKK
E6450-1	6	46mm	95,75
E6450-2	6 × 8	48mm	96,55
E6450-3	8	48mm	98,50
E6450-4	10 × 8	51mm	100,75
E6450-5	10	55mm	104,25
E6450-6	10 × 12	56mm	105,75
E6450-7	12	57mm	107,25
E6450-8	14 × 10	59,5mm	114,25
E6450-9	14 × 12	60,5mm	114,25
E6450-12	14	63mm	139,50
E6450-10	15 × 10	59,5mm	112,75
E6450-11	15 × 12	60,5mm	114,25
E6450-13	15 × 14	63mm	139,50
E6450-14	15	63mm	139,50
E6450-15	16 × 14	68mm	151,75
E6450-16	16 × 15	68mm	151,75
E6450-17	18 × 14	68mm	151,75
E6450-18	18 × 15	68mm	151,75
E6450-19	18 × 16	71mm	187,50
E6450-20	18	71mm	187,50

Mini kuglehane skær/skær

MESSING



Med vægbeslag

Varenr.	ø	DKK
E6500-1	8	141,75

Mini kuglehane 90°

MESSING



Skæring/skæring

Varenr.	ø	DKK
E6550-1	8	148,00

Mini push-in kuglehane muf/muf

MESSING



Varenr.	ø	DKK
E6560-1	4	73,50
E6560-2	6	77,70
E6560-3	8	81,65
E6560-4	10	83,75
E6560-5	12	95,55

Mini push-in kuglehane nip/muf

MESSING



Varenr.	BSPT	ø	DKK
E6570-1	1/8"	4	58,30
E6570-2	1/8"	6	60,40
E6570-3	1/8"	8	62,35
E6570-4	1/4"	6	61,45
E6570-5	1/4"	8	63,55

Håndtag kort



Varenr.	dim	DKK
E6900-1	1/8" - 3/8"	2,63
E6900-2	1/2" - 3/4"	2,94

Håndtag lang



Varenr.	dim	DKK
E6910-1	1/8" - 3/8"	2,94
E6910-2	1/2" - 3/4"	4,15

Håndtagsindlæg



Varenr.	dim	Farve	DKK
E6920-1	1/8" - 3/8"	rød/red	2,07
E6920-2	1/8" - 3/8"	gul/yellow	2,07
E6920-3	1/8" - 3/8"	blå/blue	2,07
E6920-4	1/8" - 3/8"	hvid/white	2,07
E6920-5	1/8" - 3/8"	grøn/green	2,07
E6920-6	1/2" - 3/4"	rød/red	2,07
E6920-7	1/2" - 3/4"	gul/yellow	2,07
E6920-8	1/2" - 3/4"	blå/blue	2,07
E6920-9	1/2" - 3/4"	hvid/white	2,07
E6920-10	1/2" - 3/4"	grøn/green	2,07

Spindelforlænger

MESSING



Varenr.	dim	L	DKK
E6915-1	1/8-1/4"	+ 58mm	40,70
E6915-3	3/8"	+ 59mm	32,75
E6915-4	1/2"	+ 68mm	47,65
E6915-5	3/4"	+ 70mm	52,45

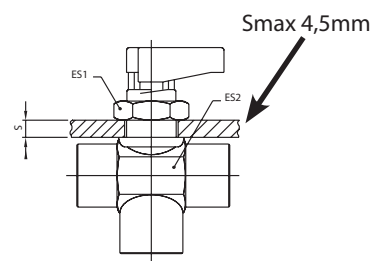

Mini kuglehane 90°

MESSING - BSPP



Til panelmontering

Varenr.	BSPP	L	DKK
E6720-1	1/8"	35mm	175,75
E6720-2	1/4"	37mm	180,50
E6720-3	3/8"	42mm	198,25

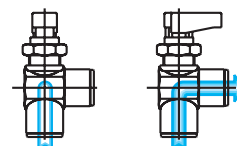

Mini kuglehane 3-vejs L

MESSING - BSPP



Til panelmontering

Varenr.	BSPP	L	DKK
E6700-1	1/8"	35mm	175,75
E6700-2	1/4"	37mm	180,50
E6700-3	3/8"	42mm	198,25

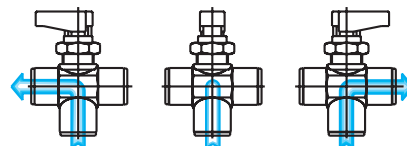

Mini kuglehane 3-vejs T

MESSING - BSPP



Til panelmontering

Varenr.	BSPP	L	DKK
E6710-1	1/8"	35mm	175,75
E6710-2	1/4"	37mm	180,50
E6710-3	3/8"	42mm	198,25

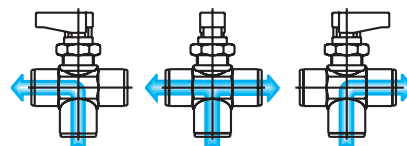

VENTILER PLAST



Forskellige typer af plastventiler.

Kuglehane nip/muf

POM (ACETAL) - BSPP



Varenr.	BSPP	DKK
A29-1	1/4"	90,10

Ventil

PE (POLYETHYLEN)



Varenr.	Ø	Lysning	DKK
A30-10	5-7	4	189,50
A30-11	7-9	6	219,50
A30-12	9-11	8	250,50
A30-13	11-13	8	250,50

3-vejs ventil

PE (POLYETHYLEN)



Både L og T boret

Varenr.	Ø	Lysning	DKK
A30-30	5-7	4	314,00
A30-31	7-9	6	373,25
A30-32	9-11	8	437,75
A30-33	11-13	8	437,75

3-vejs ventil

PP (POLYPROPYLEN) - BSPP



Varenr.	3 × BSPP	Bund	DKK
A30-50	1/8"	1/4"	132,50
A30-51	1/4"	1/4"	132,50

-5°C til +60°C, 10 bar

Ventil

PVDF (POLYVINYLIDENFLUORID)



Varenr.	Ø	Lysning	DKK
A30-20	5-7	4	314,00
A30-21	7-9	6	373,25
A30-22	9-11	8	437,75
A30-23	11-13	8	425,00

3-vejs ventil

PVDF (POLYVINYLIDENFLUORID)



Til brug i fødevarer industri.

Både L og T boret

Varenr.	Ø	Lysning	DKK
A30-40	5-7	4	493,00
A30-41	7-9	6	555,75
A30-42	9-11	8	611,50
A30-43	11-13	8	611,50

Push-on 3-vejs ventil

PP (POLYPROPYLEN)



Varenr.	3 × Ø/ø	Bund	DKK
A30-60	8/6	1/4"	140,25

-5°C til +60°C, 10 bar

Ventil push-in POM (ACETAL)



Varenr.	dim	DKK
AD120-6	ø6	87,65
AD120-8	ø8	87,65
AD120-0	ø10	89,60
AD120-12	ø12	96,95
AD120-1	ø15	132,50
AD120-2	ø15 × ø10	248,75
AD120-3	ø16	200,00
AD120-4	ø16 × ø10	200,00
AD120-5	ø22	248,75

Filter m. kontraventil PA (POLYAMID) / AISI 316



Varenr.	Mesh	Ø × H	DKK
Fi2-1	50	14,6 × 21	14,75
Fi2-2	100	14,6 × 21	16,30

Bundventil nip/muf PA (POLYAMID) - BSPP



Varenr.	BSPP	DKK
A390-8	1 1/2"	168,75 α
A390-9	2"	212,75 α

α = så længe lager haves

Udluftningsventil PA (POLYAMID) - BSPP



Varenr.	BSPP	BAR	DKK
AA4	1"	0,2 - 16	UDGÅET

Flow 0,2bar=95m³/h

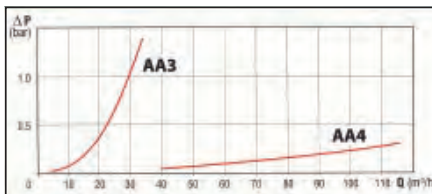

Udluftningsventil PA (POLYAMID) - BSPP



Varenr.	BSPP	BAR	DKK
AA1	2"	0,2 - 16	1085,75

Flow 0,3bar=365m³/h

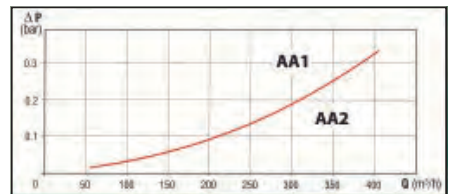

Udluftningsventil PA (POLYAMID) - BSPP



Varenr.	BSPP	BAR	DKK
AA3	1"	0,2 - 16	732,00

Flow 0,7bar=25m³/h

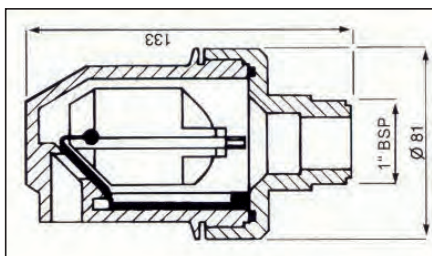

Udluftningsventil PA (POLYAMID) - BSPP



Varenr.	BSPP	BAR	DKK
AA2	2"	0,2 - 16	2731,75

Flow 0,3bar=365m³/h

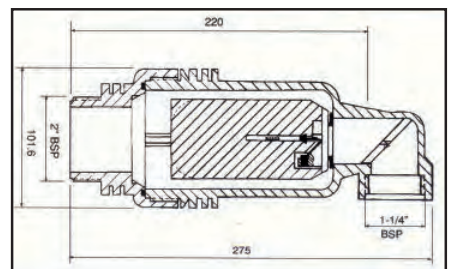

UDLUFTNINGSVENTILER

Bruges til at udlufte tanke, rør og lignende steder, hvor aftapning kan skabe vakuum eller påfyldning kan skabe overtryk. Krop lavet af PA, flyder af PP, pakninger af EPDM, O-ring af NBR.

DOBBELTVIRKENDE AA1 + AA4:

Uden pakning. Ved overtryk lukkes luft ud, men ikke væske. Ved undertryk lukkes luft ind.

DOBBELTVIRKENDE & AUTOMATISK AA3:

1 pakning. Ved overtryk lukkes luft ud, men ikke væske. Ved undertryk lukkes luft ind til normalt tryk. Lukker luftbobler ud automatisk ved normalt tryk.

DOBBELTVIRKENDE & AUTOMATISK AA2:

2 pakninger. Som AA3, men 2 pakninger muliggør, at ventilen er fuldstændig vandtæt, uanset hvor langsomt påfyldning eller aftapning foregår.

Aftapningsventil

POM (ACETAL) - 1/2" BSPT



Bruges til automatisk udtømning af kondenseret vand i trykluftsystemer, efter at der er lukket for tilførslen. Ventilen installeres i slutningen af linien.

Varenr.	BSPT	DKK
A32-2	1/2"	96,10

Vakuumløseventil

POM (ACETAL) - 1/2" BSPT



Monteres lodret på det højeste punkt og pegende opad. Fungerer som en anti-vakuumløseventil.

Varenr.	BSPT	DKK
A32-1	1/2"	86,80

VENTILER PVC



Max. 10bar (industri typer
max. 15bar)



0°C til +60°C



Forskellige typer af PVC ventiler, både til industri og hobbybrug.

Kugletætning er i alle tilfælde teflon (PTFE). O-ringe er typisk EPDM, dog visse modeller med VITON.

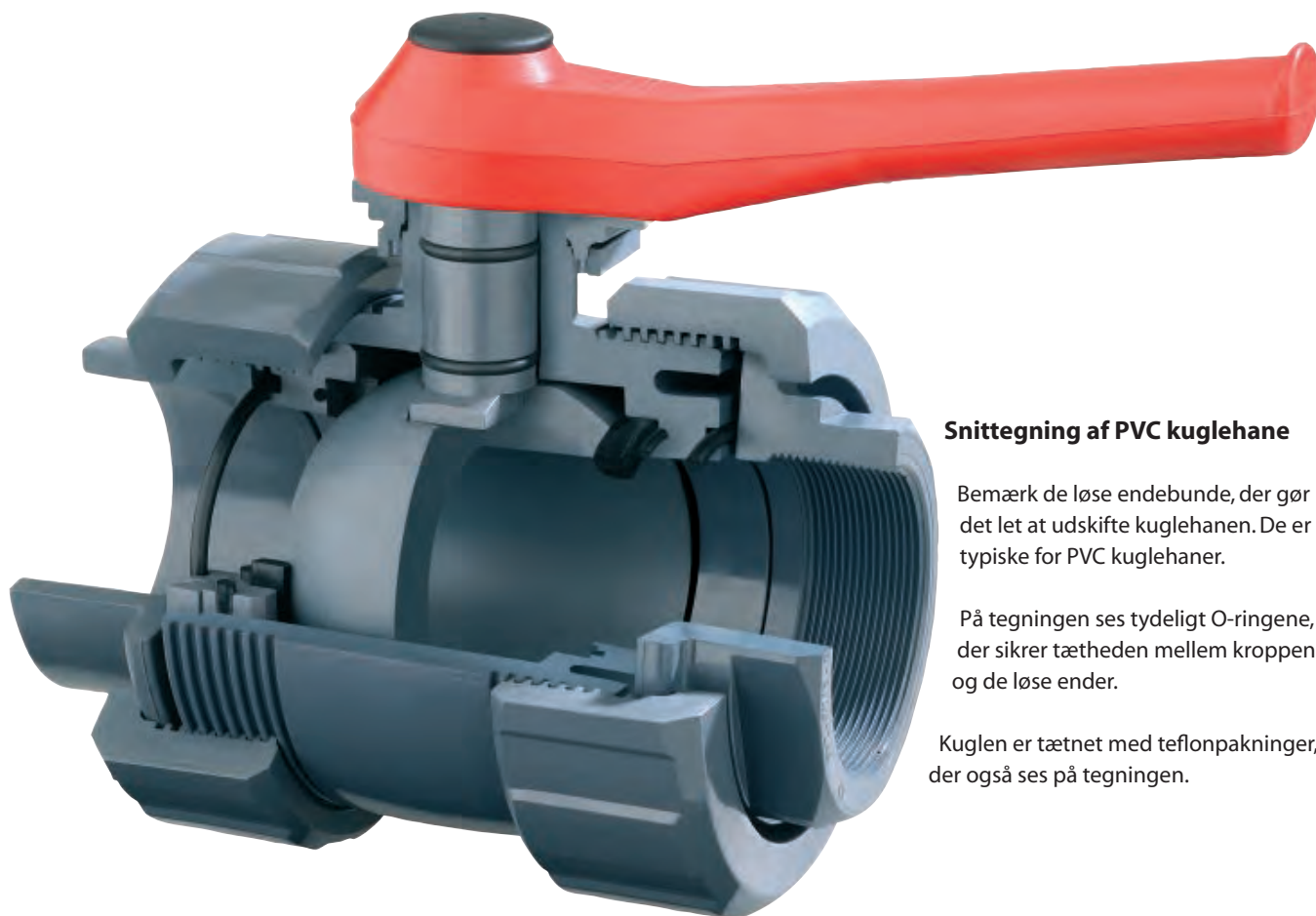

Snittegning af PVC kuglehane

Bemærk de løse endebunde, der gør det let at udskifte kuglehanen. De er typiske for PVC kuglehaner.

På tegningen ses tydeligt O-ringene, der sikrer tætheden mellem kroppen og de løse ender.

Kuglen er tætnet med teflonpakninger, der også ses på tegningen.

Kuglehane lim/lim
U-PVC (POLYVINYLCHLORID) / EPDM



Industrimodel

Varenr.	∅	DKK
AL33-16	16mm	237,25
AL33-20	20mm	244,00
AL33-25	25mm	298,50
AL33-32	32mm	353,75
AL33-40	40mm	454,25
AL33-50	50mm	576,75
AL33-63	63mm	718,25
AL33-75	75mm	1589,50
AL33-90	90mm	2030,25
AL33-110	110mm	2655,50

Kuglehane lim/lim
U-PVC (POLYVINYLCHLORID) / EPDM



Varenr.	∅	DKK
ALV33-16	16mm	83,80
ALV33-20	20mm	85,45
ALV33-25	25mm	91,20
ALV33-32	32mm	134,75
ALV33-40	40mm	167,25
ALV33-50	50mm	198,50
ALV33-63	63mm	318,25
ALV33-75	75mm	946,00
ALV33-90	90mm	1279,50
ALV33-110	110mm	1665,75

Kuglehane lim/lim
U-PVC (POLYVINYLCHLORID) / EPDM



Varenr.	∅	DKK
ALV33-16-1	16mm	64,95
ALV33-20-1	20mm	66,60
ALV33-25-1	25mm	74,55
ALV33-32-1	32mm	83,80
ALV33-40-1	40mm	117,75
ALV33-50-1	50mm	158,50
ALV33-63-1	63mm	272,75
ALV33-75-1	75mm	575,00
ALV33-90-1	90mm	714,50
ALV33-110-1	110mm	1300,00

Kuglehane lim/lim
U-PVC (POLYVINYLCHLORID) / VITON

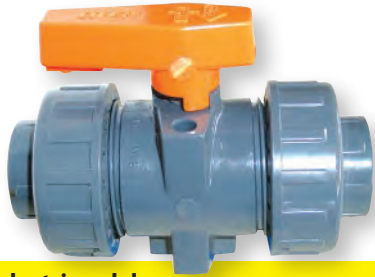

Industrimodel

Varenr.	∅	DKK
AL33-16-VITON	16mm	323,75
AL33-20-VITON	20mm	331,00
AL33-25-VITON	25mm	375,50
AL33-32-VITON	32mm	473,75
AL33-40-VITON	40mm	588,25
AL33-50-VITON	50mm	742,50
AL33-63-VITON	63mm	949,25
AL33-75-VITON	75mm	2036,50
AL33-90-VITON	90mm	2580,25
AL33-110-VITON	110mm	3472,25

Kuglehane muf/muf
U-PVC / EPDM - BSPP



Varenr.	BSPP	DKK
ARV33-3	3/8"	91,20
ARV33-4	1/2"	92,55
ARV33-5	3/4"	100,75
ARV33-6	1"	142,75
ARV33-7	1 1/4"	179,00
ARV33-8	1 1/2"	214,00
ARV33-9	2"	239,25
ARV33-10	2 1/2"	1004,25
ARV33-11	3"	1361,75
ARV33-12	4"	1745,00

Kuglehane muf/muf
U-PVC / EPDM - BSPP



Varenr.	BSPP	DKK
ARV33-3-1	3/8"	73,45
ARV33-4-1	1/2"	74,80
ARV33-5-1	3/4"	83,80
ARV33-6-1	1"	95,80
ARV33-7-1	1 1/4"	128,75
ARV33-8-1	1 1/2"	168,50
ARV33-9-1	2"	283,25
ARV33-10-1	2 1/2"	623,50
ARV33-11-1	3"	770,00
ARV33-12-1	4"	1361,75



Kuglehane nip/muf
U-PVC / EPDM - BSPP



Varenr.	BSPP × ∅	DKK
ARV33-3-2	3/8"	73,45
ARV33-4-2	1/2"	74,80
ARV33-5-2	3/4"	83,80
ARV33-6-2	1"	95,80
ARV33-7-2	1 1/4"	128,75
ARV33-8-2	1 1/2"	168,50
ARV33-9-2	2"	283,25



Kuglehane 3-vejs T

U-PVC (POLYVINYLCHLORID) - BSPP



Varenr.	ø	DKK
AL300T-50	50mm	948,00
AL300T-63	63mm	1135,25

Butterfly ventil indstillelig

U-PVC (POLYVINYLCHLORID)



Varenr.	ø	DN	DKK
AH29-63	63mm	50	464,50
AH29-75	75mm	65	521,50
AH29-90	90mm	80	604,75
AH29-110	110mm	100	643,00
AH29-125	125/140mm	125	800,00
AH29-160	160mm	150	1117,75
AH29-200	200mm	200	1417,50
AH29-250	250mm	225	3869,75
AH29-315	315mm	315	8595,50

Blåt håndtag

U-PVC (POLYVINYLCHLORID)



Type 1 = AL33/VITON
 Type 2 = ALV33-1/ARV33-1+2
 Type 3 = ALV33/ARV33

Varenr.	Str.	Type	DKK
AHI-16	16 ~ 3/8"	1	11,25
AHI-20	20 ~ 1/2"	1	12,00
AHI-25	25 ~ 3/4"	1	14,30
AHI-32	32 ~ 1"	1	18,55
AHI-40	40 ~ 1 1/4"	1	20,45
AHI-50	50 ~ 1 1/2"	1	26,25
AHI-63	63 ~ 2"	1	31,00
AHI-75	75 ~ 2 1/2"	1	63,65
AHI-90	90 ~ 3"	1	72,90
AHI-110	110 ~ 4"	1	96,40

AHV-16	16 ~ 3/8"	2	11,25
AHV-20	20 ~ 1/2"	2	12,00
AHV-25	25 ~ 3/4"	2	14,30
AHV-32	32 ~ 1"	2	18,55
AHV-40	40 ~ 1 1/4"	2	20,45
AHV-50	50 ~ 1 1/2"	2	26,25
AHV-63	63 ~ 2"	2	31,00
AHV-75	75 ~ 2 1/2"	2	63,65
AHV-90	90 ~ 3"	2	72,90
AHV-110	110 ~ 4"	2	96,40

AHS-16	16 ~ 3/8"	3	11,25
AHS-20	20 ~ 1/2"	3	12,00
AHS-25	25 ~ 3/4"	3	14,30
AHS-32	32 ~ 1"	3	18,55
AHS-40	40 ~ 1 1/4"	3	20,45
AHS-50	50 ~ 1 1/2"	3	26,25
AHS-63	63 ~ 2"	3	31,00
AHS-75	75 ~ 2 1/2"	3	63,65
AHS-90	90 ~ 3"	3	72,90
AHS-110	110 ~ 4"	3	96,40

Kuglehane 3-vejs L

U-PVC (POLYVINYLCHLORID) - BSPP



Varenr.	ø	DKK
AL300L-50	50mm	948,00
AL300L-63	63mm	1135,25

Kuglehane

U-PVC (POLYVINYLCHLORID)

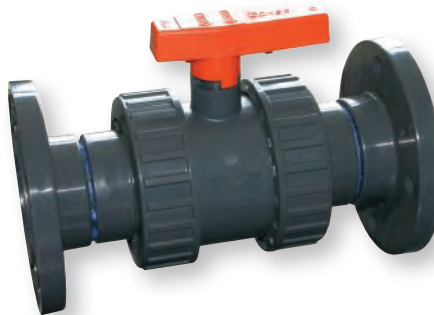

Varenr.	ø	DKK
AFV33-20	20mm	343,00
AFV33-25	25mm	404,50
AFV33-32	32mm	476,25
AFV33-40	40mm	600,50
AFV33-50	50mm	734,75
AFV33-63	63mm	908,50
AFV33-75	75mm	1776,75
AFV33-90	90mm	2246,50
AFV33-110	110mm	2933,50

Boltmål som ved DIN flanger

Kontraventil lim/lim

U-PVC (POLYVINYLCHLORID) / EPDM



Med fjeder og kegle

Varenr.	ø	H	DKK
AL70-16	16mm	76	205,75
AL70-20	20mm	80	205,75
AL70-25	25mm	91	218,25
AL70-32	32mm	102	237,25
AL70-40	40mm	120	277,00
AL70-50	50mm	140	331,00
AL70-63	63mm	169	427,00
AL70-75	75mm	214	1041,50
AL70-90	90mm	269	1344,25
AL70-110	110mm	290	3731,75

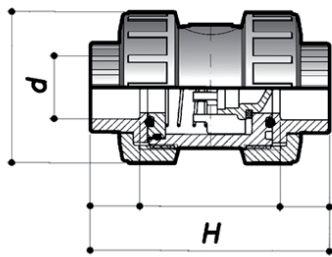

Udluftningsventil lim/lim

U-PVC (POLYVINYLCHLORID) / EPDM



Med kegle, UDEN fjeder

Varenr.	ø	H	DKK
AL71-16	16mm	76	172,25
AL71-20	20mm	80	172,25
AL71-25	25mm	91	196,25
AL71-32	32mm	102	205,75
AL71-40	40mm	120	242,75
AL71-50	50mm	140	294,00
AL71-63	63mm	169	380,25
AL71-75	75mm	214	926,25
AL71-90	90mm	269	1195,00
AL71-110	110mm	290	1769,75

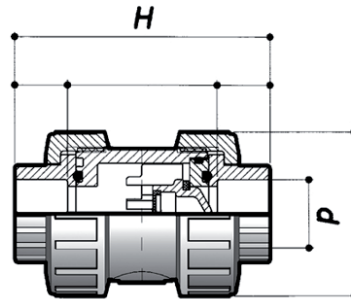

Bundventil lim/lim

U-PVC (POLYVINYLCHLORID) / EPDM



Med kegle, UDEN fjeder

Varenr.	ø	H	DKK
AL72-16	16mm	76	181,75
AL72-20	20mm	80	181,75
AL72-25	25mm	91	194,00
AL72-32	32mm	102	215,75
AL72-40	40mm	120	252,75
AL72-50	50mm	140	302,25
AL72-63	63mm	169	389,50
AL72-75	75mm	214	949,25
AL72-90	90mm	269	1223,75
AL72-110	110mm	290	1814,00

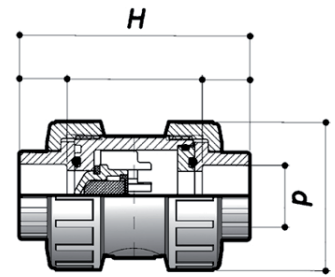

Kontraventil muf/muf

U-PVC / EPDM - BSPP



Med fjeder og kegle

Varenr.	BSPP	H	DKK
AR70-3	3/8"	76	218,25
AR70-4	1/2"	80	218,25
AR70-5	3/4"	91	231,00
AR70-6	1"	102	251,50
AR70-7	1 1/4"	120	291,00
AR70-8	1 1/2"	140	296,00
AR70-9	2"	169	442,75
AR70-10	2 1/2"	214	1153,75
AR70-11	3"	269	1498,75
AR70-12	4"	290	2277,50

Udluftningsventil muf/muf

U-PVC / EPDM - BSPP



Med kegle, UDEN fjeder

Varenr.	BSPP	H	DKK
AR71-3	3/8"	76	185,25
AR71-4	1/2"	80	185,25
AR71-5	3/4"	91	198,50
AR71-6	1"	102	218,25
AR71-7	1 1/4"	120	254,00
AR71-8	1 1/2"	140	307,75
AR71-9	2"	169	394,25
AR71-10	2 1/2"	214	1026,50
AR71-11	3"	269	1335,00
AR71-12	4"	290	1534,75

Bundventil muf/muf

U-PVC / EPDM - BSPP



Med kegle, UDEN fjeder

Varenr.	BSPP	H	DKK
AR72-3	3/8"	76	194,00
AR72-4	1/2"	80	194,00
AR72-5	3/4"	91	207,00
AR72-6	1"	102	226,00
AR72-7	1 1/4"	120	262,25
AR72-8	1 1/2"	140	316,75
AR72-9	2"	169	403,25
AR72-10	2 1/2"	214	1050,75
AR72-11	3"	269	1366,00
AR72-12	4"	290	2073,50

PVC kuglehane med stor flexibilitet, kan sammensættes efter behov. Eksempelvis:

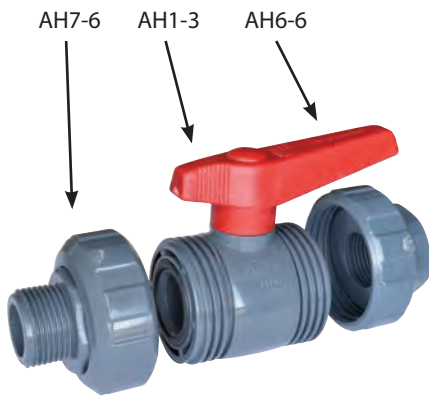

Kuglehanebasis U-PVC (POLYVINYLCHLORID) / EPDM



Modulær PVC ventil, der kan opbygges, som man ønsker.

Varenr.	Type	DKK
AH1-1	1A	57,35
AH1-2	2A	67,75
AH1-3	3A	101,75
AH1-4	4A	114,25
AH1-5	5A	153,25
AH1-6	6A	226,50
AH1-7	7A	946,00
AH1-8	8A	1060,00
AH1-9	9A	1919,00

Kuglehanebasis U-PVC (POLYVINYLCHLORID) / VITON



Modulær PVC ventil, der kan opbygges, som man ønsker.

Varenr.	Type	DKK
AH2-1	1A	91,20
AH2-2	2A	109,50
AH2-3	3A	157,50
AH2-4	4A	185,25
AH2-5	5A	256,00
AH2-6	6A	375,50
AH2-7	7A	1490,50
AH2-8	8A	1671,75
AH2-9	9A	3069,50

Kuglehanebasis indstillelig U-PVC (POLYVINYLCHLORID) / EPDM



PVC kuglehane med 11 indstillinger, der gør det muligt at låse på en given åbning hver gang.

Varenr.	Type	DKK
AH3-1	7A	1230,00
AH3-2	8A	1376,25
AH3-3	9A	2482,50

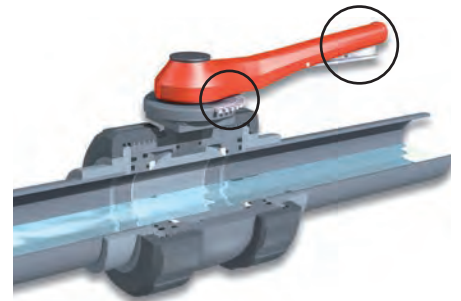

Kuglehanebasis indstillelig U-PVC (POLYVINYLCHLORID) / VITON



PVC kuglehane med 11 indstillinger, der gør det muligt at låse på en given åbning hver gang.

Varenr.	Type	DKK
AH4-1	7A	1943,75
AH4-2	8A	2172,50
AH4-3	9A	3972,75

O-ring/pakning

EPDM



Varenr.	Type	DKK
AH24-1	1A	3,71
AH24-2	2A	3,94
AH24-3	3A	7,75
AH24-4	4A	9,80
AH24-5	5A	18,00
AH24-6	6A	18,35
AH24-7	7A	19,00
AH24-8	8A	22,55
AH24-9	9A	119,75

O-ring/pakning

VITON



Varenr.	Type	DKK
AH25-1	1A	12,80
AH25-2	2A	16,10
AH25-3	3A	24,35
AH25-4	4A	39,70
AH25-5	5A	46,50
AH25-6	6A	69,90
AH25-7	7A	86,55
AH25-8	8A	101,75
AH25-9	9A	201,75

Endestykke til lim

U-PVC (POLYVINYLCHLORID)



Varenr.	ø	Type	DKK
AH5-1	20mm	1A	20,15
AH5-2	25mm	2A	24,95
AH5-3	32mm	3A	33,75
AH5-4	40mm	4A	44,20
AH5-5	50mm	5A	48,15
AH5-6	63mm	6A	73,70
AH5-7	75mm	7A	337,75
AH5-8	90mm	8A	380,25
AH5-9	110mm	9A	695,00

Endestykke med muffe

U-PVC (POLYVINYLCHLORID) - BSPP



Varenr.	BSPP	Type	DKK
AH6-4	1/2"	1A	20,15
AH6-5	3/4"	2A	24,95
AH6-6	1"	3A	33,75
AH6-7	1 1/4"	4A	44,20
AH6-8	1 1/2"	5A	48,15
AH6-9	2"	6A	73,70
AH6-10	2 1/2"	7A	491,00
AH6-11	3"	8A	529,25
AH6-12	4"	9A	812,50

Endestykke med nippel

U-PVC (POLYVINYLCHLORID) - BSPT



Varenr.	BSPT	Type	DKK
AH7-4	1/2"	1A	20,15
AH7-5	3/4"	2A	24,95
AH7-6	1"	3A	33,75
AH7-7	1 1/4"	4A	44,20
AH7-8	1 1/2"	5A	48,15
AH7-9	2"	6A	73,70

Skueglas muf/muf

U-PVC (POLYVINYLCHLORID) - BSPP



Varenr.	BSPP	DN	DKK
AH16-10	2 1/2"	100	2079,75
AH16-11	3"	100	2246,50
AH16-12	4"	100	2519,50

Skueglas til PE svejs

PE (POLYETHYLEN)



Varenr.	ø	DN	DKK
AH17-1	50mm	50	248,50 α
AH17-2	63mm	50	248,50 α
AH17-3	90mm	100	760,00 α
AH17-4	110mm	100	838,75 α
AH17-5	125mm	100	972,00 α

α = så længe lager haves

Skueglas til lim

U-PVC (POLYVINYLCHLORID)



Varenr.	ø	DN	DKK
AH18-1	40mm	50	669,50
AH18-2	50mm	50	734,75
AH18-3	63mm	50	867,50
AH18-4	90mm	100	2501,00
AH18-5	110mm	100	2797,50
AH18-6	125mm	100	3361,00
AH18-7	110mm	125	4060,50
AH18-8	125mm	125	5886,50
AH18-9	140mm	125	6201,75
AH18-10	160mm	125	6863,00

VENTILER PP



Varierende tryk, spørg om max tryk



Serie af PP multifunktion ventiler, der omfatter alm. ventiler, samt trevejs, firevejs og femvejs ventiler. Alle med stor gennemstrømning.

Kuglehane muf/muf

PP (POLYPROPYLEN) - BSPP



Varenr.	BSPP	BAR	DKK
E322-1	1/2"	16	146,25
E322-2	3/4"	16	146,25
E322-3	1"	16	178,00
E322-4	1 1/4"	10	290,50
E322-5	1 1/2"	10	311,50
E322-6	2"	10	397,50

Kuglehane muf/nip

PP (POLYPROPYLEN) - BSPP



Varenr.	BSPP	DKK
E329-3	3/4"	84,10
E329-4	1"	84,10

Kuglehane 3-vejs L

PP (POLYPROPYLEN) - BSPP



Varenr.	BSPP	BAR	DKK
E323-1	1/2"	16	204,25
E323-2	3/4"	16	204,25
E323-3	1"	16	237,25
E323-4	1 1/4"	10	365,75
E323-5	1 1/2"	10	431,00
E323-6	2"	10	538,25

Kuglehane muf/muf

PP (POLYPROPYLEN) - BSPP



Varenr.	BSPP	DKK
E333-3	3/8"	81,90
E333-4	1/2"	83,80
E333-5	3/4"	93,90
E333-6	1"	106,75
E333-7	1 1/4"	144,00
E333-8	1 1/2"	187,50
E333-9	2"	315,00
E333-10	2 1/2"	695,00
E333-11	3"	859,25

Kuglehane nip/muf max 10 bar

PP (POLYPROPYLEN)



Varenr.	BSPP	DKK
E339-5	3/4"	94,75

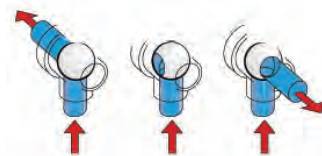

Kuglehane 3-vejs T

PP (POLYPROPYLEN) - BSPP



Varenr.	BSPP	DKK
E323-7	1/2"	215,00
E323-8	3/4"	215,00
E323-9	1"	247,75
E323-10	1 1/4"	379,00
E323-11	1 1/2"	448,50
E323-12	2"	559,25

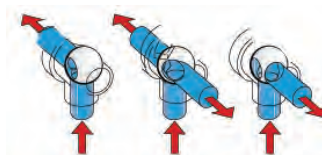



Sikkerhedskuglehane

PP (POLYPROPYLEN) - BSPP



Aftapningsventil til tanke m. farlig væske, m. sikkerhedsprop, så fejlåbning undgås. PP krop, TEFLON sæde, EPDM/VITON tætning.

Varenr.	BSPP	O-ring	DKK
E328-1	2"	EPDM	517,25
E328-2	2"	VITON	570,25

Ventil studs/nippel

PP (POLYPROPYLEN) - BSPP



Varenr.	Ø × BSPP	DKK
E321G-1	16 × 1/2"	36,60
E321G-2	20 × 1/2"	36,60
E321G-3	16 × 3/4"	36,60
E321G-4	20 × 3/4"	36,60
E321G-5	25 × 3/4"	36,60

Ventil studs/studs

PP (POLYPROPYLEN)



Varenr.	Ø	DKK
E321-1	16	33,75
E321-2	20 × 16	33,75
E321-3	20	33,75
E321-4	25	33,75

Kuglehane muf/muf PN16

PP (POLYPROPYLEN) - BSPP



Fuld gennemgang

Frostsikker til -10°C

Varenr.	BSPP	DKK
E336-4	1/2"	71,25
E336-5	3/4"	96,95
E336-6	1"	134,50
E336-7	1 1/4"	215,00
E336-8	1 1/2"	318,00
E336-9	2"	431,00

Kuglehane muf/muf

PP (POLYPROPYLEN) - BSPP



Frostsikker til -10°C

Varenr.	BSPP	DKK
E337-4	1/2"	71,25
E337-5	3/4"	96,95
E337-6	1"	134,50

Aftapningshane nip/studs

PP (POLYPROPYLEN) - BSPP



Frostsikker til -10°C

Varenr.	BSPP	DKK
E338-4	1/2"	94,90
E338-5	3/4"	222,75
E338-6	1"	183,25

Spadeventil

PP (POLYPROPYLEN) - BSPP



Gevind:

E334-1 - E334-3: nippel/nippel
E334-4 - E334-6: muffe/nippel
E334-7 - E334-9: muffe/muffe

Varenr.	dim	DKK
E334-1	1 1/4"	346,00
E334-2	1 1/2"	346,00
E334-3	2"	346,00
E334-4	1 1/4"	354,25
E334-5	1 1/2"	354,25
E334-6	2"	354,25
E334-7	1 1/4"	358,75
E334-8	1 1/2"	358,75
E334-9	2"	358,75

Aftapningshane nip/studs

PP (POLYPROPYLEN) - BSPT



Varenr.	BSPT	Ø	DKK
E324-1	1/2"	20	114,00
E324-2	3/4"	25	117,25
E324-3	1"	30	141,50

Aftapningshane muf/studs

PP (POLYPROPYLEN) - BSPT



Varenr.	BSPT	Ø	DKK
E324F-1	1/2"	20	114,00
E324F-2	3/4"	25	117,25
E324F-2-1	1"	25	141,50
E324F-3	1"	30	141,50

Aftapningshane

PP (POLYPROPYLEN) - BSPT



Varenr.	BSPT	DKK
E326-1	3/4"	27,00
E326-2	3/4"	28,15

Tud: E326-1 = ø8,5 E326-2 = ø17,5

Aftapningshane

PP (POLYPROPYLEN)



Varenr.	Str.	DKK
K25-1	DIN51	69,35
K25-2	DIN61	69,35

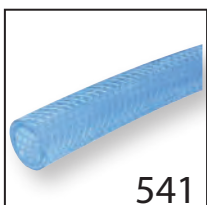

Kuglehane 2-vejs
PP (POLYPROPYLEN) - BSPP



Varenr.	BSPP	DN	BAR	DKK
AA381-6	1"	25	16	397,50
AA381-7	1 1/4"	32	16	397,50
AA381-8	1 1/2"	40	10	694,00
AA381-9	2"	50	10	694,00
AA381-10	2 1/2"	65	8	1224,75
AA381-11	3"	65	8	1224,75

Kuglehane 3-vejs L/T
PP (POLYPROPYLEN) - BSPP



Varenr.	BSPP	DN	BAR	DKK
AA382-6	1"	25	16	530,75
AA382-7	1 1/4"	32	16	530,75
AA382-8	1 1/2"	40	10	747,75
AA382-9	2"	50	10	1224,75
AA382-10	2 1/2"	65	8	1224,75
AA382-11	3"	65	8	1169,25



Kuglehane 4-vejs
PP (POLYPROPYLEN) - BSPP



Varenr.	BSPP	DN	BAR	DKK
AA384-9	2"	50	6	4037,75

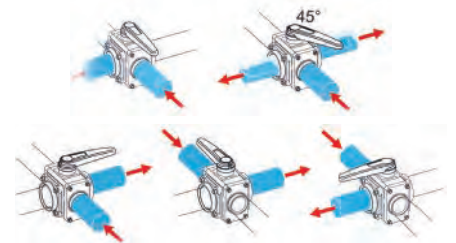

Kuglehane 3-vejs L
PP (POLYPROPYLEN) - BSPP



Bundtilslutning				
Varenr.	BSPP	DN	BAR	DKK
AA383-6	1"	25	16	536,75
AA383-7	1 1/4"	32	16	536,75
AA383-8	1 1/2"	40	10	650,25
AA383-9	2"	50	10	867,25
AA383-10	2 1/2"	65	8	1652,25
AA383-11	3"	65	8	1652,25

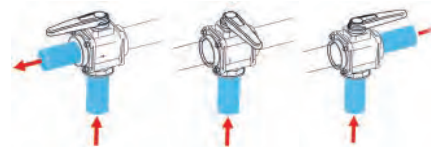

Kuglehane 5-vejs
PP (POLYPROPYLEN) - BSPP



Varenr.	BSPP	DN	BAR	DKK
AA385-9	2"	50	6	4692,75
AA385-11	3"	75	3	4692,75

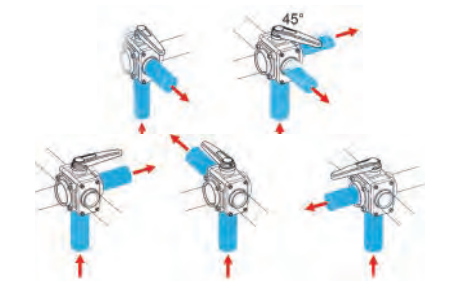

KONTRAVENTILER RUSTFRI



Typisk max. 16bar, nogle dog højere



Afhænger af pakning, se andetsteds



Serie af rustfri ventiler med et bredt spektrum af varianter og dimensioner.

KONTRAVENTIL 304 & 316

Krop og metalliske dele er i rustfri stål, AISI 304 eller 316.

TÆTNING:

NBR - EPDM - FPM eller PTFE.

GEVIND ENDER:

UNI ISO 228 hunpart

OPENING TRYK: Max 0,03 bar

ARBEJDSTRYK: Max 16 bar

ARBEJDS TEMP.:

NBR -25°C - +90°C

EPDM -20°C - +110°C

FPM -20°C - +150°C

PTFE -20°C - +200°C

Ikke lagerførte kontraventiler, leveringstid ca. 4 uger fra ordre.

B70-52

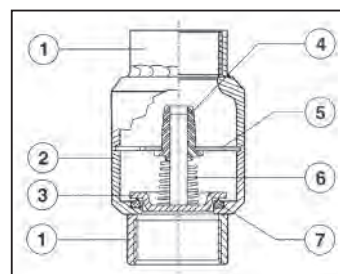
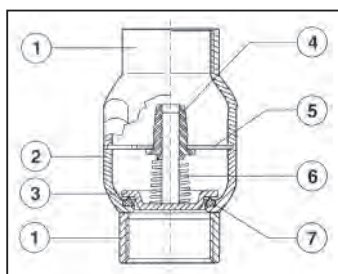

- 1 Gevind ende
- 2 Krop
- 3 Flow kontrol
- 4 Styrebøsning
- 5 Støtte for tætningsring
- 6 Fjeder
- 7 Tætningsring

B70-53

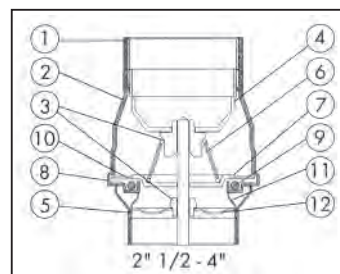
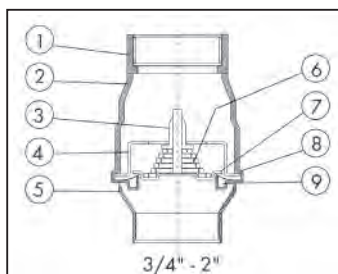

- 1 Udløbsende
- 2 Krop
- 3 Styrebøsning
- 4 Flow kontrol
- 5 Indløbsende
- 6 Fjeder
- 7 Flow kontrol
- 8 Hus til tætningsring
- 9 Tætningsring
- 10 Holder til tætningsring
- 11 Tætning/ krop
- 12 Flader

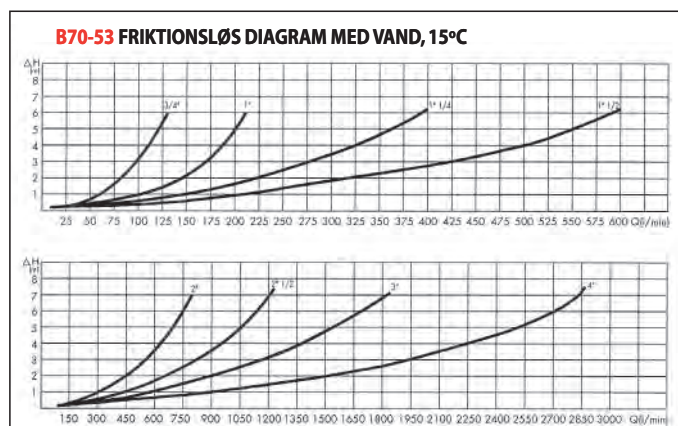
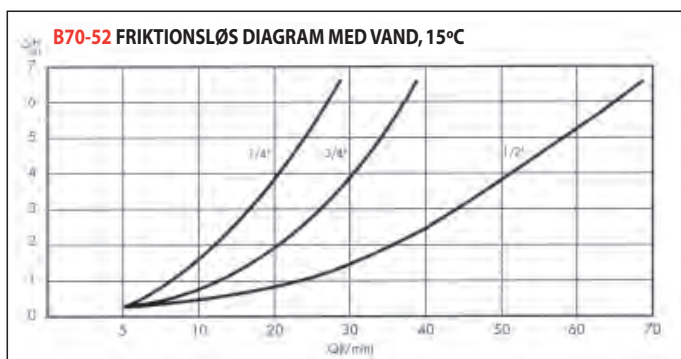

Kontraventil AISI 304 - BSPP



Varenr.	BSPP	O-ring	DKK
B70-52-1	1/4"	NBR	338,00
B70-52-2	3/8"	NBR	338,00
B70-52-3	1/2"	NBR	338,00
B70-52-4	1/4"	EPDM	351,00
B70-52-5	3/8"	EPDM	351,00
B70-52-6	1/2"	EPDM	351,00
B70-52-7	1/4"	FPM	588,75
B70-52-8	3/8"	FPM	588,75
B70-52-9	1/2"	FPM	588,75

Kontraventil AISI 316 - BSPP



Varenr.	BSPP	O-ring	DKK
B70-52-10	1/4"	FPM	624,50
B70-52-11	3/8"	FPM	624,50
B70-52-12	1/2"	FPM	624,50

Dim	A	B	C	Kg
1/4"	1/4"	54	32	125
3/8"	3/8"	54	32	115
1/2"	1/2"	54	32	95

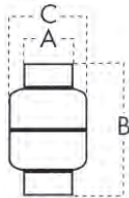

Filter t. kontraventil AISI 304 - BSPP



Varenr.	BSPP	DKK
B370s-4-304	1/2"	85,20
B370s-5-304	3/4"	102,25
B370s-6-304	1"	120,75
B370s-7-304	1 1/4"	134,50
B370s-8-304	1 1/2"	159,50
B370s-9-304	2"	199,00
B370s-10-304	2 1/2"	538,25
B370s-11-304	3"	566,50
B370s-12-304	4"	637,50

Extern montering

Kontraventil AISI 304 - BSPP



Varenr.	BSPP	O-ring	DKK
B70-53-1	3/4"	NBR	425,25
B70-53-2	1"	NBR	486,50
B70-53-3	1 1/4"	NBR	550,00
B70-53-4	1 1/2"	NBR	640,50
B70-53-5	2"	NBR	1375,50
B70-53-6	2 1/2"	NBR	2108,50
B70-53-7	3"	NBR	2888,75
B70-53-8	4"	NBR	4824,75

B70-53-9	3/4"	EPDM	382,25
B70-53-10	1"	EPDM	441,75
B70-53-11	1 1/4"	EPDM	662,00
B70-53-12	1 1/2"	EPDM	765,25
B70-53-13	2"	EPDM	1235,00
B70-53-14	2 1/2"	EPDM	2108,50
B70-53-15	3"	EPDM	2888,75
B70-53-16	4"	EPDM	4824,75

B70-53-17	3/4"	FPM	440,50 α
B70-53-18	1"	FPM	508,50 α
B70-53-19	1 1/4"	FPM	662,00 α
B70-53-20	1 1/2"	FPM	765,25 α
B70-53-21	2"	FPM	1419,75 α
B70-53-22	2 1/2"	FPM	2433,00 α
B70-53-23	3"	FPM	3318,00
B70-53-24	4"	FPM	4824,75

α = lagerføres

Dim	A	B	C	Kg
3/4"	DN20	70	44	129
1"	DN25	84	53	191
1 1/4"	DN32	99	62	281
1 1/2"	DN40	119	78	388
2"	DN50	123	89	704
2 1/2"	DN65	147	113	1425
3"	DN80	166	132	2085
4"	DN100	193	167	3415

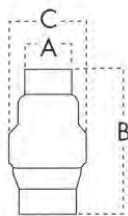

Kontraventil AISI 316 - BSPP



Varenr.	BSPP	O-ring	DKK
B70-53-33	3/4"	FPM	691,25 α
B70-53-34	1"	FPM	825,25 α
B70-53-35	1 1/4"	FPM	1039,50 α
B70-53-36	1 1/2"	FPM	1240,25 α
B70-53-37	2"	FPM	2353,25 α
B70-53-38	2 1/2"	FPM	3093,50
B70-53-39	3"	FPM	5103,00
B70-53-40	4"	FPM	7627,25

B70-53-41	3/4"	PTFE	1037,00 α
B70-53-42	1"	PTFE	1167,75 α
B70-53-43	1 1/4"	PTFE	1324,25
B70-53-44	1 1/2"	PTFE	1693,75
B70-53-45	2"	PTFE	2616,75
B70-53-46	2 1/2"	PTFE	4435,25
B70-53-47	3"	PTFE	6582,50
B70-53-48	4"	PTFE	9408,00

α = lagerføres

Filter t. kontraventil AISI 316 - BSPP



Varenr.	BSPP	DKK
B370s-4-316	1/2"	155,75
B370s-5-316	3/4"	184,25
B370s-6-316	1"	219,50
B370s-7-316	1 1/4"	249,25
B370s-8-316	1 1/2"	290,25
B370s-9-316	2"	431,75
B370s-10-316	2 1/2"	949,25
B370s-11-316	3"	1005,00
B370s-12-316	4"	1094,25

Extern montering

Kontraventil højtryk muffe/ muffe

AISI 316 / VITON - BSPP



MAX 100 bar, MIN 0,5 bar

Varenr.	BSPP	Lxdiag.xNV	O	DKK
B71-2	1/4"	45x19x17	5,5	287,50
B71-3	3/8"	50x22x20	7,5	287,50
B71-4	1/2"	60x27x24	10,5	314,75
B71-5	3/4"	68x36x32	15	376,00
B71-6	1"	83x43x38	20	498,25

NV = nøglevidde, O = lysning

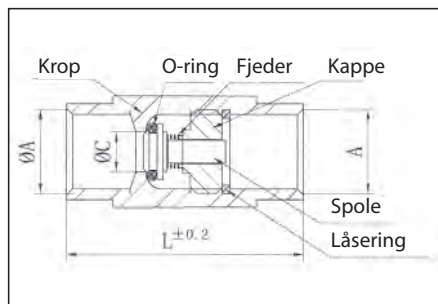

Kontraventil højtryk nippel/ muffe

AISI 316 / VITON - BSPTxBSPP



MAX 100 bar, MIN 0,5 bar

Varenr.	dim	Lxdiag.xNV	O	DKK
B72-2	1/4"	45x19x17	5,5	287,50
B72-3	3/8"	50x22x20	7,5	287,50
B72-4	1/2"	60x27x24	10,5	314,75
B72-5	3/4"	68x36x32	15	376,00
B72-6	1"	83x43x38	20	498,25

NV = nøglevidde, O = lysning

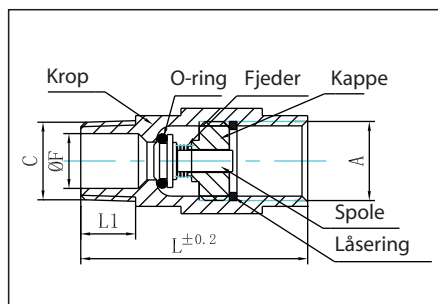

Drøvelekontraventil muffe/muf

AISI 316 / VITON - BSPP



Speciel, fordi åbningstrykket kan reguleres med en Unbrakonøgle. Min 0,2 bar, max 3,4 bar.

Justerbart åbningstryk

Varenr.	BSPP	DKK
B73-2	1/4"	550,50

Drøvelekontraventil nippel/nippel

AISI 316 / VITON - BSPT



Speciel, fordi åbningstrykket kan reguleres med en Unbrakonøgle. Min 0,2 bar, max 3,4 bar.

Justerbart åbningstryk

Varenr.	BSPT	DKK
B74-2	1/4"	550,50

Kontraventil muffe/muffe

AISI 316 - BSPP



Varenr.	BSPP	DKK
BA1-2	1/4"	2201,00
BA1-3	3/8"	2201,00
BA1-4	1/2"	2201,00
BA1-5	3/4"	2584,25
BA1-6	1"	3893,50
BA1-7	1 1/4"	5730,00

Bestillingsvare

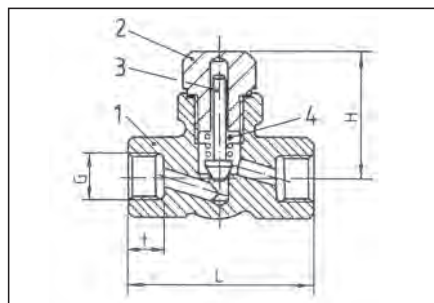

Kontraventil skæring/nip

AISI 316 - BSPP



Højtryk 100-400 bar

Varenr.	ø × BSPP	Type	bar	DKK
CP74-1	6 × 1/8"	RV-LG	250	722,75
CP74-2	8 × 1/4"	RV-LG	250	791,75
CP74-3	10 × 1/4"	RV-LG	250	929,25
CP74-4	12 × 3/8"	RV-LG	250	1101,25
CP74-5	15 × 1/2"	RV-LG	250	1239,25
CP74-6	18 × 1/2"	RV-LG	160	1617,25
CP74-7	22 × 3/4"	RV-LG	160	2340,25
CP74-8	28 × 1"	RV-LG	100	3130,25
CP74-9	35 × 1 1/4"	RV-LG	100	4503,25
CP74-10	42 × 1 1/2"	RV-LG	100	6359,25

CP74-11	6 × 1/4"	RV-SG	630	791,75
CP74-12	8 × 1/4"	RV-SG	630	826,25
CP74-13	10 × 3/8"	RV-SG	630	963,75
CP74-14	12 × 3/8"	RV-SG	630	1032,25
CP74-15	14 × 1/2"	RV-SG	630	1170,25
CP74-16	16 × 1/2"	RV-SG	400	1410,25
CP74-17	20 × 3/4"	RV-SG	400	2234,25
CP74-18	25 × 1"	RV-SG	400	2853,25
CP74-19	30 × 1 1/4"	RV-SG	400	4126,25
CP74-20	38 × 1 1/2"	RV-SG	400	5570,25

Leveringstid 3-6 dage for skaffeverer

Kontraventil skæring

AISI 316



Højtryk 100-400 bar

Varenr.	ø	Type	bar	DKK
CP75-1	6	RD-L	250	756,75
CP75-2	8	RD-L	250	826,25
CP75-3	10	RD-L	250	1032,25
CP75-4	12	RD-L	250	1136,25
CP75-5	15	RD-L	250	1342,25
CP75-6	18	RD-L	160	1754,25
CP75-7	22	RD-L	160	2340,25
CP75-8	28	RD-L	100	3000,50
CP75-9	35	RD-L	100	4091,25
CP75-10	42	RD-L	100	6153,25

CP75-11	6	RD-S	630	859,50
CP75-12	8	RD-S	630	895,25
CP75-13	10	RD-S	630	997,75
CP75-14	12	RD-S	630	1101,25
CP75-15	14	RD-S	630	1239,25
CP75-16	16	RD-S	400	1513,25
CP75-17	20	RD-S	400	2340,25
CP75-18	25	RD-S	400	2812,00
CP75-19	30	RD-S	400	4161,25
CP75-20	38	RD-S	400	5982,25

Leveringstid 3-6 dage for skaffeverer

Kontraventil skæring/nip

AISI 316 - BSPP



Højtryk 100-400 bar

Varenr.	ø × BSPP	Type	bar	DKK
CP72-1	6 × 1/8"	RZ-LG	250	722,75
CP72-2	8 × 1/4"	RZ-LG	250	791,75
CP72-3	10 × 1/4"	RZ-LG	250	929,25
CP72-4	12 × 3/8"	RZ-LG	250	1101,25
CP72-5	15 × 1/2"	RZ-LG	250	1239,25
CP72-6	18 × 1/2"	RZ-LG	160	1617,25
CP72-7	22 × 3/4"	RZ-LG	160	2340,25
CP72-8	28 × 1"	RZ-LG	100	3130,25
CP72-9	35 × 1 1/4"	RZ-LG	100	4503,25
CP72-10	42 × 1 1/2"	RZ-LG	100	6359,25

CP72-11	6 × 1/4"	RZ-SG	630	791,75
CP72-12	8 × 1/4"	RZ-SG	630	826,25
CP72-13	10 × 3/8"	RZ-SG	630	963,75
CP72-14	12 × 3/8"	RZ-SG	630	1032,25
CP72-15	14 × 1/2"	RZ-SG	630	1170,25
CP72-16	16 × 1/2"	RZ-SG	400	1410,25
CP72-17	20 × 3/4"	RZ-SG	400	2234,25
CP72-18	25 × 1"	RZ-SG	400	2853,25
CP72-19	30 × 1 1/4"	RZ-SG	400	4126,25
CP72-20	38 × 1 1/2"	RZ-SG	400	5570,25

Leveringstid 3-6 dage for skaffeverer



462

Kontraventil skrå muffe/muffe

AISI 316 - BSPP



Med fjederlukning

Varenr.	BSPP	DKK
B90-3-1	3/8"	802,50
B90-4-1	1/2"	744,50
B90-5-1	3/4"	847,00
B90-6-1	1"	1026,50
B90-7-1	1 1/4"	1206,25
B90-8-1	1 1/2"	1693,50
B90-9-1	2"	2337,25

Kontraklapventil muffe/muffe

AISI 316 - BSPP



Varenr.	BSPP	DKK
B90-4	1/2"	744,50
B90-5	3/4"	847,00
B90-6	1"	1026,50
B90-7	1 1/4"	1206,25
B90-8	1 1/2"	1693,50
B90-9	2"	2337,25

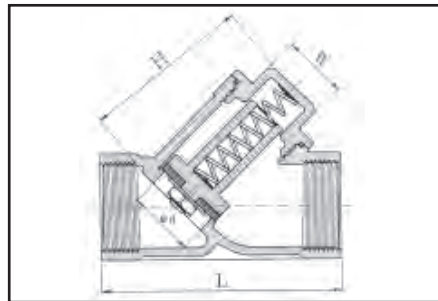

Kontraklapventil

AISI 316



AISI 316 kontraklapventil til spildevand i F6 byggemål med PN10 flanger.

Varenr.	DN	Byg L	DKK
OP150-50	50	200	¤
OP150-65	65	240	¤
OP150-80	80	260	¤
OP150-100	100	300	¤
OP150-125	125	350	¤
OP150-150	150	400	¤

¤ = spørg på pris

Kontraklapventil

AISI 316 / FPM



AISI 316 kontraklapventil til spildevand. Meget kompakt model.

Varenr.	DN	DKK
OP152-32	32	691,00
OP152-40	40	782,00
OP152-50	50	1061,00
OP152-65	65	1278,25
OP152-80	80	1697,50
OP152-100	100	2393,00
OP152-125	125	2989,75
OP152-150	150	4015,75
OP152-200	200	6357,75

Pladekontraventil

AISI 316



Rustfri syrefast kontraventil til indbygning mellem 2 flanger.

Leveres med montageclips.

Varenr.	DN	DKK
B92-4	15	172,00
B92-5	20	206,25
B92-6	25	269,75
B92-7	32	385,50
B92-8	40	459,75
B92-9	50	666,25
B92-10	65	951,75
B92-11	80	1319,00
B92-12	100	1992,00

Kuglekontraventil m. dræn

AISI 316 / KUGLE = NBR



AISI 316 kuglekontraventil til spildevand med mufte gevindender.

Varenr.	BSPP	DKK
OP144-8	1 1/2"	1116,00
OP144-9	2"	1265,00

Kuglekontraventil

AISI 316 / KUGLE = NBR



AISI 316 kuglekontraventil til spildevand i F6 byggemål med PN10 flanger.

Varenr.	DN	Byg L	DKK
OP140-50	50	200	5817,25
OP140-65	65	230	11740,25
OP140-80	80	260	13647,75
OP140-100	100	300	14239,25
OP140-125	125	350	25949,00
OP140-150	150	400	34598,50



462

VENTILER

KONTRAVENTILER MESSING



Kontraventil "yacht"

MESSING - BSPP



Varenr.	BSPP	DKK
E360-2	1/4"	58,70
E360-3	3/8"	58,70
E360-4	1/2"	58,70
E360-5	3/4"	73,50
E360-6	1"	90,15
E360-7	1 1/4"	143,25
E360-8	1 1/2"	206,75
E360-9	2"	355,00
E360-10	2 1/2"	584,50
E360-11	3"	817,00
E360-12	4"	1357,75

Filter

AISI 304 / PA (POLYAMID) - BSPT



Varenr.	Dim	DKK
E370-4	1/2"	25,60
E370-5	3/4"	29,25
E370-6	1"	31,30
E370-7	1 1/4"	28,35
E370-8	1 1/2"	34,15
E370-9	2"	45,90
E370-10	2 1/2"	101,25
E370-11	3"	126,50
E370-12	4"	200,50

Kontraventil muf/muf

MESSING - BSPP

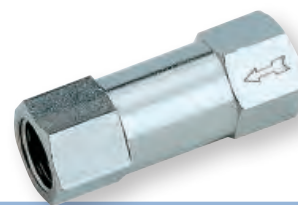

Varenr.	BSPP	DKK
E6062-0	M5	61,00
E6062-1	1/8"	81,00
E6062-2	1/4"	119,00
E6062-3	3/8"	135,00
E6062-4	1/2"	140,50

-20° til +80°C. Min 2 bar, max 8

Kontraventil nip/nip

MESSING / NBR - BSPT



Varenr.	BSPT	DKK
E436-1	1/4"	10,90

Kontraventil m. aftap.

MESSING - BSPP



Varenr.	BSPP	DKK
E361-4	1/2"	103,00
E361-5	3/4"	123,25
E361-6	1"	222,00

Kontraventil nip/muf

MESSING - BSPP



Varenr.	BSPP	DKK
E6063-0	M5	82,95
E6063-1	1/8"	79,05
E6063-2	1/4"	97,40
E6063-3	3/8"	212,25
E6063-4	1/2"	217,00

-20° til +80°C. Min 2 bar, max 8

Kontraventil push-in/nip

MESSING - BSPT

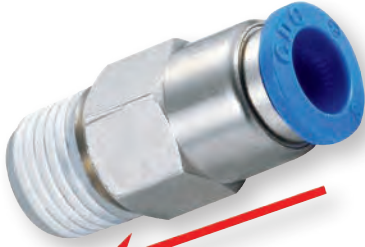

Store størrelser = ALU

Varenr.	ø × BSPT	DKK
EC130K-0418	4 × 1/8"	87,65
EC130K-0618	6 × 1/8"	93,90
EC130K-0614	6 × 1/4"	98,55
EC130K-0818	8 × 1/8"	104,25
EC130K-0814	8 × 1/4"	109,75
ALU		
EC130K-1038	10 × 3/8"	230,50
EC130K-1012	10 × 1/2"	242,50
EC130K-1238	12 × 3/8"	238,50
EC130K-1212	12 × 1/2"	249,50

Åbningstryk: 0,1 - 0,2 bar

Kontraventil nip/push-in

MESSING - BSPT



Store størrelser = ALU

Varenr.	ø × BSPT	DKK
EC130KA-0418	4 × 1/8"	87,65
EC130KA-0618	6 × 1/8"	93,90
EC130KA-0614	6 × 1/4"	98,55
EC130KA-0818	8 × 1/8"	104,25
EC130KA-0814	8 × 1/4"	109,75
ALU		
EC130KA-1038	10 × 3/8"	230,50
EC130KA-1012	10 × 1/2"	242,50
EC130KA-1238	12 × 3/8"	236,25
EC130KA-1212	12 × 1/2"	249,50

Åbningstryk: 0,1 - 0,2 bar

Kontraventil muf/nip

MESSING - BSPT×BSPP

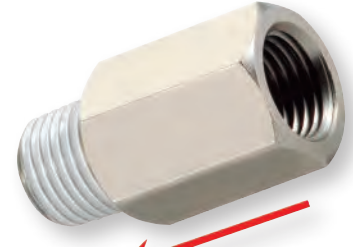

Åbningstryk: 0,1 - 0,2 bar

Varenr.	BSPT × BSPP	DKK
EC131K-01	1/8"	114,25
EC131K-02	1/4"	127,00
EC131K-03	3/8"	226,25
EC131K-04	1/2"	251,25

Kontraventil push-in/nip

MESSING - BSPP

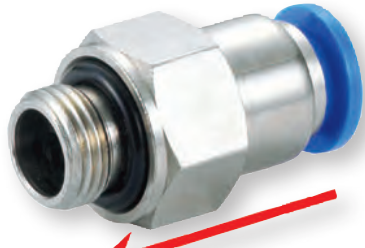

Store størrelser = ALU

Varenr.	ø × BSPP	DKK
EC130C-04M5	4 × M5	96,95
EC130C-04M6	4 × M6	96,95
EC130C-0418	4 × 1/8"	87,65
EC130C-0618	6 × 1/8"	93,90
EC130C-0614	6 × 1/4"	98,55
EC130C-0818	8 × 1/8"	104,25
EC130C-0814	8 × 1/4"	109,75
ALU		
EC130C-1038	10 × 3/8"	230,50
EC130C-1012	10 × 1/2"	242,50
EC130C-1238	12 × 3/8"	238,50
EC130C-1212	12 × 1/2"	249,50

Åbningstryk: 0,1 - 0,2 bar

Kontraventil nip/push-in

MESSING - BSPP

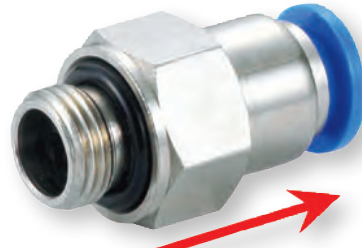

Store størrelser = ALU

Varenr.	ø × BSPP	DKK
EC130CA-04M5	4 × M5	96,95
EC130CA-04M6	4 × M6	96,95
EC130CA-0418	4 × 1/8"	87,65
EC130CA-0618	6 × 1/8"	93,90
EC130CA-0614	6 × 1/4"	98,55
EC130CA-0818	8 × 1/8"	104,25
EC130CA-0814	8 × 1/4"	109,75
ALU		
EC130CA-1038	10 × 3/8"	230,50
EC130CA-1012	10 × 1/2"	242,50
EC130CA-1238	12 × 3/8"	238,50
EC130CA-1212	12 × 1/2"	249,50

Åbningstryk: 0,1 - 0,2 bar

Kontraventil muf/nip

MESSING - BSPP



Åbningstryk: 0,1 - 0,2 bar

Varenr.	BSPP	DKK
EC131C-01	1/8"	114,25
EC131C-02	1/4"	127,00
EC131C-03	3/8"	227,75
EC131C-04	1/2"	251,25

Kontraventil nip/muf

MESSING - BSPT×BSPP



Åbningstryk: 0,1 - 0,2 bar

Varenr.	BSPT × BSPP	DKK
EC131KA-01	1/8"	114,25
EC131KA-02	1/4"	127,00
EC131KA-03	3/8"	226,25
EC131KA-04	1/2"	251,25

Kontraventil nip/muf

MESSING - BSPP



Åbningstryk: 0,1 - 0,2 bar

Varenr.	BSPP	DKK
EC131CA-01	1/8"	114,25
EC131CA-02	1/4"	127,00
EC131CA-03	3/8"	227,75
EC131CA-04	1/2"	228,25

Kontraklapventil muf/muf

MESSING - BSPP



Varenr.	BSPP	DKK
430377003	3/8"	65,45 α
430377004	1/2"	116,75
430377006	3/4"	151,75
430377008	1"	220,00
430377010	1 1/4"	295,25
430377011	1 1/2"	292,50
430377012	2"	616,25
430377013	2 1/2"	969,25
430377014	3"	1415,50
430377016	4"	1943,75

α = IKKE VA-godkendt



KONTRAVENTILER PLAST



Kontraventil

PP (POLYPROPYLEN) / EPDM - BSPP



Varenr.	BSPP	DKK
A330-7	1 1/4"	166,75
A330-8	1 1/2"	168,75
A330-9	2"	178,00

Kontraventil push-in

POM (ACETAL)



Dobbeltvirkende

Varenr.	dim	DKK
AD122-1	ø15	182,25

Kuglekontraventil lim/lim

U-PVC (POLYVINYLCHLORID)



Varenr.	ø	DKK
AL69-32	32mm	507,75
AL69-40	40mm	573,75
AL69-50	50mm	779,25
AL69-63	63mm	1109,50

Kontraventil push-in

POM (ACETAL)



Varenr.	dim	DKK
AD113-3	ø6	147,25
AD113-4	ø8	157,75
AD113-5	ø10	176,50
AD113-6	ø12	196,75

Kontraventil studs/studs

POM (ACETAL)



Varenr.	Ø	DKK
A29-20	6-8mm	69,10
A29-21	8-10mm	69,10
A29-22	10-14mm	87,35

Kuglekontraventil muf/muf

PVC (POLYVINYLCHLORID)



Varenr.	BSPP	DKK
AR69-6	1"	441,00
AR69-7	1 1/4"	502,75
AR69-8	1 1/2"	665,50
AR69-9	2"	931,25

Filter m. kontraventil

PA (POLYAMID) / AISI 316



Varenr.	Mesh	Ø × H	DKK
Fi2-1	50	14,6 × 21	14,75
Fi2-2	100	14,6 × 21	16,30

Kontraventil lim/lim

U-PVC (POLYVINYLCHLORID) / EPDM



Med fjeder og kegle

Varenr.	ø	H	DKK
AL70-16	16mm	76	205,75
AL70-20	20mm	80	205,75
AL70-25	25mm	91	218,25
AL70-32	32mm	102	237,25
AL70-40	40mm	120	277,00
AL70-50	50mm	140	331,00
AL70-63	63mm	169	427,00
AL70-75	75mm	214	1041,50
AL70-90	90mm	269	1344,25
AL70-110	110mm	290	3731,75

Kontraventil muf/muf

U-PVC / EPDM - BSPP



Med fjeder og kegle

Varenr.	BSPP	H	DKK
AR70-3	3/8"	76	218,25
AR70-4	1/2"	80	218,25
AR70-5	3/4"	91	231,00
AR70-6	1"	102	251,50
AR70-7	1 1/4"	120	291,00
AR70-8	1 1/2"	140	296,00
AR70-9	2"	169	442,75
AR70-10	2 1/2"	214	1153,75
AR70-11	3"	269	1498,75
AR70-12	4"	290	2277,50



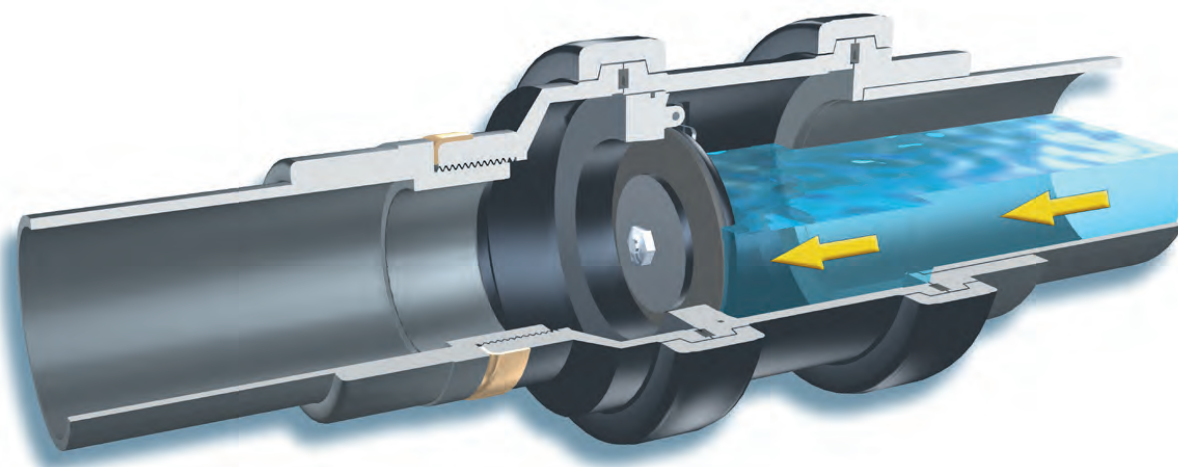
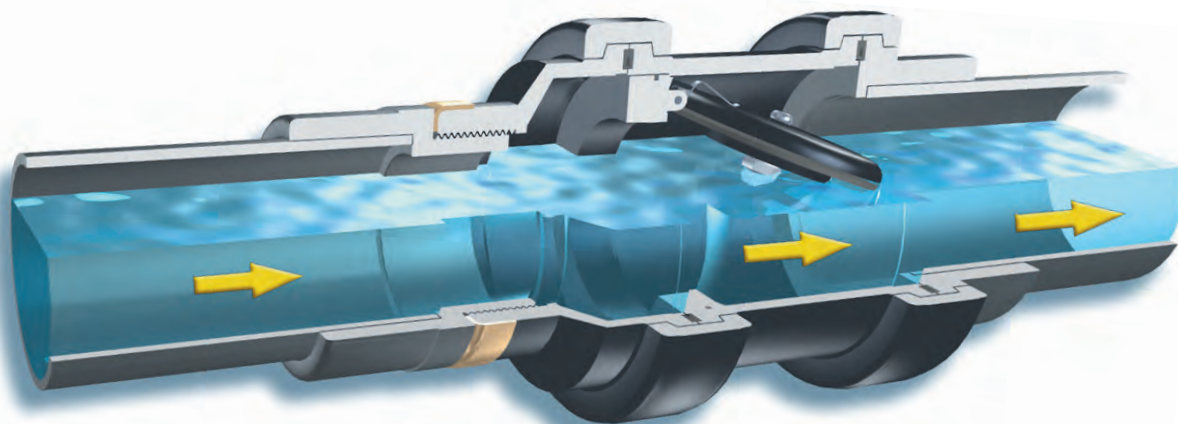

Kontraklapventil
U-PVC (POLYVINYLCHLORID)



Varenr.	ø	DN	DKK
AH19-1	90mm	80	1894,25
AH19-2	110mm	100	2116,75
AH19-3	125mm	110	2482,50
AH19-4	140mm	125	2939,75
AH19-5	160mm	150	3725,75
AH19-6	200/225mm	175	4969,75
AH19-7	250mm	225	7625,25

Kontraklapventil
U-PVC (POLYVINYLCHLORID)



Med fjeder retur			
Varenr.	ø	DN	DKK
AH20-1	90mm	80	2277,50
AH20-2	110mm	100	2537,00
AH20-3	125mm	110	2964,50
AH20-4	140mm	125	3522,75
AH20-5	160mm	150	4351,75
AH20-6	200/225mm	175	5687,75
AH20-7	250mm	225	8456,50

Kontraklapventil
U-PVC (POLYVINYLCHLORID)

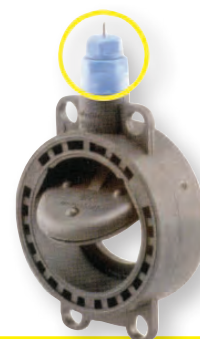

Med fjeder retur + pos.indikator			
Varenr.	ø	DN	DKK
AH21-1	90mm	80	2692,50
AH21-2	110mm	100	2927,50
AH21-3	125mm	110	3378,50
AH21-4	140mm	125	4140,75
AH21-5	160mm	150	4969,75
AH21-6	200/225mm	175	6325,25
AH21-7	250mm	225	9393,75

Kontraklapventil
U-PVC (POLYVINYLCHLORID)



Varenr.	ø	DN	DKK
AH28-40	40mm	32	344,50
AH28-50	50mm	40	367,75
AH28-63	63mm	50	435,50
AH28-75	75mm	65	480,50
AH28-90	90mm	80	568,75
AH28-110	110mm	100	698,00
AH28-125	125mm	110	749,50
AH28-140	140mm	125	801,00
AH28-160	160mm	150	982,75
AH28-200	200mm	200	1118,75
AH28-225	225mm	200	1165,00
AH28-250	250mm	225	2624,50
AH28-280	280mm	280	1828,25
AH28-315	315mm	315	2742,00

Flangesæt til lim
U-PVC (POLYVINYLCHLORID)



Varenr.	ø	O	DKK
AH22-1	75mm	8-ø18	587,00
AH22-2	90mm	8-ø18	587,00
AH22-3	110mm	8-ø18	772,50
AH22-4	125mm	8-ø18	954,25
AH22-5	140mm	8-ø18	1665,75
AH22-6	160mm	8-ø22	1748,00
AH22-7	200mm	8-ø22	1931,25
AH22-8	225mm	8-ø22	1931,25
AH22-9	250mm	12-ø22	5966,00

Flangesæt muf/muf
U-PVC (POLYVINYLCHLORID) - BSPP



Varenr.	BSPP	O	DKK
AH23-10	2 1/2"	8-ø18	606,00
AH23-11	3"	8-ø18	606,00
AH23-12	4"	8-ø18	740,00
AH23-13	5"	8-ø18	1075,50
AH23-14	6"	8-ø22	1760,50
AH23-15	8"	8-ø22	2587,50
AH23-16	10"	12-ø22	5966,00



SIKKERHEDSVENTILER



Sikkerhedsventil 90° muf/muf MESSING - BSPT



Varenr.	BSPP	BAR	DKK
E411-4-15	1/2"	1,5	201,75
E411-4-20	1/2"	2	201,75
E411-4-25	1/2"	2,5	201,75
E411-4-30	1/2"	3	201,75
E411-4-40	1/2"	4	201,75
E411-4-60	1/2"	6	201,75
E411-5-15	3/4"	1,5	201,75
E411-5-20	3/4"	2	201,75
E411-5-25	3/4"	2,5	201,75
E411-5-30	3/4"	3	201,75
E411-5-40	3/4"	4	201,75
E411-5-60	3/4"	6	201,75

Sikkerhedsventil 90° nip/muf MESSING - BSPT



PED godkendt. Max. 90°C

Varenr.	BSPT × BSPP	BAR	DKK
E412-4-15	1/2"	1,5	159,75
E412-4-20	1/2"	2	155,00
E412-4-25	1/2"	2,5	159,75
E412-4-30	1/2"	3	159,75
E412-4-40	1/2"	4	159,75
E412-4-60	1/2"	6	159,75

Sikkerhedsventil 90° muf/muf MESSING - BSPT



PED godkendt. Max. 90°C

Med manometer

Varenr.	BSPP	BAR	DKK
E413-4-15	1/2"	1,5	257,50
E413-4-20	1/2"	2	257,50
E413-4-25	1/2"	2,5	257,50
E413-4-30	1/2"	3	257,50
E413-4-40	1/2"	4	257,50
E413-4-60	1/2"	6	257,50

Sikkerhedsventil 90° nip/muf MESSING - BSPT



PED godkendt. Max. 90°C

Med manometer

Varenr.	BSPT × BSPP	BAR	DKK
E414-4-15	1/2"	1,5	268,00
E414-4-20	1/2"	2	260,00
E414-4-25	1/2"	2,5	268,00
E414-4-30	1/2"	3	268,00
E414-4-40	1/2"	4	268,00
E414-4-60	1/2"	6	268,00

Sikkerhedsventil 90° studs/nip PA (POLYAMID) - BSPP



Sikrer at overløb fra trykbeholder returneres til beholderen, uden manuel indgriben. Krop: fiberforstærket nylon.

Interne dele: PP.

Pakninger: VITON

Varenr.	BSPP	BAR	DKK
A328-1	3/8"	10	205,50
A328-2	3/8"	20	205,50
A328-3	3/8"	30	205,50
A328-4	3/8"	40	205,50
A328-5	3/8"	50	205,50
A328-6	1/2"	10	205,50
A328-7	1/2"	20	205,50
A328-8	1/2"	40	205,50
A328-9	1/2"	50	205,50
A328-10	3/4"	10	205,50
A328-11	3/4"	20	205,50

MAGNETVENTILER



Afhængig af type magnet-ventil



Se hver type



En serie magnetventiler i hhv. messing og rustfri syrefast stål AISI 316.

Desuden er der en specialventil, hvor hele kroppen er lavet af teflon, decideret beregnet til flydende / tynd syre og alkaliske væsker.

Magnetventil direkte

MESSING - BSPP



-10° til +90°C. Direkte styret. Installeres horisontalt. Medie: luft, vand, let olie, vacuum.

Normalt lukket

Varenr.	dim	L	Max. BAR	S	DKK
EO20-1	1/8"	1,5	8,5	Ø9	278,00
EO20-2	1/4"	2,3	8,5	Ø9	278,00
EO20-3	3/8"	8	8,5	Ø15	511,50
EO20-4	1/2"	13	7	Ø15	511,50
EO20-5	3/4"	20	7	Ø15	771,50
EO20-6	1"	25	7	Ø15	1006,00
EO20-8	1 1/2"	40	5	Ø20	2649,25

L = lysning, S = spindel

Magnetventil pilot

MESSING - BSPP



-10° til +90°C. Pilotstyret, min. 0,5bar differensstryk. Installeres horisontalt. Medie: luft, vand, neutral gas, mineralsk olie.

Normalt lukket

Varenr.	dim	L	BAR	S	DKK
EO21-3	3/8"	13	0,5-10	Ø15	612,50
EO21-4	1/2"	13	0,5-10	Ø15	612,50
EO21-5	3/4"	25	0,5-10	Ø15	1006,00
EO21-6	1"	25	0,5-10	Ø15	1006,00
EO21-7	1 1/4"	38	0,5-10	Ø15	1808,75
EO21-8	1 1/2"	38	0,5-10	Ø15	1808,75
EO21-9	2"	50	0,5-10	Ø15	3838,00

L = lysning, S = spindel

Magnetventil pilot

MESSING - BSPP



-10° til +180°C. Pilotstyret, min. 0,5bar differensstryk. Installeres horisontalt. Medie: damp, luft og varmt vand.

Normalt lukket

Varenr.	dim	L	BAR	S	DKK
EO24-3	3/8"	13	0,5-10	Ø15	923,75
EO24-4	1/2"	13	0,5-10	Ø15	923,75
EO24-5	3/4"	25	0,5-10	Ø15	1004,25
EO24-6	1"	25	0,5-10	Ø15	1004,25
EO24-7	1 1/4"	40	0,5-10	Ø15	4282,75
EO24-8	1 1/2"	40	0,5-10	Ø15	4282,75
EO24-9	2"	50	0,5-10	Ø15	5213,00

L = lysning, S = spindel

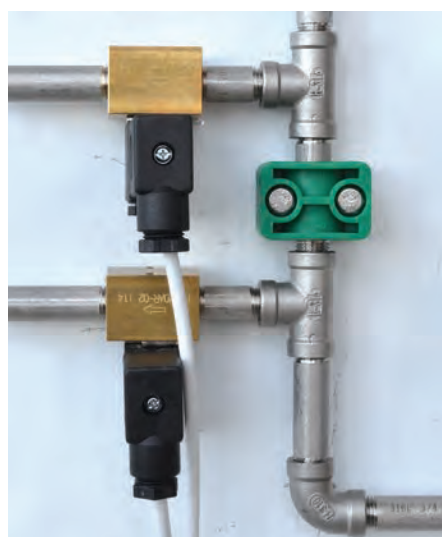

207

Højtryk magnetventil pilot

MESSING - BSPP



-10° til +90°C. Pilotstyret, min 0,5 - max 50bar. Installeres horisontalt.
Medie: luft, vand, neutral gas, mineralsk olie.

Normalt lukket

Varenr.	dim	L	BAR	S	DKK
EO30-3	3/8"	13	0,5-50	Ø15	2025,00
EO30-4	1/2"	13	0,5-50	Ø15	2025,00
EO30-5	3/4"	25	0,5-50	Ø15	2228,00
EO30-6	1"	25	0,5-50	Ø15	2228,00

L = lysning, S = spindel

Magnetventil pilot

AISI 316 - BSPP



-10° til +90°C. Pilotstyret, min. 0,5bar differenstryk. Installeres horisontalt.
Medie: luft, vand, neutral gas, mineralsk olie, osmosevand.

Normalt lukket

Varenr.	dim	L	BAR	S	DKK
EO22-3	3/8"	13	0,5-10	Ø15	1436,00
EO22-4	1/2"	13	0,5-10	Ø15	1436,00
EO22-5	3/4"	25	0,5-10	Ø15	2153,75
EO22-6	1"	25	0,5-10	Ø15	2153,75
EO22-7	1 1/4"	38	0,5-10	Ø15	2871,75
EO22-8	1 1/2"	38	0,5-10	Ø15	2871,75
EO22-9	2"	50	0,5-10	Ø15	4766,00

L = lysning, S = spindel

Coil til magnetventil ø9/ø15



Varenr.	Volt	ø	Watt	DKK
EO27-1-9	220 AC	9	6VA	108,50
EO27-2-9	110 AC	9	6VA	108,50
EO27-3-9	24 DC	9	4,8W	108,50
EO27-4-9	48 AC	9	6VA	108,50
EO27-5-9	24 AC	9	6VA	108,50
EO27-6-9	12 DC	9	4,8W	108,50
EO27-7-9	12 AC	9	6VA	108,50

EO27-1	220 AC	15	22VA	262,25
EO27-2	110 AC	15	22VA	262,25
EO27-3	24 DC	15	15W	262,25
EO27-4	48 AC	15	22VA	262,25
EO27-5	24 AC	15	22VA	262,25
EO27-6	12 DC	15	15W	262,25
EO27-7	12 AC	15	22VA	262,25

EO20-1 + EO20-2 = ø9, alle andre = ø15

Magnetventil pilot

MESSING - BSPP

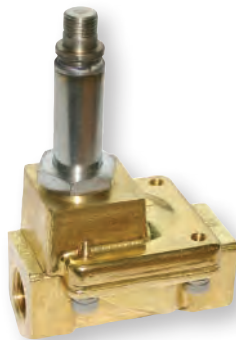

-10° til +90°C. Pilotstyret, min. 0,5bar differenstryk. Installeres horisontalt.
Medie: luft, vand, neutral gas, mineralsk olie.

Normalt åben

Varenr.	dim	L	BAR	S	DKK
EO21-3NO	3/8"	13	0,5-10	Ø15	612,50
EO21-4NO	1/2"	13	0,5-10	Ø15	612,50
EO21-5NO	3/4"	25	0,5-10	Ø15	1006,00
EO21-6NO	1"	25	0,5-10	Ø15	1006,00
EO21-7NO	1 1/4"	38	0,5-10	Ø15	1808,75
EO21-8NO	1 1/2"	38	0,5-10	Ø15	1808,75

L = lysning, S = spindel

Magnetventil pilot

AISI 316 - BSPP



-10° til +90°C. Pilotstyret, min. 0,5bar differenstryk. Installeres horisontalt.
Medie: luft, vand, neutral gas, mineralsk olie, osmosevand.

Normalt åben

Varenr.	dim	L	BAR	S	DKK
EO22-3NO	3/8"	13	0,5-10	Ø15	1370,00
EO22-4NO	1/2"	13	0,5-10	Ø15	1370,00
EO22-5NO	3/4"	25	0,5-10	Ø15	2055,00
EO22-6NO	1"	25	0,5-10	Ø15	2055,00
EO22-7NO	1 1/4"	38	0,5-10	Ø15	2740,00
EO22-8NO	1 1/2"	38	0,5-10	Ø15	2740,00
EO22-9NO	2"	50	0,5-10	Ø15	4547,50

L = lysning, S = spindel

Coil til magnetventil TERMOPLAST



Inkl. 3 meter kabel.

-20°C ~ +50°C

Bemærk: Kun til brug for magnetventiler, normalt lukket (NC).

Ex-proof

Varenr.	Volt	ø	Watt	DKK
EOEX27-1-9	220 AC	9	8,5VA	1075,50
EOEX27-3-9	24 DC	9	10W	1075,50
EOEX27-1	220 AC	15	8,5VA	2091,00
EOEX27-3	24 DC	15	10W	2091,00

Coil til magnetventil ø20



Varenr.	Volt	ø	DKK
EO27-1-20	220 AC	20	464,25 α
EO27-2-20-1	110 AC	20	464,25 α
EO27-3-20	24 DC	20	464,25

α = så længe lager haves

Tilslutning til 1/8" - 1/4"



Varenr.	ø	DKK
EO28-1-9	9	20,45

Tilslutning til 3/8" - 1"



Varenr.	ø	DKK
EO28-1	15	20,45

Magnetventil 230V AC

AISI 316 - BSPP



-5° til +185°C, 0-7 bar. Direkte styret.
VITON pakning.
Medie: damp, vand, luft.

Normalt lukket, inkl. coil

Varenr.	dim	Lysning	BAR	DKK
EO23-1	1/8"	2,5mm	0-7	643,75
EO23-2	1/4"	2,5mm	0-7	643,75

Magnetventil 24V DC

AISI 316 - BSPP



-5° til +185°C, 0-7 bar. Direkte styret.
VITON pakning.
Medie: damp, vand, luft.

Normalt lukket, inkl. coil

Varenr.	dim	Lysning	BAR	DKK
EO23-1-24V	1/8"	2,5mm	0-7	643,75
EO23-2-24V	1/4"	2,5mm	0-7	643,75

Magnetventil direkte

AISI 316 - BSPP



-10° til +85°C, 7 bar. Direkte styret.
Medie: luft, vand og mineralsk olie.

Normalt lukket

Varenr.	dim	Lysning	Pakning	DKK
EO29-3	3/8"	13mm	VITON	1826,25
EO29-3-B	3/8"	13mm	NBR	1826,25
EO29-3-E	3/8"	13mm	EPDM	1826,25
EO29-4	1/2"	13mm	VITON	2020,00
EO29-4-B	1/2"	13mm	NBR	2020,00
EO29-4-E	1/2"	13mm	EPDM	2020,00
EO29-5	3/4"	20mm	VITON	2764,75
EO29-5-B	3/4"	20mm	NBR	2764,75
EO29-5-E	3/4"	20mm	EPDM	2764,75

Magnetventil direkte

AISI 316 - BSPP



-10° til +90°C, 0-8 bar.
Direkte styret, normal lukket, VITON pakning. Medie: luft. Kan bruges til vand, ammoniak, vakuum

Inkl. coil og connector

Varenr.	BSPP	Volt	DKK
B33EL-4	1/2"	230VAC	1232,00
B33EL-4-1	1/2"	24VDC	1232,00

Magnetventil direkte

PTFE (TEFLON) - BSPP



Temp: -5° til +90°C
Direkte styret, hurtig reaktionstid.
Medie: Flydende/tynd syre og alkalisk væske.

Varenr.	dim	L	BAR	S	DKK
EO25-3	3/8"	5	0,1-1	Ø15	1825,25
EO25-4	1/2"	5	0,1-1	Ø15	1825,25

L = lysning, S = spindel

Pneumatisk ventil direkte

PTFE (TEFLON) - BSPP



Temp: -10° til +60°C

Direkte styret, hurtig reaktionstid.

Medie: Rent vand, syre og alkalisk væske.

Varenr.	dim	L	BAR	S	DKK
EV33-3	3/8"	8	1,5-9	Ø15	2868,75
EV33-4	1/2"	8	1,5-9	Ø15	2868,75

L = lysning, S = spindel

TIMER TIL MAGNETVENTIL

EGENSKABER:

Styring af magnetventils tidsintervaller

24-240V AC/DC 50/60Hz

DIN 43650 ISO-4400/6952

IP65 NEMA 4

Mulighed for reset

ANVENDELSE:

Automatisk aftapningsventil

Automatisk aftapning af kondensvand

Prøveudtag af gas eller væsker, lufttørring

Styring af sprinklersystemer

Styring af pneumatiske vibrationssystemer

f.eks. pulver siloer

Automatisk oliesmøring

TIDSINTERVAL: 0,5 - 10 sek

LUKKETIDSINTERVAL: 0,5 - 60 min

FORBRUG: 4 mA max

ARBEJDSTEMP: -10° til +50°C

BESKYTTELSE: IP65 NEMA 4

RESET/TEST: Manuel trykknop

Timer til magnetventil



Kun til Ø15 spindel

Varenr.	dim	DKK
EO26-1	Ø15	1298,00

LUFTSTYRINGSVENTILER



Arbejdstryk: 0.15~0.8MPa
Max tryk 1.2MPa



5°C til 50°C



Luftstyringsventiler, spolestyrede eller
luftstyrede. Produceret i aluminium.



Spoleventil type 3/2

ALUMINIUM - BSPP



Varenr.	Port+Exh	Type	Ø mm ²	DKK
EV1-1	3 · M5	1	10	290,25
EV1-2	3 · M5	2	10	433,75
EV1-3	3 · 1/8"	1	14	290,25
EV1-4	3 · 1/8"	2	14	433,75
EV1-5	3 · 1/4"	1	16	278,25
EV1-6	3 · 1/4"	2	16	417,50
EV1-7	3 · 3/8"	1	25	375,00
EV1-8	3 · 3/8"	2	25	562,25
EV1-9	3 · 1/2"	1	30	652,00
EV1-10	3 · 1/2"	2	30	978,50

Type 1: 3/2 EL Enkeltvirk. Fjeder retur

Type 2: 3/2 EL Dobbeltvirk.

Spoleventil type 5/2

ALUMINIUM - BSPP



Varenr.	Port+Exh	Type	Ø mm ²	DKK
EV2-1	5 · M5	16	10	290,25
EV2-2	5 · M5	17	10	426,50
EV2-6	5 · 1/8"	16	14	290,25
EV2-7	5 · 1/8"	17	14	426,50
EV2-11	3-1/4"+2-1/8"	16	16	278,25
EV2-12	3-1/4"+2-1/8"	17	16	426,50
EV2-16	3-3/8"+2-1/4"	16	25	375,00
EV2-17	3-3/8"+2-1/4"	17	25	522,25
EV2-21	5 · 1/2"	16	30	652,00
EV2-22	5 · 1/2"	17	30	914,25

Type 16: 5/2 EL Enkeltvirk.

Type 17: 5/2 EL Dobbeltvirk.

Spoleventil type 5/3

ALUMINIUM - BSPP



Varenr.	Port+Exh	Type	Ø mm ²	DKK
EV2-3	5 · M5	21	7	794,50
EV2-4	5 · M5	23	7	794,50
EV2-5	5 · M5	22	7	794,50
EV2-8	5 · 1/8"	21	12	794,50
EV2-9	5 · 1/8"	23	12	794,50
EV2-10	5 · 1/8"	22	12	794,50
EV2-13	3-1/4"+2-1/8"	21	12	737,50
EV2-14	3-1/4"+2-1/8"	23	12	737,50
EV2-15	3-1/4"+2-1/8"	22	12	737,50
EV2-18	3-3/8"+2-1/4"	21	18	1015,25
EV2-19	3-3/8"+2-1/4"	23	18	1015,25
EV2-20	3-3/8"+2-1/4"	22	18	1015,25
EV2-23	5 · 1/2"	21	30	1306,25
EV2-24	5 · 1/2"	23	30	1306,25
EV2-25	5 · 1/2"	22	30	1306,25

Type 21: 5/3 EL Dobbeltvirk. Luk type

Type 22: 5/3 EL Dobbeltvirk. Tryk type

Type 23: 5/3 EL Dobbeltvirk. Åben type

Spoleventil type Namur

ALUMINIUM - BSPP

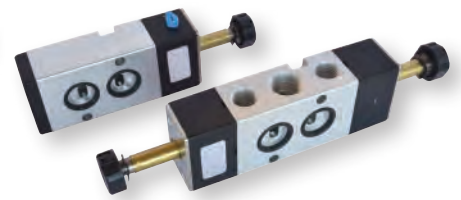

Varenr.	Port+Exh	Type	DKK
EV21-1	3 · 1/4"	16	402,00
EV21-2	1-3/8"+2-1/4"	16	402,00
EV21-3	3 · 1/4"	17	637,25
EV21-4	1-3/8"+2-1/4"	17	637,25
EV21-5	3 · 1/4"	21	1156,75
EV21-6	3 · 1/4"	23	1156,75
EV21-7	3 · 1/4"	22	1156,75
EV21-8	1-3/8"+2-1/4"	21	1156,75
EV21-9	1-3/8"+2-1/4"	23	1156,75
EV21-10	1-3/8"+2-1/4"	22	1156,75

Type 16: 5/2 EL Enkeltvirk.

Type 17: 5/2 EL Dobbeltvirk.

Type 21: 5/3 EL Dobbeltvirk. Luk type

Type 22: 5/3 EL Dobbeltvirk. Tryk type

Type 23: 5/3 EL Dobbeltvirk. Åben type

Coil+conn. m. LED til EV1/EV2



Varenr.	dim	Volt	DKK
EV5-1	M5	12 DC	135,75
EV5-2	M5	24 DC	135,75
EV5-3	M5	24 AC	135,75
EV5-4	M5	220 AC	135,75
EV5-5	M5	380 AC	135,75
EV5-6	1/8" - 1/2"	12 DC	135,75
EV5-7	1/8" - 1/2"	24 DC	135,75
EV5-8	1/8" - 1/2"	24 AC	135,75
EV5-9	1/8" - 1/2"	220 AC	135,75
EV5-10	1/8" - 1/2"	380 AC	135,75

Luftventil type 3/2

ALUMINIUM - BSPP



Varenr.	Port+Exh	Type	Ø mm ²	DKK
EV3-1	3 · M5	3	10	215,00
EV3-2	3 · M5	4	10	323,25
EV3-3	3 · 1/8"	3	14	215,00
EV3-4	3 · 1/8"	4	14	323,25
EV3-5	3 · 1/4"	3	16	198,50
EV3-6	3 · 1/4"	4	16	278,25
EV3-7	3 · 3/8"	3	25	261,50
EV3-8	3 · 3/8"	4	25	391,25
EV3-9	3 · 1/2"	3	30	431,50
EV3-10	3 · 1/2"	4	30	647,50

Type 3: 3/2 Luft Enkeltvirk. Fjeder retur

Type 4: 3/2 Luft Dobbeltvirk.

Luftventil type 5/2

ALUMINIUM - BSPP



Varenr.	Port+Exh	Type	Ø mm ²	DKK
EV4-1	5 · M5	10	10	215,00
EV4-2	5 · M5	11	10	273,00
EV4-6	5 · 1/8"	10	14	215,00
EV4-7	5 · 1/8"	11	14	273,00
EV4-11	3·1/4"+2·1/8"	10	16	198,50
EV4-12	3·1/4"+2·1/8"	11	16	278,25
EV4-16	3·3/8"+2·1/4"	10	25	261,50
EV4-17	3·3/8"+2·1/4"	11	25	330,50
EV4-21	5 · 1/2"	10	30	431,50
EV4-22	5 · 1/2"	11	30	562,25

Type 10: 5/2 Luft Enkeltvirk. Fjeder retur

Type 11: 5/2 Luft Dobbeltvirk.

Luftventil type 5/3

ALUMINIUM - BSPP



Varenr.	Port+Exh	Type	Ø mm ²	DKK
EV4-3	5 · M5	18	7	556,25
EV4-4	5 · M5	20	7	556,25
EV4-5	5 · M5	19	7	556,25
EV4-8	5 · 1/8"	18	12	556,25
EV4-9	5 · 1/8"	20	12	556,25
EV4-10	5 · 1/8"	19	12	556,25
EV4-13	3·1/4"+2·1/8"	18	12	562,25
EV4-14	3·1/4"+2·1/8"	20	12	562,25
EV4-15	3·1/4"+2·1/8"	19	12	562,25
EV4-18	3·3/8"+2·1/4"	18	18	652,00
EV4-19	3·3/8"+2·1/4"	20	18	652,00
EV4-20	3·3/8"+2·1/4"	19	18	652,00
EV4-23	5 · 1/2"	18	30	869,50
EV4-24	5 · 1/2"	20	30	869,50
EV4-25	5 · 1/2"	19	30	869,50

Type 18: 5/3 Luft Dobbeltvirk. Luk type

Type 19: 5/3 Luft Dobbeltvirk. Tryk type

Type 20: 5/3 Luft Dobbeltvirk. Åben type

Montageplade til EV2 + EV4

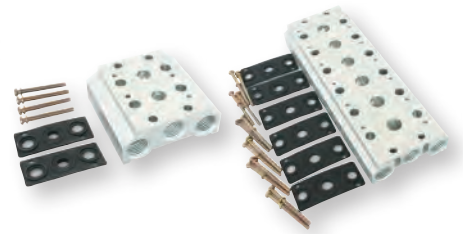

Passer ikke til M5

Varenr.	dim	Antal	L	DKK
EV6-1	1/4"	2	76mm	113,75
EV6-3	1/4"	4	114mm	227,00
EV6-4	1/4"	6	152mm	341,00
EV6-5	1/4"	8	190mm	454,25
EV6-6	1/4"	10	228mm	567,75
EV6-7	3/8"	2	110mm	169,75
EV6-8	3/8"	4	189mm	341,00
EV6-9	3/8"	6	222mm	511,25
EV6-10	3/8"	8	278mm	681,25
EV6-11	3/8"	10	334mm	852,50
EV6-12	1/2"	2	133mm	285,00
EV6-13	1/2"	4	203mm	567,75
EV6-14	1/2"	6	273mm	852,50
EV6-15	1/2"	8	343mm	1135,25
EV6-16	1/2"	10	413mm	1420,50

Blændplade til base



Varenr.	dim	DKK
EV6-91	M5	34,65
EV6-92	1/4"	34,65
EV6-93	3/8"	51,85
EV6-94	1/2"	69,10

Manuel ventil type 3/2

ALUMINIUM - BSPP



0-60°C, max 8bar.

Varenr.	Port+Exh	Type	DKK
EV11-1	3 · 1/8"	8	330,50
EV11-2	3 · 1/8"	6	330,50
EV11-3	3 · 1/4"	8	330,50
EV11-4	3 · 1/4"	6	330,50

Type 6: 

3/2 Manuel Lås

Type 8: 

3/2 Manuel Fjeder retur

Manuel ventil type 5/2

ALUMINIUM - BSPP



0-70°C, max 10bar.

UDEN møtrik og gevind i bunden af skaftet.

Varenr.	Port+Exh	Type	Ø mm	DKK
EV10-1	5 · 1/8"	15	14	313,00
EV10-2	5 · 1/8"	13	14	313,00
EV10-5	3-1/4"+2-1/8"	15	16	313,00
EV10-6	3-1/4"+2-1/8"	13	16	313,00
EV10-9	3-3/8"+2-1/4"	15	30	375,00
EV10-10	3-3/8"+2-1/4"	13	30	375,00
EV10-13	5 · 1/2"	15	50	652,00
EV10-14	5 · 1/2"	13	50	652,00

Type 13: 

5/2 Manuel Lås

Type 15: 

5/2 Manuel Fjeder retur

Manuel ventil type 4/3

ALUMINIUM - BSPP



0-60°C, max 8bar.

Varenr.	Port+Exh	DKK
EV12-1	4 · 1/4"	358,25
EV12-2	4 · 3/8"	358,25
EV12-3	4 · 1/2"	358,25

Manuel ventil

ALUMINIUM - BSPP



Varenr.	Port+Exh	Type	DKK
EV13-1	4 · 1/8"	2 pos/4 way	358,25
EV13-2	4 · 1/8"	3 pos/4 way	536,75
EV13-3	4 · 1/4"	2 pos/4 way	358,25
EV13-4	4 · 1/4"	3 pos/4 way	536,75

Type: 
4/2 og 4/3 vejs

Hurtigudlifter

ALUMINIUM - BSPP



5°C til 60°C, min 1,5bar, max 10bar.

Varenr.	Port+Exh	DKK
EV16-1	3 · 1/8"	130,50
EV16-2	2-1/4"+1-3/8"	148,50
EV16-3	3 · 3/8"	148,50
EV16-4	3 · 1/2"	238,25

Shuttleventil

ALUMINIUM - BSPP



5°C til 60°C, min 1,5bar, max 10bar.

Varenr.	Port+Exh	DKK
EV17-1	3 · 1/8"	113,75
EV17-2	3 · 1/4"	148,50

Manuel ventil type 5/2

ALUMINIUM - BSPP



0-60°C, max 8bar.

Varenr.	Port+Exh	Type	DKK
EV11-7	5 · 1/8"	15	338,50
EV11-8	5 · 1/8"	13	338,50
EV11-9	3-1/4"+2-1/8"	15	338,50
EV11-10	3-1/4"+2-1/8"	13	338,50

Type 13: 

5/2 Manuel Lås

Type 15: 

5/2 Manuel Fjeder retur

Manuel ventil type 5/3

ALUMINIUM - BSPP



0-70°C, max 10bar.

MED møtrik og gevind i bunden af skaftet.

Varenr.	Port+Exh	Type	Ø mm	DKK
EV10-3	5 · 1/8"	26	14	313,00
EV10-4	5 · 1/8"	25	14	313,00
EV10-7	3-1/4"+2-1/8"	26	12	313,00
EV10-8	3-1/4"+2-1/8"	25	12	313,00
EV10-11	3-3/8"+2-1/4"	26	18	375,00
EV10-12	3-3/8"+2-1/4"	25	18	375,00
EV10-15	5 · 1/2"	26	30	652,00
EV10-16	5 · 1/2"	25	30	652,00

Type 25: 

5/3 Manuel Lås Luk type

Type 26: 

5/3 Manuel Fjeder retur Luk type

Glideventil muf/muf

MESSING - BSPP



Varenr.	BSPP	DKK
E6060-1	1/8"	134,50
E6060-2	1/4"	166,25
E6060-3	3/8"	203,25
E6060-4	1/2"	256,25

-20° til +80°C. Min 0,3 bar, max 10

In-line regulator

ALUMINIUM



Temp: -10° til +60°C

Driftstryk: 2 - 8 bar

Max flow 650L/min

Varenr.	BSPP	DKK
E425-2	1/4"	480,50

Man/mek. ventil type 3/2

ALUMINIUM - BSPP



EV14-1 EV14-2 EV14-3 EV14-4



EV14-5 EV14-6 EV14-7 EV14-8

Ø 12mm²

Varenr.	Port+Exh	Type	DKK
EV14-1	3 · 1/8"	8	313,00
EV14-2	3 · 1/8"	8	313,00
EV14-3	3 · 1/8"	8	313,00
EV14-4	3 · 1/8"	8	313,00
EV14-5	3 · 1/8"	8	313,00
EV14-6	3 · 1/8"	8	313,00
EV14-7	3 · 1/8"	8	313,00
EV14-8	3 · 1/8"	7	313,00

Type 7: 3/2 Mekanisk Fjeder retur

Type 8: 3/2 Manuel Fjeder retur

Man/mek. ventil type 3/2

ALUMINIUM - BSPP



EV14-11 EV14-12 EV14-13 EV14-14



EV14-15 EV14-16 EV14-17 EV14-18

Ø 16mm²

Varenr.	Port+Exh	Type	DKK
EV14-11	3 · 1/4"	8	313,00
EV14-12	3 · 1/4"	8	313,00
EV14-13	3 · 1/4"	8	313,00
EV14-14	3 · 1/4"	8	313,00
EV14-15	3 · 1/4"	8	313,00
EV14-16	3 · 1/4"	8	313,00
EV14-17	3 · 1/4"	8	313,00
EV14-18	3 · 1/4"	7	313,00

Type 7: 3/2 Mekanisk Fjeder retur

Type 8: 3/2 Manuel Fjeder retur

Man/mek. ventil type 5/2

ALUMINIUM - BSPP



EV14-21 EV14-22 EV14-23 EV14-24



EV14-25 EV14-26 EV14-27 EV14-28

Ø 16mm²

Varenr.	Port+Exh	Type	DKK
EV14-21	3·1/4" + 2·1/8"	15	330,50
EV14-22	3·1/4" + 2·1/8"	15	330,50
EV14-23	3·1/4" + 2·1/8"	15	330,50
EV14-24	3·1/4" + 2·1/8"	15	330,50
EV14-25	3·1/4" + 2·1/8"	15	330,50
EV14-26	3·1/4" + 2·1/8"	15	330,50
EV14-27	3·1/4" + 2·1/8"	15	330,50
EV14-28	3·1/4" + 2·1/8"	14	330,50

Type 14:

5/2 Mekanisk Fjeder retur

Type 15:

5/2 Manuel Fjeder retur

Mekanisk ventil type 3/2

ALUMINIUM - BSPP



Varenr.	Port+Exh	Type	Ø mm ²	DKK
EV15-10	3 · 1/8"	6	14	227,00
EV15-11	3 · 1/4"	6	16	227,00

Type 6:

3/2 Manuel Lås

Mekanisk ventil type 5/2

ALUMINIUM - BSPP



Varenr.	Port+Exh	Type	Ø mm ²	DKK
EV15-1	5 · 1/8"	13	14	233,50
EV15-2	3·1/4" + 2·1/8"	13	16	233,50

Type 13:

5/2 Manuel Lås

Fodventil type 3/2 + 4/2

ALUMINIUM - BSPP



Varenr.	Port+Exh	Type	DKK
EV18-1	2·1/4" + 1·1/8"	7	381,50
EV19-1	3·1/4" + 1·1/8"	9	403,25

Type 7:

3/2 Mekanisk Fjeder retur

Type 9:

4/2 Mekanisk Fjeder retur

Fodventil type 5/2 m. dæksel

ALUMINIUM - BSPP



Varenr.	Port+Exh	Type	DKK
EV20-1	5 · 1/4"	15	624,25

Type 15:

5/2 Manuel Fjeder retur

Trykluftolie

RANDO HD32



Rando HD anbefales til brug i alle typer højtydende industrielle og mobile hydrauliske systemer, der arbejder under moderate omgivelsestemperaturer, høje tryk og pumpehastigheder.

Varenr.	L	DKK
S1010-1	1	156,25
S1010-2	2,5	364,25

KUGLEHANER PNEUMATISKE RUSTFRI AISI 316



Arbejdsstryk: (CWP):
1000 psi (PN 63 bar)



-20° til +180°C



DIN 3202 M3, DIN 3202 S13
DIN 3202 F1





Rustfri syrefast stål AISI 316 pneumatisk styrede kuglehaner med fuld gennemløb. Antistatisk design. Aktuator monteret direkte på ventil med udskydningssikret aksel.

Bruges typisk med en NAMUR ventil.

VENTILSPECIFIKATIONER:

- Krop: ASTM A351 GR.CF8M (EN10213-4 1.4408)
- Kugle: AISI 316
- Aksel: AISI 316
- Sæde: PTFE
- Tilslutning: gevind-ender
- Aktuator: luftstyret: 1/4"
- Lukketryk: 80 psi=5,5 bar

Type 16:  5/2 EL Enkeltvirk.

Type 17:  5/2 EL Dobbeltvirk.

Type 21:  5/3 EL Dobbeltvirk. Luk type

Type 22:  5/3 EL Dobbeltvirk. Tryk type

Type 23:  5/3 EL Dobbeltvirk. Åben type

Pneumatisk ventil SA

AISI 316 - BSPP



Pneumatisk ventil DA

AISI 316 - BSPP



Spoleventil type Namur

ALUMINIUM - BSPP

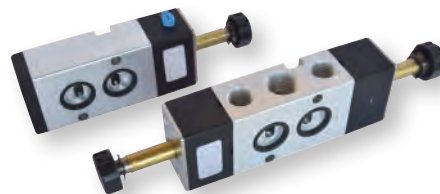

Enkeltvirkende

Varenr.	BSPP	DKK
B33-22ACSR	1/4"	2750,25
B33-23ACSR	3/8"	2750,25
B33-24ACSR	1/2"	3030,50
B33-25ACSR	3/4"	3090,00
B33-26ACSR	1"	3764,75
B33-27ACSR	1 1/4"	4086,25
B33-28ACSR	1 1/2"	4480,50
B33-29ACSR	2"	5196,50
B33-30ACSR	2 1/2"	8688,25
B33-31ACSR	3"	10542,25
B33-32ACSR	4"	12900,75

Dobbeltvirkende

Varenr.	BSPP	DKK
B33-22ACDA	1/4"	1919,00
B33-23ACDA	3/8"	2106,50
B33-24ACDA	1/2"	2106,50
B33-25ACDA	3/4"	2173,50
B33-26ACDA	1"	2938,75
B33-27ACDA	1 1/4"	2962,50
B33-28ACDA	1 1/2"	3618,50
B33-29ACDA	2"	4098,50
B33-30ACDA	2 1/2"	6780,50
B33-31ACDA	3"	8322,50
B33-32ACDA	4"	13318,00

Varenr.	Port+Exh	Type	DKK
EV21-1	3 · 1/4"	16	402,00
EV21-2	1-3/8"+2-1/4"	16	402,00
EV21-3	3 · 1/4"	17	637,25
EV21-4	1-3/8"+2-1/4"	17	637,25
EV21-5	3 · 1/4"	21	1156,75
EV21-6	3 · 1/4"	23	1156,75
EV21-7	3 · 1/4"	22	1156,75
EV21-8	1-3/8"+2-1/4"	21	1156,75
EV21-9	1-3/8"+2-1/4"	23	1156,75
EV21-10	1-3/8"+2-1/4"	22	1156,75

Illustration



Illustration



Coil+conn. m. LED til EV1/EV2



Varenr.	dim	Volt	DKK
EV5-1	M5	12 DC	135,75
EV5-2	M5	24 DC	135,75
EV5-3	M5	24 AC	135,75
EV5-4	M5	220 AC	135,75
EV5-5	M5	380 AC	135,75
EV5-6	1/8" - 1/2"	12 DC	135,75
EV5-7	1/8" - 1/2"	24 DC	135,75
EV5-8	1/8" - 1/2"	24 AC	135,75
EV5-9	1/8" - 1/2"	220 AC	135,75
EV5-10	1/8" - 1/2"	380 AC	135,75

KUGLEHNER EL-STYREDE RUSTFRI AISI 316



Arbejdstryk: (CWP):
1000 psi (PN 63 bar)



-20°C til +180°C



DIN 3202 M3, DIN 3202 S13
DIN 3202 F1, IP Klasse 67



Rustfri stål AISI 316 el-styrede kuglehane ventiler med direkte monteret aktuator og fuldt gennemløb. Antistatisk design. Aktuator monteret direkte på ventil med udskydningsikret aksel. 220V AC eller 24V DC.

VENTILSPECIFIKATIONER:

- Krop: ASTM A351 GR.CF8M (EN10213-4 1.4408)
- Kugle: AISI 316
- Aksel: AISI 316
- Sæde: PTFE
- Tilslutning: gevind-ender
- Aktuator: IP klasse 67



Kuglehane 2-delt 230V AC
AISI 316 - BSPP

Kuglehane 2-delt 24V DC
AISI 316 - BSPP



Varenr.	BSPP	DKK
B33-24EL-7	1/2"	2965,50
B33-25EL-7	3/4"	3041,75
B33-26EL-7	1"	3307,50
B33-27EL-7	1 1/4"	3609,25
B33-28EL-7	1 1/2"	4072,75

Varenr.	BSPP	DKK
B33-24EL-2	1/2"	2965,50
B33-25EL-2	3/4"	3041,75
B33-26EL-2	1"	3307,50
B33-27EL-2	1 1/4"	3609,25
B33-28EL-2	1 1/2"	4072,75

Kuglehane 3-delt 230V AC

AISI 316 - BSPP



Varenr.	BSPP	Watt	DKK
B33-22EL	1/4"	3-4W	3752,50
B33-23EL	3/8"	3-4W	3752,50
B33-24EL	1/2"	3-4W	4128,25
B33-25EL	3/4"	3-4W	4207,75
B33-26EL	1"	3-4W	4499,25
B33-27EL	1 1/4"	3-4W	4839,00
B33-28EL	1 1/2"	10W	5294,50
B33-29EL	2"	10W	10598,75
B33-30EL	2 1/2"	25W	11695,75
B33-31EL	3"	25W	12550,75
B33-32EL	4"	25W	16145,25

Kuglehane 3-vejs T 230V AC

AISI 316 - BSPP



Varenr.	BSPP	DKK
B33-24EL-5	1/2"	3440,25
B33-25EL-5	3/4"	3580,50
B33-26EL-5	1"	4101,50
B33-27EL-5	1 1/4"	6093,50
B33-28EL-5	1 1/2"	6998,00

Kuglehane 3-vejs L 230V AC

AISI 316 - BSPP



Varenr.	BSPP	DKK
B33-24EL-6	1/2"	3440,25
B33-25EL-6	3/4"	3580,50
B33-26EL-6	1"	4101,50
B33-27EL-6	1 1/4"	6093,50
B33-28EL-6	1 1/2"	6998,00

Kuglehane 3-delt 24V DC

AISI 316 - BSPP



Varenr.	BSPP	Watt	DKK
B33-22EL-1	1/4"	3-4W	3752,50
B33-23EL-1	3/8"	3-4W	3752,50
B33-24EL-1	1/2"	3-4W	4128,25
B33-25EL-1	3/4"	3-4W	4207,75
B33-26EL-1	1"	3-4W	4499,25
B33-27EL-1	1 1/4"	3-4W	4401,25
B33-28EL-1	1 1/2"	10W	5293,25
B33-29EL-1	2"	10W	9641,00
B33-30EL-1	2 1/2"	25W	11695,75
B33-31EL-1	3"	25W	13802,00
B33-32EL-1	4"	25W	16145,25

Kuglehane 3-vejs T 24V DC

AISI 316 - BSPP



Varenr.	BSPP	DKK
B33-24EL-3	1/2"	3440,25
B33-25EL-3	3/4"	3580,50
B33-26EL-3	1"	4101,50
B33-27EL-3	1 1/4"	6093,50
B33-28EL-3	1 1/2"	6998,00

Kuglehane 3-vejs L 24V DC

AISI 316 - BSPP



Varenr.	BSPP	DKK
B33-24EL-4	1/2"	3440,25
B33-25EL-4	3/4"	3580,50
B33-26EL-4	1"	4101,50
B33-27EL-4	1 1/4"	6093,50
B33-28EL-4	1 1/2"	6998,00

VARERNE TIL TIDEN OG OGSÅ DE RIGTIGE VARER TIL TIDEN

Vi forsøger konstant at udvikle vores leveringer og med mere end 1.600.000 fittings på lager, kræver det god orden og styr på tingene.

Vi har igennem de sidste år gjort store investinger i at køre vores lager så effektivt som muligt.

Vi har på nuværende tidspunkt alle fittings, ventiler og ... liggende inde i vores automatiske lagersystem, der rummer mere end 80.000 kasser med fittings.

Lad os hjælpe dig med få tingene til tiden, så du slipper for at bruge tid på restordre og lignende.

Hvis vi ved, hvad og hvor meget, du skal bruge, sikrer vi, at dine fittings konstant er på lager, således du ikke løber tør i din produktion eller til dit projekt.



PNEUMATVENTILER SKRÅ RUSTFRI AISI 316



Max 16bar



-10° til +150°C



FORDELE VED SKRÅ SÆDEVENTILER

- stor gennemstrømning, lav modstand, ingen banken i rørene. Det skrå sæde forbedrer gennemstrømningen med op til 30%
- super levetid, nærmest uforgængelige materialer
- avanceret pilot cylinder i rustfri stål, som holder til lidt af hvert. Selvmørende og frit drejelig 360°

Lufttilslutning: 1/8" med 3 - 8bar tryk.
Medie: vand, damp, gas og aggressiv væske

KAN BRUGES TIL:

- drikkevare automation
- tekstil tryk og farvning
- skumningsudstyr
- gas industri

- farmaceutisk og medicinsk udstyr
- gummi maskineri
- organisk og uorganisk kemisk industri
- desinfektion
- vand/spildevand

Sædeventil skrå NC

AISI 316 - BSPP



Sædeventil skrå DA

AISI 316 - BSPP



Sædeventil skrå NO

AISI 316 - BSPP



Normalt lukket, fjeder retur

Varenr.	BSPP	Kv(m ³ /h)	DKK
B33AIR-3	3/8"	3,8	1555,25
B33AIR-4	1/2"	4,7	1555,25
B33AIR-5	3/4"	9,5	2214,50
B33AIR-6	1"	18,1	2518,00
B33AIR-7	1 1/4"	23,1	3047,25
B33AIR-8	1 1/2"	32,9	3727,50
B33AIR-9	2"	52,8	4547,75

Varenr.	BSPP	Kv(m ³ /h)	DKK
B33AIR-D3	3/8"	3,8	1555,25
B33AIR-D4	1/2"	4,7	1555,25
B33AIR-D5	3/4"	9,5	1652,75
B33AIR-D6	1"	18,1	2372,00
B33AIR-D7	1 1/4"	23,1	3047,25
B33AIR-D8	1 1/2"	32,9	3165,75
B33AIR-D9	2"	52,8	3761,25

Normalt åben, fjeder retur

Varenr.	BSPP	Kv(m ³ /h)	DKK
B33AIR-O3	3/8"	3,8	1555,25
B33AIR-O4	1/2"	4,7	1555,25
B33AIR-O5	3/4"	9,5	1652,75
B33AIR-O6	1"	18,1	2372,00
B33AIR-O7	1 1/4"	23,1	3047,25
B33AIR-O8	1 1/2"	32,9	3165,75
B33AIR-O9	2"	52,8	3761,25

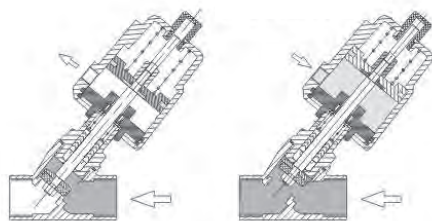

Enkelt virkende

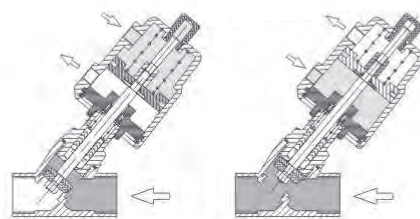

Dobbelt virkende

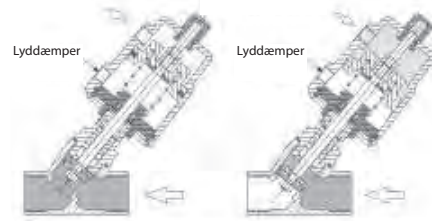

Indgang over sædet

Sædeventil pakning PTFE (TEFLON)

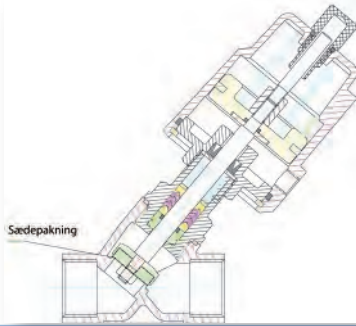

Varenr.	dim	DKK
B33AIR-3-SEAT	3/8"	45,35
B33AIR-4-SEAT	1/2"	45,35
B33AIR-5-SEAT	3/4"	75,40
B33AIR-6-SEAT	1"	136,25
B33AIR-7-SEAT	1 1/4"	227,25
B33AIR-8-SEAT	1 1/2"	287,75
B33AIR-9-SEAT	2"	413,00

Sædeventil kompakt NC AISI 316 - BSPP



Normalt lukket, fjeder retur

Varenr.	BSPP	DKK
B33AIR-4C	1/2"	1369,25

Sædeventil kompakt NC AISI 316 - BSPP



Normalt lukket, fjeder retur

Varenr.	BSPP	DKK
B33AIR-4V	1/2"	1369,25

Sædeventil kompakt DA AISI 316 - BSPP



Varenr.	BSPP	DKK
B33AIR-D4C	1/2"	1369,25

Sædeventil kompakt DA AISI 316 - BSPP



Varenr.	BSPP	DKK
B33AIR-D4V	1/2"	1369,25



Pneumatikventil DA AISI 316 - BSPP



Varenr.	BSPP	Dyrkrør	Cylinder	DKK
B33AIR-L1	1/2"	Ø 20 / L 112	Ø 27	1642,25
B33AIR-L2	1/2"	Ø 14 / L 150	Ø 27	1953,00
B33AIR-L3	1/2"	Ø 16 / L 265	Ø 32	2635,50

Pneumatikventil fordeler AISI 316 / PTFE (TEFLON) - BSPP



Dobbeltvirkende. Temp: -10° til +200°C.
Kontroltryk: 3-8 bar, væsketryk: 0-16 bar.
Til: vand, olie, luft.

Varenr.	BSPP	DKK
B33AIR-M4	1/2"	1694,75
B33AIR-M6	1"	1795,50

PNEUMATVENTILER LIGE RUSTFRI AISI 316



FORDELE VED LIGE SÆDEVENTILER

- kompakt størrelse og langtids holdbar
- hurtig reaktion, lavt tryk
- perfekt forsejling, kan arbejde i vaccum 740mmHg (relativt vaccum)
- fleksibel: nem at skille og ændre mellem de 3 arbejdsmetoder: normalt lukket, dobbeltvirkende og normalt åben

Lufttilslutning: 1/8" med 3 - 8bar tryk.
Medie: vand, damp, gas og aggressiv væske.

KAN BRUGES TIL:

- gas industri
- vacuum applikationer
- tekstil tryk og farvning

- farmaceutisk og medicinsk udstyr
- gummi maskineri
- organisk og uorganisk kemisk industri
- vaskeri, desinfektion
- vand/spildevand

Sædeventil lige NC

AISI 316 - BSPP



Varenr.	BSPP	DKK
B33AIR-V3	3/8"	2194,50
B33AIR-V4	1/2"	2459,25
B33AIR-V5	3/4"	2947,50
B33AIR-V6	1"	3390,50
B33AIR-V7	1 1/4"	3992,25
B33AIR-V8	1 1/2"	4527,75
B33AIR-V9	2"	5288,00

Sædeventil lige DA

AISI 316 - BSPP



Varenr.	BSPP	DKK
B33AIR-VD3	3/8"	2194,50
B33AIR-VD4	1/2"	2459,25
B33AIR-VD5	3/4"	2947,50
B33AIR-VD6	1"	3390,50
B33AIR-VD7	1 1/4"	3992,25
B33AIR-VD8	1 1/2"	4527,75
B33AIR-VD9	2"	5288,00

Sædeventil lige NO

AISI 316 - BSPP



Varenr.	BSPP	DKK
B33AIR-VO3	3/8"	2194,50
B33AIR-VO4	1/2"	2459,25
B33AIR-VO5	3/4"	2947,50
B33AIR-VO6	1"	3390,50
B33AIR-VO7	1 1/4"	3992,25
B33AIR-VO8	1 1/2"	4527,75
B33AIR-VO9	2"	5288,00

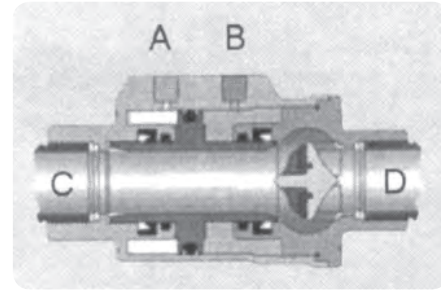
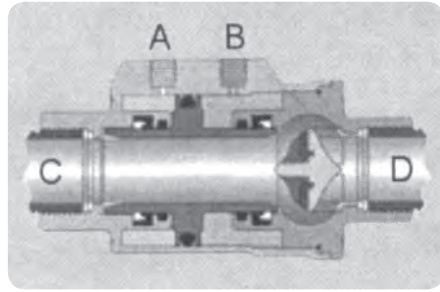
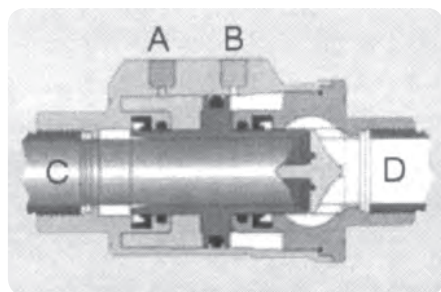

VIBRATIONS DÆMPERE & MASKINFØDDER



792 VIBRATIONS DÆMPERE
CYLINDRISKE



794 BUFFERE OG
STOPKLODSE



796 DIVERSE
DÆMPERE



797 ANTI-VIBRATIONS
BØSNINGER



798 SIKREDE OG MARINE
SVINGNINGS DÆMPERE



800 DÆMPERE MED
FLANGE



801 SANDWICH
DÆMPERE



802 MASKINSKO



803 HVAC & LOFT-
OPHÆNGTE DÆMPERE

VIBRATIONSDÆMPERE CYLINDRISKE



Vibrationsdæmpere anvendes for at reducere vibrationer fra maskiner, produktionsapparater eller som underlag, styring og afstandsholder for mekaniske dele. Eksempelvis justerbare møbler, sygepleje- og mobilitetsudstyr, have-, landbrugs- og rengøringsmaskiner er dæmpere og buffere af gummi en både oplagt løsning.

Læs mere om de forskellige typer under hvert emne. Er du i tvivl om hvilken vibrationsdæmper, der passer bedst til dine behov? Så er du meget velkommen til at kontakte kundeservice på telefon 75 945 955.

Vibrationsdæmpere er den ideelle løsning til at reducere støj, resonans eller stødpåvirkninger i produktionsanlæg.

Vibrationsdæmper nippel/nippel

STÅL / GUMMI

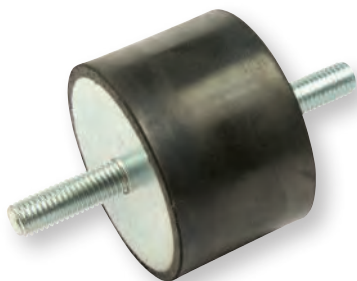

Enkel, effektiv og økonomisk, vibrationsdæmper er den ideelle løsning til at reducere stød og vibrationer.

Dens alsidighed, kvalitet og tilpasnings-evne betyder, at den type er en af de bedst sælgende vibrationsdæmpende produkter på markedet i dag.

Varenr.	D × H	V × I	DKK	AV1-16	50x25	M10x25	45,85
AV1-1	08x08	M3x06	10,05	AV1-17	50x30	M10x28	47,65
AV1-2	15x15	M3x15	10,05	AV1-18	50x35	M10x25	53,35
AV1-3	20x15	M6x18	11,60	AV1-19	50x40	M10x25	55,65
AV1-4	20x20	M6x18	12,65	AV1-20	50x50	M10x25	62,35
AV1-5	25x15	M6x18	15,45	AV1-21	60x25	M10x25	74,95
AV1-6	25x20	M8x20	15,75	AV1-22	60x35	M10x25	82,15
AV1-7	25x25	M6x18	17,00	AV1-23	70x45	M10x25	117,25
AV1-8	30x15	M8x20	20,90	AV1-24	75x35	M12x37	111,50
AV1-9	30x20	M8x20	21,65	AV1-25	75x50	M12x37	133,00
AV1-10	30x25	M8x20	23,45	AV1-26	75x55	M12x37	142,75
AV1-11	30x30	M8x20	25,75	AV1-27	100x30	M16x44	228,25
AV1-12	40x25	M10x25	32,20	AV1-28	100x60	M16x44	291,50
AV1-13	40x30	M10x25	34,55				
AV1-14	40x35	M10x25	36,60				
AV1-15	40x40	M10x25	38,40				

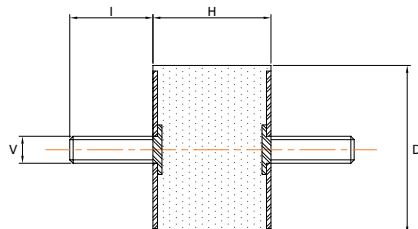

Vibrationsdæmper muffe/nippel STÅL / GUMMI



Varenr.	D × H	V × l	DKK
AV2-1	10x10	M4x06	10,85
AV2-2	15x15	M4x10	10,85
AV2-3	20x15	M6x18	12,65
AV2-4	20x20	M6x18	13,15
AV2-5	25x25	M6x18	18,05
AV2-6	30x15	M6x18	21,65
AV2-7	30x20	M8x20	23,45
AV2-8	30x25	M8x20	24,25
AV2-9	30x30	M8x20	26,80
AV2-10	50x30	M10x25	47,65
AV2-11	50x40	M10x25	55,65
AV2-12	50x50	M10x25	62,35
AV2-13	70x50	M12x37	149,50
AV2-14	75x25	M12x37	103,50
AV2-15	75x50	M12x37	136,50
AV2-16	100x60	M16x44	291,50

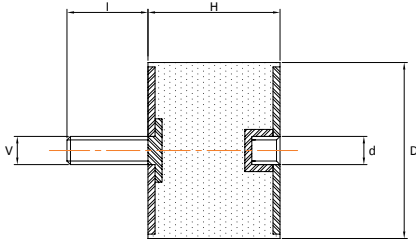

Vibrationsdæmper muffe/muffe STÅL / GUMMI



Vibrationsdæmpere er en billig løsning til vibrationsdæmpning og stød. De kan anvendes i enten kompression eller forskydning eller i en kombination, og fås med forskellige gevind konfigurationer.

Anvendelse:

Kan bruges i en lang række af applikationer og industrier, herunder dieselmotorer, generatoranlæg, instrumenter, industrielle maskiner og udstyr.

Vægtområde fra 1 kg til 2000 kg per montering.

Varenr.	D × H	d	DKK
AV3-1	20x25	M6	14,70
AV3-2	25x25	M6	18,55
AV3-3	30x30	M8	28,60
AV3-4	40x40	M8	38,65
AV3-5	50x40	M10	55,90
AV3-6	70x50	M12	153,25

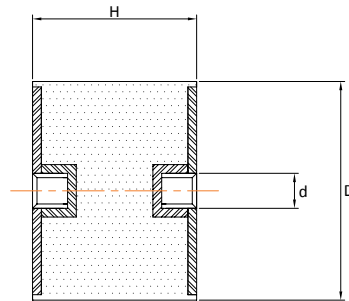

Vibrationsdæmper sekskant STÅL / GUMMI



Sekskantede endeplader muliggør en enkel montering og forhindrer spolerne i at vride under installationen. Kan de anvendes i kompression eller forskydning eller i en kombination.

Med en bred belastning på mellem 4 kg til 110 kg, typiske anvendelser omfatter:

Kontrolpaneler
Teknisk Udstyr
Elektronik

Varenr.	D × H	V × L	Shore A	DKK
AV4-1	16x16	M6x12	45	64,65
AV4-2	16x16	M6x12	60	64,65
AV4-3	21x19	M8x20	45	56,95
AV4-4	21x19	M8x20	60	56,95
AV4-5	32x26	M8x16	45	53,60
AV4-6	32x26	M8x16	60	53,60
AV4-7	33x22	M10x25	45	72,65
AV4-8	33x22	M10x25	60	72,65
AV4-9	43x25	M12x30	45	100,75
AV4-10	43x25	M12x30	60	100,75

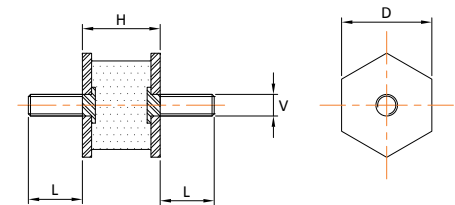

BUFFERE OG STOPKLODSE



Slidstærke buffere og stopklodser til reducere af skader på lastbiler og bygninger. Anvendes til dæmping af alle former for slag, stød og fald fra kraner, vogne, lukke- og stopanordninger m. fl.

Buffer nippel STÅL / GUMMI



Flade buffere er en økonomisk og enkel løsning på at absorbere stød og vibrationer.

Anvendelsesområder:

Byggeri
Landbrug
Erhvervskøretøj
Industrimaskiner

Disse kan også bruges som maskine fødder.

Buffer STÅL / GUMMI



Flade buffere er en økonomisk og enkel løsning på at absorbere stød og vibrationer.

Anvendelsesområder:

Byggeri
Landbrug
Erhvervskøretøj
Industrimaskiner

Disse kan også bruges som maskine fødder.

Buffer konisk STÅL / GUMMI



Konisk buffere er det ideelle produkt til absorbering for høje vibrationer og chok. Hvilket giver høje niveauer af deformation under påvirkning / belastning, og giver en progressiv stivhed rate til at absorbere energien og beskytte udstyret.

Anvendelsesområder:

Primær og sekundær suspension til køretøjer
Bump stopper for industrimaskiner

Varenr.	D × H	V × l	DKK
AV5-1	15x08	M4x10	8,50
AV5-2	20x12	M6x18	10,05
AV5-3	25x10	M8x20	11,10
AV5-4	30x15	M8x20	16,50
AV5-5	30x30	M8x20	21,15
AV5-6	40x40	M8x23	33,50
AV5-7	40x40	M10x25	33,50
AV5-8	50x21	M10x25	36,60
AV5-9	50x40	M10x25	47,15
AV5-10	100x30	M16x41	183,75

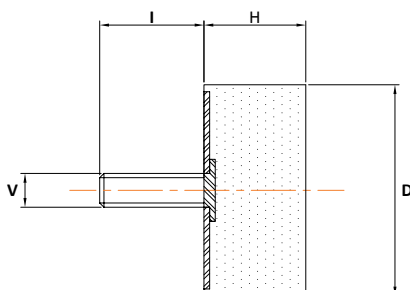

Varenr.	D × H	d	DKK
AV6-1	20x15	M6	10,05
AV6-2	30x15	M8	17,30
AV6-3	30x30	M8	21,90
AV6-4	50x21	M10	36,60

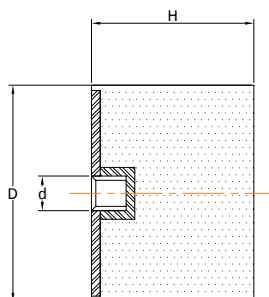

Varenr.	D × H	V × l	DKK
AV7-1	25x16	M6x18	39,70
AV7-2	30x30	M6x14	29,10
AV7-3	35x40	M8x23	32,20
AV7-4	50x50	M10x25	51,80
AV7-5	70x46	M12x30	290,50
AV7-6	95x80	M16x45	343,25
AV7-7	100x95	M12x31	357,25
AV7-8	100x120	M12x31	434,25

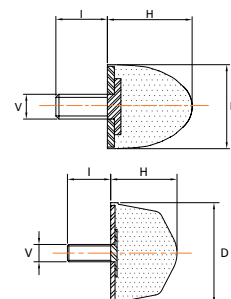

Buffer

STÅL / GUMMI



Plade buffere er et effektivt alternativ til at absorbere høje niveauer af chok og belastning. Det giver udstyret en fremragende beskyttelse. Den kraftige gummi og bløde stål flange med forborede skruehuller, tillader denne at være yderst alsidig.

Anvendelsesområder:

Byggeri

Landbrug

Erhvervskøretøj

Industrimaskiner

Varenr.	A x B x C	Max kg	DKK
AV8-1	121 x 57 x 56	4200	270,00

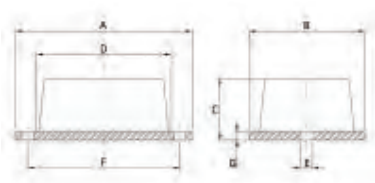

DIVERSE DÆMPERE



Vibrationsdæmper lavfrekvent STÅL / GUMMI

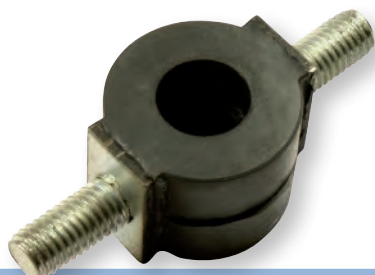

Varenr.	A x B	D x C	Shore A	DKK
AV9-1	17,0x14,0	M4x15	45	34,00
AV9-2	17,0x14,0	M4x15	60	34,00
AV9-3	19,3x29,6	M5x16	45	40,20
AV9-4	19,3x29,6	M5x16	60	40,20
AV9-5	25,5x38,2	M6x16	45	56,15
AV9-6	25,5x38,2	M6x16	60	56,15

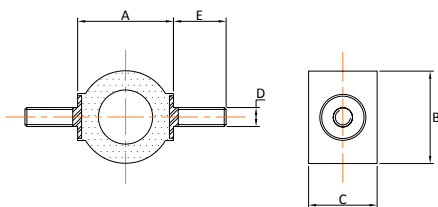

Vibrationsdæmper UU shear STÅL / GUMMI

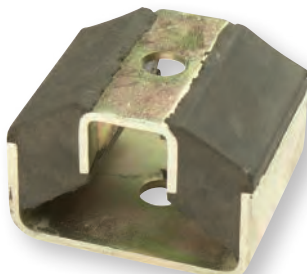

De egner sig til isolering af vibrationer fra maskiner med lave frekvenser og beskytter lette enheder mod stød og vibrationer.

Anvendelse:
Små generatore, blæsere og kompressorer, måle- og testinstrumenter.

Varenr.	A x B x C	Shore A	DKK
AV10-1	60x50x43	40	310,50
AV10-2	60x50x43	50	310,50
AV10-3	70x25x62	40	449,50
AV10-4	70x25x62	50	449,50
AV10-5	70x25x62	60	449,50
AV10-6	80x50x78	40	562,00
AV10-7	80x50x78	50	562,00
AV10-8	80x50x78	60	562,00
AV10-9	86x64x108	40	833,75
AV10-10	86x64x108	50	833,75
AV10-11	86x64x108	60	833,75

Vibration / støj maskinsko STÅL / GUMMI



Anvendelse:
Kontormaskiner, symaskiner, elmotorer og vægte.

Varenr.	Ø	Shore A	DKK
AV25-1	55	60	53,85
AV25-2	75	60	82,40
AV25-3	115	60	173,00

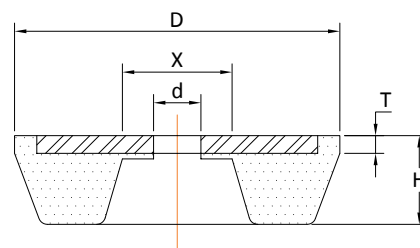

ANTI-VIBRATIONS BØSNINGER



Vibrationsdæmper T-bøsning STÅL / GUMMI



Bøsningen er en prisbillig løsning til isolering af vibrationer, hvilket reducerer støj og absorbere stød for både mobile og statiske applikationer.

Anvendelse:
Motorer, førerhuse, pumper, brændstoftanke, radiatorer, kompressorer og industrielt udstyr etc.

60 Shore A				
Varenr.	A	B	D	DKK
AV11-1	27	17,5	20	36,05
AV11-2	43	25	31	34,25
AV11-3	49	35	34	89,40
AV11-4	63	30	41	131,00

Vibrationsdæmper bøsning STÅL / GUMMI



AV12 er en billig produkt, der normalt anvendes som en fastgørelsesmetode, men også til at isolere højfrekvente vibrationer.

Anvendelse:
Køretøj og motorcykel karrosseridele, letvægts udstyr, elektronik etc.

55 Shore A				
Varenr.	D	K x L	Dim	DKK
AV12-1	7,2	9x9	M3	19,10
AV12-2	9,3	12x11,5	M4	20,35
AV12-3	10,2	15x14,5	M5	23,95
AV12-4	12,7	18x17	M6	26,80
AV12-5	16,5	24x22	M8	33,75

Vibrationsdæmper 2-delt bøsning



STÅL / GUMMI
Et universel og alsidigt produkt. Den 2-delte bøsning er en fremragende anti-vibrations løsning for både mobile og statiske applikationer.

Anvendelse:
Byggemateriel, elproduktion, militære køretøjer, landbrug, industrimaskiner og radiatorer.

Varenr.	Ø	B	Shore A	DKK
AV13-1	33	20,1	45	46,90
AV13-2	33	20,1	60	46,90
AV13-3	47,5	31	45	115,50
AV13-4	47,5	31	60	115,50
AV13-5	64	39,5	45	132,00
AV13-6	64	39,5	60	132,00

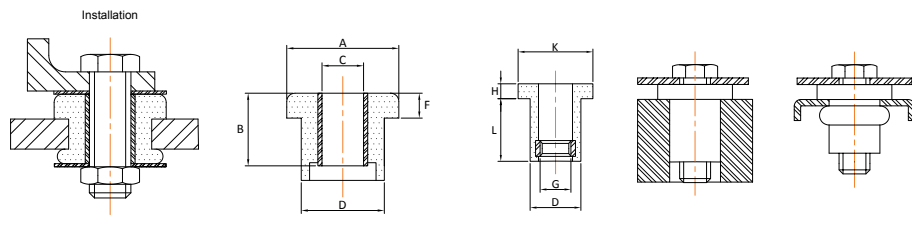

SIKREDE & MARINE SVINGNINGSDÆMPERE



Svingningsdæmperne er tilpasset mobile- og marineanlæg, hvor der ønskes stor dæmpning og god stabilitet. Dæmperen er velegnet til isolering af aksiale og radiale stød. Den er også velegnet til anlæg, som er udsat for store vindbelastninger, hvor det er meget vigtigt at dæmperen er sikret.

Dæmperen kan også anvendes til passiv isolering af udstyr, der står nær eller på maskiner, der vibrerer meget. Det kan være styrings- eller sikringskabe, der både skal vibrationsdæmpes og samtidigt være sikret mod at falde ned. Dæmperens design giver gummi god beskyttelse mod dryppende olie og diesel.

Anvendelse: Marineanlæg, mobile anlæg, kompressorer, pumper, ventilatorer etc.

Vibrationsdæmper sikret

STÅL / GUMMI

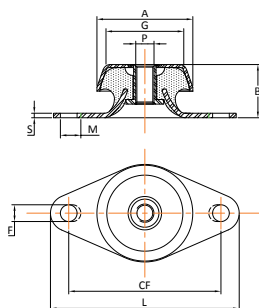

EV14 er udformet med en indbygget overbelastnings-stopper, som styrer bevægelsen af udstyret under transit og giver en fejlsikker enhed, der er egnet til både mobile og statiske applikationer. Let at installere, komponenterne har tydelige og holdbare mærker, som gør at komponenterne kan identificeres, selv efter mange års brug.

Anvendelse:

Generatorsæt, pumper, motorer, ventilatorer, industri- og marinemotorer, kompressorer, byggeri- og anlægsudstyr, køretøjer etc.

Varenr.	L x B	P	Max kg	DKK
AV14-1	110x35	M12	40	263,75
AV14-2	110x35	M12	60	263,75
AV14-3	110x35	M12	100	263,75
AV14-4	110x35	M12	125	263,75
AV14-5	110x35	M12	175	263,75
AV14-6	110x35	M12	225	263,75
AV14-7	120x35	M12	50	290,50
AV14-8	120x35	M12	80	290,50
AV14-9	120x35	M12	120	290,50
AV14-10	125x30	M12	110	192,25
AV14-11	125x30	M12	280	192,25
AV14-12	135x35	M12	70	198,50
AV14-13	135x35	M12	140	198,50
AV14-14	135x35	M12	190	198,50
AV14-15	144x35	M12	200	317,00

AV14-16	144x35	M12	310	317,00
AV14-17	171x38	M16	250	267,25
AV14-18	171x38	M16	350	267,25
AV14-19	171x38	M16	500	267,25
AV14-20	171x42	M16	200	267,25
AV14-21	171x42	M16	375	267,25
AV14-22	171x42	M16	500	267,25
AV14-23	171x42	M16	610	267,25
AV14-24	190x42	M16	400	371,00
AV14-25	190x42	M16	610	371,00
AV14-26	216x48	M16	750	739,75
AV14-27	216x48	M16	1500	739,75
AV14-28	216x53	M16	500	739,75
AV14-29	216x53	M16	800	739,75
AV14-30	216x53	M16	1800	739,75

Vibrationsdæmper marine

STÅL / GUMMI



Specielt designet til brug med marine motorer, men er populære i en bred vifte af andre industrier. Har 3-vejs retningsbestemt kontrol, disse fejlsikre svingningsdæmpere kan rumme fremstød fremstillet af propeller og drivaksler. Metal dækslet beskytter gummi fra forurenede olie og brændstof, og den beskyttende finish modstår korrosion og tilbyder en udvidet livscyklus.

Egnet til mange forskellige typer applikationer: Marine, industri og dieselmotorer, generatorer, pumper og andre motorer.

Varenr.	A x B x dim	Shore A	Max kg	DKK
AV15-1	120 x 38,5 x M12	45	50	247,50
AV15-2	120 x 38,5 x M12	55	75	247,50
AV15-3	120 x 38,5 x M12	65	90	247,50
AV15-4	183 x 50 x M16	45	150	266,50
AV15-5	183 x 50 x M16	55	225	266,50
AV15-6	183 x 50 x M16	65	300	266,50
AV15-7	183 x 50 x M16	75	425	266,50
AV15-8	228 x 74 x M20	45	450	776,75
AV15-9	228 x 74 x M20	55	650	776,75
AV15-10	228 x 74 x M20	65	800	776,75
AV15-11	228 x 74 x M20	75	1000	776,75

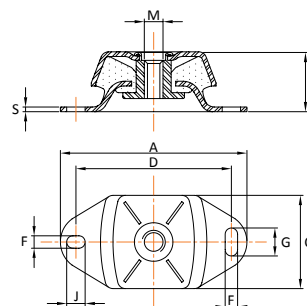

Spindel justerbar

STÅL



Varenr.	Dim	L	DKK
AV16-1	M12	100	56,15
AV16-2	M16 / M12	110	77,00
AV16-3	M16	110	85,75

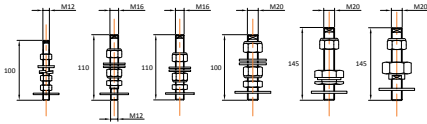

DÆMPERE MED FLANGE



Vibration / støddæmpere med flange tilbyder en høj elasticitet i både radial og aksial retning, det giver et fremragende niveau af vibrationsreduktion og støddæmpning. Lave omkostninger og let at installere.

Anvendelse: Pumper, ventilatorer, kompressorer, vibrationsstømpere og procesudstyr mv.

Vibrationsdæmper flange

STÅL / GUMMI



En simpel og økonomisk vibrationsdæmper, der typisk anvendes i kompression. AV17 er fremstillet med og uden et indskudt metal, der øger lastkapaciteten.

Anvendelse:

Generatorsæt, pumper, ventilatorer, kompressorer og bearbejdningsudstyr m.fl.

60 Shore A

Varenr.	Ø	Dim	Max kg	DKK
AV17-1	75	M12	250	149,00
AV17-2	75	M12	500	169,25
AV17-3	81	M12	400	179,25
AV17-4	81	M12	750	195,25
AV17-5	125	M20	1200	584,25
AV17-6	125	M20	2000	668,00

Vibrationsdæmper flange

STÅL / GUMMI



AV18 giver et høje niveauer af afbøjning under relativ lav belastning, hvilket giver fremragende niveauer af vibrationsreduktion og stødabsorbering både vertikalt og horisontalt. Prisbillig og let at installere, velegnet til en lang række applikationer: Pumper, ventilatorer, kompressorer, procesudstyr m.fl.

60 Shore A

Varenr.	D x B	Dim	Max kg	DKK
AV18-1	60x20	M6	9	45,60
AV18-2	60x21,5	M8	76	84,75
AV18-3	73x25	M10	40	64,40
AV18-4	92x45	M10	69	114,50
AV18-5	110x40	M10	100	157,25
AV18-6	124x45	M10	220	228,75

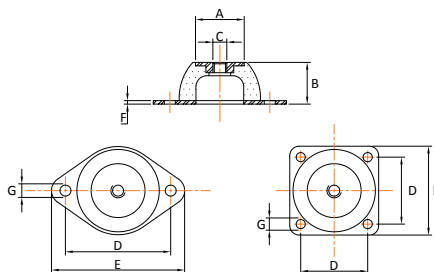
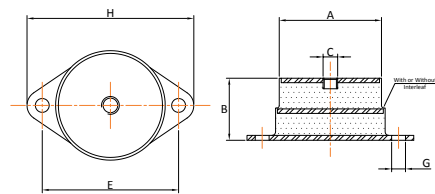

SANDWICH DÆMPERE



Sandwich-dæmperne er nogle af de simpleste dæmpere i vores sortiment, men anvendes de rigtigt yder de god isolation til en fornuftig pris. De er konstrueret til meget høje trykbelastninger og anvendes til dæmpning af støj og vibrationer fra større stationære maskininstallationer såsom blæsere, ventilatorer,

pumper, tragte, lyd kamre, dieselmotorer og lignende. Kan også anvendes til vibrationsborde.

Vibrationsdæmper sandwich

STÅL / GUMMI



AV19 er fremstillet af god kvalitetsgummi, der er støbt i mellem to metal flanger med en sekundær indskudt metalskive i gummiafsnittet. Det indskudte metal øger den maksimale belastning af beslagene, hvilket betyder at de er i stand til at modstå betydeligt højere belastninger.

Anvendelse: Motorophæng, generatoranlæg, store planter, maskiner m.fl.

Varenr.	A x B x C	Shore A	Max kg	DKK
AV19-1	110 x 57 x 43	45	190	303,00
AV19-2	110 x 57 x 43	60	375	303,00
AV19-3	110 x 57 x 43	70	500	303,00
AV19-4	168 x 57 x 43	45	450	332,75
AV19-5	168 x 57 x 43	60	850	332,75
AV19-6	168 x 57 x 43	70	1000	332,75

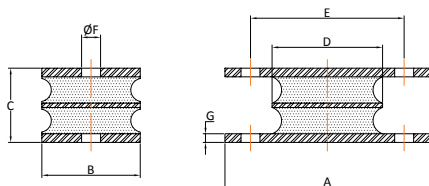

MASKINSKO



Maskinsko anvendes til dæmpning af støj og vibrationer samt i bærende konstruktioner af forskellig art.

Maskinsko bruges f.eks. ved drejebænke, fræsemaskiner, bearbejdningscentre, vand- / laser- / plasmaskæring eller til bearbejdning af træ, i emballage industrien, solenergi og vedvarende energi, til fødevareforarbejdning m.fl.

Maskinsko justerbar

STÅL / GUMMI



60 Shore A

Varenr.	D x H	Dim	DKK
AV20-1	80 x 25	M10	200,25
AV20-2	90 x 35	M12	443,00
AV20-3	120 x 35	M12	546,75
AV20-4	150 x 40	M16	1042,75
AV20-5	200 x 45	M20	1999,75

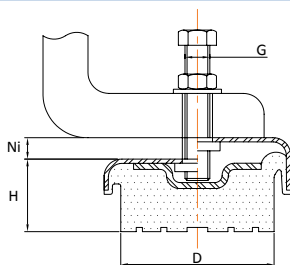

Maskinsko justerbar

STÅL / GUMMI



60 Shore A

Varenr.	D x H	Dim	L	DKK
AV26-1	80 x 38-48	M12	100	507,25
AV26-2	120 x 43-55	M16	120	900,00
AV26-3	160 x 48-53	M20	170	1528,75

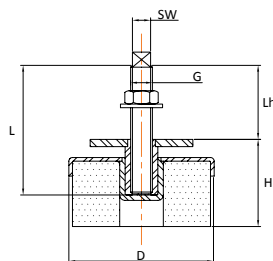

Maskinsko nivellering

STÅL / GUMMI



Nivelleringsfødder er fuldt justerbare og er meget stærke, de understøtter op til 3000 kg. AV21 anvendes typisk steder, hvor vibrationsisolering og kemisk resistens er af stor betydning. Fødderne er fremstillet særdeles godt og er lavet til at holde. De beskytter det udstyr, de er installeret på samt forlænge udstyrets levetid.

60 Shore A

Varenr.	D x A	Dim	Max kg	DKK
AV21-1	50 x 29	M10 x 100	400	215,75
AV21-2	80 x 35	M12 x 100	1000	402,50
AV21-3	100 x 38	M16 x 100	1500	631,50
AV21-4	120 x 42	M20 x 200	3000	641,50

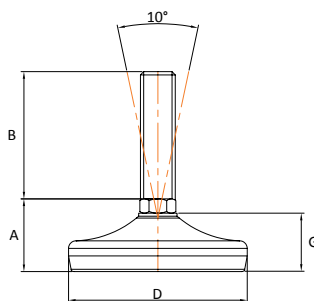

Maskinsko nivellering

STÅL / GUMMI



Maskinfødderne er fuldt justerbare og anvendes i en bred vifte af frekvenser samt forskellige miljøforhold. Vores vibrationsdæmpende nivellerings fødder er perfekte til isolering af et system mod uønskede vibrationer og resonans, idet de er designet til at sænke den naturlige frekvens af systemet.

60 Shore A

Varenr.	A x B	dim x D	Max kg	DKK
AV22-1	40 x 23	M8 x 48 80	54,85	
AV22-2	60 x 28	M10 x 81 120	123,75	
AV22-3	70 x 32	M12 x 89 160	209,75	
AV22-4	85 x 32	M12 x 89 350	254,25	

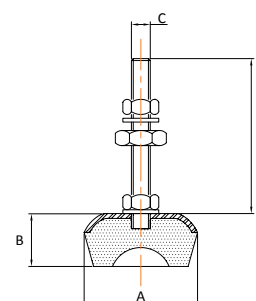

HVAC & LOFT- OPHÆNGTE DÆMPERE



Vibrationsdæmper kegle

STÅL / GUMMI



En enkel og effektiv monteringsopløsning, der hovedsagelig anvendes til understøtning af varme-, ventilations- og klimaanlæg. Gummiblandingen indkapsler metallet fuldt i AV23 ophænget, som giver fremragende miljømæssig modstand.

Anvendes typisk til opvarmning, ventilation og klimaanlæg, pumper, ventilatorer og kompressorer.

Varenr.	A x F	Code	Shore A	DKK
AV23-1	80 x 32	yellow	45	66,45
AV23-2	80 x 32	blue	55	66,45
AV23-3	80 x 32	red	65	66,45
AV23-4	95 x 45	yellow	55	122,50
AV23-5	95 x 45	blue	45	122,50
AV23-6	95 x 45	red	65	122,50
AV23-7	150 x 70	yellow	55	199,25
AV23-8	150 x 70	blue	45	199,25

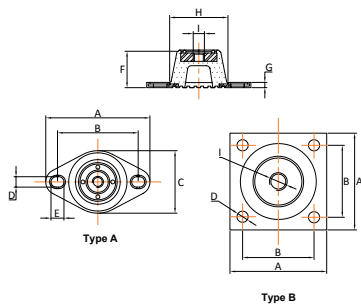

Vibrationsdæmper loftophæng

STÅL / GUMMI

Anvendelsesområder:

HVAC-systemer, kanaler og rørledninger, udstødningssystemer mv.



Varenr.	TVAR	Min kg	Max kg	DKK
AV24-1	40	8	25	64,40
AV24-2	60	18	50	64,40
AV24-3	75	25	75	64,40

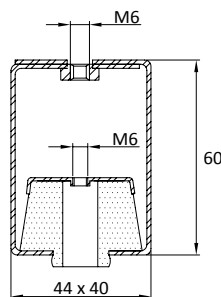

LAD OS HØRE FRA DIG

ROYKON AS har bred erfaring i levering af specialkomponenter i rustfri og messing. Vi kan tilbyde serier fra 100 til mange 100.000 enheder.

De fabrikker, vi får produceret på, besøges i gennemsnit en gang om året. Vi har igennem årene haft et langt udskillelsesløb, hvor de fabrikker, vi bruger i dag, er fabrikker med meget høje standarder og kvalitetskrav.

Vi tilbyder at give en hurtig pris på dine specialkomponenter og på pro-

duktionssiden betyder det, at vi i udviklingsfasen har lynhurtig tilbagemelding og at kvaliteten af produkterne er, som vores kunder har specificeret.

Vores leverandører er miljøbeviste, benytter ikke børnearbejde og har ordnede forhold for alle medarbejdere.

Således føler vi os nu rustet til at levere kvalitetsfittings til virksomheder, for hvem kvalitet er en selvfølge og hvor miljø og social bevidsthed har betydning.

**RING FOR ET
UFORPLIGTENDE
BESØG PÅ TELEFON:**

75 945 955



STØRRELSESGUIDE

SLANGESTØRRELSER		SVEJSEFITTINGS		DN	Tommer	MM
"	mm indv.	"	mm	DN	"	mm
1/8"	4	1/8"	10,2	6	1/8"	10,2
3/16"	5	1/4"	13,5	8	1/4"	13,5
1/4"	6	3/8"	17,2	10	3/8"	17,2
5/16"	8	1/2"	21,3	15	1/2"	21,3
3/8"	10	3/4"	26,9	20	3/4"	26,9
1/2"	12,5	1"	33,7	25	1"	33,7
5/8"	16	1 1/4"	42,4	32	1 1/4"	42,4
3/4"	19	1 1/2"	48,3	40	1 1/2"	48,3
1"	25	2"	60,3	50	2"	60,3
1 1/4"	32	2 1/2"	76,1	65	2 1/2"	76,1
1 1/2"	38	3"	88,9	80	3"	88,9
2"	52	4"	114,3	100	4"	114,3
2 1/2"	62	5"	139,7	125	5"	139,7
3"	77	6"	168,3	150	6"	168,3
4"	102	8"	219,1	200	8"	219,1
5"	127	10"	273,1	250	10"	273,1
6"	153	12"	323,9	300	12"	323,9

TRYKTABEL FOR GEVINDRØR ANGIVET I BAR

Vores gevindrør er i **AISI 316 rustfri syrefast stål**. Udregningen er baseret på DIN2413 WR 1.4401. Her har du en PDF tabel, hvor du kan se, hvad de kan tåle af tryk, ved forskellige temperaturer:

Rørdim.	mm	- - gods	20°C	100°C	150°C	200°C	250°C	300°C	350°C	400°C
1/4"	13,5	2,24	463	451	426	417	398	374	356	342
3/8"	17,2	2,30	373	348	331	325	306	288	275	265
1/2"	21,3	2,65	347	319	307	299	282	264	253	243
3/4"	26,9	2,65	219	244	244	229	215	202	194	186
1"	33,7	3,25	269	239	239	224	210	197	189	182
1 1/4"	42,4	3,25	214	188	186	174	163	153	146	140
1 1/2"	48,3	3,25	188	165	162	150	141	133	128	122
2"	60,3	3,65	169	149	144	134	127	118	114	109
2 1/2"	76,1	3,60	132	116	100	104	98	92	87	84
3"	88,9	4,05	127	112	107	99	93	88	84	81

GEVIND BESKRIVELSER

DER FINDES 2 TYPER RØRGEVIND

- PARALLEL OG KONISK.

1. Parallel rørgevind som sædvanligvis anvendes, når tætning **ikke er** på gevindet.
2. Konisk rørgevind som sædvanligvis anvendes, når tætning **er** på gevindet.

DER FINDES 2 SYSTEMER FOR RØRGEVIND - BRITISK (WHITWORTH 55°) OG AMERIKANSK (60°)

1. Whitworth, ud over at have en flankevinkel på 55°, har 4 standard stigninger - 28, 19, 14 og 11 TPI
2. Amerikansk, ud over at have en flankevinkel på 60°, har 5 standard stigninger - 27, 18, 14, 11½ og 8 TPI

Den første vigtige ting at bemærke er, at diameteren (d/D) på et rørgevind er ikke den faktiske diameter.

Den diameter som angives, er baseret på røret's indvendige diameter, da det er røret's indvendige diameter (hul) der er væsentlig. For eksempel er den faktiske diameter på et 1" Whitworth rørgevind ikke $1 \times 25,4 = 25,4\text{mm}$ - men **33,25mm** og en 1" amerikansk rørgevind ikke $1 \times 25,4 = 25,4\text{mm}$ - men **33,40mm**.

Derfor bør man altid checke den relevante norm for de korrekte mål.

Da Whitworth rørgevind er mere enkel (efter min mening), end den amerikanske (og mere anvendt i Europa), tages dette gevindtype først.

WHITWORTH (PARALLEL) RØRGEVIND REF. ISO 228-1

(BSP = British Standard Pipe)

Dette gevind har følgende anerkendte betegnelser (forkortelser) : **G, BSP**

Et indvendigt gevind har kun én toleranceklasse, men det udvendige gevind har to - **A** og **B**. Det indvendige gevinds delediameter tolerance er den samme som **A** i det udvendige gevind, og tolerance **B** er nøjagtig dobbelt så stor som **A**.

I standarden ISO 228-1 angives de korrekte betegnelser ved, for eksempel en 1½ rørgevind som følger :

Indvendigt gevind **ISO 228-G 1½** og udvendigt gevind **ISO 228-G 1½ A** eller **ISO 228-G 1½ B** afhængig af den valgte tolerance.

Delediameter tolerancen på et udvendigt gevind er altid fra nominal og minus og for et indvendigt gevind fra nominal og plus. I teori kan de begge (udvendigt og indvendigt) have nøjagtigt den samme delediameter mål - nemlig nominal.

WHITWORTH (KONISK) RØRGEVIND REF. ISO 7-1

(BSPT = British Standard Pipe Taper)

Dette gevind har følgende anerkendte betegnelser (forkortelser) : **R, Rc, Rp, BSPT**

Et indvendigt gevind kan enten være parallel eller konisk. For eksempel ved en 1½" rørgevind.

- Et indvendigt og parallel rørgevind har betegnelsen **ISO 7 - Rp 1½**
- Et indvendigt og konisk rørgevind har betegnelsen **ISO 7 - Rc 1½**
- Et udvendigt gevind er altid konisk og har betegnelsen **ISO 7 - R 1½**

Delediameter tolerancen på et konisk gevind svarer størrelsesmæssigt cirka til **B** tolerancen på et parallel rørgevind. For mere information om denne anbefales at der læses normen ISO 7-1 eller side 3.06 af FMS gevindhåndbog CD.

AMERIKANSK (NP) RØRGEVIND

Der er betydeligt flere typer Amerikansk rørgevindtyper, end der er Whitworth. Der kan derfor kun gives lidt generel information om disse. Det anbefales, at den relevante standard anvendes ved specificering, fremstilling og/eller kontrol.

Anvendte forkortelser i angivelsen af amerikansk rørgevindtyper:

ENGELSK	DANSK
N National Standard	National Standard
P Pipe	Rør
T Taper	Konisk
C Coupling	Kobling
S Straight	Parallel
M Mechanical	Mekanisk
L Locknut	Låsemøtrik
H Hose Coupling	Slangekobling
R Railing Fitting	Skinne Fitting
F Fine	Fin

Nogle gevindbetegnelser (forkortelser) for Amerikansk parallel rørgevind.

NPSI, NPSM, NPSL, NPSH, NPSF, NPSI

Nogle gevindbetegnelser (forkortelser) for amerikansk konisk rørgevind.

NPT, NPTR, NPTF

NOMINELLE DIAMETRE KONTRA TOMMES GEVIND/STØRRELSER

Ø	Dim
16	3/8"
20	1/2"
25	3/4"
32	1"
40	1 1/4"
50	1 1/2"
63	2"
75	2 1/2"
90	3"
110	4"

MATERIALEBETEGNELSER

FORKORTEELSE	MATERIALE	BETEGNELSE
Acryl	plast	Polyacryl (plexiglas)
ALU	metal	Aluminium
EPDM	gummi	Ethylene Propylene Diene Monomer
HD teflon	plast	High Density teflon
Hypalon®	gummi	Dupont chlorosulfonated polyethylene
LD teflon	plast	Low Density teflon
MD teflon	plast	Medium Density teflon
MS	metal	Messing
NBR	gummi	Nitrile Butadiene Rubber
Nylon	kunstoffibre	Polyamider
PA	plast	PolyAmid (nylon)
PBT	plast	PolyButylene Terephthalate
PC	plast	PolyCarbonat
PE	plast	PolyEthylen
PEM	plast	PolyEthylen Monomer
PEX	plast	Cross-linked polyethylene
POM	plast	Polyacetal (acetal)
PP	plast	PolyPropylen
PTFE	teflon	PolyTetraFluoroEthylen
PU	plast	PolyUrethan
PVC	plast	PolyVinylClorid
PVDF	plast	PolyVinylidene Fluoride (teflon)
RS304	metal	Rustfri Stål AISI 304
RS316	metal	Rustfri Stål AISI 316
SAN	plast	Styrene AcryloNitrile
SBR	plast	Styrene Butadiene Rubber
VITON®	gummi	Dupont fluoroelastomer

PIKTOGRAMFORKLARING



Tryk



Temperatur



Standarder



Certifikater



Godkendt til drikkevand (VA)

RESISTENSLISTE

Beskrivelse (% , °C)	Messing	SUS 304	Acetal	PBT	PP	NBR	EPDM
Kaustisk soda (10%,20°C)	2	2	4	2	3	3	4
Benzin	3	3	4	4	2	4	1
Myresyre (25%,20°C)	1	2	1	3	4	3	4
Luft	4	4	4	4	4	4	4
Miniralsk olie	3	3	4	4	3	4	1
Fedt	3	4	4	4	2	4	1
Natrium silikat	3	0	4	3	4	4	4
Glycerin	3	4	4	4	4	4	4
Ozon	3	3	2	4	2	3	4
Animalsk olie	3	0	4	4	3	4	3
Petroleum	4	4	4	4	4	4	1
Methan	3	0	4	4	4	4	1
Methanol	4	2	3	3	3	4	4
Vand (24°C)	3	3	4	3	4	4	4
Vand (100°C)	1	3	2	1	2	0	0
Salt vand	2	3	4	3	4	0	0
Bunkerolie	2	0	0	0	3	4	0
Benzen	1	2	3	3	2	1	1
Butan	4	4	4	4	4	4	1
Fluor	1	1	1	0	1	0	2
Borsyre	3	3	3	3	4	4	4
Tetrachlormethan	2	2	3	3	2	2	1
Oxygen	4	4	3	3	3	3	4
Petroleum	0	0	3	3	1	4	1
Soda (natriumcarbonat)	3	2	4	3	4	4	4
Calciumhydroxid	2	2	4	1	3	4	4
Hydrogen	2	4	4	4	4	4	4
Kviksølv	1	0	0	0	4	4	4
Damp (150°C)	3	0	2	2	1	1	4
Natriumcyanid	1	0				4	4
Vegetabilsk olie	0	0	3	3	3	4	4
Silicone fedt	0	0	4	4	2	4	4
Silicone olie	0	0	4	4	2	4	4
Acetone	4	2	3	3	2	1	4
Svovlsyrling	0	0	2	3	3	3	3
Ammoniak	2	4	3	2	3	4	4
Flydende petroleum	4	4	4	4	3	4	1
Ethyl alkohol (Ethanol)	4	3	4	4	3	4	4

Meget acceptabelt	4
Acceptabelt	3
Let acceptabelt	2
Uacceptabelt	1
Ingen data	0

RESISTENSLISTE

Beskrivelse (% , °C)	Messing	SUS 304	Acetal	PBT	PP	NBR	EPDM
Lud opløsning	0	0	4	3	3	3	4
Saltsyre (10%,20°C)	1	1	1	3	4	0	0
Saltsyre (20%,20°C)	1	1	1	2	3	0	0
Saltsyre (20%,80°C)	1	1	1	1	1	1	2
Saltsyre (38%,20°C)	1	1	1	2	3	3	4
Ammoniumchlorid	1	2	4	3	4	4	4
Calciumchlorid	3	2	4	3	4	4	4
Naphtha	2	3	4	3	2	2	1
Oliven olie	2	4	3	4	3	4	3
Svovl	1	3	4	0	4	1	4
Natriumfosfat	1	2	4	3	4	4	4
Ammoniumfosfat	2	2	4	3	4	4	4
Ammonium nitrat	1	3	3	3	4	4	4
Nitrogen	3	4	4	3	4	4	4
Natur gas	4	4	4	4	3	4	1
Eddikesyre (10%,20°C)	1	3	2	3	4	3	4
Eddikesyre (50%,20°C)	1	3	1	3	3	0	0
Eddikesyre (50%,70°C)	1	3	1	2	1	0	0
Eddikesyre (100%,20°C)	1	2	1	3	1	0	0
Ketoner	3	3	3	3	4	0	3
Kresol	3	2	2	3	3	2	1
Chromsyre (2%,70°C)	1	1	1	1	2	0	0
Chromsyre (10%,70°C)	1	1	1	1	1	0	0
Chromsyre (25%,70°C)	1	1	1	1	1	0	0
Chromsyre (2%,50°C)	1	1	1	2	2	1	3
Sojaolie	2	3	4	4	3	4	2
Toluen	4	4	3	2	2	1	1
Glucose	4	4	4	4	4	4	4
Propan	4	4	4	4	4	4	1
Ricinusolie	3	3	3	3	4	4	3
Svovlsyre (10%,20°C)	1	1	1	3	3	1	3
Svovlsyre (10%,70°C)	1	1	1	1	2	0	0
Svovlsyre (30%,20°C)	1	1	1	2	3	0	0
Svovlsyre (30%,70°C)	1	1	1	1	2	0	0
Svovlsyre (98%,20°C)	1	1	1	1	1	0	0
Aluminum sulfat	1	3	4	3	4	4	4
Kalium sulfat	3	2	4	3	4	4	4
Hydrogensulfid	2	2	3	3	4	1	4

Meget acceptabelt	4
Acceptabelt	3
Let acceptabelt	2
Uacceptabelt	1
Ingen data	0

ALFABETISK INDHOLDSFORTEGNELSE

000001-G	561	000291-G	566	045095	164	449117804	742	744950006	593	A21	199
000001-S	554	000291-S	558	045095-20	166	449118804	742	744950022	107	A21C	199
000002-G	561	000300-G	566	045096	164	743171509	579	744950022	593	A2-1PP	515
000002-S	554	000300-S	559	045096-20	166	743523104s	738	774545050	635	A22	199
000003-G	561	000310-G	566	045120	163	743523104	738	8815A	546	A2-2PP	515
000010-G	561	000310-S	559	045121	164	744700017	503	8815RS	546	A23	198
000010-S	554	000340-G	567	045121-20	166	744704001	500	A1	506	A24	199
000020-G	561	000340-S	559	045123	164	744705002	503	A10	507	A25	199
000020-S	554	000341-G	567	045123-20	166	744707002	503	A101PP	515	A26	199
000040-G	562	000341-S	559	045130	164	744711000	503	A10-1PP	516	A27	142
000040-S	554	000471-G	567	045130-20	166	744712020	501	A102PP	516	A27	360
000041-G	562	000529-G	567	045160	163	744808004	106	A10-2PP	516	A28-1	142
000041-S	554	000529-S	559	045160-20	166	744808004	592	A105PP	517	A28-1	360
000060-G	563	000685	700	045163	164	744808006	106	A106PP	517	A28-2	142
000085-G	563	000685	416	045165	163	744808006	592	A109	517	A28-2	360
000085-S	555	012030103	559	045165-20	166	744808036	107	A109-2	517	A28-3	142
000090-G	562	012030104	559	045170	163	744808036	593	A10C	507	A28-3	360
000090-G2	562	012030403	568	045170-20	166	744809004	106	A10T	510	A29	747
000090-S	555	012030404	568	045180	164	744809004	592	A11	604	A29-20	769
000090-S2	555	012040102	559	045-1882	576	744809036	106	A112-1	519	A2C	507
000092-G	562	012040106	560	045-1975	576	744809036	592	A112-16	519	A2C-2	516
000092-G2	562	012040108	560	045-1985	576	744810004	106	A1-1PP	514	A2C45	516
000092-S	555	012040402	568	047082	164	744810004	592	A12	507	A2CS	516
000092-S2	555	012040406	568	047082	166	744810006	107	A120	194	A2T	510
000096-G	563	012040408	568	048090	578	744810006	593	A121	194	A3	508
000096-S	555	012060110	560	048092	578	744811006	106	A122	194	A30-2	747
000098-G	563	012060111	560	048094	578	744811006	592	A123	194	A30-3	85
000098-S	555	012060401	568	048130	578	744812003	106	A126	194	A30-3	747
000120-G	563	012060410	569	048240	579	744812003	592	A127	195	A30-4	747
000120-S	555	012060411	569	048241	579	744812004	106	A128	195	A30-5	85
000121-G	563	012080112	560	048245	578	744812004	592	A128G	195	A30-5	747
000121-S	555	012080113	560	048270	579	744812024	107	A129	197	A30-50	747
000130-G	563	012080114	560	048280	578	744812024	593	A129	517	A30-60	747
000130-G2	564	012080412	569	048291	579	744812034	107	A1-2PP	514	A3-1PP	518
000130-S	556	012080413	569	070612	149	744812034	593	A13	517	A32-1	749
000130-S2	556	012080414	569	070612	464	744812036	107	A130	195	A32-2	749
000131-G	563	012100116	560	072-1475	149	744812036	593	A131	195	A328	773
000131-S	556	012100416	569	072-3460	148	744816004	106	A132	196	A3-2PP	518
000165-G	563	013270-G	566	072-3461	148	744816004	592	A133	195	A330PP	769
000165-S	556	013270-S	558	072-3462	148	744816006	106	A133-2	196	A34	199
000180-G	564	044020	161	072-3463	148	744816006	592	A134	196	A35	201
000180-S	556	044021	161	072-3464	148	744816022	106	A134-2	196	A36	201
000221-G	564	044023	161	072-3465	148	744816022	592	A135	196	A36L	201
000221-S	556	044030	161	072-3466	149	744816034	107	A137	196	A37	201
000223-G	564	044030R	161	072-3467	149	744816034	593	A139	197	A38	201
000223-S	557	044037	162	072-3469	149	744816036	107	A139	517	A39	201
000240-G	565	044040	162	072-3471	149	744816036	593	A139	521	A390	748
000240-S	557	044054	162	087251015	165	744818004	106	A14	198	A4	508
000241-G	565	044060	160	087251022	166	744818004	592	A140	522	A40	201
000241-S	558	044065	160	418117	736	744818036	107	A141	195	A400	515
000245-G	565	044070	160	418118	736	744818036	593	A15	198	A41	202
000245-S	557	044070R	160	418119	736	744818056	107	A155	539	A4-1PP	518
000246-G	566	044080	162	418120	736	744818056	593	A16	198	A42	202
000246-S	558	044093	162	271302508	627	744841324	107	A17	198	A4-2PP	518
000270-G	566	044094	162	405000003	575	744841324	584	A18	198	A43	202
000270-S	558	044095	162	405000103	575	744850050	107	A19	199	A44	202
000280-G	565	044096	162	405001003	575	744850050	593	A1F	506	A45	202
000280-S	557	044163	161	405001106	575	744950004	107	A1T	510	A46	202
000290-G	566	045036	164	410082004	741	744950004	593	A2	507	A47	202
000290-S	558	045037	164	430377004	768	744950006	107	A20	199	A48	203

A48	723	AC35	204	AD99	84	AL4	215	AR16	226	AV5	794
A48-2	203	AC40	204	AD99	210	AL5	217	AR18	226	AV6	794
A48-2	723	AC43	204	AF8063	222	AL50	213	AR2	224	AV7	794
A49	201	AD105C	83	AF8063	417	AL50	221	AR22	226	AV8	795
A4T	510	AD105C	209	AFB8063	223	AL50	231	AR28	226	AV9	796
A5	508	AD105K	83	AFB8063	417	AL51	213	AR29	226	B0	391
A50	508	AD105K	209	AFL2633	223	AL51	221	AR30	227	B1	390
A50PP	519	AD108	83	AFL2633	418	AL51	231	AR46	227	B10	393
A51-1PP	197	AD108	209	AFNV2642	416	AL52	214	AR5	224	B105	65
A51-2PP	197	AD109	83	AFNV2642C	416	AL52	221	AR6	225	B105	333
A51-6PP	197	AD109	209	AFR2633	223	AL52	231	AR69	769	B105	457
A51-7PP	197	AD110	83	AFR2633	418	AL5U	217	AR70	753	B10L	403
A51-8PA	197	AD110	209	AFV33	752	AL5Y	217	AR70	770	B11	394
A51PP	519	AD111	83	AG1	104	AL6	217	AR71	753	B111	141
A52	202	AD111	209	AG2	104	AL60	222	AR72	753	B111	359
A53PP	519	AD112	83	AG3	104	AL61	222	AR9	225	B112	141
A5PP	518	AD112	209	AG4	104	AL6-1	218	AR98	227	B112	359
A5T	510	AD113	84	AH1	754	AL6-2	218	AR99	225	B12	394
A6	507	AD113	210	AH16	227	AL6-3	218	ARL1	228	B1-2	390
A60	150	AD113	769	AH16	755	AL69	769	ARL1F	228	B12-2	394
A61	151	AD115	84	AH17	237	AL6-O	218	ARL2	229	B12L	403
A6-1PP	517	AD115	210	AH17	755	AL7	216	ARL22	230	B12NPT	408
A62	151	AD116	84	AH18	221	AL70	753	ARL22F	230	B12S	394
A6-2PP	518	AD116	210	AH18	755	AL70	770	ARL29	231	B14	395
A63	151	AD120	84	AH19	771	AL71	753	ARL29F	231	B14	497
A64	152	AD120	210	AH2	754	AL72	753	ARL2F	229	B14G	396
A65	153	AD120	748	AH20	771	ALV33	751	ARL30	231	B14G	498
A66	152	AD121	84	AH21	771	ALV33-1	751	ARL31	230	B14i	395
A67	153	AD121	210	AH22	772	AM60	158	ARL5	229	B14i	497
A68	153	AD122	84	AH23	772	AM61	158	ARL6	229	B14L	403
A69	153	AD122	210	AH24	755	AM62	158	ARL8	229	B14NPT	408
A6T	510	AD122	769	AH25	755	AM63	158	ARL98	228	B14S	396
A7	508	AD123	84	AH28	772	AM64	158	ARL98-1	227	B14S	498
A70	154	AD123	210	AH29	752	AM65	158	ARL99	227	B14U	400
A71	152	AD125	84	AH3	754	AM66	158	ARV33	751	B14V	395
A72	155	AD125	210	AH4	754	AM67	159	ARV33-1	751	B14V	497
A7-2	508	AD126	84	AH5	755	AM68	159	ARV33-2	751	B15	395
A73	156	AD126	210	AH6	755	AM69	159	AS10	509	B15L	403
A74	152	AD80	81	AH7	755	AM70	159	AS106	509	B17	395
A75	151	AD80	207	AHX	752	AM71	158	AS2	509	B17L	403
A76	153	AD81	81	AJ1	150	AM76	159	AS9	509	B18	394
A78	154	AD81	207	AJ1	464	AN10M	513	ATW3	112	B18L	403
A79	151	AD82	81	AJ5	464	AN14B	512	ATW4	112	B19	400
A7PP	519	AD82	207	AL1	215	AN14C	513	AV1	792	B19L	404
A7T	511	AD83	81	AL14	217	AN14D	512	AV10	796	B1L	402
A8	508	AD83	207	AL16	218	AN14L	512	AV11	797	B1NPT	408
A80	152	AD84	81	AL17	218	AN46	512	AV12	797	B2	390
A81	152	AD84	207	AL18	219	AN46M	513	AV13	797	B20	400
A8-1PP	519	AD85	82	AL19	220	AN47	512	AV14	798	B20L	404
A82	154	AD85	208	AL2	216	AP1	212	AV15	798	B20S	400
A8-2PP	519	AD86	82	AL20	221	AP1	464	AV16	799	B21	405
A83	154	AD86	208	AL22	219	AP1-1	212	AV17	800	B22	406
A84	154	AD88	82	AL2-2	216	AP1-1	463	AV18	800	B2-2	391
A85	154	AD88	208	AL28	220	AP4	212	AV19	801	B22NPT	409
A86	154	AD90	82	AL3	216	AP4	464	AV2	793	B23	405
A8T	511	AD90	208	AL300L	752	AP6	212	AV20	802	B24NB	405
A9	508	AD95	83	AL300T	752	AP6	463	AV21	802	B25	407
A9-1PP	518	AD95	209	AL33	751	APT1	212	AV22	802	B25L	404
A9-2PP	518	AD96	82	AL33VIT	751	APT1	464	AV23	803	B26	406
A9T	511	AD96	208	AL340	229	AR1	224	AV24	803	B26L	404
AB14	520	AD97	82	AL340	567	AR10	225	AV25	796	B27	405
AB46	520	AD97	208	AL341	229	AR12	225	AV26	802	B28	393
AB60	205	AD98	82	AL341	567	AR14	225	AV3	793	B28L	403
AB61	205	AD98	208	AL38	215	AR15	226	AV4	793	B28NPT	409

B29	393	B36	462	B62M	95	B89C	63	BFP	397	BP30B	615
B2L	402	B36-2	462	B62N	99	B89C	331	BG1	102	BP30C	71
B2NPT	408	B370S304	761	B62PP	97	B89C	456	BG2	102	BP30C	615
B3	391	B370S316	761	B63	89	B89K	63	BG3	102	BP30D	71
B3100	732	B38	392	B63A	93	B89K	331	BG4	102	BP30D	615
B320	728	B39H	732	B63-LOCK	91	B89K	456	BG5	102	BP30E	71
B32A-REDU	727	B3L	402	B63M	95	B8B7	398	BG5	103	BP30E	615
B32B	728	B4	391	B63N	99	B8L	403	BG5	104	BP32	72
B32C	728	B40S	329	B63PP	97	B8NPT	410	BG6	102	BP32	616
B32L	404	B40S	401	B64	89	B8S	399	BH33	728	BP32A	72
B32-REDU	727	B41S	329	B64	91	B9	392	BH33-1	728	BP32A	616
B33	671	B41S	401	B64A	93	B90	764	BH8	397	BP32B	72
B33	727	B42S	287	B64M	95	B90-2	764	Bi68	480	BP32B	616
B33-22	672	B42S	329	B64N	99	B92	765	Bi69	472	BP32C	72
B33-22	729	B43S	329	B64PP	97	B94	63	Bi69-2	472	BP32C	616
B33-22A	729	B43S	401	B65	88	B94	331	Bi72	477	BP32D	72
B33-22-ISO	672	B44S	329	B65	90	B94	456	BJ1	419	BP32D	616
B33-22-ISO	728	B44S	401	B65A	92	B97	63	BJ2	419	BP33	74
B33-22L	404	B45S	329	B65M	94	B97	331	BJ3	419	BP33	618
B33-42	729	B45S	401	B65N	98	B97	456	BK35	422	BP33A	74
B33-42-ISO	672	B46	395	B65PP	96	B98	63	BK35	443	BP33A	618
B33-42-ISO	729	B46	498	B66	89	B98	331	BK35	462	BP33B	74
B33-52	729	B460D	319	B66A	93	B98	456	BK36	462	BP33B	618
B33-52-ISO	672	B460E	319	B66-LOCK	91	B9L	403	BL3	732	BP33H	74
B33-52-ISO	729	B47	409	B66M	95	B9NPT	408	BL5	401	BP33H	618
B33ACDA	784	B47	438	B66N	99	BA1	762	BP0	72	BP4	76
B33ACSR	784	B4L	402	B66PP	97	BC21	405	BP0	616	BP4	610
B33AIR-4C	789	B4NPT	408	B67	89	BC22	406	BP1	70	BP40	75
B33AIR-4V	789	B5	391	B67	91	BC22-NPT	409	BP1	614	BP40	619
B33AIR-D4C	789	B5L	402	B67A	93	BC25	406	BP12	77	BP41	75
B33AIR-D4V	789	B5U	391	B67M	95	BC25-304	406	BP12	473	BP41	619
B33AIR-DA	788	B5UL	402	B67N	99	BE31	499	BP12	611	BP42	75
B33AIR-L	789	B5V	392	B67PP	97	BE32	499	BP12L	77	BP42	619
B33AIR-M	789	B5V-1	392	B6B7	398	BE33	499	BP12L	473	BP5	76
B33AIR-NC	788	B5V-2	392	B6L	403	BE35	499	BP12L	611	BP5	610
B33AIR-NO	788	B5V-3	392	B6S	399	BE36	499	BP14	79	BP61	78
B33AIR-SEAT	789	B5Y	392	B7	398	BE51	66	BP14	473	BP61	612
B33AIRV-DA	790	B6	397	B70-1	761	BE51	459	BP1A	70	BP62	78
B33AIRV-NC	790	B60	88	B70-2	761	BE54	66	BP1A	614	BP62	612
B33AIRV-NO	790	B60	90	B70-3	761	BE54	459	BP1B	70	BP63	79
B33B	727	B6050	308	B70-4	761	BE55	66	BP1B	614	BP63	613
B33EL	786	B60A	92	B71	762	BE55	459	BP1C	70	BP64	79
B33EL-1	786	B60M	94	B72	762	BE56	66	BP1C	614	BP64	613
B33EL-2	785	B60N	98	B73	762	BE56	459	BP1D	70	BP70	74
B33EL-3	786	B60P-1	100	B74	762	BE58	66	BP1D	614	BP70	618
B33EL-4	786	B60P-10	101	B75	399	BE58	459	BP1E	70	BP73	75
B33EL-5	786	B60P-2	100	B8	397	BE59	66	BP1E	614	BP73	619
B33EL-6	786	B60P-3	100	B80	62	BE59	459	BP2	73	BP74	75
B33EL-7	785	B60P-4	100	B80	330	BE60	66	BP2	617	BP74	619
B33EL-A	776	B60P-5	100	B80	455	BE60	459	BP2A	73	BP8	76
B33-ISO	728	B60P-6	100	B81	62	BE71	66	BP2A	617	BP8	610
B33L	404	B60P-7	101	B81	330	BE71	459	BP2B	73	BP80	75
B33-LOCK	671	B60P-8	101	B81	455	BF14U	400	BP2B	617	BP80	619
B33-LOCK	727	B60P-9	101	B82	63	BF19	401	BP2C	73	BP81	75
B33N	727	B60PP	96	B82	330	BF20	401	BP2C	617	BP81	619
B33SH	730	B61	89	B82	455	BF20S	400	BP2E	73	BP82	75
B34	732	B61A	93	B84	63	BF6	397	BP2E	617	BP82	619
B34-24	731	B61-LOCK	91	B84	330	BF6B7	398	BP3	76	BP9	77
B34F	732	B61M	95	B84	455	BF6S	399	BP3	610	BP9	611
B34G	731	B61N	99	B86	63	BF7	398	BP30	71	BP9-2	77
B34GV	731	B61PP	97	B86	331	BF7S	399	BP30	615	BP9-2	611
B34SH	730	B62	89	B86	455	BF8	397	BP30A	71	BR10	486
B36	422	B62A	93	B8850	308	BF8B7	398	BP30A	615	BR101	476
B36	443	B62-LOCK	91	B8952	308	BF8S	399	BP30B	71	BR102	476

BR103	477	BR373	479	C21	448	CP14	428	CP214	458	DA25	621
BR104	477	BR374	479	C22	448	CP140	438	CP23	431	DA26	621
BR11	487	BR5	486	C24	447	CP142	439	CP25	431	DA3	620
BR114	473	BR570	480	C28	450	CP14-2	428	CP26	432	DA30	582
BR115	472	BR6	486	C3	444	CP144	439	CP27	432	DA31	582
BR117	472	BR603	472	C31	446	CP145	439	CP3	428	DA32	582
BR12	487	BR650	473	C35	449	CP146	440	CP30	432	DA33	582
BR123	476	BR650	570	C36	449	CP147	440	CP35	430	DA34	582
BR127	477	BR651	473	C38	446	CP148	440	CP39	430	DA39	582
BR13	487	BR651	570	C39	449	CP149	439	CP4	422	DA4	621
BR133	472	BR652	473	C4	444	CP152	440	CP46	431	DA5	621
BR134	475	BR652	570	C40	450	CP153	441	CP47	426	DA50	641
BR135	475	BR67	468	C41	450	CP154	441	CP48	427	DA51	641
BR14	488	BR67-1	469	C42	450	CP155	441	CP49	429	DA52	641
BR140	474	BR68	468	C43	450	CP157	439	CP5	429	DA6	621
BR141	474	BR68-1	468	C45	450	CP16	428	CP50	429	DA60	641
BR142	475	BR68A	466	C46	450	CP17	428	CP56	432	DA61	641
BR146	474	BR68A	467	C48	451	CP18	429	CP57	438	DA65	642
BR15	488	BR68A-HVID	466	C5	448	CP2	426	CP58	438	DA65-4	642
BR153	473	BR68A-HVID	467	C50	435	CP200	64	CP59	434	DA7	622
BR16	489	BR68B	466	C51	435	CP200	332	CP6	423	DA70	642
BR160	476	BR68C	466	C52	447	CP200	456	CP61	434	DA71	642
BR161	476	BR68D	466	C53	447	CP201	64	CP62	434	DA72	642
BR163	476	BR68G	467	C54	447	CP201	332	CP63	434	DA73	642
BR180	477	BR68H	467	C56	452	CP201	456	CP7	427	DA8	621
BR181	477	BR68i	467	C57	452	CP202	64	CP72	433	DA9	620
BR1-M10-M20	482	BR68J	467	C59	453	CP202	332	CP72	763	DM1	631
BR1-M24	482	BR7	486	C5i	432	CP202	456	CP74	433	DM10	631
BR1-M3-M8	481	BR700	373	C5i	448	CP203	64	CP74	763	DM12	631
BR201	479	BR701	373	C6	444	CP203	332	CP75	433	DM2	631
BR212	478	BR702	373	C60	453	CP203	457	CP75	763	DM20	632
BR213	479	BR71	469	C61	453	CP204	64	CP76	432	DM21	632
BR214	212	BR71-1	469	C62	453	CP204	332	CP8	423	DM22	632
BR214	478	BR71A	470	C7	445	CP204	457	CP82	436	DM23	632
BR218	479	BR71B	470	C73	451	CP205	64	CP83	437	DM24	632
BR220	478	BR71D	470	C74	451	CP205	332	CP84	409	DM25	632
BR225	478	BR71E	470	C76	446	CP205	457	CP84	437	DM26	633
BR226	479	BR71G	470	C78	446	CP206	64	CP85	409	DM27	633
BR2-M2-M6	483	BR71I	470	C8	445	CP206	332	CP85	436	DM28	633
BR2-M8-M24	484	BR71J	470	C81	451	CP206	457	CP86	319	DM29	633
BR3	485	BR72A	471	C83	451	CP207	64	CP86	436	DM3	631
BR307	480	BR73A	471	C9	445	CP207	332	CP9	424	DM35	633
BR309	480	BR8	486	C92	451	CP207	457	CP90	439	DM36	633
BR317	478	BR9	486	C93	452	CP208	64	CP91	439	DM39	637
BR319	478	BTW1	111	C94	452	CP208	332	CP92	439	DM4	631
BR320	478	BTW2	111	C95	452	CP208	457	CP93	438	DM40	635
BR321	480	BTW3	111	C96	453	CP209	65	CP97	440	DM41	635
BR321	490	BTW4	111	CP1	422	CP209	333	CU1-1	169	DM42	635
BR322	480	C1	443	CP10	425	CP209	457	CU1-1	325	DM43	635
BR322	490	C10	445	CP100	433	CP21	430	CU1-1	463	DM44	636
BR323	479	C103	445	CP11	425	CP210	65	CV1	364	DM45	636
BR323	489	C11	445	CP12	427	CP210	333	CV2	364	DM46	636
BR324	479	C12	445	CP13	427	CP210	458	CV3	364	DM47	636
BR324	489	C123	450	CP130	437	CP211	65	CV4	365	DM48	636
BR325	480	C13	444	CP131	436	CP211	333	D1001	608	DM49	636
BR325	490	C145	732	CP132	409	CP211	458	D2001	608	DM50	636
BR327	477	C146	732	CP132	437	CP212	65	D3001	609	DM51	636
BR328	479	C15	446	CP133	437	CP212	333	D4000	609	DM52	636
BR328	489	C15G	446	CP134	437	CP212	458	D6002	609	DM53	637
BR329	472	C16	447	CP135	438	CP213	65	DA1	620	DM54	637
BR334	480	C17	447	CP136	440	CP213	333	DA10	621	DM55	637
BR334A	480	C19	448	CP137	436	CP213	458	DA12	621	DM56	637
BR335	480	C2	443	CP138	438	CP214	65	DA2	620	DM57	637
BR363	479	C20	448	CP139	438	CP214	333	DA22	622	DM58	637

DM59	637	E10480418	323	E1555	575	E283	504	E334	758	E465B	315
DM60	637	E10485418	167	E1557	575	E29	282	E336	758	E465C	315
DM61	638	E10485418	323	E1560	571	E2961	741	E337	758	E465D	316
DM63	638	E105	273	E1560-2	571	E2963	741	E338	758	E465E	316
DM64	638	E10500418	167	E1561	571	E3	281	E339	756	E465G	316
DM65	638	E10500418	323	E1562	571	E300	735	E33S	287	E465H	316
DM66	638	E105104	169	E1563	571	E300-1	736	E33S	328	E465I	316
DM67	638	E105104	325	E1565	575	E300G	737	E34	502	E465J	316
DM68	638	E10530618	168	E1567	571	E300GB	737	E341	740	E465K	316
DM69	638	E10530618	324	E1570	572	E300GP	738	E342	740	E465L	317
DM72	638	E105400607	168	E1572	572	E301	735	E35	502	E465M	317
DM73	639	E105400607	324	E1580	572	E30-1	285	E35-2	502	E465N	317
DM74	639	E10550418	169	E1581	574	E30-10	286	E35-3	503	E465O	317
DM75	639	E10550418	325	E1582	573	E301-1	736	E35-4	503	E465P	317
DM76	639	E106	273	E1583	573	E301G	737	E36	463	E465R	317
DM77	639	E106804	170	E16-10i	521	E301GB	737	E36	575	E465S	317
DM78	639	E106804	326	E16-19	521	E301GP	738	E360	766	E465T	317
DM79	639	E107	273	E16-20i	521	E302	735	E361	766	E4R	279
DM80	639	E107404	170	E16-29	202	E30-20	286	E37	504	E5	281
DM81	639	E107404	326	E16-29	522	E302-1	736	E370	670	E50	274
DM82	640	E107604	170	E16-30i	521	E30-3	285	E370	724	E51	275
DM83	640	E107604	326	E16-39	522	E30-30	286	E370	741	E5100	743
DM84	640	E10770427	170	E16-9	521	E305	737	E370	766	E5100-1	743
DM90	634	E10770427	326	E17	284	E30-5	285	E38	504	E5100-2	743
DM91	634	E107804	168	E1750	544	E306	737	E4	281	E52	275
DM92	634	E107804	324	E1751	544	E30-61	286	E400	743	E53	275
DM93	634	E108	273	E1753	544	E30-61	329	E408	742	E54	275
DM94	634	E109	273	E1757	544	E30-71	286	E409	742	E55	275
DM95	634	E11	282	E1759	544	E30-71	329	E411	773	E56	276
DM96	634	E110	273	E17R	280	E30-81	286	E412	773	E57	276
DM97	634	E11061012	170	E18	284	E30-81	329	E413	773	E58	276
DM98	635	E11061012	326	E1800	546	E30S	286	E414	773	E59	276
E1	281	E111	273	E1801	546	E30S	328	E425	314	E6	282
E10	282	E112	270	E1802	546	E31	502	E425	782	E60	276
E100	272	E113508	170	E1803	546	E310	738	E43	286	E6050	308
E100	278	E113508	326	E1810	547	E3100	743	E436	766	E6060	743
E100	286	E114215	170	E1820	547	E3107	743	E450C	312	E6060	782
E101	272	E114215	326	E1880	572	E310A	739	E455	314	E6062	766
E101	278	E114515	170	E18R	280	E311	738	E455A	314	E6063	766
E101	286	E114515	326	E19	284	E311A	739	E455B	315	E61	277
E102	272	E12	282	E19R	280	E311V	738	E455C	314	E62	277
E102	278	E1220	574	E1R	279	E312	738	E455D	314	E63	277
E102	286	E13	283	E2	281	E312A	739	E455E	315	E6310	745
E102004	169	E13	501	E20	284	E31S	287	E455G	314	E6330	745
E102004	325	E13F	283	E2090	735	E31S	328	E455H	315	E6350	745
E10220418	169	E13F	502	E2091	735	E32	502	E455J	315	E6400	745
E10220418	325	E13K	283	E2092	735	E320	739	E455M	315	E6410	745
E10230418	169	E13K	500	E2093	735	E321	757	E460	311	E6420	745
E10230418	325	E13R	283	E2094	735	E321G	757	E460A	311	E6450	745
E10240418	169	E13R	501	E20R	280	E322	756	E460B	311	E6500	746
E10240418	325	E13V	284	E21	284	E323	756	E460C	312	E6550	746
E102604	168	E13V	502	E22	284	E323-2	756	E460D	312	E6560	746
E102604	324	E14	283	E23	285	E324	758	E460DA	312	E6570	746
E10280418	168	E15	283	E23A	285	E324F	758	E460E	312	E66	274
E10280418	324	E1511	572	E24	284	E325	739	E460F	315	E6600	187
E10290418	168	E1522	572	E24A	285	E325B	739	E460G	312	E6600	745
E10290418	324	E1530	574	E24R	280	E326	758	E460H	313	E66C	275
E103	272	E1540	573	E25	285	E328	757	E460I	313	E67	277
E104	272	E1541	574	E26	285	E329	756	E460J	313	E6700	746
E104604	168	E1550	573	E26R	280	E32S	287	E460K	313	E6710	746
E104604	324	E1550-2	573	E27	285	E32S	328	E460L	313	E6720	746
E104654	168	E1551	574	E27R	280	E33	502	E460M	313	E6900	746
E104654	324	E1552	572	E28	285	E330	739	E465	317	E6910	746
E10480418	167	E1552-2	572	E282	504	E333	756	E465A	315	E6915	746

E6920	746	EA26	305	EC131C	767	EC26	292	EC99	258	ET14	501
E6R	279	EA3	298	EC131CA	267	EC27	293	ECM111	260	ET14	573
E7	282	EA4-12	304	EC131CA	768	EC28	293	ECM111-2	260	ET1900	742
E71	278	EA4-14	303	EC131K	267	EC29	289	ECM145	260	ET1901	743
E72	277	EA4-18	303	EC131K	767	EC3	288	ECM182C	260	ET1902	742
E73	278	EA4-38	303	EC131KA	267	EC30	292	ECM80RK	259	ET1903	742
E74	281	EA5	300	EC131KA	768	EC302	736	ECM81C	259	ET1904	742
E74	410	EA6-1	299	EC132	267	EC31	292	ECM82C	259	ET1905	742
E75	281	EA6-2	299	EC133C	181	EC310	738	ECM84C	260	ET2	109
E75	410	EA6-3	299	EC133C	258	EC311	738	ECM84K	259	ET2	504
E76C	276	EA6-4	299	EC134	258	EC32	294	ECM88	259	ET2949	741
E76K	276	EA6-5	299	EC135	181	EC33	293	ECM89C	260	ET2953	741
E77C	277	EA6-6	299	EC135	258	EC34	293	ECM92C	260	ET2970	741
E77K	276	EA7	301	EC137	251	EC35	293	ECM94	260	ET2980	739
E78	277	EA8	301	EC138	251	EC36	293	ECM96	260	ET2990	741
E7R	282	EA9	301	EC139	257	EC37	291	ECM97	259	ET3	109
E8	282	EC1	288	EC139K	258	EC38	288	EF81	67	ET3	504
E80	269	EC10	292	EC14	294	EC39	288	EF84	67	ET300	737
E81	269	EC100	252	EC140C	256	EC4	288	EF89	67	ET3997	741
E82	269	EC103C	252	EC140K	256	EC40	289	EF94	67	ET4	109
E83	270	EC103K	252	EC141C	256	EC41	290	EF97	67	ET4	504
E84	270	EC104K	248	EC141K	256	EC42	290	EFE31	287	ET5	109
E85	270	EC106	258	EC142C	257	EC43	290	EFK30	287	ET5	504
E86	270	EC106-2	258	EC142K	257	EC44	289	EFT31	287	ETW1	111
E87	270	EC11	292	EC143C	256	EC45	289	EG1	103	ETW10	112
E88	270	EC111	251	EC143K	255	EC46	289	EG2	103	ETW11	112
E8850	307	EC112C	252	EC144	251	EC5	289	EG3	103	ETW12	112
E8860	307	EC112K	252	EC15	291	EC50	289	EG4	103	ETW2	111
E89	271	EC113C	251	EC16	294	EC51	289	EG5	103	ETW3	111
E8952	307	EC113K	251	EC170K	250	EC52	294	EG5	104	ETW4	111
E8957	307	EC114	251	EC171C	250	EC54	294	EG6	103	ETW5	112
E8962	307	EC115	257	EC172K	253	EC55	294	EG7	103	ETW6	112
E8967	307	EC116C	257	EC173C	253	EC6	290	EG8	103	ETW7	112
E8972	307	EC116K	256	EC174K	254	EC7	290	EG9	103	ETW8	112
E8977	307	EC117	257	EC175C	254	EC8	291	EH80	334	ETW9	112
E8R	279	EC118	258	EC176K	254	EC80K	243	EH81	334	EV1	779
E9	282	EC119	246	EC177C	255	EC80RK	243	EH83	334	EV10	781
E90	271	EC12	293	EC178K	255	EC81C	243	EH84	334	EV10-2	781
E91	271	EC120C	261	EC179C	255	EC82C	244	EH85	334	EV11	781
E92	271	EC120K	261	EC18	294	EC82K	244	EH97	334	EV11-2	781
E93	271	EC121	261	EC180C	248	EC83K	243	EL1	740	EV12	781
E94	271	EC122C	264	EC181	252	EC84C	245	EL2	741	EV13	781
E96	272	EC122K	264	EC19	290	EC84K	244	EL300	737	EV14	782
E97	272	EC123C	265	EC190K	262	EC84LC	246	EO20-NC	774	EV14-2	782
E98	272	EC123K	265	EC191C	262	EC84LK	246	EO21-NC	774	EV14-3	783
E99	272	EC124	265	EC192K	262	EC85LC	245	EO21-NO	775	EV15	783
E9K	282	EC125C	265	EC193	262	EC85LK	245	EO22-NC	775	EV15-2	783
E9KR	279	EC125K	265	EC194C	263	EC87C	246	EO22-NO	775	EV16	781
E9MS	572	EC126C	268	EC194K	263	EC88	244	EO23-NC_230V	776	EV17	781
EA1	296	EC126K	268	EC196	307	EC89C	248	EO23-NC_24V	776	EV18	783
EA10	301	EC127C	268	EC197	307	EC89K	248	EO24-NC	774	EV2	779
EA11	299	EC127K	268	EC198K	308	EC8F	291	EO25	776	EV20	783
EA11	305	EC128	268	EC1F	288	EC9	291	EO26	777	EV21	651
EA13	299	EC129	258	EC2	289	EC90C	249	EO27	775	EV21	653
EA13	301	EC13	293	EC20	292	EC90K	249	EO27	776	EV21	677
EA14	304	EC130C	266	EC200	247	EC91	250	EO28	776	EV21	779
EA15	304	EC130C	767	EC201	247	EC92C	249	EO28-1	776	EV21	784
EA16	304	EC130CA	267	EC202	247	EC92K	249	EO29	776	EV22	314
EA17	304	EC130CA	767	EC203	247	EC93	250	EO30-HT	775	EV2-2	779
EA18	304	EC130K	266	EC21	291	EC94	247	EOEX27	775	EV3	780
EA2	297	EC130K	767	EC22	292	EC95	250	ET1	109	EV33	777
EA20	304	EC130KA	267	EC23	294	EC96	258	ET1	504	EV4	780
EA21	305	EC130KA	767	EC24	294	EC97	244	ET13	501	EV4-2	780
EA25	305	EC131C	267	EC25	292	EC98	252	ET13	573	EV5	651

EV5	653	FA41	322	FP2	549	GC4	179	GK155	55	J20150316	527
EV5	779	FA42	322	FP20	550	GC42	179	GK156	56	J20170316	527
EV5	784	FA43	322	FP21	550	GC43	179	GK158	56	J20180316	527
EV6	780	FA44	322	FP22	550	GC44	179	GK160	58	J20300316	526
EV6-2	780	FA5	713	FP23	551	GC45	179	GK161	58	J20310316	526
EZ1	580	FA70	722	FP24	551	GC46	185	GK165	58	J20340316	526
EZ10	581	FA71	722	FP25	551	GC47	185	GK167	58	J20350316	526
EZ11	581	FA72	723	FP26	551	GC48	181	GK168	58	J20370316	526
EZ12	581	FA73	723	FP4	550	GC49	181	GK169	58	J20380316	526
EZ12	736	FA9	722	FP5	550	GC5	179	GK170	58	J30	116
EZ2	580	FAD1	715	FP6	551	GC50	181	GK171	59	J30	537
EZ3	580	FAD20	715	FP7	549	GC50-1	184	GK173	58	J30100316	528
EZ4	580	FAD21	715	FP9	549	GC51	181	GK176	55	J30110316	528
EZ5	580	FAD-KIT	715	G110L	186	GC5-1	184	GK179	59	J30140316	528
EZ6	581	FAM1	714	G110V	186	GC51-1	184	GK182	59	J30300316	528
EZ8	581	FAM10	714	G150L	186	GC52	181	GK184	59	J30310316	528
EZ9	501	FAM11	714	G150V	186	GC52-1	184	GK198	59	J30340316	528
EZ9	581	FAPP	711	G200L	186	GC60	188	GK199	59	J40	530
F2527	412	FB1	717	G200V	186	GC61	188	GK200	60	J41	531
F2566	411	FB-1	717	G48	185	GC62	188	GK203	60	J45070402	541
F2576	413	FB-1	718	G49	185	GC63	188	GK204	60	J46	532
F2633	414	FB2	717	G50	187	GC64	188	GK36	60	J5000-FOOD	68
F2642	415	FB-2	717	G51	185	GC7	180	GK36	463	J5000-FOOD	511
FA0-1	712	FB-2	718	GC1	178	GC7	311	GK36	561	J5000-FOOD	540
FA0-1	713	FB20	717	GC10	180	GC7-1	184	GP1	567	J7020-FOOD	68
FA0-1	716	FBS4	718	GC11	180	GC8	180	GP2	567	J7020-FOOD	533
FA0-2	712	FBS40	718	GC1-1	184	GC9	180	GP3	567	J7020-FOOD	541
FA0-2	713	FF20M	714	GC13	173	GC90-1	187	H1	491	J7023-FOOD	68
FA0-2	716	FF23M	714	GC13-1	182	GC90-2	187	H1	628	J7023-FOOD	533
FA0-3	712	FF51M	714	GC14	173	GC9-1	184	H2	492	J7023-FOOD	541
FA0-3	713	FF52M	714	GC14-0	182	GG30	667	H2	629	J7024-FOOD	68
FA0-3	716	FF62M	714	GC15	173	GG33	667	H3	492	J7024-FOOD	533
FA1	710	Fi2	723	GC15-1	182	GK101	55	H3	629	J7024-FOOD	541
FA11	720	Fi2	748	GC17-1	182	GK104	55	H4	492	JA1	533
FA18-100	720	Fi2	769	GC18	174	GK116	56	H4	629	JA10B	535
FA18-10032	721	Fi20	724	GC18-0	182	GK119	56	H5	493	JA10G	535
FA18-120	720	Fi21	724	GC18-1	182	GK123	54	H5	630	JA11	531
FA18-12032	721	Fi3	723	GC19	174	GK124	54	H6	493	JA12	536
FA18-150	720	Fi4	723	GC19-1	182	GK125	54	H6	630	JA1-2	533
FA18-15032	721	Fi5	724	GC2	178	GK126	56	J00310402	523	JA14	535
FA18-20032	721	Fi6	724	GC21	175	GK127	55	J1	478	JA15	536
FA18-32	720	Fi7	723	GC22	175	GK128	55	J10100316	525	JA16	531
FA18-50	720	Fi8	723	GC22-1	183	GK129	55	J10110316	525	JA17	534
FA18-80	720	Fi9	723	GC23	175	GK130	56	J10140316	525	JA19	543
FA18-8032	721	FL10	191	GC23-1	183	GK131	57	J10150316	525	JA2	108
FA2	710	FL2	189	GC24	175	GK132	57	J10170316	525	JA2	533
FA20	711	FL3	189	GC24-1	183	GK133	59	J10180316	525	JA21	542
FA21	711	FL4	190	GC25	176	GK134	57	J10300316	524	JA23	536
FA22	713	FL5	190	GC25	319	GK135	56	J10310316	524	JA24B	538
FA23	712	FL6	191	GC26	176	GK136	56	J10340316	524	JA24G	538
FA24	712	FL7	190	GC26-1	183	GK137	56	J10350316	524	JA26	534
FA25	720	FL8	191	GC27	176	GK138	57	J10370316	524	JA28	531
FA29	321	FP1	549	GC27-1	183	GK140	57	J10380316	524	JA3	69
FA30	321	FP10	551	GC28	176	GK143	57	J10400402	334	JA3	534
FA31	322	FP11	549	GC28-1	183	GK144	57	J11	545	JA3	541
FA32	321	FP12	549	GC29	177	GK145	58	J12	532	JA32	534
FA33	322	FP13	549	GC29-1	184	GK146	57	J12-2	539	JA33	539
FA34	321	FP14	549	GC3	178	GK147	56	J17P	537	JA34	539
FA35	322	FP14-R	549	GC30	177	GK148	55	J19	530	JA4	531
FA36	321	FP15	550	GC30-1	184	GK149	54	J2	478	JA40-FOOD	68
FA37	322	FP16	550	GC31	177	GK150	54	J20	531	JA40-FOOD	540
FA38	322	FP17	550	GC3-1	184	GK152	57	J20100316	527	JA41-FOOD	68
FA39	322	FP18	550	GC31-1	184	GK153	55	J20110316	527	JA41-FOOD	540
FA40	322	FP19	550	GC32	177	GK154	54	J20140316	527	JA6	534

JA7	541	JT63	362	K4	105	MA122	126	MA205	121	MA272	353
JA8	543	JT64	144	K5	105	MA122	344	MA205	339	MA272	357
JA9	539	JT64	362	K6	105	MA123	126	MA211	123	MA273	136
JB20	599	JT65	144	K7	105	MA123	344	MA211	341	MA273	354
JB21	599	JT65	362	LA21	115	MA124	126	MA212	123	MA274	135
JB22	597	JT66	144	LB1	116	MA124	344	MA212	341	MA274	353
JB22R	597	JT66	362	LB2	117	MA125	126	MA213	123	MA275	136
JB23	596	JT67	144	LB2	396	MA125	344	MA213	341	MA275	139
JB23R	596	JT67	362	LB2	498	MA131	128	MA214	123	MA275	354
JB24	596	JT68	144	LB20	115	MA131	346	MA214	341	MA275	357
JB24R	597	JT68	362	LB21	115	MA132	128	MA215	123	MA281	124
JB25	598	JT69	144	LB22	115	MA132	346	MA215	341	MA281	342
JB26	598	JT69	362	LB3	117	MA133	128	MA221	126	MA282	124
JB27	600	JT70	144	LB3	396	MA133	346	MA221	344	MA282	342
JB28	600	JT70	362	LB3	499	MA134	128	MA222	126	MA283	124
JB29	601	JT71	144	LB4	116	MA134	346	MA222	344	MA283	342
JB30	602	JT71	362	LG1	116	MA135	128	MA223	127	MA284	125
JB31	603	JT72	145	LG2	117	MA135	346	MA223	345	MA284	343
JB32	603	JT72	363	LG2	498	MA141	130	MA224	126	MA285	125
JB33	605	JT73	145	LG2	505	MA141	348	MA224	344	MA285	343
JB34	605	JT73	363	LG2	570	MA142	130	MA225	127	MA412	137
JB35	605	JT74	145	LG3	117	MA142	348	MA225	345	MA412	355
JB37	598	JT74	363	LG3	499	MA143	130	MA231	128	MA415	137
JB45	600	JT76	145	LG3	505	MA143	348	MA231	346	MA415	355
JB48	601	JT76	363	LG3	570	MA144	130	MA232	128	MA416	137
JB49	603	JT77	145	LM20	115	MA144	348	MA232	346	MA416	355
JB62	604	JT77	363	LM22	115	MA145	130	MA233	129	MA418	137
JB63	604	JT78	145	M1	464	MA145	348	MA233	347	MA418	355
JM1	532	JT78	363	M300	141	MA161	132	MA234	128	MA511	137
JS2	545	JT80	145	M300	359	MA161	350	MA234	346	MA511	355
JS3	545	JT80	363	M301	141	MA162	132	MA235	129	MA512	137
JS4	545	JT80	530	M301	359	MA162	350	MA235	347	MA512	355
JS5	545	JT81	145	M309	141	MA163	132	MA241	130	MA513	137
JT50	134	JT81	363	M309	359	MA163	350	MA241	348	MA513	355
JT50	143	JT81	530	M310	141	MA164	132	MA242	130	MA628	138
JT50	352	K1	105	M310	359	MA164	350	MA242	348	MA628	356
JT50	361	K19	383	MA101	121	MA165	132	MA243	131	MA661	138
JT51	134	K2	105	MA101	339	MA165	350	MA243	349	MA661	356
JT51	143	K20	383	MA102	121	MA181	124	MA244	130	MA662	138
JT51	352	K21-1	382	MA102	339	MA181	342	MA244	348	MA662	356
JT51	361	K21-2	382	MA104	121	MA182	124	MA245	131	MA664	138
JT52	134	K21-3	382	MA104	339	MA182	342	MA245	349	MA664	356
JT52	143	K21-4	382	MA105	121	MA183	124	MA261	132	MA665	138
JT52	352	K22	382	MA105	339	MA183	342	MA261	138	MA665	356
JT52	361	K23	191	MA111	122	MA184	124	MA261	350	MA671	139
JT53	134	K24	625	MA111	340	MA184	342	MA261	356	MA671	357
JT53	143	K25	386	MA112	122	MA185	124	MA262	132	MA672	139
JT53	352	K25	758	MA112	340	MA185	342	MA262	138	MA672	357
JT53	361	K29	382	MA113	122	MA191	135	MA262	350	MA674	139
JT54	134	K3	105	MA113	340	MA191	353	MA262	356	MA674	357
JT54	143	K30	383	MA114	122	MA192	135	MA263	133	MA675	139
JT54	352	K31-1	382	MA114	340	MA192	353	MA263	351	MA675	357
JT54	361	K31-2	382	MA115	122	MA193	135	MA264	132	MA701	140
JT55	134	K31-3	382	MA115	340	MA193	353	MA264	350	MA701	358
JT55	143	K31-4	383	MA116	122	MA194	135	MA265	133	MA702	140
JT55	352	K31-5	383	MA116	340	MA194	353	MA265	138	MA702	358
JT55	361	K31-6	383	MA117	123	MA195	135	MA265	351	MA704	140
JT60	144	K32	383	MA117	341	MA195	353	MA265	356	MA704	358
JT60	362	K33	381	MA118	122	MA201	121	MA271	135	MA801	140
JT61	144	K34	381	MA118	340	MA201	339	MA271	139	MA801	358
JT61	362	K35	381	MA119	122	MA202	121	MA271	353	MA802	140
JT62	144	K36	381	MA119	340	MA202	339	MA271	357	MA802	358
JT62	362	K37	381	MA121	126	MA204	121	MA272	135	MA804	140
JT63	144	K38	381	MA121	344	MA204	339	MA272	139	MA804	358

MG1	108	N7-1	586	OP179	670	OP820	686	PC27	371	R5-2	384
MG2	108	N8-1	586	OP190	666	OP850	686	PC28	371	R5-4	384
MG3	108	N9-1	586	OP191	666	OP860	686	PC29	371	R5-5	384
MG4	108	OP100	664	OP192	666	OP890	686	PC3	368	R5-7	384
MG5	108	OP1000	690	OP194-FLOAT	666	OP90	648	PC30	371	R6-1	386
MG6	108	OP1002	690	OP200-NBR-H	660	OP90	658	PC31	371	R6-10	387
MG7	108	OP1004	689	OP202-NBR	660	OP900	687	PC32	372	R6-11	387
MST1	113	OP1006	689	OP204-NBR-H	662	OP901	687	PC35	372	R6-2	386
MST2	113	OP1008	691	OP206-KIT	661	OP91	648	PC37	372	R6-3	386
MST3	113	OP1010	691	OP206-NBR	661	OP91	658	PC38	372	R6-4	386
MST4	114	OP1012	692	OP208-NBR	662	OP910	688	PC4	368	R6-5	387
MST5	114	OP1014	692	OP20-EPDM	645	OP911	688	PC5	369	R6-6	387
MST6	114	OP1016	693	OP20-NBR	657	OP920	688	PC6	369	R6-7	387
MST7	114	OP1020	693	OP250-NBR-H	663	OP921	688	PC7	369	R6-8	387
MST8	114	OP1022	693	OP290	663	OP92-1	649	PC71	372	R6-9	387
N10-1	586	OP1024	694	OP292	663	OP92-1	658	PC8	369	s1001	626
N10-2	587	OP1030	694	OP300-EPDM	650	OP92-2	649	PC80	372	s1002	626
N10-3	587	OP1032	694	OP302-EPDM	650	OP92-2	659	PC80	377	s1002-1	626
N10-4	586	OP1036	695	OP304-EPDM	651	OP92-3	649	PC81	372	s1002-4	626
N10-5	587	OP1040	695	OP306-EPDM	651	OP92-3	659	PC9	369	s1002-6	626
N1-1	584	OP1042	696	OP350-EPDM	652	OP93	648	PF2642	415	s1002-7	626
N11-1	587	OP1050	696	OP352-EPDM	653	OP94	649	PG1	374	s1004-1	625
N11-4	587	OP10-EPDM-H	645	OP354-EPDM	653	OP94	659	PG10	375	S1005	627
N1-2	585	OP10-NBR-H	656	OP358-EPDM	652	OP95	649	PG13	376	s1005-1	627
N12-1	587	OP110	664	OP360-EPDM	654	OP95	659	PG18	375	s1006-1	627
N12-2	587	OP1110	697	OP390	654	PA100	212	PG2	374	s1006-3	625
N12-3	587	OP1112	697	OP40-EPDM	646	PA25	233	PG22	376	s1006-4	625
N1-3	585	OP1114	698	OP42-EPDM	646	PA26	233	PG27	376	s1006-5	625
N13-1	588	OP1116	698	OP44-EPDM	647	PA27	233	PG28	376	s1006-6	625
N13-2	588	OP1118	698	OP46-EPDM	647	PA28	233	PG29	376	s1006-7	627
N13-3	588	OP11-NBR-H	656	OP50-EPDM	646	PA29	233	PG3	374	s1006-8	625
N1-4	585	OP120	665	OP514-24V	674	PA30	233	PG30	377	S1010	311
N14-1	590	OP1200	699	OP516-24V	674	PA31	234	PG31	377	S1010	319
N14-2	590	OP1202	699	OP518-230V	675	PA35	234	PG4	375	S1010	523
N14-3	590	OP1204	700	OP520-230V	675	PA36	234	PG43	375	S1010	783
N14-4	590	OP121	665	OP522	673	PA38	234	PG6	375	SAF8063	223
N14-5	590	OP130	668	OP524	673	PA39	234	PG7	375	SAF8063	417
N14-6	590	OP1302	705	OP530-24V	674	PA45	236	PG9	375	VS10	335
N14-7	590	OP1304	705	OP532-230V	674	PA49	236	PR60	378	VS4	335
N15	590	OP1306	706	OP534	673	PA50	236	PR61	378	VS5	335
N16-1	591	OP1308	706	OP552	676	PA54	237	PR62	378	VS6	335
N16-2	591	OP1310	703	OP554	676	PA55	237	PR64	378	AA1	748
N16-3	591	OP1314	701	OP570	677	PA57	237	PR66	378	AA2	748
N16-4	591	OP1316	702	OP572	677	PA60	237	PR67	378	AA3	748
N16-5	591	OP135	667	OP574	677	PA65	237	PTW4	112	AA381	759
N16-6	591	OP140	667	OP576	677	PA65	239	R1	381	AA382	759
N16-7	591	OP140	765	OP578	677	PA70	238	R2	380	AA383	759
N17	594	OP1408	707	OP600	678	PA72	238	R21	385	AA384	759
N18	544	OP1409	707	OP60-EPDM	647	PA74	238	R2-1	380	AA385	759
N18	594	OP1410	708	OP610	678	PA78	238	R22	385	AA4	748
N18-2	544	OP1418	708	OP620	679	PA79	238	R2-2	380		
N18-2	594	OP1419	708	OP630	679	PA90	237	R23	385		
N19	587	OP1420	708	OP640	680	PA90	239	R24	385		
N20	584	OP144	668	OP650	680	PC1	368	R25	385		
N21	584	OP144	765	OP660	680	PC1	463	R26	385		
N2-1	585	OP150	668	OP690	681	PC10	369	R27	385		
N2-2	585	OP150	764	OP692	681	PC13	370	R28	385		
N2-3	585	OP152	669	OP700-EPDM	684	PC14	370	R29	386		
N3-1	585	OP152	764	OP720-EPDM	682	PC18	370	R3	381		
N4-1	585	OP160	668	OP721-EPDM	683	PC19	370	R4	381		
N5-1	585	OP170	669	OP730-EPDM	683	PC2	368	R4-2	382		
N5-2	586	OP170-B	670	OP731-EPDM	684	PC20	370	R4-3	381		
N5-3	586	OP172	669	OP800	685	PC21	370	R4-4	382		
N6-1	586	OP172-B	670	OP810	686	PC23	370	R4-5	382		

STØRRELSESGUIDE

SLANGESTØRRELSER		SVEJSEFITTINGS		DN	Tommer	MM
"	mm indv.	"	mm	DN	"	mm
1/8"	4	1/8"	10,2	6	1/8"	10,2
3/16"	5	1/4"	13,5	8	1/4"	13,5
1/4"	6	3/8"	17,2	10	3/8"	17,2
5/16"	8	1/2"	21,3	15	1/2"	21,3
3/8"	10	3/4"	26,9	20	3/4"	26,9
1/2"	12,5	1"	33,7	25	1"	33,7
5/8"	16	1 1/4"	42,4	32	1 1/4"	42,4
3/4"	19	1 1/2"	48,3	40	1 1/2"	48,3
1"	25	2"	60,3	50	2"	60,3
1 1/4"	32	2 1/2"	76,1	65	2 1/2"	76,1
1 1/2"	38	3"	88,9	80	3"	88,9
2"	52	4"	114,3	100	4"	114,3
2 1/2"	62	5"	139,7	125	5"	139,7
3"	77	6"	168,3	150	6"	168,3
4"	102	8"	219,1	200	8"	219,1
5"	127	10"	273,1	250	10"	273,1
6"	153	12"	323,9	300	12"	323,9

TRYKTABEL FOR GEVINDRØR ANGIVET I BAR

Vores gevindrør er i **AISI 316 rustfri syrefast stål**. Udregningen er baseret på DIN2413 WR 1.4401. Her har du en PDF tabel, hvor du kan se, hvad de kan tåle af tryk, ved forskellige temperaturer:

Rørdim.	mm	- - gods	20°C	100°C	150°C	200°C	250°C	300°C	350°C	400°C
1/4"	13,5	2,24	463	451	426	417	398	374	356	342
3/8"	17,2	2,30	373	348	331	325	306	288	275	265
1/2"	21,3	2,65	347	319	307	299	282	264	253	243
3/4"	26,9	2,65	219	244	244	229	215	202	194	186
1"	33,7	3,25	269	239	239	224	210	197	189	182
1 1/4"	42,4	3,25	214	188	186	174	163	153	146	140
1 1/2"	48,3	3,25	188	165	162	150	141	133	128	122
2"	60,3	3,65	169	149	144	134	127	118	114	109
2 1/2"	76,1	3,60	132	116	100	104	98	92	87	84
3"	88,9	4,05	127	112	107	99	93	88	84	81

GEVIND BESKRIVELSER

DER FINDES 2 TYPER RØRGEVIND

- PARALLEL OG KONISK.

1. Parallel rørgvind som sædvanligvis anvendes, når tætning **ikke er** på gevindet.
2. Konisk rørgvind som sædvanligvis anvendes, når tætning **er** på gevindet.

DER FINDES 2 SYSTEMER FOR RØRGEVIND - BRITISK (WHITWORTH 55°) OG AMERIKANSK (60°)

1. Whitworth, ud over at have en flankevinkel på 55°, har 4 standard stigninger - 28, 19, 14 og 11 TPI
2. Amerikansk, ud over at have en flankevinkel på 60°, har 5 standard stigninger - 27, 18, 14, 11½ og 8 TPI

Den første vigtige ting at bemærke er, at diameteren (d/D) på et rørgvind er ikke den faktiske diameter.

Den diameter som angives, er baseret på røret's indvendige diameter, da det er røret's indvendige diameter (hul) der er væsentlig. For eksempel er den faktiske diameter på et 1" Whitworth rørgvind ikke $1 \times 25,4 = 25,4\text{mm}$ - men **33,25mm** og en 1" amerikansk rørgvind ikke $1 \times 25,4 = 25,4\text{mm}$ - men **33,40mm**.

Derfor bør man altid checke den relevante norm for de korrekte mål.

Da Whitworth rørgvind er mere enkel (efter min mening), end den amerikanske (og mere anvendt i Europa), tages dette gevindtype først.

WHITWORTH (PARALLEL) RØRGEVIND REF. ISO 228-1

(BSP = British Standard Pipe)

Dette gevind har følgende anerkendte betegnelser (forkortelser) : **G, BSP**

Et indvendigt gevind har kun én toleranceklasse, men det udvendige gevind har to - **A** og **B**. Det indvendige gevinds delediameter tolerance er den samme som **A** i det udvendige gevind, og tolerance **B** er nøjagtig dobbelt så stor som **A**.

I standarden ISO 228-1 angives de korrekte betegnelser ved, for eksempel en 1½ rørgvind som følger :

Indvendigt gevind **ISO 228-G 1½** og udvendigt gevind **ISO 228-G 1½ A** eller **ISO 228-G 1½ B** afhængig af den valgte tolerance.

Delediameter tolerancen på et udvendigt gevind er altid fra nominal og minus og for et indvendigt gevind fra nominal og plus. I teori kan de begge (udvendigt og indvendigt) have nøjagtigt den samme delediameter mål - nemlig nominal.

WHITWORTH (KONISK) RØRGEVIND REF. ISO 7-1

(BSPT = British Standard Pipe Taper)

Dette gevind har følgende anerkendte betegnelser (forkortelser) : **R, Rc, Rp, BSPT**

Et indvendigt gevind kan enten være parallel eller konisk. For eksempel ved en 1½" rørgvind.

- Et indvendigt og parallel rørgvind har betegnelsen **ISO 7 - Rp 1½**
- Et indvendigt og konisk rørgvind har betegnelsen **ISO 7 - Rc 1½**
- Et udvendigt gevind er altid konisk og har betegnelsen **ISO 7 - R 1½**

Delediameter tolerancen på et konisk gevind svarer størrelsesmæssigt cirka til **B** tolerancen på et parallel rørgvind. For mere information om denne anbefales at der læses normen ISO 7-1 eller side 3.06 af FMS gevindhåndbog CD.

AMERIKANSK (NP) RØRGEVIND

Der er betydeligt flere typer Amerikansk rørgvindtyper, end der er Whitworth. Der kan derfor kun gives lidt generel information om disse. Det anbefales, at den relevante standard anvendes ved specificering, fremstilling og/eller kontrol.

Anvendte forkortelser i angivelsen af amerikansk rørgvindtyper:

ENGELSK	DANSK
N National Standard	National Standard
P Pipe	Rør
T Taper	Konisk
C Coupling	Kobling
S Straight	Parallel
M Mechanical	Mekanisk
L Locknut	Låsemøtrik
H Hose Coupling	Slangekobling
R Railing Fitting	Skinne Fitting
F Fine	Fin

Nogle gevindbetegnelser (forkortelser) for Amerikansk parallel rørgvind.

NPSI, NPSM, NPSL, NPSH, NPSF, NPSI

Nogle gevindbetegnelser (forkortelser) for amerikansk konisk rørgvind.

NPT, NPTR, NPTF

NOMINELLE DIAMETRE KONTRA TOMMES GEVIND/STØRRELSER

Ø	Dim
16	3/8"
20	1/2"
25	3/4"
32	1"
40	1 1/4"
50	1 1/2"
63	2"
75	2 1/2"
90	3"
110	4"

MATERIALEBETEGNELSER

FORKORTEELSE	MATERIALE	BETEGNELSE
Acryl	plast	Polyacryl (plexiglas)
ALU	metal	Aluminium
EPDM	gummi	Ethylene Propylene Diene Monomer
HD teflon	plast	High Density teflon
Hypalon®	gummi	Dupont chlorosulfonated polyethylene
LD teflon	plast	Low Density teflon
MD teflon	plast	Medium Density teflon
MS	metal	Messing
NBR	gummi	Nitrile Butadiene Rubber
Nylon	kunstoffibre	Polyamider
PA	plast	PolyAmid (nylon)
PBT	plast	PolyButylene Terephthalate
PC	plast	PolyCarbonat
PE	plast	PolyEthylen
PEM	plast	PolyEthylen Monomer
PEX	plast	Cross-linked polyethylene
POM	plast	Polyacetal (acetal)
PP	plast	PolyPropylen
PTFE	teflon	PolyTetraFluoroEthylen
PU	plast	PolyUrethan
PVC	plast	PolyVinylClorid
PVDF	plast	PolyVinylidene Fluoride (teflon)
RS304	metal	Rustfri Stål AISI 304
RS316	metal	Rustfri Stål AISI 316
SAN	plast	Styrene AcryloNitrile
SBR	plast	Styrene Butadiene Rubber
VITON®	gummi	Dupont fluoroelastomer

PIKTOGRAMFORKLARING



Tryk



Temperatur



Standarder



Certifikater



Godkendt til drikkevand (VA)

RESISTENSLISTE

Beskrivelse (% , °C)	Messing	SUS 304	Acetal	PBT	PP	NBR	EPDM
Kaustisk soda (10%,20°C)	2	2	4	2	3	3	4
Benzin	3	3	4	4	2	4	1
Myresyre (25%,20°C)	1	2	1	3	4	3	4
Luft	4	4	4	4	4	4	4
Miniralsk olie	3	3	4	4	3	4	1
Fedt	3	4	4	4	2	4	1
Natrium silikat	3	0	4	3	4	4	4
Glycerin	3	4	4	4	4	4	4
Ozon	3	3	2	4	2	3	4
Animalsk olie	3	0	4	4	3	4	3
Petroleum	4	4	4	4	4	4	1
Methan	3	0	4	4	4	4	1
Methanol	4	2	3	3	3	4	4
Vand (24°C)	3	3	4	3	4	4	4
Vand (100°C)	1	3	2	1	2	0	0
Salt vand	2	3	4	3	4	0	0
Bunkerolie	2	0	0	0	3	4	0
Benzen	1	2	3	3	2	1	1
Butan	4	4	4	4	4	4	1
Fluor	1	1	1	0	1	0	2
Borsyre	3	3	3	3	4	4	4
Tetrachlormethan	2	2	3	3	2	2	1
Oxygen	4	4	3	3	3	3	4
Petroleum	0	0	3	3	1	4	1
Soda (natriumcarbonat)	3	2	4	3	4	4	4
Calciumhydroxid	2	2	4	1	3	4	4
Hydrogen	2	4	4	4	4	4	4
Kviksølv	1	0	0	0	4	4	4
Damp (150°C)	3	0	2	2	1	1	4
Natriumcyanid	1	0				4	4
Vegetabilsk olie	0	0	3	3	3	4	4
Silicone fedt	0	0	4	4	2	4	4
Silicone olie	0	0	4	4	2	4	4
Acetone	4	2	3	3	2	1	4
Svovlsyrling	0	0	2	3	3	3	3
Ammoniak	2	4	3	2	3	4	4
Flydende petroleum	4	4	4	4	3	4	1
Ethyl alkohol (Ethanol)	4	3	4	4	3	4	4

Meget acceptabelt	4
Acceptabelt	3
Let acceptabelt	2
Uacceptabelt	1
Ingen data	0

RESISTENSLISTE

Beskrivelse (% , °C)	Messing	SUS 304	Acetal	PBT	PP	NBR	EPDM
Lud opløsning	0	0	4	3	3	3	4
Saltsyre (10%,20°C)	1	1	1	3	4	0	0
Saltsyre (20%,20°C)	1	1	1	2	3	0	0
Saltsyre (20%,80°C)	1	1	1	1	1	1	2
Saltsyre (38%,20°C)	1	1	1	2	3	3	4
Ammoniumchlorid	1	2	4	3	4	4	4
Calciumchlorid	3	2	4	3	4	4	4
Naphtha	2	3	4	3	2	2	1
Oliven olie	2	4	3	4	3	4	3
Svovl	1	3	4	0	4	1	4
Natriumfosfat	1	2	4	3	4	4	4
Ammoniumfosfat	2	2	4	3	4	4	4
Ammonium nitrat	1	3	3	3	4	4	4
Nitrogen	3	4	4	3	4	4	4
Natur gas	4	4	4	4	3	4	1
Eddikesyre (10%,20°C)	1	3	2	3	4	3	4
Eddikesyre (50%,20°C)	1	3	1	3	3	0	0
Eddikesyre (50%,70°C)	1	3	1	2	1	0	0
Eddikesyre (100%,20°C)	1	2	1	3	1	0	0
Ketoner	3	3	3	3	4	0	3
Kresol	3	2	2	3	3	2	1
Chromsyre (2%,70°C)	1	1	1	1	2	0	0
Chromsyre (10%,70°C)	1	1	1	1	1	0	0
Chromsyre (25%,70°C)	1	1	1	1	1	0	0
Chromsyre (2%,50°C)	1	1	1	2	2	1	3
Sojaolie	2	3	4	4	3	4	2
Toluen	4	4	3	2	2	1	1
Glucose	4	4	4	4	4	4	4
Propan	4	4	4	4	4	4	1
Ricinusolie	3	3	3	3	4	4	3
Svovlsyre (10%,20°C)	1	1	1	3	3	1	3
Svovlsyre (10%,70°C)	1	1	1	1	2	0	0
Svovlsyre (30%,20°C)	1	1	1	2	3	0	0
Svovlsyre (30%,70°C)	1	1	1	1	2	0	0
Svovlsyre (98%,20°C)	1	1	1	1	1	0	0
Aluminum sulfat	1	3	4	3	4	4	4
Kalium sulfat	3	2	4	3	4	4	4
Hydrogensulfid	2	2	3	3	4	1	4

Meget acceptabelt	4
Acceptabelt	3
Let acceptabelt	2
Uacceptabelt	1
Ingen data	0

ALFABETISK INDHOLDSFORTEGNELSE

000001-G	561	000291-G	566	045095	164	449117804	742	744950006	593	A21	199
000001-S	554	000291-S	558	045095-20	166	449118804	742	744950022	107	A21C	199
000002-G	561	000300-G	566	045096	164	743171509	579	744950022	593	A2-1PP	515
000002-S	554	000300-S	559	045096-20	166	743523104s	738	774545050	635	A22	199
000003-G	561	000310-G	566	045120	163	743523104	738	8815A	546	A2-2PP	515
000010-G	561	000310-S	559	045121	164	744700017	503	8815RS	546	A23	198
000010-S	554	000340-G	567	045121-20	166	744704001	500	A1	506	A24	199
000020-G	561	000340-S	559	045123	164	744705002	503	A10	507	A25	199
000020-S	554	000341-G	567	045123-20	166	744707002	503	A101PP	515	A26	199
000040-G	562	000341-S	559	045130	164	744711000	503	A10-1PP	516	A27	142
000040-S	554	000471-G	567	045130-20	166	744712020	501	A102PP	516	A27	360
000041-G	562	000529-G	567	045160	163	744808004	106	A10-2PP	516	A28-1	142
000041-S	554	000529-S	559	045160-20	166	744808004	592	A105PP	517	A28-1	360
000060-G	563	000685	700	045163	164	744808006	106	A106PP	517	A28-2	142
000085-G	563	000685	416	045165	163	744808006	592	A109	517	A28-2	360
000085-S	555	012030103	559	045165-20	166	744808036	107	A109-2	517	A28-3	142
000090-G	562	012030104	559	045170	163	744808036	593	A10C	507	A28-3	360
000090-G2	562	012030403	568	045170-20	166	744809004	106	A10T	510	A29	747
000090-S	555	012030404	568	045180	164	744809004	592	A11	604	A29-20	769
000090-S2	555	012040102	559	045-1882	576	744809036	106	A112-1	519	A2C	507
000092-G	562	012040106	560	045-1975	576	744809036	592	A112-16	519	A2C-2	516
000092-G2	562	012040108	560	045-1985	576	744810004	106	A1-1PP	514	A2C45	516
000092-S	555	012040402	568	047082	164	744810004	592	A12	507	A2CS	516
000092-S2	555	012040406	568	047082	166	744810006	107	A120	194	A2T	510
000096-G	563	012040408	568	048090	578	744810006	593	A121	194	A3	508
000096-S	555	012060110	560	048092	578	744811006	106	A122	194	A30-2	747
000098-G	563	012060111	560	048094	578	744811006	592	A123	194	A30-3	85
000098-S	555	012060401	568	048130	578	744812003	106	A126	194	A30-3	747
000120-G	563	012060410	569	048240	579	744812003	592	A127	195	A30-4	747
000120-S	555	012060411	569	048241	579	744812004	106	A128	195	A30-5	85
000121-G	563	012080112	560	048245	578	744812004	592	A128G	195	A30-5	747
000121-S	555	012080113	560	048270	579	744812024	107	A129	197	A30-50	747
000130-G	563	012080114	560	048280	578	744812024	593	A129	517	A30-60	747
000130-G2	564	012080412	569	048291	579	744812034	107	A1-2PP	514	A3-1PP	518
000130-S	556	012080413	569	070612	149	744812034	593	A13	517	A32-1	749
000130-S2	556	012080414	569	070612	464	744812036	107	A130	195	A32-2	749
000131-G	563	012100116	560	072-1475	149	744812036	593	A131	195	A328	773
000131-S	556	012100416	569	072-3460	148	744816004	106	A132	196	A3-2PP	518
000165-G	563	013270-G	566	072-3461	148	744816004	592	A133	195	A330PP	769
000165-S	556	013270-S	558	072-3462	148	744816006	106	A133-2	196	A34	199
000180-G	564	044020	161	072-3463	148	744816006	592	A134	196	A35	201
000180-S	556	044021	161	072-3464	148	744816022	106	A134-2	196	A36	201
000221-G	564	044023	161	072-3465	148	744816022	592	A135	196	A36L	201
000221-S	556	044030	161	072-3466	149	744816034	107	A137	196	A37	201
000223-G	564	044030R	161	072-3467	149	744816034	593	A139	197	A38	201
000223-S	557	044037	162	072-3469	149	744816036	107	A139	517	A39	201
000240-G	565	044040	162	072-3471	149	744816036	593	A139	521	A390	748
000240-S	557	044054	162	087251015	165	744818004	106	A14	198	A4	508
000241-G	565	044060	160	087251022	166	744818004	592	A140	522	A40	201
000241-S	558	044065	160	418117	736	744818036	107	A141	195	A400	515
000245-G	565	044070	160	418118	736	744818036	593	A15	198	A41	202
000245-S	557	044070R	160	418119	736	744818056	107	A155	539	A4-1PP	518
000246-G	566	044080	162	418120	736	744818056	593	A16	198	A42	202
000246-S	558	044093	162	271302508	627	744841324	107	A17	198	A4-2PP	518
000270-G	566	044094	162	405000003	575	744841324	584	A18	198	A43	202
000270-S	558	044095	162	405000103	575	744850050	107	A19	199	A44	202
000280-G	565	044096	162	405001003	575	744850050	593	A1F	506	A45	202
000280-S	557	044163	161	405001106	575	744950004	107	A1T	510	A46	202
000290-G	566	045036	164	410082004	741	744950004	593	A2	507	A47	202
000290-S	558	045037	164	430377004	768	744950006	107	A20	199	A48	203

A48	723	AC35	204	AD99	84	AL4	215	AR16	226	AV5	794
A48-2	203	AC40	204	AD99	210	AL5	217	AR18	226	AV6	794
A48-2	723	AC43	204	AF8063	222	AL50	213	AR2	224	AV7	794
A49	201	AD105C	83	AF8063	417	AL50	221	AR22	226	AV8	795
A4T	510	AD105C	209	AFB8063	223	AL50	231	AR28	226	AV9	796
A5	508	AD105K	83	AFB8063	417	AL51	213	AR29	226	B0	391
A50	508	AD105K	209	AFL2633	223	AL51	221	AR30	227	B1	390
A50PP	519	AD108	83	AFL2633	418	AL51	231	AR46	227	B10	393
A51-1PP	197	AD108	209	AFNV2642	416	AL52	214	AR5	224	B105	65
A51-2PP	197	AD109	83	AFNV2642C	416	AL52	221	AR6	225	B105	333
A51-6PP	197	AD109	209	AFR2633	223	AL52	231	AR69	769	B105	457
A51-7PP	197	AD110	83	AFR2633	418	AL5U	217	AR70	753	B10L	403
A51-8PA	197	AD110	209	AFV33	752	AL5Y	217	AR70	770	B11	394
A51PP	519	AD111	83	AG1	104	AL6	217	AR71	753	B111	141
A52	202	AD111	209	AG2	104	AL60	222	AR72	753	B111	359
A53PP	519	AD112	83	AG3	104	AL61	222	AR9	225	B112	141
A5PP	518	AD112	209	AG4	104	AL6-1	218	AR98	227	B112	359
A5T	510	AD113	84	AH1	754	AL6-2	218	AR99	225	B12	394
A6	507	AD113	210	AH16	227	AL6-3	218	ARL1	228	B1-2	390
A60	150	AD113	769	AH16	755	AL69	769	ARL1F	228	B12-2	394
A61	151	AD115	84	AH17	237	AL6-O	218	ARL2	229	B12L	403
A6-1PP	517	AD115	210	AH17	755	AL7	216	ARL22	230	B12NPT	408
A62	151	AD116	84	AH18	221	AL70	753	ARL22F	230	B12S	394
A6-2PP	518	AD116	210	AH18	755	AL70	770	ARL29	231	B14	395
A63	151	AD120	84	AH19	771	AL71	753	ARL29F	231	B14	497
A64	152	AD120	210	AH2	754	AL72	753	ARL2F	229	B14G	396
A65	153	AD120	748	AH20	771	ALV33	751	ARL30	231	B14G	498
A66	152	AD121	84	AH21	771	ALV33-1	751	ARL31	230	B14i	395
A67	153	AD121	210	AH22	772	AM60	158	ARL5	229	B14i	497
A68	153	AD122	84	AH23	772	AM61	158	ARL6	229	B14L	403
A69	153	AD122	210	AH24	755	AM62	158	ARL8	229	B14NPT	408
A6T	510	AD122	769	AH25	755	AM63	158	ARL98	228	B14S	396
A7	508	AD123	84	AH28	772	AM64	158	ARL98-1	227	B14S	498
A70	154	AD123	210	AH29	752	AM65	158	ARL99	227	B14U	400
A71	152	AD125	84	AH3	754	AM66	158	ARV33	751	B14V	395
A72	155	AD125	210	AH4	754	AM67	159	ARV33-1	751	B14V	497
A7-2	508	AD126	84	AH5	755	AM68	159	ARV33-2	751	B15	395
A73	156	AD126	210	AH6	755	AM69	159	AS10	509	B15L	403
A74	152	AD80	81	AH7	755	AM70	159	AS106	509	B17	395
A75	151	AD80	207	AHX	752	AM71	158	AS2	509	B17L	403
A76	153	AD81	81	AJ1	150	AM76	159	AS9	509	B18	394
A78	154	AD81	207	AJ1	464	AN10M	513	ATW3	112	B18L	403
A79	151	AD82	81	AJ5	464	AN14B	512	ATW4	112	B19	400
A7PP	519	AD82	207	AL1	215	AN14C	513	AV1	792	B19L	404
A7T	511	AD83	81	AL14	217	AN14D	512	AV10	796	B1L	402
A8	508	AD83	207	AL16	218	AN14L	512	AV11	797	B1NPT	408
A80	152	AD84	81	AL17	218	AN46	512	AV12	797	B2	390
A81	152	AD84	207	AL18	219	AN46M	513	AV13	797	B20	400
A8-1PP	519	AD85	82	AL19	220	AN47	512	AV14	798	B20L	404
A82	154	AD85	208	AL2	216	AP1	212	AV15	798	B20S	400
A8-2PP	519	AD86	82	AL20	221	AP1	464	AV16	799	B21	405
A83	154	AD86	208	AL22	219	AP1-1	212	AV17	800	B22	406
A84	154	AD88	82	AL2-2	216	AP1-1	463	AV18	800	B2-2	391
A85	154	AD88	208	AL28	220	AP4	212	AV19	801	B22NPT	409
A86	154	AD90	82	AL3	216	AP4	464	AV2	793	B23	405
A8T	511	AD90	208	AL300L	752	AP6	212	AV20	802	B24NB	405
A9	508	AD95	83	AL300T	752	AP6	463	AV21	802	B25	407
A9-1PP	518	AD95	209	AL33	751	APT1	212	AV22	802	B25L	404
A9-2PP	518	AD96	82	AL33VIT	751	APT1	464	AV23	803	B26	406
A9T	511	AD96	208	AL340	229	AR1	224	AV24	803	B26L	404
AB14	520	AD97	82	AL340	567	AR10	225	AV25	796	B27	405
AB46	520	AD97	208	AL341	229	AR12	225	AV26	802	B28	393
AB60	205	AD98	82	AL341	567	AR14	225	AV3	793	B28L	403
AB61	205	AD98	208	AL38	215	AR15	226	AV4	793	B28NPT	409

B29	393	B36	462	B62M	95	B89C	63	BFP	397	BP30B	615
B2L	402	B36-2	462	B62N	99	B89C	331	BG1	102	BP30C	71
B2NPT	408	B370S304	761	B62PP	97	B89C	456	BG2	102	BP30C	615
B3	391	B370S316	761	B63	89	B89K	63	BG3	102	BP30D	71
B3100	732	B38	392	B63A	93	B89K	331	BG4	102	BP30D	615
B320	728	B39H	732	B63-LOCK	91	B89K	456	BG5	102	BP30E	71
B32A-REDU	727	B3L	402	B63M	95	B8B7	398	BG5	103	BP30E	615
B32B	728	B4	391	B63N	99	B8L	403	BG5	104	BP32	72
B32C	728	B40S	329	B63PP	97	B8NPT	410	BG6	102	BP32	616
B32L	404	B40S	401	B64	89	B8S	399	BH33	728	BP32A	72
B32-REDU	727	B41S	329	B64	91	B9	392	BH33-1	728	BP32A	616
B33	671	B41S	401	B64A	93	B90	764	BH8	397	BP32B	72
B33	727	B42S	287	B64M	95	B90-2	764	Bi68	480	BP32B	616
B33-22	672	B42S	329	B64N	99	B92	765	Bi69	472	BP32C	72
B33-22	729	B43S	329	B64PP	97	B94	63	Bi69-2	472	BP32C	616
B33-22A	729	B43S	401	B65	88	B94	331	Bi72	477	BP32D	72
B33-22-ISO	672	B44S	329	B65	90	B94	456	BJ1	419	BP32D	616
B33-22-ISO	728	B44S	401	B65A	92	B97	63	BJ2	419	BP33	74
B33-22L	404	B45S	329	B65M	94	B97	331	BJ3	419	BP33	618
B33-42	729	B45S	401	B65N	98	B97	456	BK35	422	BP33A	74
B33-42-ISO	672	B46	395	B65PP	96	B98	63	BK35	443	BP33A	618
B33-42-ISO	729	B46	498	B66	89	B98	331	BK35	462	BP33B	74
B33-52	729	B460D	319	B66A	93	B98	456	BK36	462	BP33B	618
B33-52-ISO	672	B460E	319	B66-LOCK	91	B9L	403	BL3	732	BP33H	74
B33-52-ISO	729	B47	409	B66M	95	B9NPT	408	BL5	401	BP33H	618
B33ACDA	784	B47	438	B66N	99	BA1	762	BP0	72	BP4	76
B33ACSR	784	B4L	402	B66PP	97	BC21	405	BP0	616	BP4	610
B33AIR-4C	789	B4NPT	408	B67	89	BC22	406	BP1	70	BP40	75
B33AIR-4V	789	B5	391	B67	91	BC22-NPT	409	BP1	614	BP40	619
B33AIR-D4C	789	B5L	402	B67A	93	BC25	406	BP12	77	BP41	75
B33AIR-D4V	789	B5U	391	B67M	95	BC25-304	406	BP12	473	BP41	619
B33AIR-DA	788	B5UL	402	B67N	99	BE31	499	BP12	611	BP42	75
B33AIR-L	789	B5V	392	B67PP	97	BE32	499	BP12L	77	BP42	619
B33AIR-M	789	B5V-1	392	B6B7	398	BE33	499	BP12L	473	BP5	76
B33AIR-NC	788	B5V-2	392	B6L	403	BE35	499	BP12L	611	BP5	610
B33AIR-NO	788	B5V-3	392	B6S	399	BE36	499	BP14	79	BP61	78
B33AIR-SEAT	789	B5Y	392	B7	398	BE51	66	BP14	473	BP61	612
B33AIRV-DA	790	B6	397	B70-1	761	BE51	459	BP1A	70	BP62	78
B33AIRV-NC	790	B60	88	B70-2	761	BE54	66	BP1A	614	BP62	612
B33AIRV-NO	790	B60	90	B70-3	761	BE54	459	BP1B	70	BP63	79
B33B	727	B6050	308	B70-4	761	BE55	66	BP1B	614	BP63	613
B33EL	786	B60A	92	B71	762	BE55	459	BP1C	70	BP64	79
B33EL-1	786	B60M	94	B72	762	BE56	66	BP1C	614	BP64	613
B33EL-2	785	B60N	98	B73	762	BE56	459	BP1D	70	BP70	74
B33EL-3	786	B60P-1	100	B74	762	BE58	66	BP1D	614	BP70	618
B33EL-4	786	B60P-10	101	B75	399	BE58	459	BP1E	70	BP73	75
B33EL-5	786	B60P-2	100	B8	397	BE59	66	BP1E	614	BP73	619
B33EL-6	786	B60P-3	100	B80	62	BE59	459	BP2	73	BP74	75
B33EL-7	785	B60P-4	100	B80	330	BE60	66	BP2	617	BP74	619
B33EL-A	776	B60P-5	100	B80	455	BE60	459	BP2A	73	BP8	76
B33-ISO	728	B60P-6	100	B81	62	BE71	66	BP2A	617	BP8	610
B33L	404	B60P-7	101	B81	330	BE71	459	BP2B	73	BP80	75
B33-LOCK	671	B60P-8	101	B81	455	BF14U	400	BP2B	617	BP80	619
B33-LOCK	727	B60P-9	101	B82	63	BF19	401	BP2C	73	BP81	75
B33N	727	B60PP	96	B82	330	BF20	401	BP2C	617	BP81	619
B33SH	730	B61	89	B82	455	BF20S	400	BP2E	73	BP82	75
B34	732	B61A	93	B84	63	BF6	397	BP2E	617	BP82	619
B34-24	731	B61-LOCK	91	B84	330	BF6B7	398	BP3	76	BP9	77
B34F	732	B61M	95	B84	455	BF6S	399	BP3	610	BP9	611
B34G	731	B61N	99	B86	63	BF7	398	BP30	71	BP9-2	77
B34GV	731	B61PP	97	B86	331	BF7S	399	BP30	615	BP9-2	611
B34SH	730	B62	89	B86	455	BF8	397	BP30A	71	BR10	486
B36	422	B62A	93	B8850	308	BF8B7	398	BP30A	615	BR101	476
B36	443	B62-LOCK	91	B8952	308	BF8S	399	BP30B	71	BR102	476

BR103	477	BR373	479	C21	448	CP14	428	CP214	458	DA25	621
BR104	477	BR374	479	C22	448	CP140	438	CP23	431	DA26	621
BR11	487	BR5	486	C24	447	CP142	439	CP25	431	DA3	620
BR114	473	BR570	480	C28	450	CP14-2	428	CP26	432	DA30	582
BR115	472	BR6	486	C3	444	CP144	439	CP27	432	DA31	582
BR117	472	BR603	472	C31	446	CP145	439	CP3	428	DA32	582
BR12	487	BR650	473	C35	449	CP146	440	CP30	432	DA33	582
BR123	476	BR650	570	C36	449	CP147	440	CP35	430	DA34	582
BR127	477	BR651	473	C38	446	CP148	440	CP39	430	DA39	582
BR13	487	BR651	570	C39	449	CP149	439	CP4	422	DA4	621
BR133	472	BR652	473	C4	444	CP152	440	CP46	431	DA5	621
BR134	475	BR652	570	C40	450	CP153	441	CP47	426	DA50	641
BR135	475	BR67	468	C41	450	CP154	441	CP48	427	DA51	641
BR14	488	BR67-1	469	C42	450	CP155	441	CP49	429	DA52	641
BR140	474	BR68	468	C43	450	CP157	439	CP5	429	DA6	621
BR141	474	BR68-1	468	C45	450	CP16	428	CP50	429	DA60	641
BR142	475	BR68A	466	C46	450	CP17	428	CP56	432	DA61	641
BR146	474	BR68A	467	C48	451	CP18	429	CP57	438	DA65	642
BR15	488	BR68A-HVID	466	C5	448	CP2	426	CP58	438	DA65-4	642
BR153	473	BR68A-HVID	467	C50	435	CP200	64	CP59	434	DA7	622
BR16	489	BR68B	466	C51	435	CP200	332	CP6	423	DA70	642
BR160	476	BR68C	466	C52	447	CP200	456	CP61	434	DA71	642
BR161	476	BR68D	466	C53	447	CP201	64	CP62	434	DA72	642
BR163	476	BR68G	467	C54	447	CP201	332	CP63	434	DA73	642
BR180	477	BR68H	467	C56	452	CP201	456	CP7	427	DA8	621
BR181	477	BR68i	467	C57	452	CP202	64	CP72	433	DA9	620
BR1-M10-M20	482	BR68J	467	C59	453	CP202	332	CP72	763	DM1	631
BR1-M24	482	BR7	486	C5i	432	CP202	456	CP74	433	DM10	631
BR1-M3-M8	481	BR700	373	C5i	448	CP203	64	CP74	763	DM12	631
BR201	479	BR701	373	C6	444	CP203	332	CP75	433	DM2	631
BR212	478	BR702	373	C60	453	CP203	457	CP75	763	DM20	632
BR213	479	BR71	469	C61	453	CP204	64	CP76	432	DM21	632
BR214	212	BR71-1	469	C62	453	CP204	332	CP8	423	DM22	632
BR214	478	BR71A	470	C7	445	CP204	457	CP82	436	DM23	632
BR218	479	BR71B	470	C73	451	CP205	64	CP83	437	DM24	632
BR220	478	BR71D	470	C74	451	CP205	332	CP84	409	DM25	632
BR225	478	BR71E	470	C76	446	CP205	457	CP84	437	DM26	633
BR226	479	BR71G	470	C78	446	CP206	64	CP85	409	DM27	633
BR2-M2-M6	483	BR71I	470	C8	445	CP206	332	CP85	436	DM28	633
BR2-M8-M24	484	BR71J	470	C81	451	CP206	457	CP86	319	DM29	633
BR3	485	BR72A	471	C83	451	CP207	64	CP86	436	DM3	631
BR307	480	BR73A	471	C9	445	CP207	332	CP9	424	DM35	633
BR309	480	BR8	486	C92	451	CP207	457	CP90	439	DM36	633
BR317	478	BR9	486	C93	452	CP208	64	CP91	439	DM39	637
BR319	478	BTW1	111	C94	452	CP208	332	CP92	439	DM4	631
BR320	478	BTW2	111	C95	452	CP208	457	CP93	438	DM40	635
BR321	480	BTW3	111	C96	453	CP209	65	CP97	440	DM41	635
BR321	490	BTW4	111	CP1	422	CP209	333	CU1-1	169	DM42	635
BR322	480	C1	443	CP10	425	CP209	457	CU1-1	325	DM43	635
BR322	490	C10	445	CP100	433	CP21	430	CU1-1	463	DM44	636
BR323	479	C103	445	CP11	425	CP210	65	CV1	364	DM45	636
BR323	489	C11	445	CP12	427	CP210	333	CV2	364	DM46	636
BR324	479	C12	445	CP13	427	CP210	458	CV3	364	DM47	636
BR324	489	C123	450	CP130	437	CP211	65	CV4	365	DM48	636
BR325	480	C13	444	CP131	436	CP211	333	D1001	608	DM49	636
BR325	490	C145	732	CP132	409	CP211	458	D2001	608	DM50	636
BR327	477	C146	732	CP132	437	CP212	65	D3001	609	DM51	636
BR328	479	C15	446	CP133	437	CP212	333	D4000	609	DM52	636
BR328	489	C15G	446	CP134	437	CP212	458	D6002	609	DM53	637
BR329	472	C16	447	CP135	438	CP213	65	DA1	620	DM54	637
BR334	480	C17	447	CP136	440	CP213	333	DA10	621	DM55	637
BR334A	480	C19	448	CP137	436	CP213	458	DA12	621	DM56	637
BR335	480	C2	443	CP138	438	CP214	65	DA2	620	DM57	637
BR363	479	C20	448	CP139	438	CP214	333	DA22	622	DM58	637

DM59	637	E10480418	323	E1555	575	E283	504	E334	758	E465B	315
DM60	637	E10485418	167	E1557	575	E29	282	E336	758	E465C	315
DM61	638	E10485418	323	E1560	571	E2961	741	E337	758	E465D	316
DM63	638	E105	273	E1560-2	571	E2963	741	E338	758	E465E	316
DM64	638	E10500418	167	E1561	571	E3	281	E339	756	E465G	316
DM65	638	E10500418	323	E1562	571	E300	735	E33S	287	E465H	316
DM66	638	E105104	169	E1563	571	E300-1	736	E33S	328	E465I	316
DM67	638	E105104	325	E1565	575	E300G	737	E34	502	E465J	316
DM68	638	E10530618	168	E1567	571	E300GB	737	E341	740	E465K	316
DM69	638	E10530618	324	E1570	572	E300GP	738	E342	740	E465L	317
DM72	638	E105400607	168	E1572	572	E301	735	E35	502	E465M	317
DM73	639	E105400607	324	E1580	572	E30-1	285	E35-2	502	E465N	317
DM74	639	E10550418	169	E1581	574	E30-10	286	E35-3	503	E465O	317
DM75	639	E10550418	325	E1582	573	E301-1	736	E35-4	503	E465P	317
DM76	639	E106	273	E1583	573	E301G	737	E36	463	E465R	317
DM77	639	E106804	170	E16-10i	521	E301GB	737	E36	575	E465S	317
DM78	639	E106804	326	E16-19	521	E301GP	738	E360	766	E465T	317
DM79	639	E107	273	E16-20i	521	E302	735	E361	766	E4R	279
DM80	639	E107404	170	E16-29	202	E30-20	286	E37	504	E5	281
DM81	639	E107404	326	E16-29	522	E302-1	736	E370	670	E50	274
DM82	640	E107604	170	E16-30i	521	E30-3	285	E370	724	E51	275
DM83	640	E107604	326	E16-39	522	E30-30	286	E370	741	E5100	743
DM84	640	E10770427	170	E16-9	521	E305	737	E370	766	E5100-1	743
DM90	634	E10770427	326	E17	284	E30-5	285	E38	504	E5100-2	743
DM91	634	E107804	168	E1750	544	E306	737	E4	281	E52	275
DM92	634	E107804	324	E1751	544	E30-61	286	E400	743	E53	275
DM93	634	E108	273	E1753	544	E30-61	329	E408	742	E54	275
DM94	634	E109	273	E1757	544	E30-71	286	E409	742	E55	275
DM95	634	E11	282	E1759	544	E30-71	329	E411	773	E56	276
DM96	634	E110	273	E17R	280	E30-81	286	E412	773	E57	276
DM97	634	E11061012	170	E18	284	E30-81	329	E413	773	E58	276
DM98	635	E11061012	326	E1800	546	E30S	286	E414	773	E59	276
E1	281	E111	273	E1801	546	E30S	328	E425	314	E6	282
E10	282	E112	270	E1802	546	E31	502	E425	782	E60	276
E100	272	E113508	170	E1803	546	E310	738	E43	286	E6050	308
E100	278	E113508	326	E1810	547	E3100	743	E436	766	E6060	743
E100	286	E114215	170	E1820	547	E3107	743	E450C	312	E6060	782
E101	272	E114215	326	E1880	572	E310A	739	E455	314	E6062	766
E101	278	E114515	170	E18R	280	E311	738	E455A	314	E6063	766
E101	286	E114515	326	E19	284	E311A	739	E455B	315	E61	277
E102	272	E12	282	E19R	280	E311V	738	E455C	314	E62	277
E102	278	E1220	574	E1R	279	E312	738	E455D	314	E63	277
E102	286	E13	283	E2	281	E312A	739	E455E	315	E6310	745
E102004	169	E13	501	E20	284	E31S	287	E455G	314	E6330	745
E102004	325	E13F	283	E2090	735	E31S	328	E455H	315	E6350	745
E10220418	169	E13F	502	E2091	735	E32	502	E455J	315	E6400	745
E10220418	325	E13K	283	E2092	735	E320	739	E455M	315	E6410	745
E10230418	169	E13K	500	E2093	735	E321	757	E460	311	E6420	745
E10230418	325	E13R	283	E2094	735	E321G	757	E460A	311	E6450	745
E10240418	169	E13R	501	E20R	280	E322	756	E460B	311	E6500	746
E10240418	325	E13V	284	E21	284	E323	756	E460C	312	E6550	746
E102604	168	E13V	502	E22	284	E323-2	756	E460D	312	E6560	746
E102604	324	E14	283	E23	285	E324	758	E460DA	312	E6570	746
E10280418	168	E15	283	E23A	285	E324F	758	E460E	312	E66	274
E10280418	324	E1511	572	E24	284	E325	739	E460F	315	E6600	187
E10290418	168	E1522	572	E24A	285	E325B	739	E460G	312	E6600	745
E10290418	324	E1530	574	E24R	280	E326	758	E460H	313	E66C	275
E103	272	E1540	573	E25	285	E328	757	E460I	313	E67	277
E104	272	E1541	574	E26	285	E329	756	E460J	313	E6700	746
E104604	168	E1550	573	E26R	280	E32S	287	E460K	313	E6710	746
E104604	324	E1550-2	573	E27	285	E32S	328	E460L	313	E6720	746
E104654	168	E1551	574	E27R	280	E33	502	E460M	313	E6900	746
E104654	324	E1552	572	E28	285	E330	739	E465	317	E6910	746
E10480418	167	E1552-2	572	E282	504	E333	756	E465A	315	E6915	746

E6920	746	EA26	305	EC131C	767	EC26	292	EC99	258	ET14	501
E6R	279	EA3	298	EC131CA	267	EC27	293	ECM111	260	ET14	573
E7	282	EA4-12	304	EC131CA	768	EC28	293	ECM111-2	260	ET1900	742
E71	278	EA4-14	303	EC131K	267	EC29	289	ECM145	260	ET1901	743
E72	277	EA4-18	303	EC131K	767	EC3	288	ECM182C	260	ET1902	742
E73	278	EA4-38	303	EC131KA	267	EC30	292	ECM80RK	259	ET1903	742
E74	281	EA5	300	EC131KA	768	EC302	736	ECM81C	259	ET1904	742
E74	410	EA6-1	299	EC132	267	EC31	292	ECM82C	259	ET1905	742
E75	281	EA6-2	299	EC133C	181	EC310	738	ECM84C	260	ET2	109
E75	410	EA6-3	299	EC133C	258	EC311	738	ECM84K	259	ET2	504
E76C	276	EA6-4	299	EC134	258	EC32	294	ECM88	259	ET2949	741
E76K	276	EA6-5	299	EC135	181	EC33	293	ECM89C	260	ET2953	741
E77C	277	EA6-6	299	EC135	258	EC34	293	ECM92C	260	ET2970	741
E77K	276	EA7	301	EC137	251	EC35	293	ECM94	260	ET2980	739
E78	277	EA8	301	EC138	251	EC36	293	ECM96	260	ET2990	741
E7R	282	EA9	301	EC139	257	EC37	291	ECM97	259	ET3	109
E8	282	EC1	288	EC139K	258	EC38	288	EF81	67	ET3	504
E80	269	EC10	292	EC14	294	EC39	288	EF84	67	ET300	737
E81	269	EC100	252	EC140C	256	EC4	288	EF89	67	ET3997	741
E82	269	EC103C	252	EC140K	256	EC40	289	EF94	67	ET4	109
E83	270	EC103K	252	EC141C	256	EC41	290	EF97	67	ET4	504
E84	270	EC104K	248	EC141K	256	EC42	290	EFE31	287	ET5	109
E85	270	EC106	258	EC142C	257	EC43	290	EFK30	287	ET5	504
E86	270	EC106-2	258	EC142K	257	EC44	289	EFT31	287	ETW1	111
E87	270	EC11	292	EC143C	256	EC45	289	EG1	103	ETW10	112
E88	270	EC111	251	EC143K	255	EC46	289	EG2	103	ETW11	112
E8850	307	EC112C	252	EC144	251	EC5	289	EG3	103	ETW12	112
E8860	307	EC112K	252	EC15	291	EC50	289	EG4	103	ETW2	111
E89	271	EC113C	251	EC16	294	EC51	289	EG5	103	ETW3	111
E8952	307	EC113K	251	EC170K	250	EC52	294	EG5	104	ETW4	111
E8957	307	EC114	251	EC171C	250	EC54	294	EG6	103	ETW5	112
E8962	307	EC115	257	EC172K	253	EC55	294	EG7	103	ETW6	112
E8967	307	EC116C	257	EC173C	253	EC6	290	EG8	103	ETW7	112
E8972	307	EC116K	256	EC174K	254	EC7	290	EG9	103	ETW8	112
E8977	307	EC117	257	EC175C	254	EC8	291	EH80	334	ETW9	112
E8R	279	EC118	258	EC176K	254	EC80K	243	EH81	334	EV1	779
E9	282	EC119	246	EC177C	255	EC80RK	243	EH83	334	EV10	781
E90	271	EC12	293	EC178K	255	EC81C	243	EH84	334	EV10-2	781
E91	271	EC120C	261	EC179C	255	EC82C	244	EH85	334	EV11	781
E92	271	EC120K	261	EC18	294	EC82K	244	EH97	334	EV11-2	781
E93	271	EC121	261	EC180C	248	EC83K	243	EL1	740	EV12	781
E94	271	EC122C	264	EC181	252	EC84C	245	EL2	741	EV13	781
E96	272	EC122K	264	EC19	290	EC84K	244	EL300	737	EV14	782
E97	272	EC123C	265	EC190K	262	EC84LC	246	EO20-NC	774	EV14-2	782
E98	272	EC123K	265	EC191C	262	EC84LK	246	EO21-NC	774	EV14-3	783
E99	272	EC124	265	EC192K	262	EC85LC	245	EO21-NO	775	EV15	783
E9K	282	EC125C	265	EC193	262	EC85LK	245	EO22-NC	775	EV15-2	783
E9KR	279	EC125K	265	EC194C	263	EC87C	246	EO22-NO	775	EV16	781
E9MS	572	EC126C	268	EC194K	263	EC88	244	EO23-NC_230V	776	EV17	781
EA1	296	EC126K	268	EC196	307	EC89C	248	EO23-NC_24V	776	EV18	783
EA10	301	EC127C	268	EC197	307	EC89K	248	EO24-NC	774	EV2	779
EA11	299	EC127K	268	EC198K	308	EC8F	291	EO25	776	EV20	783
EA11	305	EC128	268	EC1F	288	EC9	291	EO26	777	EV21	651
EA13	299	EC129	258	EC2	289	EC90C	249	EO27	775	EV21	653
EA13	301	EC13	293	EC20	292	EC90K	249	EO27	776	EV21	677
EA14	304	EC130C	266	EC200	247	EC91	250	EO28	776	EV21	779
EA15	304	EC130C	767	EC201	247	EC92C	249	EO28-1	776	EV21	784
EA16	304	EC130CA	267	EC202	247	EC92K	249	EO29	776	EV22	314
EA17	304	EC130CA	767	EC203	247	EC93	250	EO30-HT	775	EV2-2	779
EA18	304	EC130K	266	EC21	291	EC94	247	EOEX27	775	EV3	780
EA2	297	EC130K	767	EC22	292	EC95	250	ET1	109	EV33	777
EA20	304	EC130KA	267	EC23	294	EC96	258	ET1	504	EV4	780
EA21	305	EC130KA	767	EC24	294	EC97	244	ET13	501	EV4-2	780
EA25	305	EC131C	267	EC25	292	EC98	252	ET13	573	EV5	651

EV5	653	FA41	322	FP2	549	GC4	179	GK155	55	J20150316	527
EV5	779	FA42	322	FP20	550	GC42	179	GK156	56	J20170316	527
EV5	784	FA43	322	FP21	550	GC43	179	GK158	56	J20180316	527
EV6	780	FA44	322	FP22	550	GC44	179	GK160	58	J20300316	526
EV6-2	780	FA5	713	FP23	551	GC45	179	GK161	58	J20310316	526
EZ1	580	FA70	722	FP24	551	GC46	185	GK165	58	J20340316	526
EZ10	581	FA71	722	FP25	551	GC47	185	GK167	58	J20350316	526
EZ11	581	FA72	723	FP26	551	GC48	181	GK168	58	J20370316	526
EZ12	581	FA73	723	FP4	550	GC49	181	GK169	58	J20380316	526
EZ12	736	FA9	722	FP5	550	GC5	179	GK170	58	J30	116
EZ2	580	FAD1	715	FP6	551	GC50	181	GK171	59	J30	537
EZ3	580	FAD20	715	FP7	549	GC50-1	184	GK173	58	J30100316	528
EZ4	580	FAD21	715	FP9	549	GC51	181	GK176	55	J30110316	528
EZ5	580	FAD-KIT	715	G110L	186	GC5-1	184	GK179	59	J30140316	528
EZ6	581	FAM1	714	G110V	186	GC51-1	184	GK182	59	J30300316	528
EZ8	581	FAM10	714	G150L	186	GC52	181	GK184	59	J30310316	528
EZ9	501	FAM11	714	G150V	186	GC52-1	184	GK198	59	J30340316	528
EZ9	581	FAPP	711	G200L	186	GC60	188	GK199	59	J40	530
F2527	412	FB1	717	G200V	186	GC61	188	GK200	60	J41	531
F2566	411	FB-1	717	G48	185	GC62	188	GK203	60	J45070402	541
F2576	413	FB-1	718	G49	185	GC63	188	GK204	60	J46	532
F2633	414	FB2	717	G50	187	GC64	188	GK36	60	J5000-FOOD	68
F2642	415	FB-2	717	G51	185	GC7	180	GK36	463	J5000-FOOD	511
FA0-1	712	FB-2	718	GC1	178	GC7	311	GK36	561	J5000-FOOD	540
FA0-1	713	FB20	717	GC10	180	GC7-1	184	GP1	567	J7020-FOOD	68
FA0-1	716	FBS4	718	GC11	180	GC8	180	GP2	567	J7020-FOOD	533
FA0-2	712	FBS40	718	GC1-1	184	GC9	180	GP3	567	J7020-FOOD	541
FA0-2	713	FF20M	714	GC13	173	GC90-1	187	H1	491	J7023-FOOD	68
FA0-2	716	FF23M	714	GC13-1	182	GC90-2	187	H1	628	J7023-FOOD	533
FA0-3	712	FF51M	714	GC14	173	GC9-1	184	H2	492	J7023-FOOD	541
FA0-3	713	FF52M	714	GC14-0	182	GG30	667	H2	629	J7024-FOOD	68
FA0-3	716	FF62M	714	GC15	173	GG33	667	H3	492	J7024-FOOD	533
FA1	710	Fi2	723	GC15-1	182	GK101	55	H3	629	J7024-FOOD	541
FA11	720	Fi2	748	GC17-1	182	GK104	55	H4	492	JA1	533
FA18-100	720	Fi2	769	GC18	174	GK116	56	H4	629	JA10B	535
FA18-10032	721	Fi20	724	GC18-0	182	GK119	56	H5	493	JA10G	535
FA18-120	720	Fi21	724	GC18-1	182	GK123	54	H5	630	JA11	531
FA18-12032	721	Fi3	723	GC19	174	GK124	54	H6	493	JA12	536
FA18-150	720	Fi4	723	GC19-1	182	GK125	54	H6	630	JA1-2	533
FA18-15032	721	Fi5	724	GC2	178	GK126	56	J00310402	523	JA14	535
FA18-20032	721	Fi6	724	GC21	175	GK127	55	J1	478	JA15	536
FA18-32	720	Fi7	723	GC22	175	GK128	55	J10100316	525	JA16	531
FA18-50	720	Fi8	723	GC22-1	183	GK129	55	J10110316	525	JA17	534
FA18-80	720	Fi9	723	GC23	175	GK130	56	J10140316	525	JA19	543
FA18-8032	721	FL10	191	GC23-1	183	GK131	57	J10150316	525	JA2	108
FA2	710	FL2	189	GC24	175	GK132	57	J10170316	525	JA2	533
FA20	711	FL3	189	GC24-1	183	GK133	59	J10180316	525	JA21	542
FA21	711	FL4	190	GC25	176	GK134	57	J10300316	524	JA23	536
FA22	713	FL5	190	GC25	319	GK135	56	J10310316	524	JA24B	538
FA23	712	FL6	191	GC26	176	GK136	56	J10340316	524	JA24G	538
FA24	712	FL7	190	GC26-1	183	GK137	56	J10350316	524	JA26	534
FA25	720	FL8	191	GC27	176	GK138	57	J10370316	524	JA28	531
FA29	321	FP1	549	GC27-1	183	GK140	57	J10380316	524	JA3	69
FA30	321	FP10	551	GC28	176	GK143	57	J10400402	334	JA3	534
FA31	322	FP11	549	GC28-1	183	GK144	57	J11	545	JA3	541
FA32	321	FP12	549	GC29	177	GK145	58	J12	532	JA32	534
FA33	322	FP13	549	GC29-1	184	GK146	57	J12-2	539	JA33	539
FA34	321	FP14	549	GC3	178	GK147	56	J17P	537	JA34	539
FA35	322	FP14-R	549	GC30	177	GK148	55	J19	530	JA4	531
FA36	321	FP15	550	GC30-1	184	GK149	54	J2	478	JA40-FOOD	68
FA37	322	FP16	550	GC31	177	GK150	54	J20	531	JA40-FOOD	540
FA38	322	FP17	550	GC3-1	184	GK152	57	J20100316	527	JA41-FOOD	68
FA39	322	FP18	550	GC31-1	184	GK153	55	J20110316	527	JA41-FOOD	540
FA40	322	FP19	550	GC32	177	GK154	54	J20140316	527	JA6	534

JA7	541	JT63	362	K4	105	MA122	126	MA205	121	MA272	353
JA8	543	JT64	144	K5	105	MA122	344	MA205	339	MA272	357
JA9	539	JT64	362	K6	105	MA123	126	MA211	123	MA273	136
JB20	599	JT65	144	K7	105	MA123	344	MA211	341	MA273	354
JB21	599	JT65	362	LA21	115	MA124	126	MA212	123	MA274	135
JB22	597	JT66	144	LB1	116	MA124	344	MA212	341	MA274	353
JB22R	597	JT66	362	LB2	117	MA125	126	MA213	123	MA275	136
JB23	596	JT67	144	LB2	396	MA125	344	MA213	341	MA275	139
JB23R	596	JT67	362	LB2	498	MA131	128	MA214	123	MA275	354
JB24	596	JT68	144	LB20	115	MA131	346	MA214	341	MA275	357
JB24R	597	JT68	362	LB21	115	MA132	128	MA215	123	MA281	124
JB25	598	JT69	144	LB22	115	MA132	346	MA215	341	MA281	342
JB26	598	JT69	362	LB3	117	MA133	128	MA221	126	MA282	124
JB27	600	JT70	144	LB3	396	MA133	346	MA221	344	MA282	342
JB28	600	JT70	362	LB3	499	MA134	128	MA222	126	MA283	124
JB29	601	JT71	144	LB4	116	MA134	346	MA222	344	MA283	342
JB30	602	JT71	362	LG1	116	MA135	128	MA223	127	MA284	125
JB31	603	JT72	145	LG2	117	MA135	346	MA223	345	MA284	343
JB32	603	JT72	363	LG2	498	MA141	130	MA224	126	MA285	125
JB33	605	JT73	145	LG2	505	MA141	348	MA224	344	MA285	343
JB34	605	JT73	363	LG2	570	MA142	130	MA225	127	MA412	137
JB35	605	JT74	145	LG3	117	MA142	348	MA225	345	MA412	355
JB37	598	JT74	363	LG3	499	MA143	130	MA231	128	MA415	137
JB45	600	JT76	145	LG3	505	MA143	348	MA231	346	MA415	355
JB48	601	JT76	363	LG3	570	MA144	130	MA232	128	MA416	137
JB49	603	JT77	145	LM20	115	MA144	348	MA232	346	MA416	355
JB62	604	JT77	363	LM22	115	MA145	130	MA233	129	MA418	137
JB63	604	JT78	145	M1	464	MA145	348	MA233	347	MA418	355
JM1	532	JT78	363	M300	141	MA161	132	MA234	128	MA511	137
JS2	545	JT80	145	M300	359	MA161	350	MA234	346	MA511	355
JS3	545	JT80	363	M301	141	MA162	132	MA235	129	MA512	137
JS4	545	JT80	530	M301	359	MA162	350	MA235	347	MA512	355
JS5	545	JT81	145	M309	141	MA163	132	MA241	130	MA513	137
JT50	134	JT81	363	M309	359	MA163	350	MA241	348	MA513	355
JT50	143	JT81	530	M310	141	MA164	132	MA242	130	MA628	138
JT50	352	K1	105	M310	359	MA164	350	MA242	348	MA628	356
JT50	361	K19	383	MA101	121	MA165	132	MA243	131	MA661	138
JT51	134	K2	105	MA101	339	MA165	350	MA243	349	MA661	356
JT51	143	K20	383	MA102	121	MA181	124	MA244	130	MA662	138
JT51	352	K21-1	382	MA102	339	MA181	342	MA244	348	MA662	356
JT51	361	K21-2	382	MA104	121	MA182	124	MA245	131	MA664	138
JT52	134	K21-3	382	MA104	339	MA182	342	MA245	349	MA664	356
JT52	143	K21-4	382	MA105	121	MA183	124	MA261	132	MA665	138
JT52	352	K22	382	MA105	339	MA183	342	MA261	138	MA665	356
JT52	361	K23	191	MA111	122	MA184	124	MA261	350	MA671	139
JT53	134	K24	625	MA111	340	MA184	342	MA261	356	MA671	357
JT53	143	K25	386	MA112	122	MA185	124	MA262	132	MA672	139
JT53	352	K25	758	MA112	340	MA185	342	MA262	138	MA672	357
JT53	361	K29	382	MA113	122	MA191	135	MA262	350	MA674	139
JT54	134	K3	105	MA113	340	MA191	353	MA262	356	MA674	357
JT54	143	K30	383	MA114	122	MA192	135	MA263	133	MA675	139
JT54	352	K31-1	382	MA114	340	MA192	353	MA263	351	MA675	357
JT54	361	K31-2	382	MA115	122	MA193	135	MA264	132	MA701	140
JT55	134	K31-3	382	MA115	340	MA193	353	MA264	350	MA701	358
JT55	143	K31-4	383	MA116	122	MA194	135	MA265	133	MA702	140
JT55	352	K31-5	383	MA116	340	MA194	353	MA265	138	MA702	358
JT55	361	K31-6	383	MA117	123	MA195	135	MA265	351	MA704	140
JT60	144	K32	383	MA117	341	MA195	353	MA265	356	MA704	358
JT60	362	K33	381	MA118	122	MA201	121	MA271	135	MA801	140
JT61	144	K34	381	MA118	340	MA201	339	MA271	139	MA801	358
JT61	362	K35	381	MA119	122	MA202	121	MA271	353	MA802	140
JT62	144	K36	381	MA119	340	MA202	339	MA271	357	MA802	358
JT62	362	K37	381	MA121	126	MA204	121	MA272	135	MA804	140
JT63	144	K38	381	MA121	344	MA204	339	MA272	139	MA804	358

MG1	108	N7-1	586	OP179	670	OP820	686	PC27	371	R5-2	384
MG2	108	N8-1	586	OP190	666	OP850	686	PC28	371	R5-4	384
MG3	108	N9-1	586	OP191	666	OP860	686	PC29	371	R5-5	384
MG4	108	OP100	664	OP192	666	OP890	686	PC3	368	R5-7	384
MG5	108	OP1000	690	OP194-FLOAT	666	OP90	648	PC30	371	R6-1	386
MG6	108	OP1002	690	OP200-NBR-H	660	OP90	658	PC31	371	R6-10	387
MG7	108	OP1004	689	OP202-NBR	660	OP900	687	PC32	372	R6-11	387
MST1	113	OP1006	689	OP204-NBR-H	662	OP901	687	PC35	372	R6-2	386
MST2	113	OP1008	691	OP206-KIT	661	OP91	648	PC37	372	R6-3	386
MST3	113	OP1010	691	OP206-NBR	661	OP91	658	PC38	372	R6-4	386
MST4	114	OP1012	692	OP208-NBR	662	OP910	688	PC4	368	R6-5	387
MST5	114	OP1014	692	OP20-EPDM	645	OP911	688	PC5	369	R6-6	387
MST6	114	OP1016	693	OP20-NBR	657	OP920	688	PC6	369	R6-7	387
MST7	114	OP1020	693	OP250-NBR-H	663	OP921	688	PC7	369	R6-8	387
MST8	114	OP1022	693	OP290	663	OP92-1	649	PC71	372	R6-9	387
N10-1	586	OP1024	694	OP292	663	OP92-1	658	PC8	369	s1001	626
N10-2	587	OP1030	694	OP300-EPDM	650	OP92-2	649	PC80	372	s1002	626
N10-3	587	OP1032	694	OP302-EPDM	650	OP92-2	659	PC80	377	s1002-1	626
N10-4	586	OP1036	695	OP304-EPDM	651	OP92-3	649	PC81	372	s1002-4	626
N10-5	587	OP1040	695	OP306-EPDM	651	OP92-3	659	PC9	369	s1002-6	626
N1-1	584	OP1042	696	OP350-EPDM	652	OP93	648	PF2642	415	s1002-7	626
N11-1	587	OP1050	696	OP352-EPDM	653	OP94	649	PG1	374	s1004-1	625
N11-4	587	OP10-EPDM-H	645	OP354-EPDM	653	OP94	659	PG10	375	S1005	627
N1-2	585	OP10-NBR-H	656	OP358-EPDM	652	OP95	649	PG13	376	s1005-1	627
N12-1	587	OP110	664	OP360-EPDM	654	OP95	659	PG18	375	s1006-1	627
N12-2	587	OP1110	697	OP390	654	PA100	212	PG2	374	s1006-3	625
N12-3	587	OP1112	697	OP40-EPDM	646	PA25	233	PG22	376	s1006-4	625
N1-3	585	OP1114	698	OP42-EPDM	646	PA26	233	PG27	376	s1006-5	625
N13-1	588	OP1116	698	OP44-EPDM	647	PA27	233	PG28	376	s1006-6	625
N13-2	588	OP1118	698	OP46-EPDM	647	PA28	233	PG29	376	s1006-7	627
N13-3	588	OP11-NBR-H	656	OP50-EPDM	646	PA29	233	PG3	374	s1006-8	625
N1-4	585	OP120	665	OP514-24V	674	PA30	233	PG30	377	S1010	311
N14-1	590	OP1200	699	OP516-24V	674	PA31	234	PG31	377	S1010	319
N14-2	590	OP1202	699	OP518-230V	675	PA35	234	PG4	375	S1010	523
N14-3	590	OP1204	700	OP520-230V	675	PA36	234	PG43	375	S1010	783
N14-4	590	OP121	665	OP522	673	PA38	234	PG6	375	SAF8063	223
N14-5	590	OP130	668	OP524	673	PA39	234	PG7	375	SAF8063	417
N14-6	590	OP1302	705	OP530-24V	674	PA45	236	PG9	375	VS10	335
N14-7	590	OP1304	705	OP532-230V	674	PA49	236	PR60	378	VS4	335
N15	590	OP1306	706	OP534	673	PA50	236	PR61	378	VS5	335
N16-1	591	OP1308	706	OP552	676	PA54	237	PR62	378	VS6	335
N16-2	591	OP1310	703	OP554	676	PA55	237	PR64	378	AA1	748
N16-3	591	OP1314	701	OP570	677	PA57	237	PR66	378	AA2	748
N16-4	591	OP1316	702	OP572	677	PA60	237	PR67	378	AA3	748
N16-5	591	OP135	667	OP574	677	PA65	237	PTW4	112	AA381	759
N16-6	591	OP140	667	OP576	677	PA65	239	R1	381	AA382	759
N16-7	591	OP140	765	OP578	677	PA70	238	R2	380	AA383	759
N17	594	OP1408	707	OP600	678	PA72	238	R21	385	AA384	759
N18	544	OP1409	707	OP60-EPDM	647	PA74	238	R2-1	380	AA385	759
N18	594	OP1410	708	OP610	678	PA78	238	R22	385	AA4	748
N18-2	544	OP1418	708	OP620	679	PA79	238	R2-2	380		
N18-2	594	OP1419	708	OP630	679	PA90	237	R23	385		
N19	587	OP1420	708	OP640	680	PA90	239	R24	385		
N20	584	OP144	668	OP650	680	PC1	368	R25	385		
N21	584	OP144	765	OP660	680	PC1	463	R26	385		
N2-1	585	OP150	668	OP690	681	PC10	369	R27	385		
N2-2	585	OP150	764	OP692	681	PC13	370	R28	385		
N2-3	585	OP152	669	OP700-EPDM	684	PC14	370	R29	386		
N3-1	585	OP152	764	OP720-EPDM	682	PC18	370	R3	381		
N4-1	585	OP160	668	OP721-EPDM	683	PC19	370	R4	381		
N5-1	585	OP170	669	OP730-EPDM	683	PC2	368	R4-2	382		
N5-2	586	OP170-B	670	OP731-EPDM	684	PC20	370	R4-3	381		
N5-3	586	OP172	669	OP800	685	PC21	370	R4-4	382		
N6-1	586	OP172-B	670	OP810	686	PC23	370	R4-5	382		

